

ZyWALL 70

Internet Security Appliance

User's Guide

Version 3.64
3/2005



Copyright

Copyright © 2005 by ZyXEL Communications Corporation.

The contents of this publication may not be reproduced in any part or as a whole, transcribed, stored in a retrieval system, translated into any language, or transmitted in any form or by any means, electronic, mechanical, magnetic, optical, chemical, photocopying, manual, or otherwise, without the prior written permission of ZyXEL Communications Corporation.

Published by ZyXEL Communications Corporation. All rights reserved.

Disclaimer

ZyXEL does not assume any liability arising out of the application or use of any products, or software described herein. Neither does it convey any license under its patent rights nor the patent rights of others. ZyXEL further reserves the right to make changes in any products described herein without notice. This publication is subject to change without notice.

Trademarks

ZyNOS (ZyXEL Network Operating System) is a registered trademark of ZyXEL Communications, Inc. Other trademarks mentioned in this publication are used for identification purposes only and may be properties of their respective owners.

Federal Communications Commission (FCC) Interference Statement

This device complies with Part 15 of FCC rules. Operation is subject to the following two conditions:

- This device may not cause harmful interference.
- This device must accept any interference received, including interference that may cause undesired operations.

This equipment has been tested and found to comply with the limits for a Class B digital device pursuant to Part 15 of the FCC Rules. These limits are designed to provide reasonable protection against harmful interference in a commercial environment. This equipment generates, uses, and can radiate radio frequency energy, and if not installed and used in accordance with the instructions, may cause harmful interference to radio communications.

If this equipment does cause harmful interference to radio/television reception, which can be determined by turning the equipment off and on, the user is encouraged to try to correct the interference by one or more of the following measures:

- Reorient or relocate the receiving antenna.
- Increase the separation between the equipment and the receiver.
- Connect the equipment into an outlet on a circuit different from that to which the receiver is connected.
- Consult the dealer or an experienced radio/TV technician for help.

Notice 1

Changes or modifications not expressly approved by the party responsible for compliance could void the user's authority to operate the equipment.

This Class B digital apparatus complies with Canadian ICES-003.

Cet appareil numérique de la classe B est conforme à la norme NMB-003 du Canada.

Certifications

Go to www.zyxel.com

- 1 Select your product from the drop-down list box on the ZyXEL home page to go to that product's page.
- 2 Select the certification you wish to view from this page.

Safety Warnings

For your safety, be sure to read and follow all warning notices and instructions.

- Do NOT open the device or unit. Opening or removing covers can expose you to dangerous high voltage points or other risks. ONLY qualified service personnel can service the device. Please contact your vendor for further information.
- Connect the power cord to the right supply voltage (110V AC in North America or 230V AC in Europe).
- Place connecting cables carefully so that no one will step on them or stumble over them. Do NOT allow anything to rest on the power cord and do NOT locate the product where anyone can walk on the power cord.
- If you wall mount your device, make sure that no electrical, gas or water pipes will be damaged.
- Do NOT install nor use your device during a thunderstorm. There may be a remote risk of electric shock from lightning.
- Do NOT expose your device to dampness, dust or corrosive liquids.
- Do NOT use this product near water, for example, in a wet basement or near a swimming pool.
- Make sure to connect the cables to the correct ports.
- Do NOT obstruct the device ventilation slots, as insufficient airflow may harm your device.
- Do NOT store things on the device.
- Connect ONLY suitable accessories to the device.

ZyXEL Limited Warranty

ZyXEL warrants to the original end user (purchaser) that this product is free from any defects in materials or workmanship for a period of up to two years from the date of purchase. During the warranty period, and upon proof of purchase, should the product have indications of failure due to faulty workmanship and/or materials, ZyXEL will, at its discretion, repair or replace the defective products or components without charge for either parts or labor, and to whatever extent it shall deem necessary to restore the product or components to proper operating condition. Any replacement will consist of a new or re-manufactured functionally equivalent product of equal value, and will be solely at the discretion of ZyXEL. This warranty shall not apply if the product is modified, misused, tampered with, damaged by an act of God, or subjected to abnormal working conditions.

Note

Repair or replacement, as provided under this warranty, is the exclusive remedy of the purchaser. This warranty is in lieu of all other warranties, express or implied, including any implied warranty of merchantability or fitness for a particular use or purpose. ZyXEL shall in no event be held liable for indirect or consequential damages of any kind of character to the purchaser.

To obtain the services of this warranty, contact ZyXEL's Service Center for your Return Material Authorization number (RMA). Products must be returned Postage Prepaid. It is recommended that the unit be insured when shipped. Any returned products without proof of purchase or those with an out-dated warranty will be repaired or replaced (at the discretion of ZyXEL) and the customer will be billed for parts and labor. All repaired or replaced products will be shipped by ZyXEL to the corresponding return address, Postage Paid. This warranty gives you specific legal rights, and you may also have other rights that vary from country to country.

Customer Support

Please have the following information ready when you contact customer support.

- Product model and serial number.
- Warranty Information.
- Date that you received your device.
- Brief description of the problem and the steps you took to solve it.

METHOD	SUPPORT E-MAIL	TELEPHONE ^A	WEB SITE	REGULAR MAIL
LOCATION	SALES E-MAIL	FAX	FTP SITE	
CORPORATE HEADQUARTERS (WORLDWIDE)	support@zyxel.com.tw	+886-3-578-3942	www.zyxel.com www.europe.zyxel.com	ZyXEL Communications Corp. 6 Innovation Road II Science Park Hsinchu 300 Taiwan
	sales@zyxel.com.tw	+886-3-578-2439	ftp.zyxel.com ftp.europe.zyxel.com	
CZECH REPUBLIC	info@cz.zyxel.com	+420 241 091 350	www.zyxel.cz	ZyXEL Communications Czech s.r.o. Modranská 621 143 01 Praha 4 - Modrany Ceská Republika
	info@cz.zyxel.com	+420 241 091 359		
DENMARK	support@zyxel.dk	+45 39 55 07 00	www.zyxel.dk	ZyXEL Communications A/S Columbusvej 5 2860 Soeborg Denmark
	sales@zyxel.dk	+45 39 55 07 07		
FINLAND	support@zyxel.fi	+358-9-4780-8411	www.zyxel.fi	ZyXEL Communications Oy Malminkaari 10 00700 Helsinki Finland
	sales@zyxel.fi	+358-9-4780 8448		
FRANCE	info@zyxel.fr	+33 (0)4 72 52 97 97	www.zyxel.fr	ZyXEL France 1 rue des Vergers Bat. 1 / C 69760 Limonest France
		+33 (0)4 72 52 19 20		
GERMANY	support@zyxel.de	+49-2405-6909-0	www.zyxel.de	ZyXEL Deutschland GmbH. Adenauerstr. 20/A2 D-52146 Wuerselen Germany
	sales@zyxel.de	+49-2405-6909-99		
NORTH AMERICA	support@zyxel.com	+1-800-255-4101 +1-714-632-0882	www.us.zyxel.com	ZyXEL Communications Inc. 1130 N. Miller St. Anaheim CA 92806-2001 U.S.A.
	sales@zyxel.com	+1-714-632-0858	ftp.us.zyxel.com	
NORWAY	support@zyxel.no	+47 22 80 61 80	www.zyxel.no	ZyXEL Communications A/S Niils Hansens vei 13 0667 Oslo Norway
	sales@zyxel.no	+47 22 80 61 81		
SPAIN	support@zyxel.es	+34 902 195 420	www.zyxel.es	ZyXEL Communications Alejandro Villegas 33 1º, 28043 Madrid Spain
	sales@zyxel.es	+34 913 005 345		
SWEDEN	support@zyxel.se	+46 31 744 7700	www.zyxel.se	ZyXEL Communications A/S Sjöporten 4, 41764 Göteborg Sweden
	sales@zyxel.se	+46 31 744 7701		

METHOD	SUPPORT E-MAIL	TELEPHONE ^A	WEB SITE	REGULAR MAIL
	SALES E-MAIL	FAX	FTP SITE	
UNITED KINGDOM	support@zyxel.co.uk	+44 (0) 1344 303044 08707 555779 (UK only)	www.zyxel.co.uk	ZyXEL Communications UK Ltd.,11 The Courtyard, Eastern Road, Bracknell, Berkshire, RG12 2XB, United Kingdom (UK)
	sales@zyxel.co.uk	+44 (0) 1344 303034	ftp.zyxel.co.uk	

a. "+" is the (prefix) number you enter to make an international telephone call.

Table of Contents

Copyright	3
Federal Communications Commission (FCC) Interference Statement	4
Safety Warnings	5
ZyXEL Limited Warranty	6
Customer Support	7
Table of Contents	9
List of Figures	27
List of Tables	39
Preface	47
Chapter 1	
Getting to Know Your ZyWALL	49
1.1 ZyWALL 70 Internet Security Appliance Overview	49
1.2 Physical Features	49
1.2.1 Non-Physical Features	51
1.3 Applications for the ZyWALL	56
1.3.1 Secure Broadband Internet Access via Cable or DSL Modem	56
1.3.2 VPN Application	56
1.3.3 Front Panel LEDs	57
Chapter 2	
Introducing the Web Configurator	59
2.1 Web Configurator Overview	59
2.2 Accessing the ZyWALL Web Configurator	59
2.3 Resetting the ZyWALL	60
2.3.1 Procedure To Use The Reset Button	61
2.3.2 Uploading a Configuration File Via Console Port	61
2.4 Navigating the ZyWALL Web Configurator	62
2.4.1 Router Mode	62
2.4.2 Bridge Mode	64
2.4.3 Navigation Panel	66
2.4.4 System Statistics	69
2.4.4.1 Show Statistics: Line Chart	70

2.4.5 DHCP Table Screen	71
2.4.6 VPN Status	72
Chapter 3	
Wizard Setup	75
3.1 Wizard Setup Overview	75
3.2 Internet Access	75
3.2.1 ISP Parameters	75
3.2.1.1 Ethernet	75
3.2.1.2 PPPoE Encapsulation	77
3.2.1.3 PPTP Encapsulation	78
3.2.2 Internet Access Wizard Setup Complete	80
3.3 VPN Wizard	81
3.3.1 Network Setting	83
3.3.2 IKE Tunnel Setting (IKE Phase 1)	85
3.3.3 IPSec Setting (IKE Phase 2)	87
3.3.4 VPN Status Summary	88
3.3.5 VPN Wizard Setup Complete	91
Chapter 4	
LAN Screens	93
4.1 LAN Overview	93
4.2 DHCP Setup	93
4.2.1 IP Pool Setup	93
4.3 LAN TCP/IP	93
4.3.1 Factory LAN Defaults	93
4.3.2 IP Address and Subnet Mask	94
4.3.3 RIP Setup	94
4.3.4 Multicast	95
4.4 DNS Servers	95
4.5 Configuring LAN	95
4.6 Configuring Static DHCP	98
4.7 Configuring IP Alias	99
Chapter 5	
Bridge Screens	103
5.1 Bridge Loop	103
5.2 Spanning Tree Protocol (STP)	103
5.2.1 Rapid STP	104
5.2.2 STP Terminology	104
5.2.3 How STP Works	104
5.2.4 STP Port States	105
5.3 Configuring Bridge	105

Chapter 6	
Wireless LAN	109
6.1 Introduction	109
6.1.1 Additional Installation Requirements for Using 802.1x	109
6.2 Wireless Security	109
6.3 Security Parameters Summary	110
6.4 WEP Encryption	111
6.5 802.1x Overview	111
6.6 Dynamic WEP Key Exchange	111
6.7 Introduction to WPA	112
6.7.1 User Authentication	112
6.7.2 Encryption	112
6.8 WPA-PSK Application Example	113
6.9 Introduction to RADIUS	113
6.10 WPA with RADIUS Application Example	114
6.11 Wireless Client WPA Supplicants	114
6.12 Configuring Wireless LAN	115
6.12.1 Static WEP	117
6.12.2 WPA-PSK	119
6.12.3 WPA	120
6.12.4 802.1x + Dynamic WEP	121
6.12.5 802.1x + Static WEP	123
6.12.6 802.1x + No WEP	124
6.12.7 No Access 802.1x + Static WEP	126
6.12.8 No Access 802.1x + No WEP	127
6.13 Configuring MAC Filter	127
6.13.1 EAP Authentication Overview	129
Chapter 7	
WAN Screens	131
7.1 WAN Overview	131
7.2 Multiple WAN	131
7.3 Load Balancing Introduction	132
7.4 Load Balancing Algorithms	132
7.4.1 Least Load First	132
7.4.1.1 Example 1	132
7.4.1.2 Example 2	133
7.4.2 Weighted Round Robin	134
7.4.3 Spillover	134
7.5 TCP/IP Priority (Metric)	135
7.6 Configuring General	135
7.7 Configuring Load Balancing	138
7.7.1 Least Load First	138

7.7.2 Weighted Round Robin	139
7.7.3 Spillover	140
7.7.3.1 WAN IP Address Assignment	141
7.7.3.2 DNS Server Address Assignment	142
7.7.3.3 WAN MAC Address	142
7.8 Configuring WAN Setup	143
7.8.1 Ethernet Encapsulation	143
7.8.2 PPPoE Encapsulation	146
7.8.3 PPTP Encapsulation	150
7.9 Traffic Redirect	153
7.10 Configuring Traffic Redirect	153
7.11 Configuring Dial Backup	154
7.12 Advanced Modem Setup	158
7.12.1 AT Command Strings	158
7.12.2 DTR Signal	158
7.12.3 Response Strings	158
7.13 Configuring Advanced Modem Setup	158
Chapter 8	
DMZ Screens	161
8.1 DMZ Overview	161
8.2 Configuring DMZ	161
8.3 Configuring IP Alias	163
8.4 DMZ Public IP Address Example	165
8.5 DMZ Private and Public IP Address Example	165
Chapter 9	
Firewalls	167
9.1 Firewall Overview	167
9.2 Types of Firewalls	167
9.2.1 Packet Filtering Firewalls	167
9.2.2 Application-level Firewalls	167
9.2.3 Stateful Inspection Firewalls	168
9.3 Introduction to ZyXEL's Firewall	168
9.4 Denial of Service	169
9.4.1 Basics	169
9.4.2 Types of DoS Attacks	170
9.4.2.1 ICMP Vulnerability	172
9.4.2.2 Illegal Commands (NetBIOS and SMTP)	172
9.4.2.3 Traceroute	173
9.5 Stateful Inspection	173
9.5.1 Stateful Inspection Process	174
9.5.2 Stateful Inspection and the ZyWALL	175

9.5.3 TCP Security	175
9.5.4 UDP/ICMP Security	176
9.5.5 Upper Layer Protocols	176
9.6 Guidelines For Enhancing Security With Your Firewall	177
9.7 Packet Filtering Vs Firewall	177
9.7.1 Packet Filtering:	177
9.7.1.1 When To Use Filtering	177
9.7.2 Firewall	178
9.7.2.1 When To Use The Firewall	178

Chapter 10

Firewall Screens 179

10.1 Access Methods	179
10.2 Firewall Policies Overview	179
10.3 Rule Logic Overview	180
10.3.1 Rule Checklist	180
10.3.2 Security Ramifications	181
10.3.3 Key Fields For Configuring Rules	181
10.3.3.1 Action	181
10.3.3.2 Service	181
10.3.3.3 Source Address	181
10.3.3.4 Destination Address	181
10.4 Connection Direction Examples	181
10.4.1 LAN To WAN Rules	182
10.4.2 WAN To LAN Rules	182
10.5 Alerts	183
10.6 Configuring Firewall	183
10.6.1 Rule Summary	186
10.6.2 Configuring Firewall Rules	187
10.6.3 Configuring Custom Services	190
10.7 Example Firewall Rule	190
10.8 Predefined Services	194
10.9 Anti-Probing	196
10.10 DoS Thresholds	197
10.10.1 Threshold Values	198
10.10.2 Half-Open Sessions	198
10.10.2.1 TCP Maximum Incomplete and Blocking Time	198

Chapter 11

Content Filtering Screens 201

11.1 Content Filtering Overview	201
11.1.1 Restrict Web Features	201
11.1.2 Create a Filter List	201

11.1.3 Customize Web Site Access	201
11.2 General Content Filter Configuration	201
11.3 Content Filtering with an External Database	204
11.4 Categories and Registering	204
11.5 Customization	211
11.6 Customizing Keyword Blocking URL Checking	214
11.6.1 Domain Name or IP Address URL Checking	214
11.6.2 Full Path URL Checking	214
11.6.3 File Name URL Checking	214
11.7 Content Filtering Cache	215
Chapter 12	
Content Filtering Registration and Reports.....	217
12.1 Introduction to myZyXEL.com	217
12.1.1 A Note on myZyXEL.com Numbers	218
12.2 myZyXEL.com Account Registration	218
12.3 Registering Your ZyXEL Device	220
12.4 Content Filtering Registration	223
12.5 Checking Content Filtering Activation	225
12.6 Updating Product Registration Information	226
12.7 Viewing Content Filtering Reports	226
12.8 Configuration File	228
Chapter 13	
Introduction to IPSec	229
13.1 VPN Overview	229
13.1.1 IPSec	229
13.1.2 Security Association	229
13.1.3 Other Terminology	229
13.1.3.1 Encryption	229
13.1.3.2 Data Confidentiality	230
13.1.3.3 Data Integrity	230
13.1.3.4 Data Origin Authentication	230
13.1.4 VPN Applications	230
13.1.4.1 Linking Two or More Private Networks Together	230
13.1.4.2 Accessing Network Resources When NAT Is Enabled	230
13.1.4.3 Unsupported IP Applications	230
13.2 IPSec Architecture	231
13.2.1 IPSec Algorithms	231
13.2.2 Key Management	231
13.3 Encapsulation	231
13.3.1 Transport Mode	232
13.3.2 Tunnel Mode	232

13.4 IPSec and NAT	232
Chapter 14	
VPN Screens	235
14.1 VPN/IPSec Overview	235
14.2 IPSec Algorithms	235
14.2.1 AH (Authentication Header) Protocol	235
14.2.2 ESP (Encapsulating Security Payload) Protocol	235
14.3 My ZyWALL	236
14.4 Remote Gateway Address	236
14.4.1 Dynamic Remote Gateway Address	237
14.5 Nailed Up	237
14.6 NAT Traversal	237
14.6.1 NAT Traversal Configuration	238
14.7 ID Type and Content	238
14.7.1 ID Type and Content Examples	239
14.8 IKE Phases	240
14.8.1 Negotiation Mode	241
14.8.2 Pre-Shared Key	241
14.8.3 Diffie-Hellman (DH) Key Groups	242
14.8.4 Perfect Forward Secrecy (PFS)	242
14.9 X-Auth (Extended Authentication)	242
14.9.1 Authentication Server	242
14.10 Icons Key	243
14.11 IPSec Fields Summary	243
14.12 IKE VPN Rule Summary Screen	244
14.12.1 Configuring an IKE Gateway Policy	245
14.12.2 Configuring an IKE Network Policy	251
14.12.2.1 Associating a Network Policy to a Gateway Policy	255
14.13 Manual VPN Rule Summary Screen	256
14.13.1 Editing Manual VPN Rules	258
14.13.2 Security Parameter Index (SPI)	258
14.14 Viewing SA Monitor	262
14.15 Configuring Global Setting	263
14.16 Telecommuter VPN/IPSec Examples	264
14.16.1 Telecommuters Sharing One VPN Rule Example	264
14.16.2 Telecommuters Using Unique VPN Rules Example	264
14.17 VPN and Remote Management	266
Chapter 15	
Certificates	267
15.1 Certificates Overview	267
15.1.1 Advantages of Certificates	268

15.2 Self-signed Certificates	268
15.3 Configuration Summary	268
15.4 My Certificates	269
15.5 Certificate File Formats	270
15.6 Importing a Certificate	271
15.7 Creating a Certificate	272
15.8 My Certificate Details	274
15.9 Trusted CAs	277
15.10 Importing a Trusted CA's Certificate	279
15.11 Trusted CA Certificate Details	280
15.12 Trusted Remote Hosts	283
15.13 Verifying a Trusted Remote Host's Certificate	285
15.13.1 Trusted Remote Host Certificate Fingerprints	285
15.14 Importing a Trusted Remote Host's Certificate	286
15.15 Trusted Remote Host Certificate Details	287
15.16 Directory Servers	290
15.17 Add or Edit a Directory Server	291
Chapter 16	
Authentication Server	293
16.1 Authentication Server Overview	293
16.1.1 Local User Database	293
16.1.2 RADIUS	293
16.2 Configuring Local User Database	293
16.3 Configuring RADIUS	295
Chapter 17	
Network Address Translation (NAT)	297
17.1 NAT Overview	297
17.1.1 NAT Definitions	297
17.1.2 What NAT Does	298
17.1.3 How NAT Works	298
17.1.4 NAT Application	299
17.1.5 Port Restricted Cone NAT	300
17.1.6 NAT Mapping Types	300
17.2 Using NAT	301
17.2.1 SUA (Single User Account) Versus NAT	301
17.3 Configuring NAT Overview	302
17.4 Configuring Address Mapping	303
17.4.1 Address Mapping Edit	305
17.5 Port Forwarding	306
17.5.1 Default Server IP Address	307
17.5.2 Port Forwarding: Services and Port Numbers	307

17.5.3 Configuring Servers Behind Port Forwarding (Example)	307
17.5.4 NAT and Multiple WAN	308
17.5.5 Port Translation	308
17.6 Configuring Port Forwarding	309
17.7 Configuring Trigger Port	311
Chapter 18	
Static Route	315
18.1 Static Route Overview	315
18.2 Configuring IP Static Route	315
18.2.1 Configuring a Static Route Entry	317
Chapter 19	
Policy Route	319
19.1 Introduction to IP Policy Routing	319
19.2 Benefits	319
19.3 Routing Policy	319
19.4 IP Routing Policy Setup	320
19.5 Configuring the IP Policy Route Entry	321
Chapter 20	
Bandwidth Management	325
20.1 Bandwidth Management Overview	325
20.2 Bandwidth Classes and Filters	325
20.3 Proportional Bandwidth Allocation	326
20.4 Application-based Bandwidth Management	326
20.5 Subnet-based Bandwidth Management	326
20.6 Application and Subnet-based Bandwidth Management	326
20.7 Scheduler	327
20.7.1 Priority-based Scheduler	327
20.7.2 Fairness-based Scheduler	327
20.8 Maximize Bandwidth Usage	327
20.8.1 Reserving Bandwidth for Non-Bandwidth Class Traffic	328
20.8.2 Maximize Bandwidth Usage Example	328
20.8.2.1 Priority-based Allotment of Unused and Unbudgeted Bandwidth	328
20.8.2.2 Fairness-based Allotment of Unused and Unbudgeted Bandwidth	329
20.9 Bandwidth Borrowing	329
20.9.1 Bandwidth Borrowing Example	330
20.9.2 Maximize Bandwidth Usage With Bandwidth Borrowing	330
20.10 Configuring Summary	331
20.11 Configuring Class Setup	332
20.11.1 Bandwidth Manager Class Configuration	334

20.11.2 Bandwidth Management Statistics	337
20.12 Configuring Monitor	338
Chapter 21	
DNS.....	341
21.1 DNS Overview	341
21.2 DNS Server Address Assignment	341
21.3 DNS Servers	341
21.4 Address Record	342
21.4.1 DNS Wildcard	342
21.5 Name Server Record	342
21.5.1 Private DNS Server	342
21.6 System Screen	343
21.6.1 Adding an Address Record	344
21.6.2 Inserting a Name Server record	345
21.7 DNS Cache	347
21.8 Configure DNS Cache	347
21.9 Configuring DNS LAN	348
21.10 Dynamic DNS	350
21.10.1 DYNDNS Wildcard	350
21.10.2 High Availability	350
21.11 Configuring Dynamic DNS	350
Chapter 22	
Remote Management.....	353
22.1 Remote Management Overview	353
22.1.1 Remote Management Limitations	353
22.1.2 Remote Management and NAT	354
22.1.3 System Timeout	354
22.2 Introduction to HTTPS	354
22.3 Configuring WWW	355
22.4 HTTPS Example	357
22.4.1 Internet Explorer Warning Messages	357
22.4.2 Netscape Navigator Warning Messages	358
22.4.3 Avoiding the Browser Warning Messages	359
22.4.4 Login Screen	359
22.5 SSH Overview	362
22.6 How SSH works	362
22.7 SSH Implementation on the ZyWALL	363
22.7.1 Requirements for Using SSH	364
22.8 Configuring SSH	364
22.9 Secure Telnet Using SSH Examples	365
22.9.1 Example 1: Microsoft Windows	365

22.9.2 Example 2: Linux	365
22.10 Secure FTP Using SSH Example	366
22.11 Telnet	367
22.12 Configuring TELNET	367
22.13 Configuring FTP	368
22.14 Configuring SNMP	369
22.14.1 Supported MIBs	371
22.14.2 SNMP Traps	371
22.14.3 REMOTE MANAGEMENT: SNMP	371
22.15 Configuring DNS	373
22.16 Introducing Vantage CNM	373
22.17 Configuring CNM	374
Chapter 23	
UPnP.....	377
23.1 Universal Plug and Play Overview	377
23.1.1 How Do I Know If I'm Using UPnP?	377
23.1.2 NAT Traversal	377
23.1.3 Cautions with UPnP	377
23.2 UPnP and ZyXEL	378
23.3 Configuring UPnP	378
23.4 Displaying UPnP Port Mapping	379
23.5 Installing UPnP in Windows Example	380
23.5.1 Installing UPnP in Windows Me	381
23.5.2 Installing UPnP in Windows XP	382
23.6 Using UPnP in Windows XP Example	382
23.6.1 Auto-discover Your UPnP-enabled Network Device	383
23.6.2 Web Configurator Easy Access	384
Chapter 24	
Logs Screens.....	387
24.1 Configuring View Log	387
24.2 Log Description Example	388
24.3 Configuring Log Settings	389
24.4 Configuring Reports	392
24.4.1 Viewing Web Site Hits	394
24.4.2 Viewing Protocol/Port	394
24.4.3 Viewing LAN IP Address	395
24.4.4 Reports Specifications	396
Chapter 25	
Maintenance	397
25.1 Maintenance Overview	397

25.2 General Setup	397
25.2.1 General Setup and System Name	397
25.2.2 Domain Name	397
25.3 Configuring Password	398
25.4 Pre-defined NTP Time Servers List	399
25.5 Configuring Time and Date	400
25.5.1 Resetting the Time	402
25.5.2 Time Server Synchronization	402
25.6	Introduction To Transparent Bridging 403
25.7 Transparent Firewalls	404
25.8 Configuring Device Mode	405
25.9 F/W Upload Screen	407
25.10 Configuration Screen	409
25.10.1 Backup Configuration	410
25.10.2 Restore Configuration	410
25.10.3 Back to Factory Defaults	412
25.11 Restart Screen	412

Chapter 26

Introducing the SMT 415

26.1 Introduction to the SMT	415
26.2 Accessing the SMT via the Console Port	415
26.2.1 Initial Screen	415
26.2.2 Entering the Password	416
26.3 Navigating the SMT Interface	416
26.3.1 Main Menu	417
26.3.2 SMT Menus Overview	419
26.4 Changing the System Password	421
26.5 Resetting the ZyWALL	422

Chapter 27

SMT Menu 1 - General Setup..... 423

27.1 Introduction to General Setup	423
27.2 Configuring General Setup	423
27.2.1 Configuring Dynamic DNS	425
27.2.1.1 Editing DDNS Host	425

Chapter 28

WAN and Dial Backup Setup..... 429

28.1 Introduction to WAN and Dial Backup Setup	429
28.2 WAN Setup	429
28.3 Dial Backup	430
28.4 Configuring Dial Backup in Menu 2	430

28.5 Advanced WAN Setup	431
28.6 Remote Node Profile (Backup ISP)	433
28.7 Editing PPP Options	435
28.8 Editing TCP/IP Options	435
28.9 Editing Login Script	437
28.10 Remote Node Filter	439
Chapter 29	
LAN Setup	441
29.1 Introduction to LAN Setup	441
29.2 Accessing the LAN Menus	441
29.3 LAN Port Filter Setup	441
29.4 TCP/IP and DHCP Ethernet Setup Menu	442
29.4.1 IP Alias Setup	444
29.5 Wireless LAN Setup	445
29.5.1 MAC Address Filter Setup	447
Chapter 30	
Internet Access	449
30.1 Introduction to Internet Access Setup	449
30.2 Ethernet Encapsulation	449
30.3 Configuring the PPTP Client	451
30.4 Configuring the PPPoE Client	451
30.5 Basic Setup Complete	452
Chapter 31	
DMZ Setup	453
31.1 Configuring DMZ Setup	453
31.2 DMZ Port Filter Setup	453
31.3 TCP/IP Setup	453
31.3.1 IP Address	454
31.3.2 IP Alias Setup	454
Chapter 32	
Route Setup	457
32.1 Configuring Route Setup	457
32.2 Route Assessment	457
32.3 Traffic Redirect	458
32.4 Route Failover	459
Chapter 33	
Remote Node Setup	461
33.1 Introduction to Remote Node Setup	461

33.2 Remote Node Setup	461
33.3 Remote Node Profile Setup	461
33.3.1 Ethernet Encapsulation	462
33.3.2 PPPoE Encapsulation	463
33.3.2.1 Outgoing Authentication Protocol	464
33.3.2.2 Nailed-Up Connection	464
33.3.2.3 Metric	464
33.3.3 PPTP Encapsulation	465
33.4 Edit IP	466
33.5 Remote Node Filter	468
Chapter 34	
IP Static Route Setup	471
34.1 IP Static Route Setup	471
Chapter 35	
Network Address Translation (NAT)	473
35.1 Using NAT	473
35.1.1 SUA (Single User Account) Versus NAT	473
35.1.2 Applying NAT	473
35.2 NAT Setup	475
35.2.1 Address Mapping Sets	476
35.2.1.1 SUA Address Mapping Set	476
35.2.1.2 User-Defined Address Mapping Sets	477
35.2.1.3 Ordering Your Rules	478
35.3 Configuring a Server behind NAT	480
35.4 General NAT Examples	483
35.4.1 Internet Access Only	483
35.4.2 Example 2: Internet Access with an Default Server	485
35.4.3 Example 3: Multiple Public IP Addresses With Inside Servers	485
35.4.4 Example 4: NAT Unfriendly Application Programs	489
35.5 Trigger Port Forwarding	491
35.5.1 Two Points To Remember About Trigger Ports	491
Chapter 36	
Introducing the ZyWALL Firewall	493
36.1 Using ZyWALL SMT Menus	493
36.1.1 Activating the Firewall	493
Chapter 37	
Filter Configuration	495
37.1 Introduction to Filters	495
37.1.1 The Filter Structure of the ZyWALL	496

37.2 Configuring a Filter Set	498
37.2.1 Configuring a Filter Rule	499
37.2.2 Configuring a TCP/IP Filter Rule	500
37.2.3 Configuring a Generic Filter Rule	502
37.3 Example Filter	504
37.4 Filter Types and NAT	506
37.5 Firewall Versus Filters	506
37.6 Applying a Filter	507
37.6.1 Applying LAN Filters	507
37.6.2 Applying DMZ Filters	507
37.6.3 Applying Remote Node Filters	508
Chapter 38	
SNMP Configuration	509
38.1 SNMP Configuration	509
38.2 SNMP Traps	510
Chapter 39	
System Information & Diagnosis	511
39.1 Introduction to System Status	511
39.2 System Status	511
39.3 System Information and Console Port Speed	513
39.3.1 System Information	513
39.3.2 Console Port Speed	514
39.4 Log and Trace	515
39.4.1 Viewing Error Log	515
39.4.2 Syslog Logging	516
39.4.3 Call-Triggering Packet	519
39.5 Diagnostic	519
39.5.1 WAN DHCP	520
Chapter 40	
Firmware and Configuration File Maintenance	523
40.1 Introduction	523
40.2 Filename Conventions	523
40.3 Backup Configuration	524
40.3.1 Backup Configuration	524
40.3.2 Using the FTP Command from the Command Line	525
40.3.3 Example of FTP Commands from the Command Line	526
40.3.4 GUI-based FTP Clients	526
40.3.5 File Maintenance Over WAN	526
40.3.6 Backup Configuration Using TFTP	527
40.3.7 TFTP Command Example	527

40.3.8 GUI-based TFTP Clients	528
40.3.9 Backup Via Console Port	528
40.4 Restore Configuration	529
40.4.1 Restore Using FTP	529
40.4.2 Restore Using FTP Session Example	531
40.4.3 Restore Via Console Port	531
40.5 Uploading Firmware and Configuration Files	532
40.5.1 Firmware File Upload	532
40.5.2 Configuration File Upload	533
40.5.3 FTP File Upload Command from the DOS Prompt Example	534
40.5.4 FTP Session Example of Firmware File Upload	534
40.5.5 TFTP File Upload	534
40.5.6 TFTP Upload Command Example	535
40.5.7 Uploading Via Console Port	535
40.5.8 Uploading Firmware File Via Console Port	535
40.5.9 Example Xmodem Firmware Upload Using HyperTerminal	536
40.5.10 Uploading Configuration File Via Console Port	536
40.5.11 Example Xmodem Configuration Upload Using HyperTerminal	537
Chapter 41	
System Maintenance Menus 8 to 10	539
41.1 Command Interpreter Mode	539
41.1.1 Command Syntax	539
41.1.2 Command Usage	540
41.2 Call Control Support	541
41.2.1 Budget Management	541
41.2.2 Call History	542
41.3 Time and Date Setting	543
41.3.1 Resetting the Time	546
Chapter 42	
Remote Management	547
42.1 Remote Management	547
42.1.1 Remote Management Limitations	549
Chapter 43	
IP Policy Routing	551
43.1 IP Routing Policy Summary	551
43.2 IP Routing Policy Setup	552
43.2.1 Applying Policy to Packets	554
43.3 IP Policy Routing Example	555

Chapter 44	
Call Scheduling	559
44.1 Introduction to Call Scheduling	559
Chapter 45	
Troubleshooting	563
45.1 Problems Starting Up the ZyWALL	563
45.2 Problems with the LAN Interface	563
45.3 Problems with the DMZ Interface	564
45.4 Problems with the WAN Interface	565
45.5 Problems Accessing the ZyWALL	565
45.5.1 Pop-up Windows, JavaScripts and Java Permissions	566
45.5.1.1 Internet Explorer Pop-up Blockers	566
45.5.1.2 JavaScripts	569
45.5.1.3 Java Permissions	571
Appendix A	
Product Specifications	575
Appendix B	
Removing and Installing a Fuse	581
Appendix C	
Setting up Your Computer's IP Address.....	583
Appendix D	
IP Subnetting	595
Appendix E	
PPPoE	603
Appendix F	
PPTP	605
Appendix G	
Wireless LANs	609
Appendix H	
Triangle Route	623
Appendix I	
SIP Passthrough	627
Appendix J	
VPN Setup.....	633
Appendix K	

Importing Certificates	645
Appendix L	
Command Interpreter.....	657
Appendix M	
Firewall Commands	659
Appendix N	
NetBIOS Filter Commands	665
Appendix O	
Certificates Commands	669
Appendix P	
Brute-Force Password Guessing Protection.....	673
Appendix Q	
Boot Commands	675
Appendix R	
Log Descriptions.....	677
Index.....	697

List of Figures

Figure 1 Secure Internet Access via Cable, DSL or Wireless Modem	56
Figure 2 VPN Application	57
Figure 3 ZyWALL Front Panel	57
Figure 4 Change Password Screen	60
Figure 5 Replace Certificate Screen	60
Figure 6 Example Xmodem Upload	61
Figure 7 Web Configurator HOME Screen in Router Mode	62
Figure 8 Web Configurator HOME Screen in Bridge Mode	65
Figure 9 Home : Show Statistics	70
Figure 10 Home : Show Statistics: Line Chart	71
Figure 11 Home : DHCP Table	72
Figure 12 Home : VPN Status	73
Figure 13 ISP Parameters : Ethernet Encapsulation	76
Figure 14 ISP Parameters : PPPoE Encapsulation	77
Figure 15 ISP Parameters: PPTP Encapsulation	79
Figure 16 Internet Access Wizard Setup Complete	81
Figure 17 VPN Wizard: Gateway Setting	82
Figure 18 VPN Wizard: Network Setting	83
Figure 19 VPN Wizard: IKE Tunnel Setting	85
Figure 20 VPN Wizard: IPSec Setting	87
Figure 21 VPN Wizard: VPN Status	89
Figure 22 VPN Wizard Setup Complete	91
Figure 23 LAN	96
Figure 24 Static DHCP	98
Figure 25 Physical Network & Partitioned Logical Networks	99
Figure 26 IP Alias	100
Figure 27 Bridge Loop: Bridge Connected to Wired LAN	103
Figure 28 Bridge	106
Figure 29 ZyWALL Wireless Security Levels	110
Figure 30 WPA-PSK Authentication	113
Figure 31 WPA with RADIUS Application Example	114
Figure 32 Wireless: No Security	115
Figure 33 Wireless: Static WEP	118
Figure 34 Wireless: WPA-PSK	119
Figure 35 Wireless: WPA	120
Figure 36 Wireless: 802.1x + Dynamic WEP	122
Figure 37 Wireless: 802.1x + Static WEP	123
Figure 38 Wireless: 802.1x + No WEP	125

Figure 39 Wireless: No Access 802.1x + Static WEP	126
Figure 40 MAC Address Filter	128
Figure 41 EAP Authentication	129
Figure 42 Least Load First Example	133
Figure 43 Weighted Round Robin Algorithm Example	134
Figure 44 Spillover Algorithm Example	135
Figure 45 WAN General	136
Figure 46 Load Balancing: Least Load First	139
Figure 47 Load Balancing: Weighted Round Robin	140
Figure 48 Load Balancing: Spillover	141
Figure 49 WAN: Ethernet Encapsulation	144
Figure 50 WAN: PPPoE Encapsulation	147
Figure 51 WAN: PPTP Encapsulation	150
Figure 52 Traffic Redirect WAN Setup	153
Figure 53 Traffic Redirect LAN Setup	153
Figure 54 Traffic Redirect	154
Figure 55 Dial Backup Setup	155
Figure 56 Advanced Setup	159
Figure 57 DMZ	162
Figure 58 DMZ: IP Alias	164
Figure 59 DMZ Public Address Example	165
Figure 60 DMZ Private and Public Address Example	166
Figure 61 ZyWALL Firewall Application	169
Figure 62 Three-Way Handshake	170
Figure 63 SYN Flood	171
Figure 64 Smurf Attack	172
Figure 65 Stateful Inspection	174
Figure 66 LAN to WAN Traffic	182
Figure 67 WAN to LAN Traffic	183
Figure 68 Default Rule (Router Mode)	184
Figure 69 Default Rule (Bridge Mode)	185
Figure 70 Rule Summary	186
Figure 71 Creating/Editing A Firewall Rule	188
Figure 72 Creating/Editing A Custom Service	190
Figure 73 Rule Summary	191
Figure 74 Rule Edit Example	192
Figure 75 Edit Custom Service Example	192
Figure 76 My Service Rule Configuration	193
Figure 77 My Service Example Rule Summary	194
Figure 78 Anti-Probing	197
Figure 79 Firewall Threshold	199
Figure 80 Content Filter : General	202
Figure 81 Content Filtering Lookup Procedure	204

Figure 82 Content Filter : Categories	205
Figure 83 Content Filter: Customization	212
Figure 84 Content Filter: Cache	215
Figure 85 myZyXEL.com Login Screen	218
Figure 86 myZyXEL.com Account Registration	219
Figure 87 Account Registration Successful	219
Figure 88 Account Confirmation E-Mail	220
Figure 89 myZyXEL.com Account Activation	220
Figure 90 Logged Into myZyXEL.com	221
Figure 91 Product Registration	221
Figure 92 Add New Product	222
Figure 93 Product Survey	222
Figure 94 Service Management	223
Figure 95 myZyXEL.com: My Product	223
Figure 96 myZyXEL.com: Service Management.	224
Figure 97 Service Registration	224
Figure 98 Service Registration: Successful	225
Figure 99 Service Management: Service Registered	225
Figure 100 Cerberian Login Screen	227
Figure 101 Content Filtering Reports Main Screen	227
Figure 102 Global Report Screen Example	228
Figure 103 Requested URLs Example	228
Figure 104 Encryption and Decryption	230
Figure 105 IPSec Architecture	231
Figure 106 Transport and Tunnel Mode IPSec Encapsulation	232
Figure 107 NAT Router Between IPSec Routers	238
Figure 108 Two Phases to Set Up the IPSec SA	240
Figure 109 Gateway and Network Policies	244
Figure 110 IPSec Fields Summary	244
Figure 111 VPN Rules (IKE)	245
Figure 112 VPN Rules (IKE): Gateway Policy: Edit	246
Figure 113 VPN Rules (IKE): Network Policy Edit	252
Figure 114 VPN Rules (IKE): Network Policy Move	256
Figure 115 VPN Rule (Manual)	257
Figure 116 VPN Rules (Manual): Edit	259
Figure 117 VPN: SA Monitor	262
Figure 118 VPN: Global Setting	263
Figure 119 Telecommuters Sharing One VPN Rule Example	264
Figure 120 Telecommuters Using Unique VPN Rules Example	265
Figure 121 Certificate Configuration Overview	268
Figure 122 My Certificates	269
Figure 123 My Certificate Import	271
Figure 124 My Certificate Create	272

Figure 125 My Certificate Details	275
Figure 126 Trusted CAs	278
Figure 127 Trusted CA Import	279
Figure 128 Trusted CA Details	281
Figure 129 Trusted Remote Hosts	284
Figure 130 Remote Host Certificates	285
Figure 131 Certificate Details	286
Figure 132 Trusted Remote Host Import	287
Figure 133 Trusted Remote Host Details	288
Figure 134 Directory Servers	290
Figure 135 Directory Server Add	291
Figure 136 Local User Database	294
Figure 137 RADIUS	295
Figure 138 How NAT Works	299
Figure 139 NAT Application With IP Alias	299
Figure 140 Port Restricted Cone NAT Example	300
Figure 141 NAT Overview	302
Figure 142 Address Mapping	304
Figure 143 Address Mapping Edit	305
Figure 144 Multiple Servers Behind NAT Example	308
Figure 145 Port Translation Example	309
Figure 146 Port Forwarding	310
Figure 147 Trigger Port Forwarding Process: Example	311
Figure 148 Port Triggering	312
Figure 149 Example of Static Routing Topology	315
Figure 150 IP Static Route	316
Figure 151 Edit IP Static Route	317
Figure 152 Policy Route Summary	320
Figure 153 Edit IP Policy Route	322
Figure 154 Subnet-based Bandwidth Management Example	326
Figure 155 Bandwidth Management: Summary	331
Figure 156 Bandwidth Management: Class Setup	333
Figure 157 Bandwidth Management: Edit Class	335
Figure 158 Bandwidth Management: Statistics	338
Figure 159 Bandwidth Management: Monitor	339
Figure 160 Private DNS Server Example	343
Figure 161 System DNS	343
Figure 162 System DNS: Add Address Record	345
Figure 163 System DNS: Insert Name Server Record	346
Figure 164 DNS Cache	347
Figure 165 DNS LAN	349
Figure 166 DDNS	351
Figure 167 HTTPS Implementation	355

Figure 168 WWW	356
Figure 169 Security Alert Dialog Box (Internet Explorer)	357
Figure 170 Security Certificate 1 (Netscape)	358
Figure 171 Security Certificate 2 (Netscape)	358
Figure 172 Login Screen (Internet Explorer)	360
Figure 173 Login Screen (Netscape)	360
Figure 174 Replace Certificate	361
Figure 175 Device-specific Certificate	361
Figure 176 Common ZyWALL Certificate	362
Figure 177 SSH Communication Example	362
Figure 178 How SSH Works	363
Figure 179 SSH	364
Figure 180 SSH Example 1: Store Host Key	365
Figure 181 SSH Example 2: Test	366
Figure 182 SSH Example 2: Log in	366
Figure 183 Secure FTP: Firmware Upload Example	367
Figure 184 Telnet Configuration on a TCP/IP Network	367
Figure 185 Telnet	368
Figure 186 FTP	369
Figure 187 SNMP Management Model	370
Figure 188 SNMP	372
Figure 189 DNS	373
Figure 190 CNM	374
Figure 191 Configuring UPnP	378
Figure 192 UPnP Ports	379
Figure 193 View Log	388
Figure 194 Log Settings	390
Figure 195 Reports	393
Figure 196 Web Site Hits Report Example	394
Figure 197 Protocol/Port Report Example	395
Figure 198 LAN IP Address Report Example	396
Figure 199 General Setup	398
Figure 200 Password Setup	399
Figure 201 Time and Date	400
Figure 202 Synchronization in Process	403
Figure 203 Synchronization is Successful	403
Figure 204 Synchronization Fail	403
Figure 205 Device Mode (Router Mode)	405
Figure 206 Device Mode (Bridge Mode)	406
Figure 207 Firmware Upload	408
Figure 208 Firmware Upload In Process	408
Figure 209 Network Temporarily Disconnected	409
Figure 210 Firmware Upload Error	409

Figure 211 Configuration	410
Figure 212 Configuration Upload Successful	411
Figure 213 Network Temporarily Disconnected	411
Figure 214 Configuration Upload Error	412
Figure 215 Reset Warning Message	412
Figure 216 Restart Screen	413
Figure 217 Initial Screen	416
Figure 218 Password Screen	416
Figure 219 Main Menu (Router Mode)	418
Figure 220 Main Menu (Bridge Mode)	418
Figure 221 Menu 23: System Password	422
Figure 222 Menu 1: General Setup (Router Mode)	423
Figure 223 Menu 1: General Setup (Bridge Mode)	424
Figure 224 Menu 1.1: Configure Dynamic DNS	425
Figure 225 Menu 1.1.1: DDNS Host Summary	426
Figure 226 Menu 1.1.1: DDNS Edit Host	427
Figure 227 MAC Address Cloning in WAN Setup	429
Figure 228 Menu 2: Dial Backup Setup	431
Figure 229 Menu 2.1: Advanced WAN Setup	432
Figure 230 Menu 11.3: Remote Node Profile (Backup ISP)	433
Figure 231 Menu 11.3.1: Remote Node PPP Options	435
Figure 232 Menu 11.3.2: Remote Node Network Layer Options	436
Figure 233 Menu 11.3.3: Remote Node Script	438
Figure 234 Menu 11.3.4: Remote Node Filter	439
Figure 235 Menu 3: LAN Setup	441
Figure 236 Menu 3.1: LAN Port Filter Setup	442
Figure 237 Menu 3: TCP/IP and DHCP Setup	442
Figure 238 Menu 3.2: TCP/IP and DHCP Ethernet Setup	443
Figure 239 Menu 3.2.1: IP Alias Setup	445
Figure 240 Menu 3.5: Wireless LAN Setup	446
Figure 241 Menu 3.5.1: WLAN MAC Address Filter	448
Figure 242 Menu 4: Internet Access Setup (Ethernet)	449
Figure 243 Internet Access Setup (PPTP)	451
Figure 244 Internet Access Setup (PPPoE)	452
Figure 245 Menu 5: DMZ Setup	453
Figure 246 Menu 5.1: DMZ Port Filter Setup	453
Figure 247 Menu 5: TCP/IP Setup	454
Figure 248 Menu 5.2: TCP/IP Setup	454
Figure 249 Menu 5.2.1: IP Alias Setup	455
Figure 250 Menu 6: Route Setup	457
Figure 251 Menu 6.1: Route Assessment	457
Figure 252 Menu 6.2: Traffic Redirect	458
Figure 253 Menu 6.3: Route Failover	459

Figure 254 Menu 11: Remote Node Setup	461
Figure 255 Menu 11.1: Remote Node Profile for Ethernet Encapsulation	462
Figure 256 Menu 11.1: Remote Node Profile for PPPoE Encapsulation	464
Figure 257 Menu 11.1: Remote Node Profile for PPTP Encapsulation	466
Figure 258 Menu 11.1.2: Remote Node Network Layer Options for Ethernet Encapsulation 467	
Figure 259 Menu 11.1.4: Remote Node Filter (Ethernet Encapsulation)	469
Figure 260 Menu 11.1.4: Remote Node Filter (PPPoE or PPTP Encapsulation)	469
Figure 261 Menu 12: IP Static Route Setup	471
Figure 262 Menu 12. 1: Edit IP Static Route	472
Figure 263 Menu 4: Applying NAT for Internet Access	474
Figure 264 Menu 11.1.2: Applying NAT to the Remote Node	474
Figure 265 Menu 15: NAT Setup	475
Figure 266 Menu 15.1: Address Mapping Sets	476
Figure 267 Menu 15.1.255: SUA Address Mapping Rules	476
Figure 268 Menu 15.1.1: First Set	478
Figure 269 Menu 15.1.1.1: Editing/Configuring an Individual Rule in a Set	479
Figure 270 Menu 15.2: NAT Server Sets	481
Figure 271 Menu 15.2.1: NAT Server Sets	481
Figure 272 15.2.1.2: NAT Server Configuration	482
Figure 273 Menu 15.2.1: NAT Server Setup	483
Figure 274 Server Behind NAT Example	483
Figure 275 NAT Example 1	484
Figure 276 Menu 4: Internet Access & NAT Example	484
Figure 277 NAT Example 2	485
Figure 278 Menu 15.2.1: Specifying an Inside Server	485
Figure 279 NAT Example 3	486
Figure 280 Example 3: Menu 11.1.2	487
Figure 281 Example 3: Menu 15.1.1.1	487
Figure 282 Example 3: Final Menu 15.1.1	488
Figure 283 Example 3: Menu 15.2.1	489
Figure 284 NAT Example 4	489
Figure 285 Example 4: Menu 15.1.1.1: Address Mapping Rule	490
Figure 286 Example 4: Menu 15.1.1: Address Mapping Rules	490
Figure 287 Menu 15.3.1: Trigger Port Setup	492
Figure 288 Menu 21: Filter and Firewall Setup	493
Figure 289 Menu 21.2: Firewall Setup	494
Figure 290 Outgoing Packet Filtering Process	495
Figure 291 Filter Rule Process	497
Figure 292 Menu 21: Filter and Firewall Setup	498
Figure 293 Menu 21.1: Filter Set Configuration	498
Figure 294 Menu 21.1.1.1: TCP/IP Filter Rule	500
Figure 295 Executing an IP Filter	502

Figure 296 Menu 21.1.1.1: Generic Filter Rule	503
Figure 297 Telnet Filter Example	504
Figure 298 Example Filter: Menu 21.1.3.1	505
Figure 299 Example Filter Rules Summary: Menu 21.1.3	505
Figure 300 Protocol and Device Filter Sets	506
Figure 301 Filtering LAN Traffic	507
Figure 302 Filtering DMZ Traffic	508
Figure 303 Filtering Remote Node Traffic	508
Figure 304 Menu 22: SNMP Configuration	509
Figure 305 Menu 24: System Maintenance	511
Figure 306 Menu 24.1: System Maintenance: Status	512
Figure 307 Menu 24.2: System Information and Console Port Speed	513
Figure 308 Menu 24.2.1: System Maintenance: Information	514
Figure 309 Menu 24.2.2: System Maintenance: Change Console Port Speed	515
Figure 310 Menu 24.3: System Maintenance: Log and Trace	515
Figure 311 Examples of Error and Information Messages	516
Figure 312 Menu 24.3.2: System Maintenance: Syslog Logging	516
Figure 313 Call-Triggering Packet Example	519
Figure 314 Menu 24.4: System Maintenance: Diagnostic	520
Figure 315 WAN & LAN DHCP	520
Figure 316 Telnet into Menu 24.5	525
Figure 317 FTP Session Example	526
Figure 318 System Maintenance: Backup Configuration	528
Figure 319 System Maintenance: Starting Xmodem Download Screen	528
Figure 320 Backup Configuration Example	529
Figure 321 Successful Backup Confirmation Screen	529
Figure 322 Telnet into Menu 24.6	530
Figure 323 Restore Using FTP Session Example	531
Figure 324 System Maintenance: Restore Configuration	531
Figure 325 System Maintenance: Starting Xmodem Download Screen	531
Figure 326 Restore Configuration Example	532
Figure 327 Successful Restoration Confirmation Screen	532
Figure 328 Telnet Into Menu 24.7.1: Upload System Firmware	533
Figure 329 Telnet Into Menu 24.7.2: System Maintenance	533
Figure 330 FTP Session Example of Firmware File Upload	534
Figure 331 Menu 24.7.1 As Seen Using the Console Port	536
Figure 332 Example Xmodem Upload	536
Figure 333 Menu 24.7.2 As Seen Using the Console Port	537
Figure 334 Example Xmodem Upload	537
Figure 335 Command Mode in Menu 24	539
Figure 336 Valid Commands	540
Figure 337 Call Control	541
Figure 338 Budget Management	542

Figure 339 Call History	543
Figure 340 Menu 24: System Maintenance	544
Figure 341 Menu 24.10 System Maintenance: Time and Date Setting	544
Figure 342 Menu 24.11 – Remote Management Control	548
Figure 343 Menu 25: Sample IP Routing Policy Summary	551
Figure 344 Menu 25.1: IP Routing Policy Setup	553
Figure 345 Menu 25.1.1: IP Routing Policy Setup	555
Figure 346 Example of IP Policy Routing	556
Figure 347 IP Routing Policy Example 1	556
Figure 348 IP Routing Policy Example 2	557
Figure 349 Schedule Setup	559
Figure 350 Schedule Set Setup	560
Figure 351 Applying Schedule Set(s) to a Remote Node (PPPoE)	561
Figure 352 Applying Schedule Set(s) to a Remote Node (PPTP)	562
Figure 353 Pop-up Blocker	567
Figure 354 Internet Options	567
Figure 355 Internet Options	568
Figure 356 Pop-up Blocker Settings	569
Figure 357 Internet Options	570
Figure 358 Security Settings - Java Scripting	571
Figure 359 Security Settings - Java	572
Figure 360 Java (Sun)	573
Figure 361 WLAN Card Installation	579
Figure 362 Console/Dial Backup Port Pin Layout	579
Figure 363 Ethernet Cable Pin Assignments	580
Figure 364 WIndows 95/98/Me: Network: Configuration	584
Figure 365 Windows 95/98/Me: TCP/IP Properties: IP Address	585
Figure 366 Windows 95/98/Me: TCP/IP Properties: DNS Configuration	586
Figure 367 Windows XP: Start Menu	587
Figure 368 Windows XP: Control Panel	587
Figure 369 Windows XP: Control Panel: Network Connections: Properties	588
Figure 370 Windows XP: Local Area Connection Properties	588
Figure 371 Windows XP: Internet Protocol (TCP/IP) Properties	589
Figure 372 Windows XP: Advanced TCP/IP Properties	590
Figure 373 Windows XP: Internet Protocol (TCP/IP) Properties	591
Figure 374 Macintosh OS 8/9: Apple Menu	592
Figure 375 Macintosh OS 8/9: TCP/IP	592
Figure 376 Macintosh OS X: Apple Menu	593
Figure 377 Macintosh OS X: Network	594
Figure 378 Single-Computer per Router Hardware Configuration	604
Figure 379 ZyWALL as a PPPoE Client	604
Figure 380 Transport PPP frames over Ethernet	605
Figure 381 PPTP Protocol Overview	606

Figure 382 Example Message Exchange between Computer and an ANT	607
Figure 383 Peer-to-Peer Communication in an Ad-hoc Network	609
Figure 384 Basic Service Set	610
Figure 385 Infrastructure WLAN	611
Figure 386 RTS/CTS	612
Figure 387 EAP Authentication	615
Figure 388 WEP Authentication Steps	618
Figure 389 Roaming Example	621
Figure 390 Ideal Setup	623
Figure 391 "Triangle Route" Problem	624
Figure 392 IP Alias	625
Figure 393 Gateways on the WAN Side	625
Figure 394 SIP User Agent Server	628
Figure 395 SIP Proxy Server	629
Figure 396 SIP Redirect Server	630
Figure 397 ZyWALL SIP ALG	631
Figure 398 VPN Rules	634
Figure 399 Headquarters Gateway Policy Edit	635
Figure 400 Branch Office Gateway Policy Edit	636
Figure 401 Headquarters VPN Rule	637
Figure 402 Branch Office VPN Rule	637
Figure 403 Headquarters Network Policy Edit	638
Figure 404 Branch Office Network Policy Edit	639
Figure 405 VPN Rule Configured	640
Figure 406 VPN Dial	640
Figure 407 VPN Tunnel Established	640
Figure 408 VPN Log Example	642
Figure 409 IKE/IPSec Debug Example	643
Figure 410 Security Certificate	645
Figure 411 Login Screen	646
Figure 412 Certificate General Information before Import	646
Figure 413 Certificate Import Wizard 1	647
Figure 414 Certificate Import Wizard 2	647
Figure 415 Certificate Import Wizard 3	648
Figure 416 Root Certificate Store	648
Figure 417 Certificate General Information after Import	649
Figure 418 ZyWALL Trusted CA Screen	650
Figure 419 CA Certificate Example	651
Figure 420 Personal Certificate Import Wizard 1	652
Figure 421 Personal Certificate Import Wizard 2	652
Figure 422 Personal Certificate Import Wizard 3	653
Figure 423 Personal Certificate Import Wizard 4	653
Figure 424 Personal Certificate Import Wizard 5	654

Figure 425 Personal Certificate Import Wizard 6	654
Figure 426 Access the ZyWALL Via HTTPS	654
Figure 427 SSL Client Authentication	655
Figure 428 ZyWALL Secure Login Screen	655
Figure 429 Option to Enter Debug Mode	675
Figure 430 Boot Module Commands	676
Figure 431 Displaying Log Categories Example	693
Figure 432 Displaying Log Parameters Example	694

List of Tables

Table 1 Front Panel LEDs	57
Table 2 Web Configurator HOME Screen in Router Mode	63
Table 3 Web Configurator HOME Screen in Bridge Mode	65
Table 4 Bridge and Router Mode Features Comparison	66
Table 5 Screens Summary	67
Table 6 Home: Show Statistics	70
Table 7 Home: Show Statistics: Line Chart	71
Table 8 Home: DHCP Table	72
Table 9 Home : VPN Status	73
Table 10 ISP Parameters : Ethernet Encapsulation	76
Table 11 ISP Parameters: PPPoE Encapsulation	78
Table 12 ISP Parameters : PPTP Encapsulation	79
Table 13 VPN Wizard: Gateway Setting	82
Table 14 VPN Wizard : Network Setting	83
Table 15 VPN Wizard: IKE Tunnel Setting	85
Table 16 VPN Wizard: IPSec Setting	87
Table 17 VPN Wizard: VPN Status	89
Table 18 LAN	96
Table 19 Static DHCP	98
Table 20 IP Alias	100
Table 21 STP Path Costs	104
Table 22 STP Port States	105
Table 23 Bridge	106
Table 24 Wireless Security Relational Matrix	110
Table 25 Wireless: No Security	116
Table 26 Wireless: Static WEP	118
Table 27 Wireless: WPA-PSK	119
Table 28 Wireless: WPA	121
Table 29 Wireless: 802.1x + Dynamic WEP	122
Table 30 Wireless: 802.1x + Static WEP	123
Table 31 Wireless: 802.1x + No WEP	125
Table 32 Wireless: No Access 802.1x + Static WEP	126
Table 33 MAC Address Filter	128
Table 34 Least Load First: Example 1	133
Table 35 Least Load First: Example 2	133
Table 36 WAN General	137
Table 37 Load Balancing: Least Load First	139
Table 38 Load Balancing: Weighted Round Robin	140

Table 39 Load Balancing: Spillover	141
Table 40 Private IP Address Ranges	141
Table 41 Example of Network Properties for LAN Servers with Fixed IP Addresses	142
Table 42 WAN: Ethernet Encapsulation	144
Table 43 WAN: PPPoE Encapsulation	148
Table 44 WAN: PPTP Encapsulation	151
Table 45 Traffic Redirect	154
Table 46 Dial Backup Setup	156
Table 47 Advanced Setup	159
Table 48 DMZ	162
Table 49 DMZ: IP Alias	164
Table 50 Common IP Ports	169
Table 51 ICMP Commands That Trigger Alerts	172
Table 52 Legal NetBIOS Commands	172
Table 53 Legal SMTP Commands	173
Table 54 Default Rule (Router Mode)	184
Table 55 Default Rule (Bridge Mode)	185
Table 56 Rule Summary	186
Table 57 Creating/Editing A Firewall Rule	189
Table 58 Creating/Editing A Custom Service	190
Table 59 Predefined Services	194
Table 60 Anti-Probing	197
Table 61 Firewall Threshold	199
Table 62 Content Filter : General	202
Table 63 Content Filter: Categories	205
Table 64 Content Filter: Customization	212
Table 65 Content Filter: Cache	215
Table 66 myZyXEL.com Numbers	218
Table 67 VPN and NAT	233
Table 68 ESP and AH	236
Table 69 Local ID Type and Content Fields	239
Table 70 Peer ID Type and Content Fields	239
Table 71 Matching ID Type and Content Configuration Example	239
Table 72 Mismatching ID Type and Content Configuration Example	240
Table 73 VPN screen Icons Key	243
Table 74 VPN Rules (IKE): Gateway Policy: Edit	247
Table 75 VPN Rules (IKE): Network Policy Edit	253
Table 76 VPN Rules (IKE): Network Policy Move	256
Table 77 VPN Rules (Manual)	257
Table 78 VPN Rules (Manual) Edit	259
Table 79 VPN: SA Monitor	262
Table 80 VPN: Global Setting	263
Table 81 Telecommuters Sharing One VPN Rule Example	264

Table 82 Telecommuters Using Unique VPN Rules Example	265
Table 83 My Certificates	269
Table 84 My Certificate Import	272
Table 85 My Certificate Create	273
Table 86 My Certificate Details	276
Table 87 Trusted CAs	278
Table 88 Trusted CA Import	280
Table 89 Trusted CA Details	281
Table 90 Trusted Remote Hosts	284
Table 91 Trusted Remote Host Import	287
Table 92 Trusted Remote Host Details	288
Table 93 Directory Servers	291
Table 94 Directory Server Add	292
Table 95 Local User Database	295
Table 96 RADIUS	296
Table 97 NAT Definitions	297
Table 98 NAT Mapping Types	301
Table 99 NAT Overview	302
Table 100 Address Mapping	304
Table 101 Address Mapping Edit	306
Table 102 Services and Port Numbers	307
Table 103 Port Forwarding	310
Table 104 Port Triggering	312
Table 105 IP Static Route	316
Table 106 Edit IP Static Route	317
Table 107 Policy Route Setup	320
Table 108 Edit IP Policy Route	322
Table 109 Application and Subnet-based Bandwidth Management Example	326
Table 110 Maximize Bandwidth Usage Example	328
Table 111 Priority-based Allotment of Unused and Unbudgeted Bandwidth Example	328
Table 112 Fairness-based Allotment of Unused and Unbudgeted Bandwidth Example	329
Table 113 Bandwidth Borrowing Example	330
Table 114 Bandwidth Management: Summary	331
Table 115 Bandwidth Management: Class Setup	333
Table 116 Bandwidth Management: Edit Class	335
Table 117 Services and Port Numbers	337
Table 118 Bandwidth Management: Statistics	338
Table 119 Bandwidth Management: Monitor	339
Table 120 System DNS	344
Table 121 System DNS: Add Address Record	345
Table 122 System DNS: Insert Name Server Record	346
Table 123 DNS Cache	348
Table 124 DNS LAN	349

Table 125 DDNS	351
Table 126 WWW	356
Table 127 SSH	364
Table 128 Telnet	368
Table 129 FTP	369
Table 130 SNMP Traps	371
Table 131 SNMP	372
Table 132 DNS	373
Table 133 CNM	374
Table 134 Configuring UPnP	378
Table 135 UPnP Ports	380
Table 136 View Log	388
Table 137 Example Log Description	389
Table 138 Log Settings	391
Table 139 Reports	393
Table 140 Web Site Hits Report	394
Table 141 Protocol/ Port Report	395
Table 142 LAN IP Address Report	396
Table 143 Report Specifications	396
Table 144 General Setup	398
Table 145 Password Setup	399
Table 146 Default Time Servers	399
Table 147 Time and Date	401
Table 148 MAC-address-to-port Mapping Table	404
Table 149 Device Mode (Router Mode)	405
Table 150 Device Mode (Bridge Mode)	406
Table 151 Firmware Upload	408
Table 152 Restore Configuration	410
Table 153 Main Menu Commands	416
Table 154 Main Menu Summary	418
Table 155 SMT Menus Overview	419
Table 156 Menu 1: General Setup (Router Mode)	423
Table 157 Menu 1: General Setup (Bridge Mode)	424
Table 158 Menu 1.1: Configure Dynamic DNS	425
Table 159 Menu 1.1.1: DDNS Host Summary	426
Table 160 Menu 1.1.1: DDNS Edit Host	427
Table 161 MAC Address Cloning in WAN Setup	430
Table 162 Menu 2: Dial Backup Setup	431
Table 163 Advanced WAN Port Setup: AT Commands Fields	432
Table 164 Advanced WAN Port Setup: Call Control Parameters	433
Table 165 Menu 11.3: Remote Node Profile (Backup ISP)	434
Table 166 Menu 11.3.1: Remote Node PPP Options	435
Table 167 Menu 11.3.2: Remote Node Network Layer Options	436

Table 168 Menu 11.3.3: Remote Node Script	439
Table 169 Menu 3.2: DHCP Ethernet Setup Fields	443
Table 170 Menu 3.2: LAN TCP/IP Setup Fields	443
Table 171 Menu 3.2.1: IP Alias Setup	445
Table 172 Menu 3.5: Wireless LAN Setup	446
Table 173 Menu 3.5.1: WLAN MAC Address Filter	448
Table 174 Menu 4: Internet Access Setup (Ethernet)	450
Table 175 New Fields in Menu 4 (PPTP) Screen	451
Table 176 New Fields in Menu 4 (PPPoE) screen	452
Table 177 Menu 6.1: Route Assessment	458
Table 178 Menu 6.2: Traffic Redirect	458
Table 179 Menu 6.3: Route Failover	459
Table 180 Menu 11.1: Remote Node Profile for Ethernet Encapsulation	462
Table 181 Fields in Menu 11.1 (PPPoE Encapsulation Specific)	465
Table 182 Menu 11.1: Remote Node Profile for PPTP Encapsulation	466
Table 183 Remote Node Network Layer Options Menu Fields	467
Table 184 Menu 12. 1: Edit IP Static Route	472
Table 185 Applying NAT in Menus 4 & 11.1.2	475
Table 186 SUA Address Mapping Rules	477
Table 187 Fields in Menu 15.1.1	478
Table 188 Menu 15.1.1.1: Editing/Configuring an Individual Rule in a Set	480
Table 189 15.2.1.2: NAT Server Configuration	482
Table 190 Menu 15.3: Trigger Port Setup	492
Table 191 Abbreviations Used in the Filter Rules Summary Menu	499
Table 192 Rule Abbreviations Used	499
Table 193 Menu 21.1.1.1: TCP/IP Filter Rule	500
Table 194 Generic Filter Rule Menu Fields	503
Table 195 SNMP Configuration Menu Fields	509
Table 196 SNMP Traps	510
Table 197 System Maintenance: Status Menu Fields	512
Table 198 Fields in System Maintenance: Information	514
Table 199 System Maintenance Menu Syslog Parameters	516
Table 200 System Maintenance Menu Diagnostic	521
Table 201 Filename Conventions	524
Table 202 General Commands for GUI-based FTP Clients	526
Table 203 General Commands for GUI-based TFTP Clients	528
Table 204 Valid Commands	540
Table 205 Budget Management	542
Table 206 Call History	543
Table 207 Menu 24.10 System Maintenance: Time and Date Setting	545
Table 208 Menu 24.11 – Remote Management Control	548
Table 209 Menu 25: Sample IP Routing Policy Summary	551
Table 210 IP Routing Policy Setup	552

Table 211 Menu 25.1: IP Routing Policy Setup	553
Table 212 Menu 25.1.1: IP Routing Policy Setup	555
Table 213 Schedule Set Setup	560
Table 214 Troubleshooting the Start-Up of Your ZyWALL	563
Table 215 Troubleshooting the LAN Interface	563
Table 216 Troubleshooting the DMZ Interface	564
Table 217 Troubleshooting the WAN Interface	565
Table 218 Troubleshooting Accessing the ZyWALL	565
Table 219 Device Specifications	575
Table 220 Performance	575
Table 221 Firmware Features	576
Table 222 Feature Specifications	577
Table 223 Compatible ZyXEL WLAN Cards and Security Features	578
Table 224 Console/Dial Backup Port Pin Assignments	580
Table 225 Classes of IP Addresses	595
Table 226 Allowed IP Address Range By Class	596
Table 227 "Natural" Masks	596
Table 228 Alternative Subnet Mask Notation	597
Table 229 Two Subnets Example	597
Table 230 Subnet 1	598
Table 231 Subnet 2	598
Table 232 Subnet 1	599
Table 233 Subnet 2	599
Table 234 Subnet 3	599
Table 235 Subnet 4	600
Table 236 Eight Subnets	600
Table 237 Class C Subnet Planning	600
Table 238 Class B Subnet Planning	601
Table 239 IEEE802.11g	613
Table 240 Comparison of EAP Authentication Types	619
Table 241 Wireless Security Relational Matrix	620
Table 242 SIP Call Progression	627
Table 243 Firewall Commands	659
Table 244 NetBIOS Filter Default Settings	666
Table 245 Certificates Commands	669
Table 246 Brute-Force Password Guessing Protection Commands	673
Table 247 System Maintenance Logs	677
Table 248 System Error Logs	678
Table 249 Access Control Logs	679
Table 250 TCP Reset Logs	679
Table 251 Packet Filter Logs	680
Table 252 ICMP Logs	680
Table 253 CDR Logs	681

Table 254 PPP Logs	681
Table 255 UPnP Logs	681
Table 256 Content Filtering Logs	681
Table 257 Attack Logs	682
Table 258 Remote Management Logs	683
Table 259 Wireless Logs	684
Table 260 IPSec Logs	684
Table 261 IKE Logs	685
Table 262 PKI Logs	688
Table 263 Certificate Path Verification Failure Reason Codes	689
Table 264 802.1X Logs	690
Table 265 ACL Setting Notes	691
Table 266 ICMP Notes	691
Table 267 Syslog Logs	692
Table 268 RFC-2408 ISAKMP Payload Types	693

Preface

Congratulations on your purchase of the ZyWALL 70.

Note: Register your product online to receive e-mail notices of firmware upgrades and information at www.zyxel.com for global products, or at www.us.zyxel.com for North American products.

Your ZyWALL is easy to install and configure.

About This User's Guide

This manual is designed to guide you through the configuration of your ZyWALL for its various applications. The web configurator parts of this guide contain background information on features configurable by web configurator. The SMT parts of this guide contain background information solely on features not configurable by web configurator.

Note: Use the web configurator, System Management Terminal (SMT) or command interpreter interface to configure your ZyWALL. Not all features can be configured through all interfaces.

Related Documentation

- Supporting Disk

Refer to the included CD for support documents.

- Quick Start Guide

The Quick Start Guide is designed to help you get up and running right away. It contains a detailed easy-to-follow connection diagram, default settings, handy checklists and information on setting up your network and configuring for Internet access.

- Web Configurator Online Help

Embedded web help for descriptions of individual screens and supplementary information.

- ZyXEL Glossary and Web Site

Please refer to www.zyxel.com for an online glossary of networking terms and additional support documentation.











User Guide Feedback

Help us help you! E-mail all User Guide-related comments, questions or suggestions for improvement to techwriters@zyxel.com.tw or send regular mail to The Technical Writing Team, ZyXEL Communications Corp., 6 Innovation Road II, Science-Based Industrial Park, Hsinchu, 300, Taiwan. Thank you!

Syntax Conventions

- “Enter” means for you to type one or more characters. “Select” or “Choose” means for you to use one predefined choices.
- The SMT menu titles and labels are in **Bold Times New Roman** font. Predefined field choices are in **Bold Arial** font. Command and arrow keys are enclosed in square brackets. [ENTER] means the Enter, or carriage return key; [ESC] means the Escape key and [SPACE BAR] means the Space Bar.
- Mouse action sequences are denoted using a comma. For example, “click the Apple icon, **Control Panels** and then **Modem**” means first click the Apple icon, then point your mouse pointer to **Control Panels** and then click **Modem**.
- For brevity's sake, we will use “e.g.,” as a shorthand for “for instance”, and “i.e.,” for “that is” or “in other words” throughout this manual.

Graphics Icons Key

ZyWALL 	Computer 	Notebook computer 
Server 	DSLAM 	Firewall 
Telephone 	Switch 	Router 
Wireless Signal 		

CHAPTER 1

Getting to Know Your ZyWALL

This chapter introduces the main features and applications of the ZyWALL.

1.1 ZyWALL 70 Internet Security Appliance Overview

The ZyWALL 70 Internet security gateway is designed for medium sized business that need the increased throughput and reliability of dual WAN ports and load balancing. The ZyWALL is loaded with security features including VPN, firewall, content filtering, and certificates. The ZyWALL's De-Militarized Zone (DMZ) increases LAN security by providing separate ports for connecting publicly accessible servers.

You can also deploy the ZyWALL as a transparent firewall in an existing network with minimal configuration.

The ZyWALL provides bandwidth management, NAT, port forwarding, policy routing, DHCP server and many other powerful features.

The PCMCIA/CardBus slot allows you to add a 802.11b/g-compliant wireless LAN. The ZyWALL offers highly secured wireless connectivity to your wired network with IEEE 802.1x, WEP data encryption, WPA (Wi-Fi Protected Access) and MAC address filtering.

1.2 Physical Features

LAN Port

The 10/100 Mbps auto-negotiating Ethernet LAN port allows the ZyWALL to detect the speed of incoming transmissions and adjust appropriately without manual intervention. It allows data transfer of either 10 Mbps or 100 Mbps in either half-duplex or full-duplex mode depending on your Ethernet network. The port is also auto-crossover (MDI/MDI-X) meaning it automatically adjusts to either a crossover or straight-through Ethernet cable.

DMZ Ports

Public servers (Web, FTP, etc.) attached to a DeMilitarized Zone (DMZ) port are visible to the outside world (while still being protected from DoS (Denial of Service) attacks such as SYN flooding and Ping of Death) and can also be accessed from the secure LAN.

The 10/100 Mbps auto-negotiating Ethernet ports allow the ZyWALL to detect the speed of incoming transmissions and adjust appropriately without manual intervention. It allows data transfer of either 10 Mbps or 100 Mbps in either half-duplex or full-duplex mode depending on your Ethernet network. The ports are also auto-crossover (MDI/MDI-X) meaning they automatically adjust to either a crossover or straight-through Ethernet cable.

Dual Auto-negotiating 10/100 Mbps Ethernet WAN

The Ethernet WAN ports attach to the Internet via broadband modem or router. You can use a second connection for load sharing to increase overall network throughput or as a backup to enhance network reliability.

The 10/100 Mbps auto-negotiating Ethernet ports allow the ZyWALL to detect the speed of incoming transmissions and adjust appropriately without manual intervention. They allow data transfers of either 10 Mbps or 100 Mbps in either half-duplex or full-duplex mode depending on your Ethernet network. The ports are also auto-crossover (MDI/MDI-X) meaning they automatically adjust to either a crossover or straight-through Ethernet cable.

Dial Backup WAN

The dial backup port can be used in reserve as a traditional dial-up connection when/if ever the WAN 1, 2 and traffic redirect connections fail.

Time and Date

The ZyWALL allows you to get the current time and date from an external server when you turn on your ZyWALL. You can also set the time manually. The Real Time Chip (RTC) keeps track of the time and date.

Reset Button

Use the reset button to restore the factory default password to 1234; IP address to 192.168.1.1, subnet mask to 255.255.255.0 and DHCP server enabled with a pool of 32 IP addresses starting at 192.168.1.33.

Dual PCMCIA and CardBus Slot

The dual PCMCIA and CardBus slot provides the option of a wireless LAN.

IEEE 802.11 b/g Wireless LAN

The optional wireless LAN card provides mobility and a fast network environment for small and home offices. Users can connect to the local area network without any wiring efforts and enjoy reliable high-speed connectivity.

1.2.1 Non-Physical Features

Load Balancing

The ZyWALL improves quality of service and maximizes bandwidth utilization by dividing traffic loads between the two WAN interfaces (or ports).

Transparent Firewall

Transparent firewall is also known as a bridge firewall. The ZyWALL can act as a bridge and still have the capability of filtering and inspecting the packets between a router and the LAN, or two routers. You do not need to do any other changes to your existing network.

SIP Passthrough

The ZyWALL includes a SIP Application Layer Gateway (ALG). It allows VoIP calls to pass through NAT by examining and translating IP addresses embedded in the data stream.

STP (Spanning Tree Protocol) / RSTP (Rapid STP)

When the ZyWALL is set to bridge mode, (R)STP detects and breaks network loops and provides backup links between switches, bridges or routers. It allows a bridge to interact with other (R)STP -compliant bridges in your network to ensure that only one path exists between any two stations on the network.

Bandwidth Management

Bandwidth management allows you to allocate network resources according to defined policies. This policy-based bandwidth allocation helps your network to better handle real-time applications such as Voice-over-IP (VoIP).

IPSec VPN Capability

Establish a Virtual Private Network (VPN) to connect with business partners and branch offices using data encryption and the Internet to provide secure communications without the expense of leased site-to-site lines. The ZyWALL VPN is based on the IPSec standard and is fully interoperable with other IPSec-based VPN products.

X-Auth (Extended Authentication)

X-Auth provides added security for VPN by requiring each VPN client to use a username and password.

Certificates

The ZyWALL can use certificates (also called digital IDs) to authenticate users. Certificates are based on public-private key pairs. Certificates provide a way to exchange public keys for use in authentication.

SSH

The ZyWALL uses the SSH (Secure Shell) secure communication protocol to provide secure encrypted communication between two hosts over an unsecured network.

HTTPS

HyperText Transfer Protocol over Secure Socket Layer, or HTTP over SSL is a web protocol that encrypts and decrypts web sessions. Use HTTPS for secure web configurator access to the ZyWALL

Firewall

The ZyWALL is a stateful inspection firewall with DoS (Denial of Service) protection. By default, when the firewall is activated, all incoming traffic from the WAN to the LAN is blocked unless it is initiated from the LAN. The ZyWALL firewall supports TCP/UDP inspection, DoS detection and prevention, real time alerts, reports and logs.

Content Filtering

The ZyWALL can block web features such as ActiveX controls, Java applets and cookies, as well as disable web proxies. The ZyWALL can block or allow access to web sites that you specify. The ZyWALL can also block access to web sites containing keywords that you specify. You can define time periods and days during which content filtering is enabled and include or exclude a range of users on the LAN from content filtering.

You can also subscribe to category-based content filtering that allows your ZyWALL to check web sites against an external database of dynamically updated ratings of millions of web sites.

Universal Plug and Play (UPnP)

Using the standard TCP/IP protocol, the ZyWALL and other UPnP-enabled devices can dynamically join a network, obtain an IP address and convey its capabilities to other devices on the network.

RADIUS (RFC2138, 2139)

RADIUS (Remote Authentication Dial In User Service) server enables authentication, authorization and accounting for users.

IEEE 802.1x for Network Security

The ZyWALL supports the IEEE 802.1x standard that works with the IEEE 802.11 to enhance user authentication. With the local user profile, the ZyWALL allows you to configure up to 32 user profiles without a network authentication server. In addition, centralized user and accounting management is possible on an optional network authentication server.

Wi-Fi Protected Access

Wi-Fi Protected Access (WPA) is a subset of the IEEE 802.11i security specification draft. Key differences between WPA and WEP are user authentication and improved data encryption.

Wireless LAN MAC Address Filtering

Your ZyWALL can check the MAC addresses of wireless stations against a list of allowed or denied MAC addresses.

WEP Encryption

WEP (Wired Equivalent Privacy) encrypts data frames before transmitting over the wireless network to help keep network communications private.

Packet Filtering

The packet filtering mechanism blocks unwanted traffic from entering/leaving your network.

Call Scheduling

Configure call time periods to restrict and allow access for users on remote nodes.

PPPoE

PPPoE facilitates the interaction of a host with an Internet modem to achieve access to high-speed data networks via a familiar "dial-up networking" user interface.

PPTP Encapsulation

Point-to-Point Tunneling Protocol (PPTP) is a network protocol that enables secure transfer of data from a remote client to a private server, creating a Virtual Private Network (VPN) using a TCP/IP-based network.

PPTP supports on-demand, multi-protocol and virtual private networking over public networks, such as the Internet. The ZyWALL supports one PPTP server connection at any given time.

Dynamic DNS Support

With Dynamic DNS (Domain Name System) support, you can have a static hostname alias for a dynamic IP address, allowing the host to be more easily accessible from various locations on the Internet. You must register for this service with a Dynamic DNS service provider.

IP Multicast

Deliver IP packets to a specific group of hosts using IP multicast. IGMP (Internet Group Management Protocol) is the protocol used to support multicast groups. The latest version is version 2 (see RFC 2236); the ZyWALL supports both versions 1 and 2.

IP Alias

IP Alias allows you to partition a physical network into logical networks over the same Ethernet interface. The ZyWALL supports three logical LAN and/or DMZ interfaces via its single physical Ethernet LAN and/or DMZ interface with the ZyWALL itself as the gateway for each network.

IP Policy Routing

IP Policy Routing provides a mechanism to override the default routing behavior and alter packet forwarding based on the policies defined by the network administrator.

Central Network Management

Central Network Management (CNM) allows an enterprise or service provider network administrator to manage your ZyWALL. The enterprise or service provider network administrator can configure your ZyWALL, perform firmware upgrades and do troubleshooting for you.

SNMP

SNMP (Simple Network Management Protocol) is a protocol used for exchanging management information between network devices. SNMP is a member of the TCP/IP protocol suite. Your ZyWALL supports SNMP agent functionality, which allows a manager station to manage and monitor the ZyWALL through the network. The ZyWALL supports SNMP version one (SNMPv1).

Network Address Translation (NAT)

Network Address Translation (NAT) allows the translation of an Internet protocol address used within one network (for example a private IP address used in a local network) to a different IP address known within another network (for example a public IP address used on the Internet).

Traffic Redirect

Traffic Redirect forwards WAN traffic to a backup gateway on the LAN when the ZyWALL cannot connect to the Internet, thus acting as an auxiliary backup when your regular WAN connection fails.

Port Forwarding

Use this feature to forward incoming service requests to a server on your local network. You may enter a single port number or a range of port numbers to be forwarded, and the local IP address of the desired server.

DHCP (Dynamic Host Configuration Protocol)

DHCP (Dynamic Host Configuration Protocol) allows the individual client computers to obtain the TCP/IP configuration at start-up from a centralized DHCP server. The ZyWALL has built-in DHCP server capability, enabled by default, which means it can assign IP addresses, an IP default gateway and DNS servers to all systems that support the DHCP client. The ZyWALL can also act as a surrogate DHCP server (**DHCP Relay**) where it relays IP address assignment from the actual real DHCP server to the clients.

Full Network Management

The embedded web configurator is an all-platform web-based utility that allows you to easily access the ZyWALL's management settings and configure the firewall. Most functions of the ZyWALL are also software configurable via the SMT (System Management Terminal) interface. The SMT is a menu-driven interface that you can access from a terminal emulator through the console port or over a telnet connection.

RoadRunner Support

In addition to standard cable modem services, the ZyWALL supports Time Warner's RoadRunner Service.

Logging and Tracing

Built-in message logging and packet tracing.

Syslog facility support.

Upgrade ZyWALL Firmware via LAN

The firmware of the ZyWALL can be upgraded via the LAN.

Embedded FTP and TFTP Servers

The ZyWALL's embedded FTP and TFTP Servers enable fast firmware upgrades as well as configuration file backups and restoration.

1.3 Applications for the ZyWALL

Here are some examples of what you can do with your ZyWALL.

1.3.1 Secure Broadband Internet Access via Cable or DSL Modem

You can connect a cable modem, DSL or wireless modem to the ZyWALL for broadband Internet access via Ethernet or wireless port on the modem. The ZyWALL guarantees not only high speed Internet access, but secure internal network protection and traffic management as well.

Figure 1 Secure Internet Access via Cable, DSL or Wireless Modem

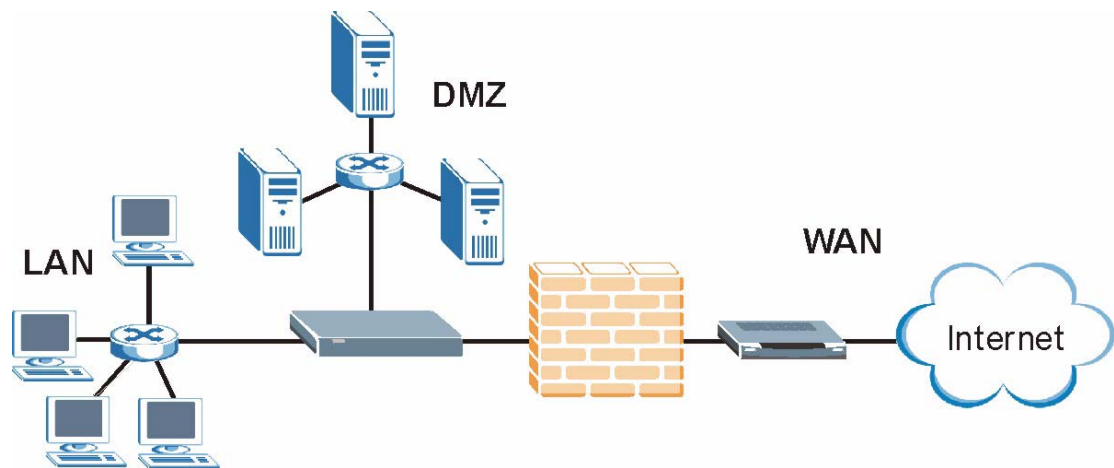

1.3.2 VPN Application

ZyWALL VPN is an ideal cost-effective way to connect branch offices and business partners over the Internet without the need (and expense) for leased lines between sites.

Figure 2 VPN Application

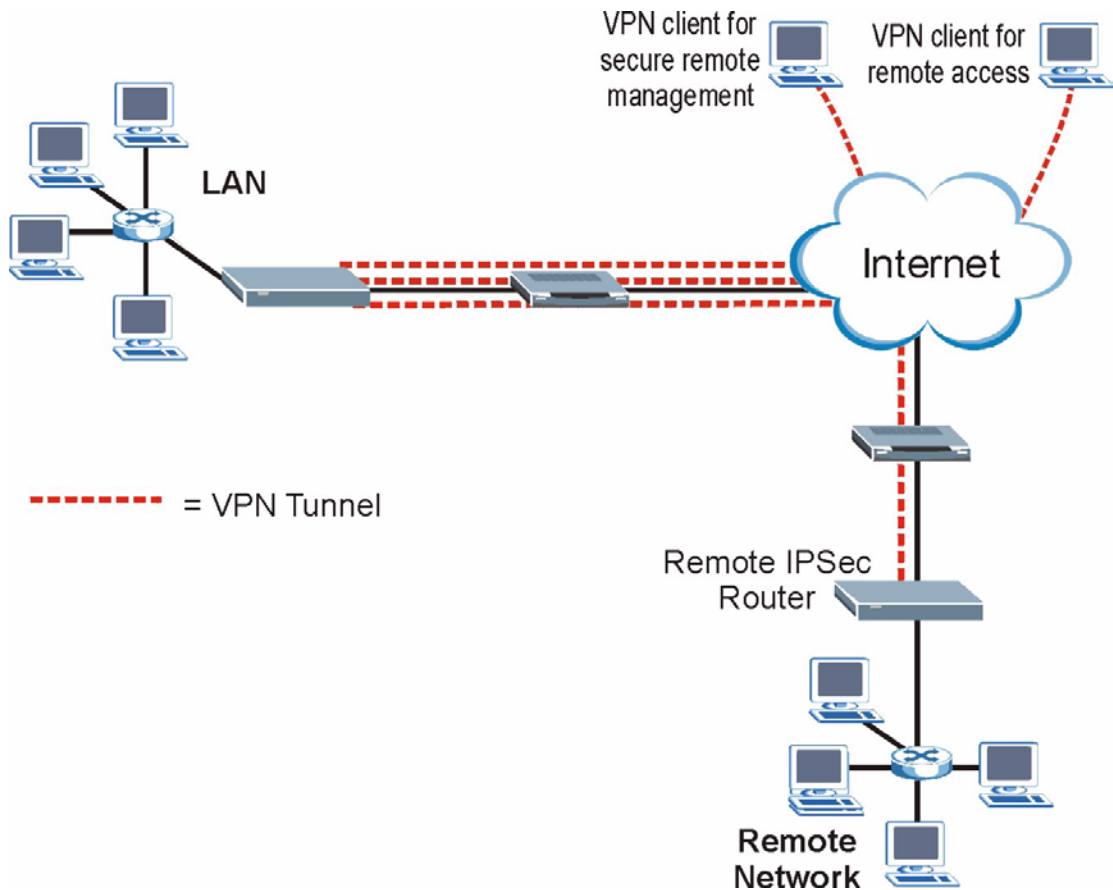

1.3.3 Front Panel LEDs

Figure 3 ZyWALL Front Panel

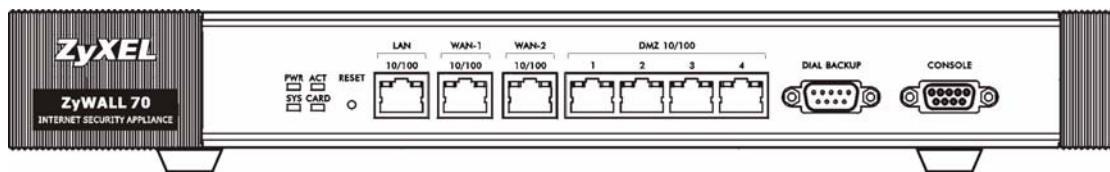

The following table describes the LEDs.

Table 1 Front Panel LEDs

LED	COLOR	STATUS	DESCRIPTION
PWR		Off	The ZyWALL is turned off.
	Green	On	The ZyWALL is turned on.
	Red	On	The power to the ZyWALL is too low.

Table 1 Front Panel LEDs (continued)

LED	COLOR	STATUS	DESCRIPTION
SYS	Green	Off	The ZyWALL is not ready or has failed.
		On	The ZyWALL is ready and running.
		Flashing	The ZyWALL is restarting.
ACT	Green	Off	The backup port is not connected.
		Flashing	The backup port is sending or receiving packets.
CARD	Green	Off	The wireless LAN is not ready, or has failed.
		On	The wireless LAN is ready.
		Flashing	The wireless LAN is sending or receiving packets.
LAN 10/100		Off	The LAN/DMZ is not connected.
		Green	On
	Orange	On	The ZyWALL has a successful 100Mbps Ethernet connection.
		Flashing	The 100M LAN is sending or receiving packets.
WAN1/2 10/100		Off	The WAN connection is not ready, or has failed.
		Green	On
	Orange	On	The ZyWALL has a successful 100Mbps WAN connection.
		Flashing	The 100M WAN is sending or receiving packets.
DMZ 10/100		Off	The LAN/DMZ is not connected.
		Green	On
	Orange	On	The ZyWALL has a successful 100Mbps Ethernet connection.
		Flashing	The 100M LAN is sending or receiving packets.

CHAPTER 2

Introducing the Web Configurator

This chapter describes how to access the ZyWALL web configurator and provides an overview of its screens.

2.1 Web Configurator Overview

The web configurator is an HTML-based management interface that allows easy ZyWALL setup and management via Internet browser. Use Internet Explorer 6.0 and later or Netscape Navigator 7.0 and later versions. The recommended screen resolution is 1024 by 768 pixels.

In order to use the web configurator you need to allow:

- Web browser pop-up windows from your device. Web pop-up blocking is enabled by default in Windows XP SP (Service Pack) 2.
- JavaScripts (enabled by default).
- Java permissions (enabled by default).

See the **Troubleshooting** chapter if you want to make sure these functions are allowed in Internet Explorer.

2.2 Accessing the ZyWALL Web Configurator

- 1 Make sure your ZyWALL hardware is properly connected and prepare your computer/ computer network to connect to the ZyWALL (refer to the *Quick Start Guide*).
- 2 Launch your web browser.
- 3 Type "192.168.1.1" as the URL.
- 4 Type "1234" (default) as the password and click **Login**. In some versions, the default password appears automatically - if this is the case, click **Login**.
- 5 You should see a screen asking you to change your password (highly recommended) as shown next. Type a new password (and retype it to confirm) and click **Apply** or click **Ignore**.

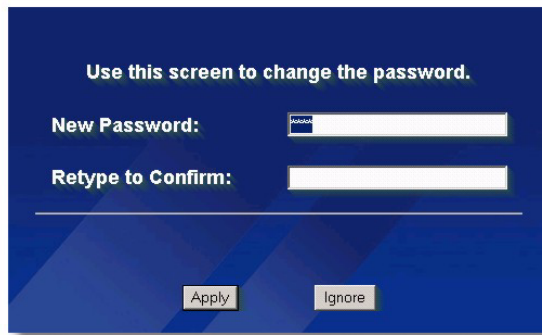
Figure 4 Change Password Screen

Use this screen to change the password.

New Password:

Retype to Confirm:

- 6 Click **Apply** in the **Replace Certificate** screen to create a certificate using your ZyWALL's MAC address that will be specific to this device.

Note: If you do not replace the default certificate here or in the **CERTIFICATES** screen, this screen displays every time you access the web configurator.

Figure 5 Replace Certificate Screen

Replace Factory Default Certificate

The factory default certificate is common to all ZyWALL models. Click Apply to create a certificate using your ZyWALL's MAC address that will be specific to this device.

- 7 You should now see the **HOME** screen (see [Figure 7 on page 62](#)).

Note: The management session automatically times out when the time period set in the **Administrator Inactivity Timer** field expires (default five minutes). Simply log back into the ZyWALL if this happens to you.

2.3 Resetting the ZyWALL

If you forget your password or cannot access the web configurator, you will need to reload the factory-default configuration file or use the **RESET** button on the back of the ZyWALL. Uploading this configuration file replaces the current configuration file with the factory-default configuration file. This means that you will lose all configurations that you had previously and the speed of the console port will be reset to the default of 9600bps with 8 data bit, no parity, one stop bit and flow control set to none. The password will be reset to 1234, also.

2.3.1 Procedure To Use The Reset Button

Make sure the **SYS LED** is on (not blinking) before you begin this procedure.

- 1 Press the **RESET** button for ten seconds, and then release it. If the **SYS LED** begins to blink, the defaults have been restored and the ZyWALL restarts. Otherwise, go to step 2.
- 2 Turn the ZyWALL off.
- 3 While pressing the **RESET** button, turn the ZyWALL on.
- 4 Continue to hold the **RESET** button. The **SYS LED** will begin to blink and flicker very quickly after about 20 seconds. This indicates that the defaults have been restored and the ZyWALL is now restarting.
- 5 Release the **RESET** button and wait for the ZyWALL to finish restarting.

2.3.2 Uploading a Configuration File Via Console Port

- 1 Download the default configuration file from the ZyXEL FTP site, unzip it and save it in a folder.
- 2 Turn off the ZyWALL, begin a terminal emulation software session and turn on the ZyWALL again. When you see the message "Press Any key to enter Debug Mode within 3 seconds", press any key to enter debug mode.
- 3 Enter "y" at the prompt below to go into debug mode.
- 4 Enter "atlc" after "Enter Debug Mode" message.
- 5 Wait for "Starting XMODEM upload" message before activating Xmodem upload on your terminal. This is an example Xmodem configuration upload using HyperTerminal.

Figure 6 Example Xmodem Upload

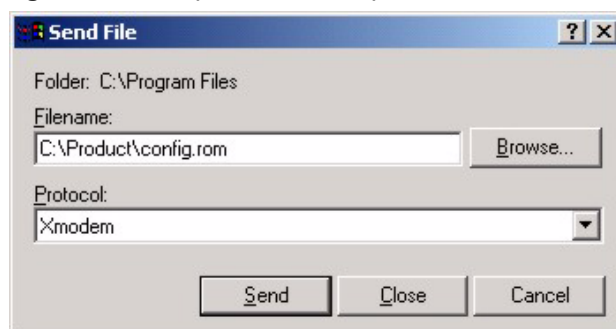

Type the configuration file's location, or click **Browse** to search for it.
Choose the **Xmodem** protocol.
Then click **Send**.

- 6 After successful firmware upload, enter "atgo" to restart the router.

2.4 Navigating the ZyWALL Web Configurator

The following summarizes how to navigate the web configurator from the **HOME** screen.

Note: Follow the instructions you see in the **HOME** screen or click the  icon (lo

The screen varies according to the device mode you select in the **MAINTENANCE Device Mode** screen.

2.4.1 Router Mode

The following screen displays when the ZyWALL is set to router mode. The ZyWALL is set to router mode by default.

Figure 7 Web Configurator HOME Screen in Router Mode

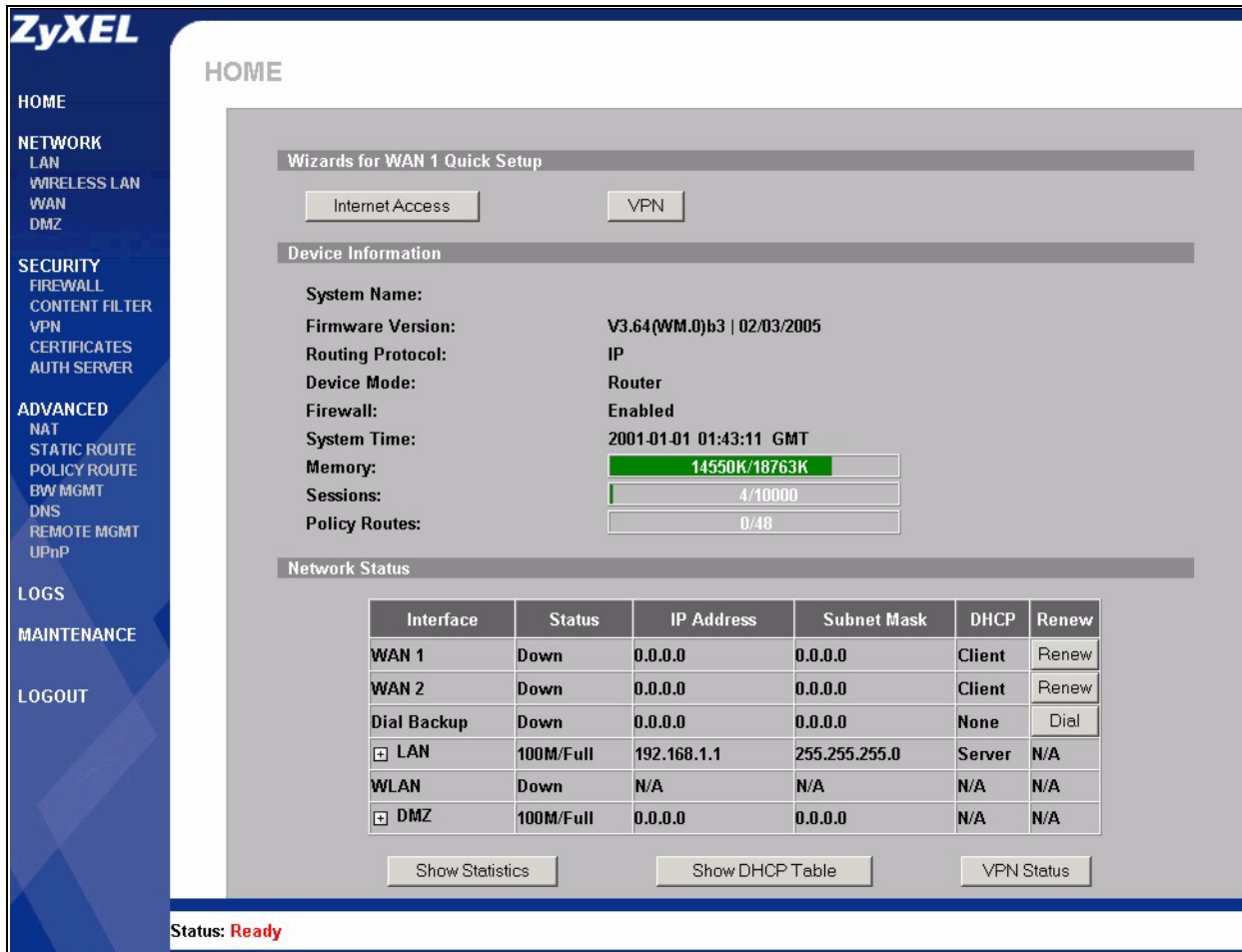

ZyXEL

HOME

HOME
NETWORK
LAN
WIRELESS LAN
WAN
DMZ
SECURITY
FIREWALL
CONTENT FILTER
VPN
CERTIFICATES
AUTH SERVER
ADVANCED
NAT
STATIC ROUTE
POLICY ROUTE
BW MGMT
DNS
REMOTE MGMT
UPnP
LOGS
MAINTENANCE
LOGOUT

HOME

Wizards for WAN 1 Quick Setup

Internet Access VPN

Device Information

System Name:
Firmware Version: V3.64(WM.0)b3 | 02/03/2005
Routing Protocol: IP
Device Mode: Router
Firewall: Enabled
System Time: 2001-01-01 01:43:11 GMT
Memory: 14550K/18763K
Sessions: 4/10000
Policy Routes: 0/48

Network Status

Interface	Status	IP Address	Subnet Mask	DHCP	Renew
WAN 1	Down	0.0.0.0	0.0.0.0	Client	Renew
WAN 2	Down	0.0.0.0	0.0.0.0	Client	Renew
Dial Backup	Down	0.0.0.0	0.0.0.0	None	Dial
<input type="checkbox"/> LAN	100M/Full	192.168.1.1	255.255.255.0	Server	N/A
WLAN	Down	N/A	N/A	N/A	N/A
<input type="checkbox"/> DMZ	100M/Full	0.0.0.0	0.0.0.0	N/A	N/A

Show Statistics Show DHCP Table VPN Status

Status: Ready

Use submenus to configure ZyWALL features.

Click **LOGOUT** at any time to exit the web configurator.

Click **MAINTENANCE** to view information about your ZyWALL or upgrade configuration/firmware files. Maintenance includes **General**, **Password**, **Time and Date**, **Device Mode**, **F/W** (firmware) **Upload**, **Configuration** (Backup, Restore, Default), and **Restart**.

The following table describes the labels in this screen.

Table 2 Web Configurator HOME Screen in Router Mode

LABEL	DESCRIPTION
Wizards for WAN1 Quick Setup	
Internet Access	Click Internet Access to use the initial configuration wizard. This configures WAN1.
VPN Wizard	Click VPN Wizard to create VPN policies.
Device Information	
System Name	This is the System Name you enter in the MAINTENANCE General screen. It is for identification purposes.
Firmware Version	This is the ZyNOS Firmware version and the date created. ZyNOS is ZyXEL's proprietary Network Operating System design.
Routing Protocol	This shows the routing protocol - IP for which the ZyWALL is configured. This field is not configurable.
Device Mode	This displays whether the ZyWALL is functioning as a router or a bridge.
Firewall	This displays whether or not the ZyWALL's firewall is activated.
System Time	This field displays your ZyWALL's present date and time along with the difference from the Greenwich Mean Time (GMT) zone. The difference from GMT is based on the time zone. It is also adjusted for Daylight Saving Time if you set the ZyWALL to use it.
Memory	<p>The first number shows how many kilobytes of the heap memory the ZyWALL is using. Heap memory refers to the memory that is not used by ZyNOS (ZyXEL Network Operating System) and is thus available for running processes like NAT, VPN and the firewall.</p> <p>The second number shows the ZyWALL's total heap memory (in kilobytes).</p> <p>The bar displays what percent of the ZyWALL's heap memory is in use. The bar turns from green to red when the maximum is being approached.</p>
Sessions	<p>The first number shows how many sessions are currently open on the ZyWALL. This includes all sessions that are currently:</p> <ul style="list-style-type: none"> • Traversing the ZyWALL • Terminating at the ZyWALL • Initiated from the ZyWALL <p>The second number is the maximum number of sessions that can be open at one time.</p> <p>The bar displays what percent of the maximum number of sessions is in use. The bar turns from green to red when the maximum is being approached.</p>
Policy Routes	<p>The first number shows how many policy routes you have configured.</p> <p>The second number shows the maximum number of policy routes that you can configure on the ZyWALL.</p> <p>The bar displays what percent of the ZyWALL's possible policy routes are configured. The bar turns from green to red when the maximum is being approached.</p>
Network Status	

Table 2 Web Configurator HOME Screen in Router Mode (continued)

LABEL	DESCRIPTION
Interface	This is the port type. Port types are: WAN1 , WAN2 , Dial Backup , LAN , WLAN and DMZ . Click "+" to expand or "-" to collapse the LAN and DMZ IP alias drop-down lists.
Status	For the LAN and DMZ ports, this displays the port speed and duplex setting. For the WAN and Dial Backup port, it displays the port speed and duplex setting if you're using Ethernet encapsulation and Down (line is down or not connected), Idle (line (ppp) idle), Dial (starting to trigger a call) or Drop (dropping a call) if you're using PPPoE encapsulation. For the WLAN port, it displays Active when WLAN is enabled or Inactive when WLAN is disabled.
IP Address	This shows the port's IP address.
Subnet Mask	This shows the port's subnet mask.
DHCP	This shows the WAN port's DHCP role - Client or None . This shows the LAN port's DHCP role - Server , Relay or None .
Renew	If you are using Ethernet encapsulation and the WAN port is configured to get the IP address automatically from the ISP, click Renew to release the WAN port's dynamically assigned IP address and get the IP address afresh. Click Dial to dial up the PPTP, PPPoE or dial backup connection.
Show Statistics	Click Show Statistics to see router performance statistics such as the number of packets sent and number of packets received for each port, including WAN1, WAN2, Dial Backup, LAN, WLAN and DMZ.
Show DHCP Table	Click Show DHCP Table to show current DHCP client information.
VPN Status	Click VPN Status to display the active VPN connections.

2.4.2 Bridge Mode

The following screen displays when the ZyWALL is set to bridge mode. While in bridge mode, the ZyWALL cannot get an IP address from a DHCP server. The LAN, WAN, DMZ and WLAN interfaces all have the same (static) IP address and subnet mask. You can configure the ZyWALL's IP address in order to access the ZyWALL for management. If you connect your computer directly to the ZyWALL, you also need to assign your computer a static IP address in the same subnet as the ZyWALL's IP address in order to access the ZyWALL.

The ZyWALL bridges traffic traveling between the ZyWALL's interfaces.

You can use the firewall in bridge mode (refer to the firewall chapters for details on configuring the firewall).

Figure 8 Web Configurator HOME Screen in Bridge Mode

Device Information

System Name: _____
 Firmware Version: V3.64(WM.0)b3 | 02/03/2005
 Device Mode: Bridge
 Firewall: Enabled
 System Time: 2001-01-01 01:50:09 GMT
 Memory: 14548K/18763K
 Sessions: 2/10000

Network Status

IP Address: 192.168.1.2
 Subnet Mask: 255.255.255.0
 Gateway IP Address: 0.0.0.0
 Rapid Spanning Tree Protocol: Disabled
 Bridge Priority : 250
 Bridge Hello Time : 2 second(s)
 Bridge Max Age : 20 second(s)
 Forward Delay : 15 second(s)

Bridge Port	Port Status	RSTP Status	RSTP Active	RSTP Priority	RSTP Path Cost
WAN1	Down	N/A	No	128	250
WAN2	Down	N/A	No	128	250
LAN	100M/Full	N/A	No	128	250
WLAN	Down	N/A	No	128	250
DMZ	100M/Full	N/A	No	128	250

Show Statistics

Status: Ready

The following table describes the labels not previously discussed (see [Table 2 on page 63](#)).

Table 3 Web Configurator HOME Screen in Bridge Mode

LABEL	DESCRIPTION
Network Status	
IP Address	This is the IP address of your ZyWALL in dotted decimal notation.
Subnet Mask	This is the IP subnet mask of the ZyWALL.
Gateway IP Address	This is the gateway IP address.
Rapid Spanning Tree Protocol	This shows whether RSTP (Rapid Spanning Tree Protocol) is active or not. The following labels or values relative to RSTP do not apply when RSTP is disabled.
Bridge Priority	This is the bridge priority of the ZyWALL.
Bridge Hello Time	This is the interval of BPDUs (Bridge Protocol Data Units) from the root bridge.
Bridge Max Age	This is the predefined interval that a bridge waits to get a Hello message (BPDU) from the root bridge.
Forward Delay	This is the forward delay interval.
Bridge Port	This is the port type. Port types are: WAN1, WAN2, LAN, WLAN and DMZ.

Table 3 Web Configurator HOME Screen in Bridge Mode (continued)

LABEL	DESCRIPTION
Port Status	For the WAN, LAN, and DMZ ports, this displays the port speed and duplex setting. For the WAN port, it displays Down when the link is not ready or has failed. For the WLAN port, it displays Active when WLAN is enabled or Inactive when WLAN is disabled.
RSTP Status	This is the RSTP status of the corresponding port.
RSTP Active	This shows whether or not RSTP is active on the corresponding port.
RSTP Priority	This is the RSTP priority of the corresponding port.
RSTP Path Cost	This is the cost of transmitting a frame from the root bridge to the corresponding port.
Show Statistics	Click Show Statistics to see bridge performance statistics such as the number of packets sent and number of packets received for each port, including WAN1, WAN2, LAN, DMZ and WLAN.

2.4.3 Navigation Panel

After you enter the password, use the sub-menus on the navigation panel to configure ZyWALL features.

The following table lists the features available for each device mode.

Table 4 Bridge and Router Mode Features Comparison

FEATURE	BRIDGE MODE	ROUTER MODE
Internet Access Wizard		O
VPN Wizard		O
DHCP Table		O
System Statistics	O	O
LAN		O
Bridge	O	
Wireless LAN	O	O
WAN		O
DMZ		O
Firewall	O	O
Content Filter	O	O
VPN		O
Certificates	O	O
Authentication Server	O	O
NAT		O
Static Route		O
Bandwidth Management	O	O
DNS		O
Remote Management	O	O

Table 4 Bridge and Router Mode Features Comparison

FEATURE	BRIDGE MODE	ROUTER MODE
UPnP		O
Logs	O	O
Maintenance	O	O

Table Key: An O in a mode's column shows that the device mode has the specified feature. The information in this table was correct at the time of writing, although it may be subject to change.

The following table describes the sub-menus.

Table 5 Screens Summary

LINK	TAB	FUNCTION
HOME		This screen shows the ZyWALL's general device and network status information. Use this screen to access the wizards, statistics and DHCP table.
LAN	LAN	Use this screen to configure LAN DHCP and TCP/IP settings.
	Static DHCP	Use this screen to assign fixed IP addresses on the LAN.
	IP Alias	Use this screen to partition your LAN interface into subnets.
BRIDGE	Bridge	Use this screen to change the bridge settings on the ZyWALL.
WIRELESS LAN	Wireless	Use this screen to configure the wireless LAN settings and WLAN authentication/security settings.
	MAC Filter	Use this screen to change MAC filter settings on the ZyWALL.
WAN	General	This screen allows you to configure load balancing, route priority and traffic redirect properties.
	WAN1	Use this screen to configure ZyWALL WAN1 port for internet access.
	WAN2	Use this screen to change your WAN2 port settings.
	Traffic Redirect	Use this screen to configure your traffic redirect properties and parameters.
	Dial Backup	Use this screen to configure the backup WAN dial-up connection.
DMZ	DMZ	Use this screen to configure your DMZ connection.
	IP Alias	Use this screen to partition your DMZ interface into subnets.
FIREWALL	Default Rule	Use this screen to activate/deactivate the firewall and the direction of network traffic to which to apply the rule.
	Rule Summary	This screen shows a summary of the firewall rules, and allows you to edit/add a firewall rule.
	Anti-Probing	Use this screen to change your anti-probing settings.
	Threshold	Use this screen to configure the threshold for DoS attacks.
CONTENT FILTER	General	This screen allows you to enable content filtering and block certain web features.
	Categories	Use this screen to select which categories of web pages to filter out, as well as to register for external database content filtering and view reports.

Table 5 Screens Summary (continued)

LINK	TAB	FUNCTION
	Customization	Use this screen to customize the content filter list.
VPN	VPN Rules (IKE)	Use this screen to configure VPN connections using IKE key management and view the rule summary.
	VPN Rules (Manual)	Use this screen to configure VPN connections using manual key management and view the rule summary.
	SA Monitor	Use this screen to display and manage active VPN connections.
	Global Setting	Use this screen to configure the IPSec timer settings.
CERTIFICATES	My Certificates	Use this screen to view a summary list of certificates and manage certificates and certification requests.
	Trusted CAs	Use this screen to view and manage the list of the trusted CAs.
	Trusted Remote Hosts	Use this screen to view and manage the certificates belonging to the trusted remote hosts.
	Directory Servers	Use this screen to view and manage the list of the directory servers.
AUTH SERVER	Local User Database	Use this screen to configure the local user account(s) on the ZyWALL.
	RADIUS	Configure this screen to use an external server to authenticate wireless and/or VPN users.
NAT	NAT Overview	Use this screen to enable NAT.
	Address Mapping	Use this screen to configure network address translation mapping rules.
	Port Forwarding	Use this screen to configure servers behind the ZyWALL.
	Port Triggering	Use this screen to change your ZyWALL's port triggering settings.
STATIC ROUTE	IP Static Route	Use this screen to configure IP static routes.
POLICY ROUTE	Policy Rout Summary	Use this screen to view a summary list of all the policies and configure policies for use in IP policy routing.
BW MGMT	Summary	Use this screen to enable bandwidth management on an interface.
	Class Setup	Use this screen to set up the bandwidth classes.
	Monitor	Use this screen to view the ZyWALL's bandwidth usage and allotments.
DNS	System	Use this screen to configure the address and name server records.
	Cache	Use this screen to configure the DNS resolution cache.
	LAN	Use this screen to configure LAN DNS information.
	DDNS	Use this screen to set up dynamic DNS.
REMOTE MGMT	WWW	Use this screen to configure through which interface(s) and from which IP address(es) users can use HTTPS or HTTP to manage the ZyWALL.
	SSH	Use this screen to configure through which interface(s) and from which IP address(es) users can use Secure Shell to manage the ZyWALL.
	TELNET	Use this screen to configure through which interface(s) and from which IP address(es) users can use Telnet to manage the ZyWALL.

Table 5 Screens Summary (continued)

LINK	TAB	FUNCTION
	FTP	Use this screen to configure through which interface(s) and from which IP address(es) users can use FTP to access the ZyWALL.
	SNMP	Use this screen to configure your ZyWALL's settings for Simple Network Management Protocol management.
	DNS	Use this screen to configure through which interface(s) and from which IP address(es) users can send DNS queries to the ZyWALL.
	CNM	Use this screen to configure and allow your ZyWALL to be managed by the Vantage CNM server.
UPnP	UPnP	Use this screen to enable UPnP on the ZyWALL.
	Ports	Use this screen to view the NAT port mapping rules that UPnP creates on the ZyWALL.
LOGS	View Log	Use this screen to view the logs for the categories that you selected.
	Log Settings	Use this screen to change your ZyWALL's log settings.
	Reports	Use this screen to have the ZyWALL record and display the network usage reports.
MAINTENANCE	General	This screen contains administrative.
	Password	Use this screen to change your password.
	Time and Date	Use this screen to change your ZyWALL's time and date.
	Device Mode	Use this screen to configure and have your ZyWALL work as a router or a bridge.
	F/W Upload	Use this screen to upload firmware to your ZyWALL
	Configuration	Use this screen to backup and restore the configuration or reset the factory defaults to your ZyWALL.
	Restart	This screen allows you to reboot the ZyWALL without turning the power off.
LOGOUT		Click this label to exit the web configurator.

2.4.4 System Statistics

Click **Show Statistics** in the **HOME** screen. Read-only information here includes port status and packet specific statistics. Also provided is "Up Time" and "poll interval(s)". The **Poll Interval(s)** field is configurable.

Figure 9 Home : Show Statistics



The following table describes the labels in this screen.

Table 6 Home: Show Statistics

LABEL	DESCRIPTION
	Click the icon to display the chart of throughput statistics.
Port	This is the WAN1, WAN2, Dial Backup, LAN, DMZ or WLAN port.
Status	This displays the port speed and duplex setting if you're using Ethernet encapsulation and Down (line is down), Idle (line (ppp) idle), Dial (starting to trigger a call) or Drop (dropping a call) if you're using PPPoE encapsulation.
TxPkts	This is the number of transmitted packets on this port.
RxPkts	This is the number of received packets on this port.
Tx B/s	This displays the transmission speed in bytes per second on this port.
Rx B/s	This displays the reception speed in bytes per second on this port.
Up Time	This is the total amount of time the line has been up.
System Up Time	This is the total time the ZyWALL has been on.
Poll Interval(s)	Enter the time interval for refreshing statistics in this field.
Set Interval	Click this button to apply the new poll interval you entered in the Poll Interval(s) field.
Stop	Click Stop to stop refreshing statistics.

2.4.4.1 Show Statistics: Line Chart

Click the icon in the **Show Statistics** screen. The screen shows you the line chart of each port's throughput statistics.

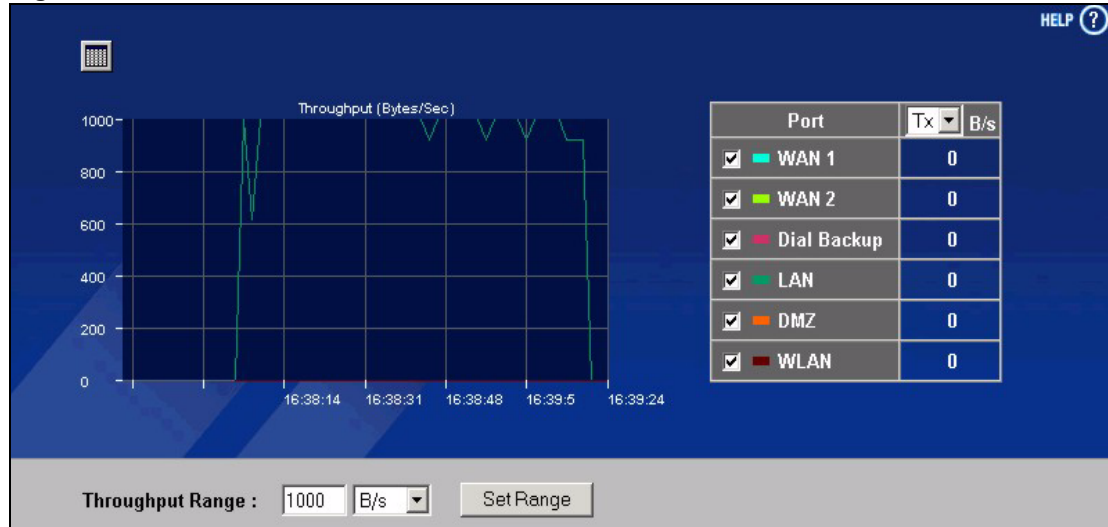
Figure 10 Home : Show Statistics: Line Chart

The following table describes the labels in this screen.

Table 7 Home: Show Statistics: Line Chart

LABEL	DESCRIPTION
	Click the icon to go back to the Show Statistics screen.
Port	Select the check box(es) to display the throughput statistics of the corresponding port(s).
B/s	Specify the direction of the traffic for which you want to show throughput statistics in this table. Select Tx to display transmitted traffic throughput statistics and the amount of traffic (in bytes). Select Rx to display received traffic throughput statistics and the amount of traffic (in bytes).
Throughput Range	Set the range of the throughput (in B/s , KB/s or MB/s) to display. Click Set Range to save this setting back to the ZyWALL.

2.4.5 DHCP Table Screen

DHCP (Dynamic Host Configuration Protocol, RFC 2131 and RFC 2132) allows individual clients to obtain TCP/IP configuration at start-up from a server. You can configure the ZyWALL as a DHCP server or disable it. When configured as a server, the ZyWALL provides the TCP/IP configuration for the clients. If DHCP service is disabled, you must have another DHCP server on your LAN, or else the computer must be manually configured.

Click **Show DHCP Table** in the **HOME** screen when the ZyWALL is set to router mode. Read-only information here relates to your DHCP status. The DHCP table shows current DHCP client information (including **IP Address**, **Host Name** and **MAC Address**) of all network clients using the ZyWALL's DHCP server.

Figure 11 Home : DHCP Table

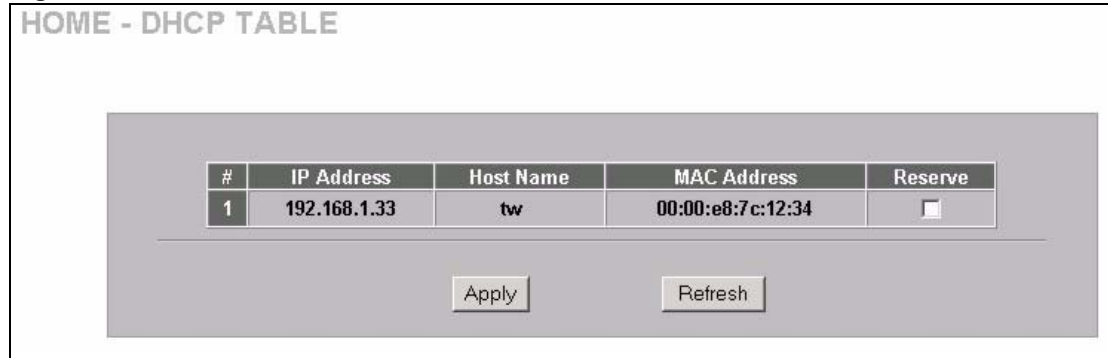

The following table describes the labels in this screen.

Table 8 Home: DHCP Table

LABEL	DESCRIPTION
#	This is the index number of the host computer.
IP Address	This field displays the IP address relative to the # field listed above.
Host Name	This field displays the computer host name.
MAC Address	The MAC (Media Access Control) or Ethernet address on a LAN (Local Area Network) is unique to your computer (six pairs of hexadecimal notation). A network interface card such as an Ethernet adapter has a hardwired address that is assigned at the factory. This address follows an industry standard that ensures no other adapter has a similar address.
Reserve	Select this check box to have the ZyWALL always assign this IP address to this MAC address (and host name). You can select up to 8 entries in this table. After you click Apply , the MAC address and IP address also display in the LAN Static DHCP screen (where you can edit them).
Refresh	Click Refresh to reload the DHCP table.

2.4.6 VPN Status

Click **VPN Status** in the **HOME** screen when the ZyWALL is set to router mode. Read-only information here includes encapsulation mode and security protocol. The **Poll Interval(s)** field is configurable.

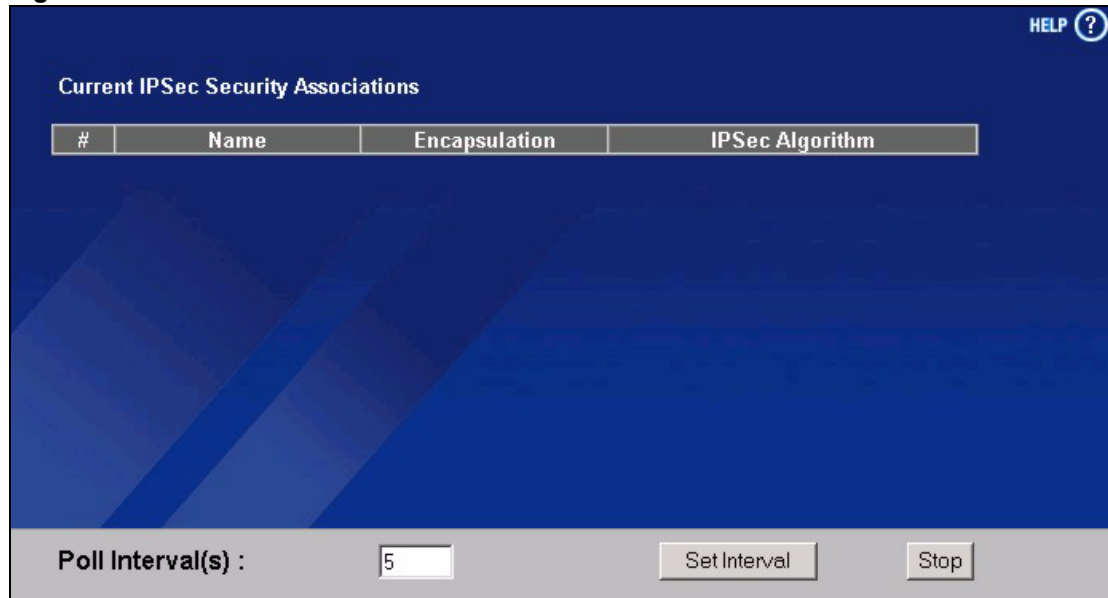
Figure 12 Home : VPN Status

The following table describes the labels in this screen.

Table 9 Home : VPN Status

LABEL	DESCRIPTION
#	This is the security association index number.
Name	This field displays the identification name for this VPN policy.
Encapsulation	This field displays Tunnel or Transport mode.
IPSec Algorithm	This field displays the security protocols used for an SA. Both AH and ESP increase ZyWALL processing requirements and communications latency (delay).
Poll Interval(s)	Enter the time interval for refreshing statistics in this field.
Set Interval	Click this button to apply the new poll interval you entered in the Poll Interval(s) field.
Stop	Click Stop to stop refreshing statistics.

CHAPTER 3

Wizard Setup

This chapter provides information on the **Wizard Setup** screens in the web configurator. This chapter is only applicable when the ZyWALL is in router mode.

3.1 Wizard Setup Overview

The web configurator's setup wizards help you configure **WAN1** on the ZyWALL to access the Internet and edit VPN policies and configure IKE settings to establish a VPN tunnel.

3.2 Internet Access

The Internet access wizard screen has three variations depending on what encapsulation type you use. Refer to information provided by your ISP to know what to enter in each field. Leave a field blank if you don't have that information.

3.2.1 ISP Parameters

The ZyWALL offers three choices of encapsulation. They are **Ethernet**, **PPTP** or **PPPoE**.

The wizard screen varies according to the type of encapsulation that you select in the **Encapsulation** field.

3.2.1.1 Ethernet

For ISPs (such as Telstra) that send UDP heartbeat packets to verify that the customer is still online, please create a **WAN-to-WAN/ZyWALL** firewall rule for those packets. Contact your ISP to find the correct port number.

Choose **Ethernet** when the WAN port is used as a regular Ethernet.

Figure 13 ISP Parameters : Ethernet Encapsulation

The following table describes the labels in this screen.

Table 10 ISP Parameters : Ethernet Encapsulation

LABEL	DESCRIPTION
ISP Parameters for Internet Access	
Encapsulation	You must choose the Ethernet option when the WAN port is used as a regular Ethernet. Otherwise, choose PPPoE or PPTP for a dial-up connection.
WAN IP Address Assignment	
IP Address Assignment	Select Dynamic If your ISP did not assign you a fixed IP address. This is the default selection. Select Static If the ISP assigned a fixed IP address. The fields below are available only when you select Static .
My WAN IP Address	Enter your WAN IP address in this field.
My WAN IP Subnet Mask	Enter the IP subnet mask in this field.
Gateway IP Address	Enter the gateway IP address in this field.

Table 10 ISP Parameters : Ethernet Encapsulation

LABEL	DESCRIPTION
First DNS Server	Enter the DNS server's IP address(es) in the field(s) to the right.
Second DNS Server	Leave the field as 0.0.0.0 if you do not want to configure DNS servers. If you do not configure a DNS server, you must know the IP address of a machine in order to access it.
Finish	Click Finish to complete and save the wizard setup.

3.2.1.2 PPPoE Encapsulation

Point-to-Point Protocol over Ethernet (PPPoE) functions as a dial-up connection. PPPoE is an IETF (Internet Engineering Task Force) draft standard specifying how a host personal computer interacts with a broadband modem (for example xDSL, cable, wireless, etc.) to achieve access to high-speed data networks. It preserves the existing Microsoft Dial-Up Networking experience and requires no new learning or procedures.

Figure 14 ISP Parameters : PPPoE Encapsulation

WIZARD - Internet Access

ISP Parameters for Internet Access

You can select ethernet, PPPoE or PPTP according to in which the network you are. If you don't know, please ask your network administrator. The most popular type of network is ethernet.

Encapsulation: PPP over Ethernet

Service Name: (Optional)

User Name: []

Password: []

Retype to Confirm: []

Nailed-Up

Idle Timeout: 100 (Seconds)

WAN IP Address Assignment

IP Address Assignment: Static

My WAN IP Address: 0 . 0 . 0 . 0

First DNS Server: 0 . 0 . 0 . 0

Second DNS Server: 0 . 0 . 0 . 0

Finish

The following table describes the labels in this screen.

Table 11 ISP Parameters: PPPoE Encapsulation

LABEL	DESCRIPTION
ISP Parameter for Internet Access	
Encapsulation	Choose an encapsulation method from the pull-down list box. PPP over Ethernet forms a dial-up connection.
Service Name	Type the name of your service provider.
User Name	Type the user name given to you by your ISP.
Password	Type the password associated with the user name above.
Retype to Confirm	Type your password again for confirmation.
Nailed-Up	Select Nailed-Up if you do not want the connection to time out.
Idle Timeout	Type the time in seconds that elapses before the router automatically disconnects from the PPPoE server. The default time is 100 seconds.
WAN IP Address Assignment	
IP Address Assignment	Select Dynamic if your ISP did not assign you a fixed IP address. This is the default selection. Select Static if the ISP assigned a fixed IP address. The fields below are available only when you select Static .
My WAN IP Address	Enter your WAN IP address in this field.
First DNS Server Second DNS Server	Enter the DNS server's IP address(es) in the field(s) to the right. Leave the field as 0.0.0.0 if you do not want to configure DNS servers. If you do not configure a DNS server, you must know the IP address of a machine in order to access it.
Finish	Click Finish to complete and save the wizard setup.

3.2.1.3 PPTP Encapsulation

Point-to-Point Tunneling Protocol (PPTP) is a network protocol that enables transfers of data from a remote client to a private server, creating a Virtual Private Network (VPN) using TCP/IP-based networks.

PPTP supports on-demand, multi-protocol, and virtual private networking over public networks, such as the Internet.

Refer to [Appendix F on page 605](#) for more information on PPTP.

Note: The ZyWALL supports one PPTP server connection at any given time.

Figure 15 ISP Parameters: PPTP Encapsulation

WIZARD - Internet Access

ISP Parameters for Internet Access

You can select ethernet, PPPoE or PPTP according to in which the network you are. If you don't know, please ask your network administrator. The most popular type of network is ethernet.

Encapsulation: PPTP

User Name: _____

Password: _____

Retype to Confirm: _____

Nailed-Up

Idle Timeout: 0 (Seconds)

PPTP Configuration

My IP Address: 0 . 0 . 0 . 0

My IP Subnet Mask: 0 . 0 . 0 . 0

Server IP Address: 0 . 0 . 0 . 0

Connection ID/Name: _____

WAN IP Address Assignment

IP Address Assignment: Static

My WAN IP Address: 0 . 0 . 0 . 0

First DNS Server: 0 . 0 . 0 . 0

Second DNS Server: 0 . 0 . 0 . 0

Finish

The following table describes the labels in this screen.

Table 12 ISP Parameters : PPTP Encapsulation

LABEL	DESCRIPTION
ISP Parameters for Internet Access	
Encapsulation	Select PPTP from the drop-down list box. To configure a PPTP client, you must configure the User Name and Password fields for a PPP connection and the PPTP parameters for a PPTP connection.
User Name	Type the user name given to you by your ISP.
Password	Type the password associated with the User Name above.
Retype to Confirm	Type your password again for confirmation.
Nailed-Up	Select Nailed-Up if you do not want the connection to time out.

Table 12 ISP Parameters : PPTP Encapsulation

LABEL	DESCRIPTION
Idle Timeout	Type the time in seconds that elapses before the router automatically disconnects from the PPTP server.
PPTP Configuration	
My IP Address	Type the (static) IP address assigned to you by your ISP.
My IP Subnet Mask	Type the subnet mask assigned to you by your ISP (if given).
Server IP Address	Type the IP address of the PPTP server.
Connection ID/ Name	Enter the connection ID or connection name in this field. It must follow the "c:id" and "n:name" format. For example, C:12 or N:My ISP. This field is optional and depends on the requirements of your xDSL modem.
WAN IP Address Assignment	
IP Address Assignment	Select Dynamic If your ISP did not assign you a fixed IP address. This is the default selection. Select Static If the ISP assigned a fixed IP address. The fields below are available only when you select Static .
My WAN IP Address	Enter your WAN IP address in this field.
First DNS Server Second DNS Server	Enter the DNS server's IP address(es) in the field(s) to the right. Leave the field as 0.0.0.0 if you do not want to configure DNS servers. If you do not configure a DNS server, you must know the IP address of a machine in order to access it.
Finish	Click Finish to complete and save the wizard setup.

3.2.2 Internet Access Wizard Setup Complete

Well done! You have successfully set up your ZyWALL to operate on your network and access the Internet.

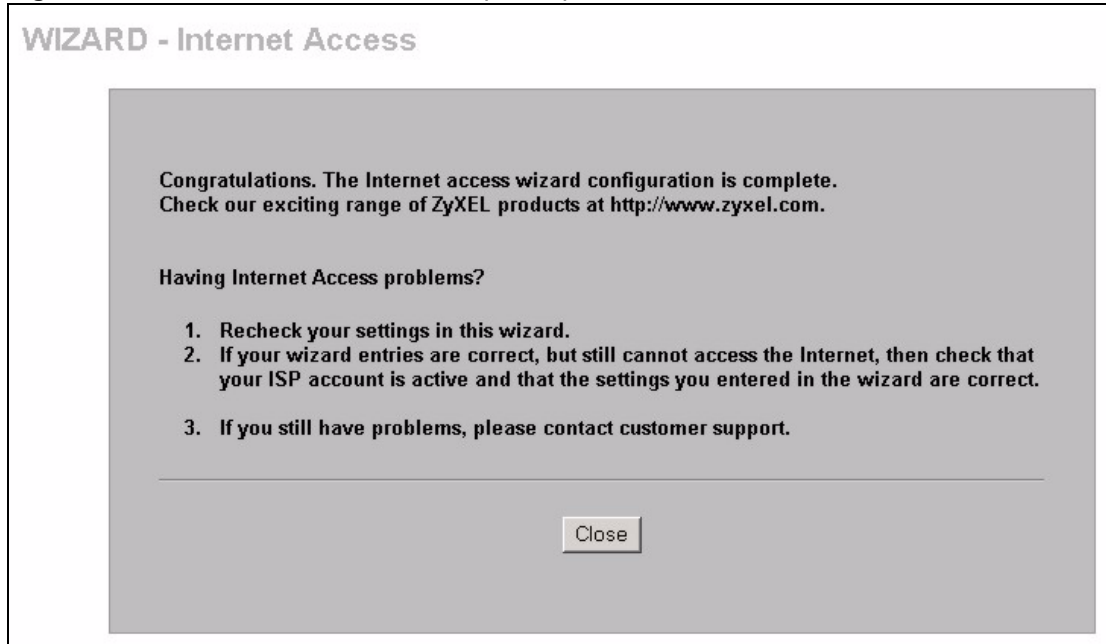
Figure 16 Internet Access Wizard Setup Complete

3.3 VPN Wizard

Use the VPN wizard screens to configure a VPN rule that use a pre-shared key. If you want to set the rule to use a certificate, please go to the VPN screens for configuration.

Click **VPN Wizard** in the **HOME** screen to open the screen as shown and have the quick and initial VPN configuration.

Figure 17 VPN Wizard: Gateway Setting

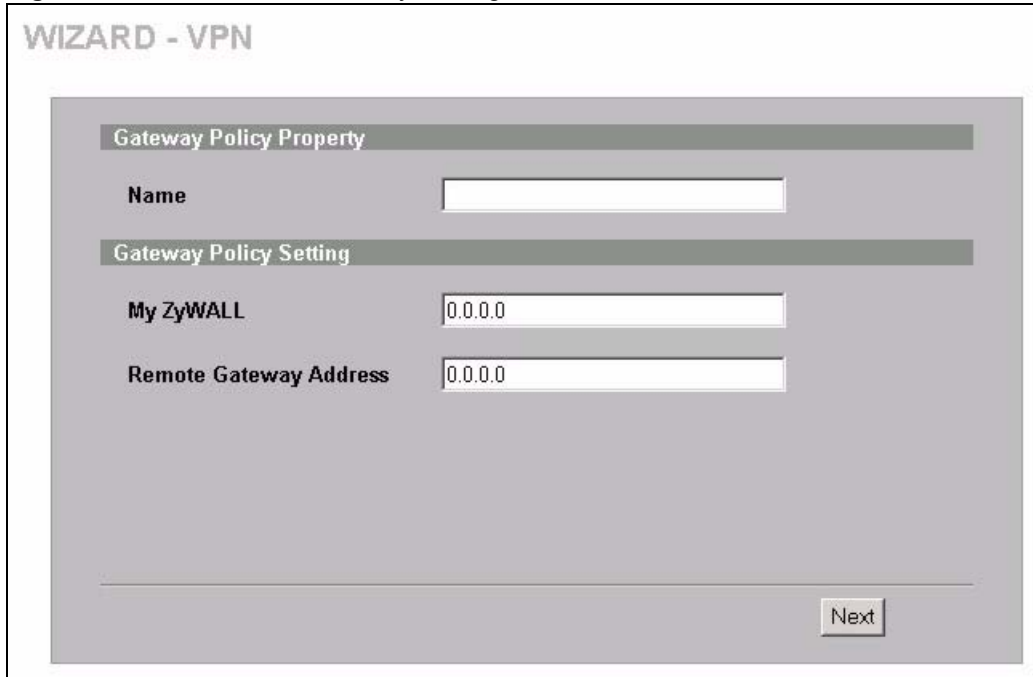

The following table describes the labels in this screen.

Table 13 VPN Wizard: Gateway Setting

LABEL	DESCRIPTION
Gateway Policy Property	
Name	Type up to 32 characters to identify this VPN gateway policy. You may use any character, including spaces, but the ZyWALL drops trailing spaces.
My ZyWALL	<p>Enter the WAN IP address or the domain name of your ZyWALL or leave the field set to 0.0.0.0.</p> <p>The following applies if the My ZyWALL field is configured as 0.0.0.0:</p> <ul style="list-style-type: none"> • When the WAN port operation mode is set to Active/Passive, the ZyWALL uses the IP address (static or dynamic) of the WAN port that is in use. • When the WAN port operation mode is set to Active/Active, the ZyWALL uses the IP address (static or dynamic) of the primary (highest priority) WAN port to set up the VPN tunnel as long as the corresponding WAN1 or WAN2 connection is up. If the corresponding WAN1 or WAN2 connection goes down, the ZyWALL uses the IP address of the other WAN port. • If both WAN connections go down, the ZyWALL uses the dial backup IP address for the VPN tunnel when using dial backup or the LAN IP address when using traffic redirect. See the chapter on WAN for details on dial backup and traffic redirect. <p>The VPN tunnel has to be rebuilt if this IP address changes.</p>
Remote Gateway Address	Enter the WAN IP address or domain name of the remote IPsec router (secure gateway) in the field below to identify the remote IPsec router by its IP address or a domain name. Set this field to 0.0.0.0 if the remote IPsec router has a dynamic WAN IP address.
Next	Click Next to continue.

3.3.1 Network Setting

Two active SAs cannot have the local and remote IP address(es) both the same. Two active SAs can have the same local or remote IP address, but not both. You can configure multiple SAs between the same local and remote IP addresses, as long as only one is active at any time.

Figure 18 VPN Wizard: Network Setting

The following table describes the labels in this screen.

Table 14 VPN Wizard : Network Setting

LABEL	DESCRIPTION
Network Policy Property	
Active	If the Active check box is selected, packets for the tunnel trigger the ZyWALL to build the tunnel. Clear the Active check box to turn the network policy off. The ZyWALL does not apply the policy. Packets for the tunnel do not trigger the tunnel.
Name	Type up to 32 characters to identify this VPN network policy. You may use any character, including spaces, but the ZyWALL drops trailing spaces.
Network Policy Setting	
Local Network	Local IP addresses must be static and correspond to the remote IPSec router's configured remote IP addresses. Select Single for a single IP address. Select Range IP for a specific range of IP addresses. Select Subnet to specify IP addresses on a network by their subnet mask.

Table 14 VPN Wizard : Network Setting

LABEL	DESCRIPTION
Starting IP Address	When the Local Network field is configured to Single , enter a (static) IP address on the LAN behind your ZyWALL. When the Local Network field is configured to Range IP , enter the beginning (static) IP address, in a range of computers on the LAN behind your ZyWALL. When the Local Network field is configured to Subnet , this is a (static) IP address on the LAN behind your ZyWALL.
Ending IP Address/ Subnet Mask	When the Local Network field is configured to Single , this field is N/A. When the Local Network field is configured to Range IP , enter the end (static) IP address, in a range of computers on the LAN behind your ZyWALL. When the Local Network field is configured to Subnet , this is a subnet mask on the LAN behind your ZyWALL.
Remote Network	Remote IP addresses must be static and correspond to the remote IPsec router's configured local IP addresses. Select Single for a single IP address. Select Range IP for a specific range of IP addresses. Select Subnet to specify IP addresses on a network by their subnet mask.
Starting IP Address	When the Remote Network field is configured to Single , enter a (static) IP address on the network behind the remote IPsec router. When the Remote Network field is configured to Range IP , enter the beginning (static) IP address, in a range of computers on the network behind the remote IPsec router. When the Remote Network field is configured to Subnet , enter a (static) IP address on the network behind the remote IPsec router.
Ending IP Address/ Subnet Mask	When the Remote Network field is configured to Single , this field is N/A. When the Remote Network field is configured to Range IP , enter the end (static) IP address, in a range of computers on the network behind the remote IPsec router. When the Remote Network field is configured to Subnet , enter a subnet mask on the network behind the remote IPsec router.
Back	Click Back to return to the previous screen.
Next	Click Next to continue.

3.3.2 IKE Tunnel Setting (IKE Phase 1)

Figure 19 VPN Wizard: IKE Tunnel Setting

The screenshot shows a web-based configuration interface titled "WIZARD - VPN". The main heading is "IKE Tunnel Setting (IKE Phase 1)". The settings are as follows:

- Negotiation Mode:** Main Mode Aggressive Mode
- Encryption Algorithm:** DES AES 3DES
- Authentication Algorithm:** SHA1 MD5
- Key Group:** DH1 DH2
- SA Life Time:** 28800 (Seconds)
- Pre-Shared Key:** [Empty text box]

At the bottom right, there are "Back" and "Next" buttons.

The following table describes the labels in this screen.

Table 15 VPN Wizard: IKE Tunnel Setting

LABEL	DESCRIPTION
Negotiation Mode	Select Main Mode for identity protection. Select Aggressive Mode to allow more incoming connections from dynamic IP addresses to use separate passwords. Note: Multiple SAs (security associations) connecting through a secure gateway must have the same negotiation mode.
Encryption Algorithm	When DES is used for data communications, both sender and receiver must know the same secret key, which can be used to encrypt and decrypt the message or to generate and verify a message authentication code. The DES encryption algorithm uses a 56-bit key. Triple DES (3DES) is a variation on DES that uses a 168-bit key. As a result, 3DES is more secure than DES . It also requires more processing power, resulting in increased latency and decreased throughput. This implementation of AES uses a 128-bit key. AES is faster than 3DES .
Authentication Algorithm	MD5 (Message Digest 5) and SHA1 (Secure Hash Algorithm) are hash algorithms used to authenticate packet data. The SHA1 algorithm is generally considered stronger than MD5 , but is slower. Select MD5 for minimal security and SHA-1 for maximum security.
Key Group	You must choose a key group for phase 1 IKE setup. DH1 (default) refers to Diffie-Hellman Group 1 a 768 bit random number. DH2 refers to Diffie-Hellman Group 2 a 1024 bit (1Kb) random number.

Table 15 VPN Wizard: IKE Tunnel Setting (continued)

LABEL	DESCRIPTION
SA Life Time (Seconds)	<p>Define the length of time before an IKE SA automatically renegotiates in this field. The minimum value is 180 seconds.</p> <p>A short SA Life Time increases security by forcing the two VPN gateways to update the encryption and authentication keys. However, every time the VPN tunnel renegotiates, all users accessing remote resources are temporarily disconnected.</p>
Pre-Shared Key	<p>Type your pre-shared key in this field. A pre-shared key identifies a communicating party during a phase 1 IKE negotiation. It is called "pre-shared" because you have to share it with another party before you can communicate with them over a secure connection.</p> <p>Type from 8 to 31 case-sensitive ASCII characters or from 16 to 62 hexadecimal ("0-9", "A-F") characters. You must precede a hexadecimal key with a "0x (zero x)", which is not counted as part of the 16 to 62 character range for the key. For example, in "0x0123456789ABCDEF", 0x denotes that the key is hexadecimal and 0123456789ABCDEF is the key itself.</p> <p>Both ends of the VPN tunnel must use the same pre-shared key. You will receive a PYLD_MALFORMED (payload malformed) packet if the same pre-shared key is not used on both ends.</p>
Back	Click Back to return to the previous screen.
Next	Click Next to continue.

3.3.3 IPsec Setting (IKE Phase 2)

Figure 20 VPN Wizard: IPsec Setting

The following table describes the labels in this screen.

Table 16 VPN Wizard: IPsec Setting

LABEL	DESCRIPTION
Encapsulation Mode	Tunnel is compatible with NAT, Transport is not. Tunnel mode encapsulates the entire IP packet to transmit it securely. A Tunnel mode is required for gateway services to provide access to internal systems. Tunnel mode is fundamentally an IP tunnel with authentication and encryption. Transport mode is used to protect upper layer protocols and only affects the data in the IP packet. In Transport mode, the IP packet contains the security protocol (AH or ESP) located after the original IP header and options, but before any upper layer protocols contained in the packet (such as TCP and UDP).
IPsec Protocol	Select the security protocols used for an SA. Both AH and ESP increase ZyWALL processing requirements and communications latency (delay).
Encryption Algorithm	When DES is used for data communications, both sender and receiver must know the same secret key, which can be used to encrypt and decrypt the message or to generate and verify a message authentication code. The DES encryption algorithm uses a 56-bit key. Triple DES (3DES) is a variation on DES that uses a 168-bit key. As a result, 3DES is more secure than DES . It also requires more processing power, resulting in increased latency and decreased throughput. This implementation of AES uses a 128-bit key. AES is faster than 3DES . Select NULL to set up a tunnel without encryption. When you select NULL , you do not enter an encryption key.
Authentication Algorithm	MD5 (Message Digest 5) and SHA1 (Secure Hash Algorithm) are hash algorithms used to authenticate packet data. The SHA1 algorithm is generally considered stronger than MD5 , but is slower. Select MD5 for minimal security and SHA-1 for maximum security.

Table 16 VPN Wizard: IPSec Setting (continued)

LABEL	DESCRIPTION
SA Life Time (Seconds)	Define the length of time before an IKE SA automatically renegotiates in this field. The minimum value is 180 seconds. A short SA Life Time increases security by forcing the two VPN gateways to update the encryption and authentication keys. However, every time the VPN tunnel renegotiates, all users accessing remote resources are temporarily disconnected.
Perfect Forward Secret (PFS)	Perfect Forward Secret (PFS) is disabled (None) by default in phase 2 IPSec SA setup. This allows faster IPSec setup, but is not so secure. Select DH1 or DH2 to enable PFS. DH1 refers to Diffie-Hellman Group 1 a 768 bit random number. DH2 refers to Diffie-Hellman Group 2 a 1024 bit (1Kb) random number (more secure, yet slower).
Back	Click Back to return to the previous screen.
Next	Click Next to continue.

3.3.4 VPN Status Summary

This read-only screen shows the status of the current VPN setting. Use the summary table to check whether what you have configured is correct.

Figure 21 VPN Wizard: VPN Status

WIZARD - VPN

Status

Gateway Policy Property	
Name	HQ
Gateway Policy Setting	
My ZyWALL	0.0.0.0
Remote Gateway Address	0.0.0.0
Network Policy Property	
Active	Yes
Name	test
Network Policy Setting	
Local Network	
Starting IP Address	0.0.0.0
Ending IP Address	N/A
Remote Network	
Starting IP Address	0.0.0.0
Ending IP Address	N/A
IKE Tunnel Setting (IKE Phase 1)	
Negotiation Mode	Main Mode
Encryption Algorithm	DES
Authentication Algorithm	MD5
Key Group	DH1
SA Life Time	28800 (Seconds)
Pre-Shared Key	qwerty12345
IPsec Setting (IKE Phase 2)	
Encapsulation Mode	Tunnel Mode
IPsec Protocol	ESP
Encryption Algorithm	DES
Authentication Algorithm	SHA1
SA Life Time	28800 (Seconds)
Perfect Forward Secret (PFS)	None

Back Finish

The following table describes the labels in this screen.

Table 17 VPN Wizard: VPN Status

LABEL	DESCRIPTION
Gateway Policy Property	
Name	This is the name of this VPN gateway policy.
Gateway Policy Setting	
My ZyWALL	This is the WAN IP address or the domain name of your ZyWALL.
Remote Gateway Address	This is the IP address or the domain name used to identify the remote IPsec router.
Network Policy Property	

Table 17 VPN Wizard: VPN Status (continued)

LABEL	DESCRIPTION
Active	This displays whether this VPN network policy is enabled or not.
Name	This is the name of this VPN network policy.
Network Policy Setting	
Local Network	
Starting IP Address	This is a (static) IP address on the LAN behind your ZyWALL.
Ending IP Address/ Subnet Mask	When the local network is configured for a single IP address, this field is N/A. When the local network is configured for a range IP address, this is the end (static) IP address, in a range of computers on the LAN behind your ZyWALL. When the local network is configured for a subnet, this is a subnet mask on the LAN behind your ZyWALL.
Remote Network	
Starting IP Address	This is a (static) IP address on the network behind the remote IPSec router.
Ending IP Address/ Subnet Mask	When the remote network is configured for a single IP address, this field is N/A. When the remote network is configured for a range IP address, this is the end (static) IP address, in a range of computers on the network behind the remote IPSec router. When the remote network is configured for a subnet, this is a subnet mask on the network behind the remote IPSec router.
IKE Tunnel Setting (IKE Phase 1)	
Negotiation Mode	This shows Main Mode or Aggressive Mode . Multiple SAs connecting through a secure gateway must have the same negotiation mode.
Encryption Algorithm	This is the method of data encryption. Options can be DES , 3DES or AES .
Authentication Algorithm	MD5 (Message Digest 5) and SHA1 (Secure Hash Algorithm) are hash algorithms used to authenticate packet data.
Key Group	This is the key group you chose for phase 1 IKE setup.
SA Life Time (Seconds)	This is the length of time before an IKE SA automatically renegotiates.
Pre-Shared Key	This is a pre-shared key identifying a communicating party during a phase 1 IKE negotiation.
IPSec Setting (IKE Phase 2)	
Encapsulation Mode	This shows Tunnel mode or Transport mode.
IPSec Protocol	ESP or AH are the security protocols used for an SA.
Encryption Algorithm	This is the method of data encryption. Options can be DES , 3DES , AES or NULL .
Authentication Algorithm	MD5 (Message Digest 5) and SHA1 (Secure Hash Algorithm) are hash algorithms used to authenticate packet data.
SA Life Time (Seconds)	This is the length of time before an IKE SA automatically renegotiates.
Perfect Forward Secret (PFS)	Perfect Forward Secret (PFS) is disabled (None) by default in phase 2 IPSec SA setup. Otherwise, DH1 or DH2 are selected to enable PFS.
Back	Click Back to return to the previous screen.
Finish	Click Finish to complete and save the wizard setup.

3.3.5 VPN Wizard Setup Complete

Congratulations! You have successfully set up the VPN rule after any existing rule(s) for your ZyWALL.

Figure 22 VPN Wizard Setup Complete



CHAPTER 4

LAN Screens

This chapter describes how to configure LAN settings. This chapter is only applicable when the ZyWALL is in router mode.

4.1 LAN Overview

Local Area Network (LAN) is a shared communication system to which many computers are attached. The LAN screens can help you configure a LAN DHCP server, manage IP addresses, and partition your physical network into logical networks.

4.2 DHCP Setup

DHCP (Dynamic Host Configuration Protocol, RFC 2131 and RFC 2132) allows individual clients to obtain TCP/IP configuration at start-up from a server. You can configure the ZyWALL as a DHCP server or disable it. When configured as a server, the ZyWALL provides the TCP/IP configuration for the clients. If DHCP service is disabled, you must have another DHCP server on your LAN, or else the computer must be manually configured.

4.2.1 IP Pool Setup

The ZyWALL is pre-configured with a pool of IP addresses for the DHCP clients (DHCP Pool). See the product specifications in the appendices. Do not assign static IP addresses from the DHCP pool to your LAN computers.

4.3 LAN TCP/IP

The ZyWALL has built-in DHCP server capability that assigns IP addresses and DNS servers to systems that support DHCP client capability.

4.3.1 Factory LAN Defaults

The LAN parameters of the ZyWALL are preset in the factory with the following values:

- IP address of 192.168.1.1 with subnet mask of 255.255.255.0 (24 bits)
- DHCP server enabled with 128 client IP addresses starting from 192.168.1.33.

These parameters should work for the majority of installations. If your ISP gives you explicit DNS server address(es), read the embedded web configurator help regarding what fields need to be configured.

4.3.2 IP Address and Subnet Mask

Similar to the way houses on a street share a common street name, so too do computers on a LAN share one common network number.

Where you obtain your network number depends on your particular situation. If the ISP or your network administrator assigns you a block of registered IP addresses, follow their instructions in selecting the IP addresses and the subnet mask.

If the ISP did not explicitly give you an IP network number, then most likely you have a single user account and the ISP will assign you a dynamic IP address when the connection is established. If this is the case, it is recommended that you select a network number from 192.168.0.0 to 192.168.255.0 and you must enable the Network Address Translation (NAT) feature of the ZyWALL. The Internet Assigned Number Authority (IANA) reserved this block of addresses specifically for private use; please do not use any other number unless you are told otherwise. Let's say you select 192.168.1.0 as the network number; which covers 254 individual addresses, from 192.168.1.1 to 192.168.1.254 (zero and 255 are reserved). In other words, the first three numbers specify the network number while the last number identifies an individual computer on that network.

Once you have decided on the network number, pick an IP address that is easy to remember, for instance, 192.168.1.1, for your ZyWALL, but make sure that no other device on your network is using that IP address.

The subnet mask specifies the network number portion of an IP address. Your ZyWALL will compute the subnet mask automatically based on the IP address that you entered. You don't need to change the subnet mask computed by the ZyWALL unless you are instructed to do otherwise.

4.3.3 RIP Setup

RIP (Routing Information Protocol, RFC 1058 and RFC 1389) allows a router to exchange routing information with other routers. **RIP Direction** controls the sending and receiving of RIP packets. When set to **Both** or **Out Only**, the ZyWALL will broadcast its routing table periodically. When set to **Both** or **In Only**, it will incorporate the RIP information that it receives; when set to **None**, it will not send any RIP packets and will ignore any RIP packets received.

RIP Version controls the format and the broadcasting method of the RIP packets that the ZyWALL sends (it recognizes both formats when receiving). **RIP-1** is universally supported; but **RIP-2** carries more information. RIP-1 is probably adequate for most networks, unless you have an unusual network topology.

Both **RIP-2B** and **RIP-2M** send routing data in RIP-2 format; the difference being that **RIP-2B** uses subnet broadcasting while **RIP-2M** uses multicasting. Multicasting can reduce the load on non-router machines since they generally do not listen to the RIP multicast address and so will not receive the RIP packets. However, if one router uses multicasting, then all routers on your network must use multicasting, also.

By default, **RIP Direction** is set to **Both** and **RIP Version** to **RIP-1**.

4.3.4 Multicast

Traditionally, IP packets are transmitted in one of either two ways - Unicast (1 sender - 1 recipient) or Broadcast (1 sender - everybody on the network). Multicast delivers IP packets to a group of hosts on the network - not everybody and not just 1.

IGMP (Internet Group Multicast Protocol) is a network-layer protocol used to establish membership in a Multicast group - it is not used to carry user data. IGMP version 2 (RFC 2236) is an improvement over version 1 (RFC 1112) but IGMP version 1 is still in wide use. If you would like to read more detailed information about interoperability between IGMP version 2 and version 1, please see sections 4 and 5 of RFC 2236. The class D IP address is used to identify host groups and can be in the range 224.0.0.0 to 239.255.255.255. The address 224.0.0.0 is not assigned to any group and is used by IP multicast computers. The address 224.0.0.1 is used for query messages and is assigned to the permanent group of all IP hosts (including gateways). All hosts must join the 224.0.0.1 group in order to participate in IGMP. The address 224.0.0.2 is assigned to the multicast routers group.

The ZyWALL supports both IGMP version 1 (**IGMP-v1**) and IGMP version 2 (**IGMP-v2**). At start up, the ZyWALL queries all directly connected networks to gather group membership. After that, the ZyWALL periodically updates this information. IP multicasting can be enabled/disabled on the ZyWALL LAN and/or WAN interfaces in the web configurator (**LAN**; **WAN**). Select **None** to disable IP multicasting on these interfaces.

4.4 DNS Servers

Use the **DNS LAN** screen to configure the DNS server information that the ZyWALL sends to the DHCP client devices on the LAN.

4.5 Configuring LAN

Click **LAN** to open the **LAN** screen.

Figure 23 LAN

The following table describes the labels in this screen.

Table 18 LAN

LABEL	DESCRIPTION
LAN TCP/IP	
IP Address	Type the IP address of your ZyWALL in dotted decimal notation. 192.168.1.1 is the factory default. Alternatively, click the right mouse button to copy and/or paste the IP address.
IP Subnet Mask	The subnet mask specifies the network number portion of an IP address. Your ZyWALL automatically calculate the subnet mask based on the IP address that you assign. Unless you are implementing subnetting, use the subnet mask computed by the ZyWALL.
RIP Direction	RIP (Routing Information Protocol, RFC1058 and RFC 1389) allows a router to exchange routing information with other routers. The RIP Direction field controls the sending and receiving of RIP packets. Select the RIP direction from Both/In Only/Out Only/None . When set to Both or Out Only , the ZyWALL will broadcast its routing table periodically. When set to Both or In Only , it will incorporate the RIP information that it receives; when set to None , it will not send any RIP packets and will ignore any RIP packets received. Both is the default.

Table 18 LAN (continued)

LABEL	DESCRIPTION
RIP Version	The RIP Version field controls the format and the broadcasting method of the RIP packets that the ZyWALL sends (it recognizes both formats when receiving). RIP-1 is universally supported but RIP-2 carries more information. RIP-1 is probably adequate for most networks, unless you have an unusual network topology. Both RIP-2B and RIP-2M sends the routing data in RIP-2 format; the difference being that RIP-2B uses subnet broadcasting while RIP-2M uses multicasting. Multicasting can reduce the load on non-router machines since they generally do not listen to the RIP multicast address and so will not receive the RIP packets. However, if one router uses multicasting, then all routers on your network must use multicasting, also. By default, RIP direction is set to Both and the Version set to RIP-1 .
Multicast	Select IGMP V-1 or IGMP V-2 or None . IGMP (Internet Group Multicast Protocol) is a network-layer protocol used to establish membership in a Multicast group - it is not used to carry user data. IGMP version 2 (RFC 2236) is an improvement over version 1 (RFC 1112) but IGMP version 1 is still in wide use. If you would like to read more detailed information about interoperability between IGMP version 2 and version 1, please see <i>sections 4 and 5 of RFC 2236</i> .
DHCP Setup	
DHCP	DHCP (Dynamic Host Configuration Protocol, RFC 2131 and RFC 2132) allows individual clients (workstations) to obtain TCP/IP configuration at startup from a server. Unless you are instructed by your ISP, leave this field set to Server . When configured as a server, the ZyWALL provides TCP/IP configuration for the clients. When set as a server, fill in the IP Pool Starting Address and Pool Size fields. Select Relay to have the ZyWALL forward DHCP requests to another DHCP server. When set to Relay , fill in the DHCP Server Address field. Select None to stop the ZyWALL from acting as a DHCP server. When you select None , you must have another DHCP server on your LAN, or else the computers must be manually configured.
IP Pool Starting Address	This field specifies the first of the contiguous addresses in the IP address pool.
Pool Size	This field specifies the size, or count of the IP address pool.
DHCP Server Address	Type the IP address of the DHCP server to which you want the ZyWALL to relay DHCP requests. Use dotted decimal notation. Alternatively, click the right mouse button to copy and/or paste the IP address.
Windows Networking (NetBIOS over TCP/IP)	NetBIOS (Network Basic Input/Output System) are TCP or UDP packets that enable a computer to connect to and communicate with a LAN. For some dial-up services such as PPPoE or PPTP, NetBIOS packets cause unwanted calls. However it may sometimes be necessary to allow NetBIOS packets to pass through to the WAN in order to find a computer on the WAN.
Allow between LAN and WAN	Select this check box to forward NetBIOS packets from the LAN to the WAN and from the WAN to the LAN. If your firewall is enabled with the default policy set to block WAN to LAN traffic, you also need to enable the default WAN to LAN firewall rule that forwards NetBIOS traffic. Clear this check box to block all NetBIOS packets going from the LAN to the WAN and from the WAN to the LAN.
Allow between LAN and DMZ	Select this check box to forward NetBIOS packets from the LAN to the DMZ and from the DMZ to the LAN. (Not all ZyWALL models have a DMZ port.) If your firewall is enabled with the default policy set to block DMZ to LAN traffic, you also need to enable the default DMZ to LAN firewall rule that forwards NetBIOS traffic. Clear this check box to block all NetBIOS packets going from the LAN to the DMZ and from the DMZ to the LAN.

Table 18 LAN (continued)

LABEL	DESCRIPTION
Apply	Click Apply to save your changes back to the ZyWALL.
Reset	Click Reset to begin configuring this screen afresh.

4.6 Configuring Static DHCP

This table allows you to assign IP addresses on the LAN to specific individual computers based on their MAC Addresses.

Every Ethernet device has a unique MAC (Media Access Control) address. The MAC address is assigned at the factory and consists of six pairs of hexadecimal characters, for example, 00:A0:C5:00:00:02.

To change your ZyWALL's static DHCP settings, click **LAN**, then the **Static DHCP** tab. The screen appears as shown.

Figure 24 Static DHCP

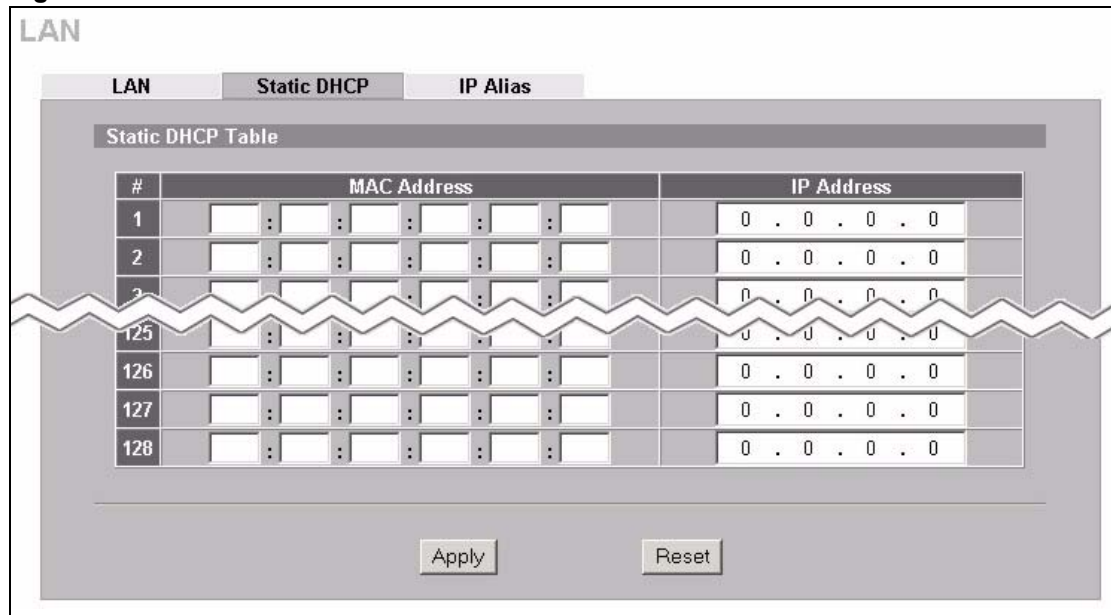

The following table describes the labels in this screen.

Table 19 Static DHCP

LABEL	DESCRIPTION
#	This is the index number of the Static IP table entry (row).
MAC Address	Type the MAC address (with colons) of a computer on your LAN.
IP Address	Type the IP address that you want to assign to the computer on your LAN. Alternatively, click the right mouse button to copy and/or paste the IP address.

Table 19 Static DHCP

LABEL	DESCRIPTION
Apply	Click Apply to save your changes back to the ZyWALL.
Reset	Click Reset to begin configuring this screen afresh.

4.7 Configuring IP Alias

IP alias allows you to partition a physical network into different logical networks over the same Ethernet interface. The ZyWALL supports three logical LAN interfaces via its single physical Ethernet interface with the ZyWALL itself as the gateway for each LAN network.

When you use IP alias, you can also configure firewall rules to control access between the LAN's logical networks (subnets).

Note: Make sure that the subnets of the logical networks do not overlap.

The following figure shows a LAN divided into subnets A, B, and C.

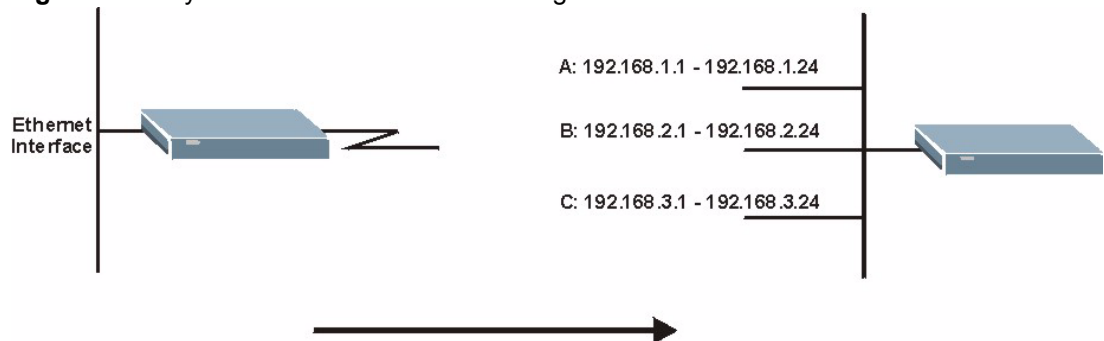
Figure 25 Physical Network & Partitioned Logical Networks

To change your ZyWALL's IP alias settings, click **LAN**, then the **IP Alias** tab. The screen appears as shown.

Figure 26 IP Alias

The screenshot shows the LAN configuration page with three tabs: LAN, Static DHCP, and IP Alias. The IP Alias tab is active. It displays two sections for IP Aliases. Each section has a header (IP Alias 1 and IP Alias 2), an 'Enable IP Alias' checkbox, and fields for IP Address, IP Subnet Mask, RIP Direction, and RIP Version. The IP Address and Subnet Mask fields are in dotted decimal notation. The RIP Direction and Version fields are dropdown menus. At the bottom, there are 'Apply' and 'Reset' buttons.

The following table describes the labels in this screen.

Table 20 IP Alias

LABEL	DESCRIPTION
Enable IP Alias 1, 2	Select the check box to configure another LAN network for the ZyWALL.
IP Address	Enter the IP address of your ZyWALL' in dotted decimal notation. Alternatively, click the right mouse button to copy and/or paste the IP address.
IP Subnet Mask	Your ZyWALL will automatically calculate the subnet mask based on the IP address that you assign. Unless you are implementing subnetting, use the subnet mask computed by the ZyWALL.
RIP Direction	RIP (Routing Information Protocol, RFC 1058 and RFC 1389) allows a router to exchange routing information with other routers. The RIP Direction field controls the sending and receiving of RIP packets. Select the RIP direction from Both/In Only/Out Only/None . When set to Both or Out Only , the ZyWALL will broadcast its routing table periodically. When set to Both or In Only , it will incorporate the RIP information that it receives; when set to None , it will not send any RIP packets and will ignore any RIP packets received.
RIP Version	The RIP Version field controls the format and the broadcasting method of the RIP packets that the ZyWALL sends (it recognizes both formats when receiving). RIP-1 is universally supported but RIP-2 carries more information. RIP-1 is probably adequate for most networks, unless you have an unusual network topology. Both RIP-2B and RIP-2M sends the routing data in RIP-2 format; the difference being that RIP-2B uses subnet broadcasting while RIP-2M uses multicasting. Multicasting can reduce the load on non-router machines since they generally do not listen to the RIP multicast address and so will not receive the RIP packets. However, if one router uses multicasting, then all routers on your network must use multicasting, also. By default, RIP direction is set to Both and the Version set to RIP-1 .

Table 20 IP Alias

LABEL	DESCRIPTION
Apply	Click Apply to save your changes back to the ZyWALL.
Reset	Click Reset to begin configuring this screen afresh.

CHAPTER 5

Bridge Screens

This chapter describes how to configure bridge settings. This chapter is only applicable when the ZyWALL is in bridge mode.

5.1 Bridge Loop

The ZyWALL can act as a bridge between a switch and a wired LAN or between two routers.

Be careful to avoid bridge loops when you enable bridging in the ZyWALL. Bridge loops cause broadcast traffic to circle the network endlessly, resulting in possible throughput degradation and disruption of communications. The following example shows the network topology that can lead to this problem:

- If your ZyWALL (in bridge mode) is connected to a wired LAN while communicating with another bridge or a switch that is also connected to the same wired LAN as shown next.

Figure 27 Bridge Loop: Bridge Connected to Wired LAN

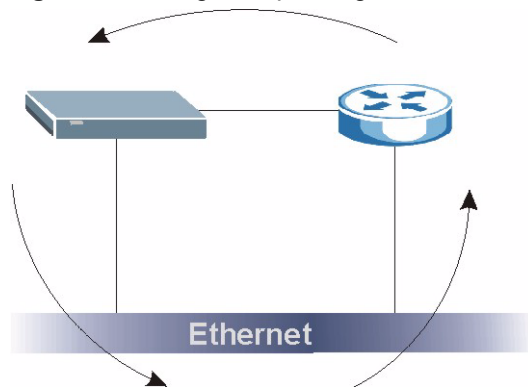

To prevent bridge loops, ensure that your ZyWALL is not set to bridge mode while connected to two wired segments of the same LAN or you enable RSTP in the **Bridge** screen.

5.2 Spanning Tree Protocol (STP)

STP detects and breaks network loops and provides backup links between switches, bridges or routers. It allows a bridge to interact with other STP-compliant bridges in your network to ensure that only one route exists between any two stations on the network.

5.2.1 Rapid STP

The ZyWALL uses IEEE 802.1w RSTP (Rapid Spanning Tree Protocol) that allow faster convergence of the spanning tree (while also being backwards compatible with STP-only aware bridges). Using RSTP topology change information does not have to propagate to the root bridge and unwanted learned addresses are flushed from the filtering database. In RSTP, the port states are Discarding, Learning, and Forwarding.

5.2.2 STP Terminology

The root bridge is the base of the spanning tree; it is the bridge with the lowest identifier value (MAC address).

Path cost is the cost of transmitting a frame from the root bridge to that port. It is assigned according to the speed of the link to which a port is attached. The slower the media, the higher the cost - see the next table.

Table 21 STP Path Costs

	LINK SPEED	RECOMMENDED VALUE	RECOMMENDED RANGE	ALLOWED RANGE
Path Cost	4Mbps	250	100 to 1000	1 to 65535
Path Cost	10Mbps	100	50 to 600	1 to 65535
Path Cost	16Mbps	62	40 to 400	1 to 65535
Path Cost	100Mbps	19	10 to 60	1 to 65535
Path Cost	1Gbps	4	3 to 10	1 to 65535
Path Cost	10Gbps	2	1 to 5	1 to 65535

On each bridge, the root port is the port through which this bridge communicates with the root. It is the port on this switch with the lowest path cost to the root (the root path cost). If there is no root port, then this bridge has been accepted as the root bridge of the spanning tree network.

For each LAN segment, a designated bridge is selected. This bridge has the lowest cost to the root among the bridges connected to the LAN.

5.2.3 How STP Works

After a bridge determines the lowest cost-spanning tree with STP, it enables the root port and the ports that are the designated ports for connected LANs, and disables all other ports that participate in STP. Network packets are therefore only forwarded between enabled ports, eliminating any possible network loops.

STP-aware bridges exchange Bridge Protocol Data Units (BPDUs) periodically. When the bridged LAN topology changes, a new spanning tree is constructed.

Once a stable network topology has been established, all bridges listen for Hello BPDUs (Bridge Protocol Data Units) transmitted from the root bridge. If a bridge does not get a Hello BPDU after a predefined interval (Max Age), the bridge assumes that the link to the root bridge is down. This bridge then initiates negotiations with other bridges to reconfigure the network to re-establish a valid network topology.

5.2.4 STP Port States

STP assigns five port states (see next table) to eliminate packet looping. A bridge port is not allowed to go directly from blocking state to forwarding state so as to eliminate transient loops.

Table 22 STP Port States

PORT STATE	DESCRIPTION
Disabled	STP is disabled (default).
Blocking	Only configuration and management BPDUs are received and processed.
Listening	All BPDUs are received and processed.
Learning	All BPDUs are received and processed. Information frames are submitted to the learning process but not forwarded.
Forwarding	All BPDUs are received and processed. All information frames are received and forwarded.

5.3 Configuring Bridge

Select **Bridge** and click **Apply** in the **MAINTENANCE Device Mode** screen to have the ZyWALL function as a bridge.

To change your ZyWALL's bridge settings, click **BRIDGE**. The screen appears as shown.

Figure 28 Bridge

BRIDGE

Bridge

Bridge Setup

IP Address: 172 . 22 . 2 . 224
 IP Subnet Mask: 255 . 255 . 0 . 0
 Gateway IP Address: 172 . 22 . 0 . 254

First DNS Server: 0 . 0 . 0 . 0
 Second DNS Server: 0 . 0 . 0 . 0
 Third DNS Server: 0 . 0 . 0 . 0

Rapid Spanning Tree Protocol Setup

Enable Rapid Spanning Tree Protocol

Bridge Priority: 32768 (0(Highest)~ 61440(Lowest))
 Bridge Hello Time: 2 (1(Second)~ 10(Seconds))
 Bridge Max Age: 20 (6(Seconds)~ 40(Seconds))
 Forward Delay: 15 (4(Seconds)~ 30(Seconds))

Bridge Port	RSTP Active	RSTP Priority 0(Highest)~240(Lowest)	RSTP Path Cost 1(Lowest)~65535(Highest)
WAN1	<input type="checkbox"/>	128	250
WAN2	<input type="checkbox"/>	128	250
LAN	<input type="checkbox"/>	128	250
WLAN	<input type="checkbox"/>	128	250
DMZ	<input type="checkbox"/>	128	250

Apply Reset

The following table describes the labels in this screen.

Table 23 Bridge

LABEL	DESCRIPTION
Bridge IP Address Setup	
IP Address	Type the IP address of your ZyWALL in dotted decimal notation.
IP Subnet Mask	The subnet mask specifies the network number portion of an IP address.
Gateway IP Address	Enter the gateway IP address.
First/Second/Third DNS Server	DNS (Domain Name System) is for mapping a domain name to its corresponding IP address and vice versa. The DNS server is extremely important because without it, you must know the IP address of a machine before you can access it. The ZyWALL uses a system DNS server (in the order you specify here) to resolve domain names for content filtering, the time server, etc. If you have the IP address(es) of the DNS server(s), enter the DNS server's IP address(es) in the field(s) to the right.

Table 23 Bridge (continued)

LABEL	DESCRIPTION
Rapid Spanning Tree Protocol Setup	
Enable Rapid Spanning Tree Protocol	Select the check box to activate RSTP on the ZyWALL.
Bridge Priority	Enter a number between 0 and 61440 as bridge priority of the ZyWALL. 0 is the highest.
Bridge Hello Time	Enter an interval (between 1 and 10) in seconds that the root bridge waits before sending a hello packet.
Bridge Max Age	Enter an interval (between 6 and 40) in seconds that a bridge waits to get a Hello BPDU from the root bridge.
Forward Delay	Enter the length of time (between 4 and 30) in seconds that a bridge remains in the listening and learning port states. The default is 15 seconds.
Bridge Port	This is the bridge port type. Port types are: WAN, LAN, WLAN and DMZ.
RSTP Active	Select the check box to enable RSTP on the corresponding port.
RSTP Priority 0(Highest)~240(Lowest)	Enter a number between 0 and 240 as RSTP priority for the corresponding port. 0 is the highest.
RSTP Path Cost 1(Lowest)~65535(Highest)	Enter a number between 1 and 65535 as RSTP path cost for the corresponding port. 65535 is the highest.
Apply	Click Apply to save your changes back to the ZyWALL.
Reset	Click Reset to begin configuring this screen afresh.

CHAPTER 6

Wireless LAN

This chapter discusses how to configure wireless LAN on the ZyWALL.

6.1 Introduction

A wireless LAN can be as simple as two computers with wireless LAN adapters communicating in a peer-to-peer network or as complex as a number of computers with wireless LAN adapters communicating through access points which bridge network traffic to the wired LAN.

Note: See the Hardware Specifications appendix for how to install a WLAN card.

See the WLAN appendix for more detailed information on WLANs.

6.1.1 Additional Installation Requirements for Using 802.1x

- A computer with an IEEE 802.11b wireless LAN card.
- A computer equipped with a web browser (with JavaScript enabled) and/or Telnet.
- A wireless station must be running IEEE 802.1x-compliant software. Currently, this is offered in Windows XP.
- An optional network RADIUS server for remote user authentication and accounting.

6.2 Wireless Security

Wireless security is vital to your network to protect wireless communication between wireless stations, access points and other wireless.

The figure below shows the possible wireless security levels on your ZyWALL. EAP (Extensible Authentication Protocol) is used for authentication and utilizes dynamic WEP key exchange. It requires interaction with a RADIUS (Remote Authentication Dial-In User Service) server either on the WAN or your LAN to provide authentication service for wireless stations.

Figure 29 ZyWALL Wireless Security Levels

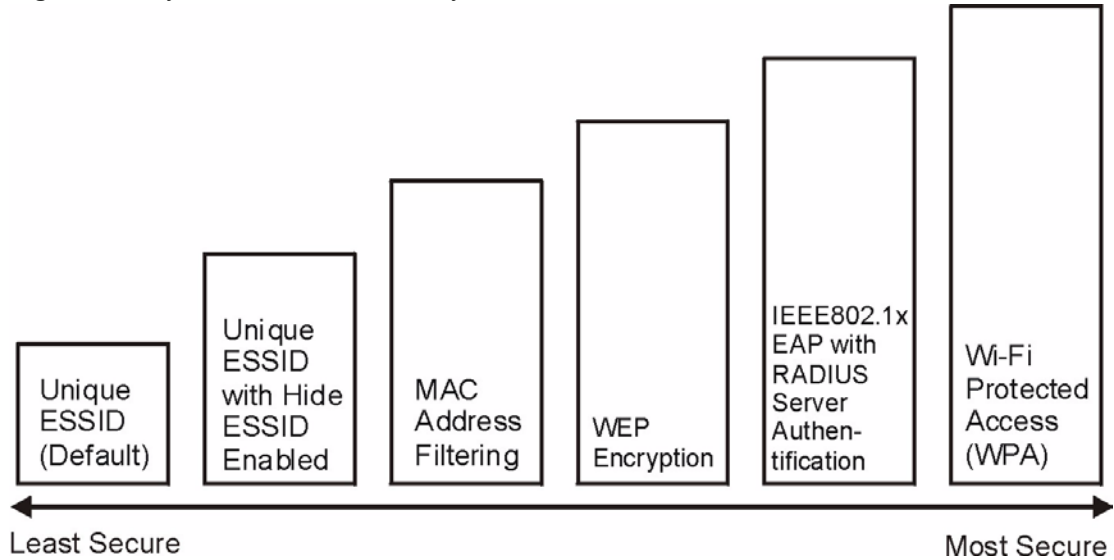

If you do not enable any wireless security on your ZyWALL, your network is accessible to any wireless networking device that is within range.

Use the ZyWALL web configurator to set up your wireless LAN security settings. Refer to the chapter on using the ZyWALL web configurator to see how to access the web configurator.

6.3 Security Parameters Summary

Refer to this table to see what other security parameters you should configure for each Authentication Method/ key management protocol type. You enter manual keys by first selecting **64-bit WEP** or **128-bit WEP** from the **WEP Encryption** field and then typing the keys (in ASCII or hexadecimal format) in the key text boxes. MAC address filters are not dependent on how you configure these security features.

Table 24 Wireless Security Relational Matrix

AUTHENTICATION METHOD/ KEY MANAGEMENT PROTOCOL	ENCRYPTION METHOD	ENTER MANUAL KEY	IEEE 802.1X
Open	None	No	Disable
Open	WEP	No	Enable with Dynamic WEP Key
		Yes	Enable without Dynamic WEP Key
		Yes	Disable
Shared	WEP	No	Enable with Dynamic WEP Key
		Yes	Enable without Dynamic WEP Key
		Yes	Disable
WPA	WEP	No	Enable
WPA	TKIP	No	Enable

Table 24 Wireless Security Relational Matrix (continued)

AUTHENTICATION METHOD/ KEY MANAGEMENT PROTOCOL	ENCRYPTION METHOD	ENTER MANUAL KEY	IEEE 802.1X
WPA-PSK	WEP	Yes	Enable
WPA-PSK	TKIP	Yes	Enable

6.4 WEP Encryption

WEP (Wired Equivalent Privacy) as specified in the IEEE 802.11 standard provides methods for both data encryption and wireless station authentication. WEP provides a mechanism for encrypting data using encryption keys. Both the AP and the wireless stations must use the same WEP key to encrypt and decrypt data. Your ZyWALL allows you to configure up to four 64-bit or 128-bit WEP keys, but only one key can be used at any one time.

6.5 802.1x Overview

The IEEE 802.1x standard outlines enhanced security methods for both the authentication of wireless stations and encryption key management. Authentication can be done using the local user database internal to the ZyWALL (authenticate up to 32 users) or an external RADIUS server for an unlimited number of users.

6.6 Dynamic WEP Key Exchange

The AP maps a unique key that is generated with the RADIUS server. This key expires when the wireless connection times out, disconnects or reauthentication times out. A new WEP key is generated each time reauthentication is performed.

If this feature is enabled, it is not necessary to configure a default encryption key in the **Wireless** screen. You may still configure and store keys here, but they will not be used while dynamic WEP is enabled.

To use dynamic WEP, enable and configure dynamic WEP key exchange in the **Wireless** screen (see [Section 6.12.4 on page 121](#)) and configure RADIUS server settings in the **AUTH SERVER RADIUS** screen (see [Section 16.3 on page 295](#)). Ensure that the wireless station's EAP type is configured to one of the following:

- EAP-TLS
- EAP-TTLS
- PEAP

Note: EAP-MD5 cannot be used with dynamic WEP key exchange.

6.7 Introduction to WPA

Wi-Fi Protected Access (WPA) is a subset of the IEEE 802.11i security specification draft. Key differences between WPA and WEP are user authentication and improved data encryption.

6.7.1 User Authentication

WPA applies IEEE 802.1x and Extensible Authentication Protocol (EAP) to authenticate wireless clients using an external RADIUS database. You can't use the ZyWALL's Local User Database for WPA authentication purposes since the Local User Database uses EAP-MD5 which cannot be used to generate keys. See later in this chapter and the appendices for more information on IEEE 802.1x, RADIUS and EAP.

Therefore, if you don't have an external RADIUS server you should use WPA-PSK (WPA - Pre-Shared Key) that only requires a single (identical) password entered into each access point, wireless gateway and wireless client. As long as the passwords match, a client will be granted access to a WLAN.

6.7.2 Encryption

WPA improves data encryption by using Temporal Key Integrity Protocol (TKIP), Message Integrity Check (MIC) and IEEE 802.1x.

Temporal Key Integrity Protocol (TKIP) uses 128-bit keys that are dynamically generated and distributed by the authentication server. It includes a per-packet key mixing function, a Message Integrity Check (MIC) named Michael, an extended initialization vector (IV) with sequencing rules, and a re-keying mechanism.

TKIP regularly changes and rotates the encryption keys so that the same encryption key is never used twice. The RADIUS server distributes a Pairwise Master Key (PMK) key to the AP that then sets up a key hierarchy and management system, using the pair-wise key to dynamically generate unique data encryption keys to encrypt every data packet that is wirelessly communicated between the AP and the wireless clients. This all happens in the background automatically.

The Message Integrity Check (MIC) is designed to prevent an attacker from capturing data packets, altering them and resending them. The MIC provides a strong mathematical function in which the receiver and the transmitter each compute and then compare the MIC. If they do not match, it is assumed that the data has been tampered with and the packet is dropped.

By generating unique data encryption keys for every data packet and by creating an integrity checking mechanism (MIC), TKIP makes it much more difficult to decode data on a Wi-Fi network than WEP, making it difficult for an intruder to break into the network.

The encryption mechanisms used for WPA and WPA-PSK are the same. The only difference between the two is that WPA-PSK uses a simple common password, instead of user-specific credentials. The common-password approach makes WPA-PSK susceptible to brute-force password-guessing attacks but it's still an improvement over WEP as it employs an easier-to-use, consistent, single, alphanumeric password.

6.8 WPA-PSK Application Example

A WPA-PSK application looks as follows.

- 1 First enter identical passwords into the AP and all wireless clients. The Pre-Shared Key (PSK) must consist of between 8 and 63 ASCII characters (including spaces and symbols).
- 2 The AP checks each client's password and (only) allows it to join the network if it matches its password.
- 3 The AP derives and distributes keys to the wireless clients.
- 4 The AP and wireless clients use the TKIP encryption process to encrypt data exchanged between them.

Figure 30 WPA-PSK Authentication

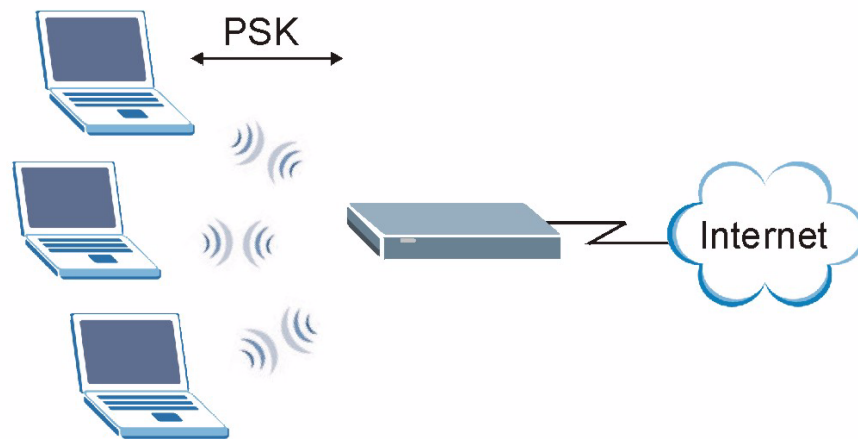

6.9 Introduction to RADIUS

The ZyWALL can use an external RADIUS server to authenticate an unlimited number of users. RADIUS is based on a client-server model that supports authentication and accounting, where access point is the client and the server is the RADIUS server.

- Authentication
Determines the identity of the users.
- Accounting

Keeps track of the client's network activity.

RADIUS user is a simple package exchange in which your ZyWALL acts as a message relay between the wireless station and the network RADIUS server.

6.10 WPA with RADIUS Application Example

You need the IP address of the RADIUS server, its port number (default is 1812), and the RADIUS shared secret. A WPA application example with an external RADIUS server looks as follows. "A" is the RADIUS server. "DS" is the distribution system.

- 1 The AP passes the wireless client's authentication request to the RADIUS server.
- 2 The RADIUS server then checks the user's identification against its database and grants or denies network access accordingly.
- 3 The RADIUS server distributes a Pairwise Master Key (PMK) key to the AP that then sets up a key hierarchy and management system, using the pair-wise key to dynamically generate unique data encryption keys to encrypt every data packet that is wirelessly communicated between the AP and the wireless clients.

Figure 31 WPA with RADIUS Application Example

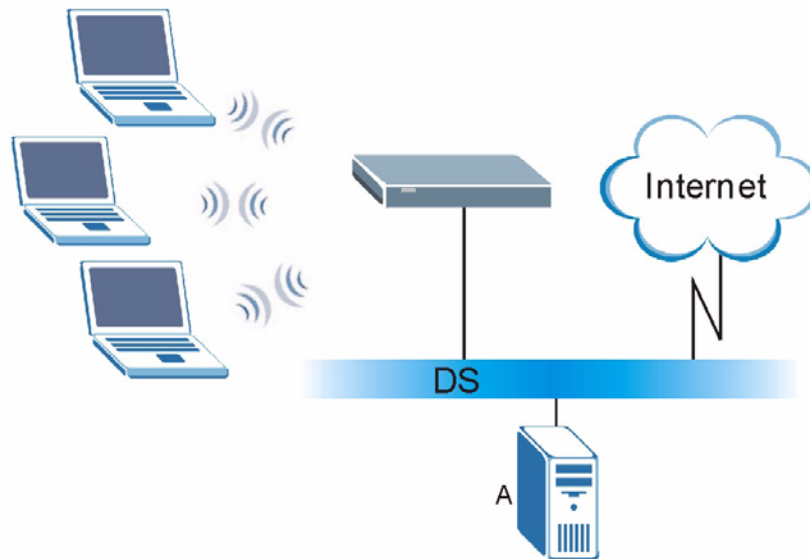

6.11 Wireless Client WPA Supplicants

A wireless client supplicant is the software that runs on an operating system instructing the wireless client how to use WPA. At the time of writing, the most widely available supplicants are the WPA patch for Windows XP, Funk Software's Odyssey client, and Meetinghouse Data Communications' AEGIS client.

The Windows XP patch is a free download that adds WPA capability to Windows XP's built-in "Zero Configuration" wireless client. However, you must run Windows XP to use it.

6.12 Configuring Wireless LAN

Note: If you are configuring the ZyWALL from a computer connected to the wireless LAN and you change the ZyWALL's ESSID or WEP settings, you will lose your wireless connection when you press **Apply** to confirm. You must then change the wireless settings of your computer to match the ZyWALL's new settings.

Click **WIRELESS LAN** to open the **Wireless** screen. The screen varies according to the security features you select.

Figure 32 Wireless: No Security

The screenshot displays the 'WIRELESS LAN' configuration interface. At the top, there are two tabs: 'Wireless' (selected) and 'MAC Filter'. Below the tabs is a 'General Setup' section. The 'Enable Wireless LAN' checkbox is unchecked. The 'Wireless Card' status is 'Not Installed', with a red error message: 'Your device must have a wireless card installed to use the wireless LAN feature.' The 'ESSID' field contains 'ZyXEL'. The 'Hide ESSID' checkbox is unchecked. The 'Channel ID' is set to 'Channel-06 2437MHz'. The 'RTS/CTS' checkbox is unchecked, and its 'Threshold' is set to '2432' (range 0 ~ 2432). The 'Fragmentation' checkbox is unchecked, and its 'Threshold' is set to '2432' (range 256 ~ 2432). The 'Security' dropdown menu is set to 'No Security'. At the bottom, there are 'Apply' and 'Reset' buttons.

The following table describes the labels in this screen.

Table 25 Wireless: No Security

LABEL	DESCRIPTION
Enable Wireless LAN	The wireless LAN is turned off by default, before you enable the wireless LAN you should configure some security by setting MAC filters and/or 802.1x security; otherwise your wireless LAN will be vulnerable upon enabling it. Select the check box to enable the wireless LAN.
Wireless Card	This field displays whether or not a compatible ZyXEL wireless LAN card is installed. You can only use the wireless LAN feature if a compatible ZyXEL wireless LAN card is installed. Note: Turn the ZyWALL off before you install or remove the wireless LAN card. See the product specifications appendix for a table of compatible ZyXEL WLAN cards (and the WLAN security features each card supports) and how to install a WLAN card.
ESSID	(Extended Service Set IDentity) The ESSID identifies the Service Set with which a wireless station is associated. Wireless stations associating to the access point (AP) must have the same ESSID. Enter a descriptive name (up to 32 printable 7-bit ASCII characters) for the wireless LAN.
Hide ESSID	Select to hide the ESSID in the outgoing beacon frame so a station cannot obtain the ESSID through passive scanning.
Channel ID	This allows you to set the operating frequency/channel depending on your particular region. Select a channel from the drop-down list box.
RTS/CTS Threshold	The RTS (Request To Send) threshold (number of bytes) is for enabling RTS/CTS. Data with its frame size larger than this value will perform the RTS/CTS handshake. Setting this value to be larger than the maximum MSDU (MAC service data unit) size turns off RTS/CTS. Setting this value to zero turns on RTS/CTS. Select the check box to change the default value and enter a new value between 0 and 2432 .
Fragmentation Threshold	This is the threshold (number of bytes) for the fragmentation boundary for directed messages. It is the maximum data fragment size that can be sent. Select the check box to change the default value and enter a value between 256 and 2432 .

Table 25 Wireless: No Security (continued)

LABEL	DESCRIPTION
Security	<p>Choose from one of the security settings listed in the drop-down box.</p> <ul style="list-style-type: none"> • No Security • Static WEP • WPA-PSK • WPA • 802.1x + Dynamic WEP • 802.1x + Static WEP • 802.1x + No WEP • No Access 802.1x + Static WEP • No Access 802.1x + No WEP <p>Select No Security to allow wireless stations to communicate with the access points without any data encryption. Otherwise, select the security you need and see the following sections for more information.</p> <p>Note: The installed ZyXEL WLAN card may not support all of the WLAN security features you can configure in the ZyWALL.</p> <p>Please see the product specifications appendix for a table of compatible ZyXEL WLAN cards and the WLAN security features each card supports.</p>
Apply	Click Apply to save your changes back to the ZyWALL.
Reset	Click Reset to begin configuring this screen afresh.

6.12.1 Static WEP

Static WEP provides a mechanism for encrypting data using encryption keys. Both the AP and the wireless stations must use the same WEP key to encrypt and decrypt data. Your ZyWALL allows you to configure up to four 64-bit or 128-bit WEP keys, but only one key can be used at any one time.

In order to configure and enable WEP encryption, click the **WIRELESS LAN** link to display the **Wireless** screen. Select **Static WEP** from the **Security** list.

Figure 33 Wireless: Static WEP

The following table describes the wireless LAN security labels in this screen.

Table 26 Wireless: Static WEP

LABEL	DESCRIPTION
Security	Select Static WEP from the drop-down list.
WEP Encryption	WEP (Wired Equivalent Privacy) provides data encryption to prevent unauthorized wireless stations from accessing data transmitted over the wireless network. Select 64-bit WEP or 128-bit WEP to enable data encryption.
Key 1 to Key 4	If you chose 64-bit WEP in the WEP Encryption field, then enter any 5 characters (ASCII string) or 10 hexadecimal characters ("0-9", "A-F") preceded by 0x for each key. If you chose 128-bit WEP in the WEP Encryption field, then enter 13 characters (ASCII string) or 26 hexadecimal characters ("0-9", "A-F") preceded by 0x for each key. There are four data encryption keys to secure your data from eavesdropping by unauthorized wireless users. The values for the keys must be set up exactly the same on the access points as they are on the wireless stations.
Apply	Click Apply to save your changes back to the ZyWALL.
Reset	Click Reset to begin configuring this screen afresh.

6.12.2 WPA-PSK

Select **WPA-PSK** from the **Security** list.

Figure 34 Wireless: WPA-PSK

The screenshot shows the 'WIRELESS LAN' configuration page with the 'Wireless' tab selected. Under 'General Setup', the 'Enable Wireless LAN' checkbox is unchecked. A red message states: 'Not Installed. Your device must have a wireless card installed to use the wireless LAN feature.' The ESSID is 'ZyXEL'. The 'Security' dropdown is set to 'WPA-PSK'. Other settings include 'Pre-Shared Key' (empty), 'ReAuthentication Timer' (1800), 'Idle Timeout' (3600), and 'WPA Group Key Update Timer' (1800). 'Apply' and 'Reset' buttons are at the bottom.

The following wireless LAN security fields become available when you select **WPA-PSK** in the **Security** drop down list-box.

Table 27 Wireless: WPA-PSK

LABEL	DESCRIPTION
Security	Select WPA-PSK from the drop-down list.
Pre-Shared Key	The encryption mechanisms used for WPA and WPA-PSK are the same. The only difference between the two is that WPA-PSK uses a simple common password, instead of user-specific credentials. Type a pre-shared key from 8 to 63 case-sensitive ASCII characters (including spaces and symbols).
ReAuthentication Timer (Seconds)	Specify how often wireless stations have to reenter user names and passwords in order to stay connected. Enter a time interval between 10 and 9999 seconds. If wireless station authentication is done using a RADIUS server, the reauthentication timer on the RADIUS server has priority.
Idle Timeout (Seconds)	The ZyWALL automatically disconnects a wireless station from the wired network after a period of inactivity. The wireless station needs to enter the user name and password again before access to the wired network is allowed.

Table 27 Wireless: WPA-PSK (continued)

LABEL	DESCRIPTION
WPA Group Key Update Timer (Seconds)	The WPA Group Key Update Timer is the rate at which the AP (if using WPA-PSK key management) or RADIUS server (if using WPA key management) sends a new group key out to all clients. The re-keying process is the WPA equivalent of automatically changing the WEP key for an AP and all stations in a WLAN on a periodic basis. Setting of the WPA Group Key Update Timer is also supported in WPA-PSK mode.
Apply	Click Apply to save your changes back to the ZyWALL.
Reset	Click Reset to begin configuring this screen afresh.

6.12.3 WPA

Select **WPA** from the **Security** list.

Figure 35 Wireless: WPA

The screenshot shows the 'WIRELESS LAN' configuration page with the 'Wireless' tab selected. Under 'General Setup', the 'Enable Wireless LAN' checkbox is unchecked. A message states 'Wireless Card Not Installed' and 'Your device must have a wireless card installed to use the wireless LAN feature.' The ESSID is set to 'ZyXEL'. The 'Channel ID' is set to 'Channel-06 2437MHz'. Both 'RTS/CTS' and 'Fragmentation' checkboxes are unchecked, with their respective 'Threshold' values set to 2432. Under 'Security', the mode is set to 'WPA'. The 'ReAuthentication Timer' is 1800 seconds, 'Idle Timeout' is 3600 seconds, and 'Authentication Databases' is set to 'RADIUS'. The 'WPA Group Key Update Timer' is 1800 seconds. 'Apply' and 'Reset' buttons are at the bottom.

The following wireless LAN security fields become available when you select **WPA** in the **Security** drop down list-box.

Table 28 Wireless: WPA

LABEL	DESCRIPTION
Security	Select WPA from the drop-down list.
ReAuthentication Timer (Seconds)	Specify how often wireless stations have to reenter user names and passwords in order to stay connected. Enter a time interval between 10 and 9999 seconds. If wireless station authentication is done using a RADIUS server, the reauthentication timer on the RADIUS server has priority.
Idle Timeout (Seconds)	The ZyWALL automatically disconnects a wireless station from the wired network after a period of inactivity. The wireless station needs to enter the user name and password again before access to the wired network is allowed.
Authentication Databases	Click RADIUS to go to the RADIUS screen where you can configure the ZyWALL to check an external RADIUS server.
WPA Group Key Update Timer (Seconds)	The WPA Group Key Update Timer is the rate at which the AP (if using WPA-PSK key management) or RADIUS server (if using WPA key management) sends a new group key out to all clients. The re-keying process is the WPA equivalent of automatically changing the WEP key for an AP and all stations in a WLAN on a periodic basis. Setting of the WPA Group Key Update Timer is also supported in WPA-PSK mode.
Apply	Click Apply to save your changes back to the ZyWALL.
Reset	Click Reset to begin configuring this screen afresh.

6.12.4 802.1x + Dynamic WEP

Select **802.1x + Dynamic WEP** from the **Security** list.

Figure 36 Wireless: 802.1x + Dynamic WEP

The screenshot shows the 'WIRELESS LAN' configuration page. At the top, there are two tabs: 'Wireless' and 'MAC Filter'. Below them is a 'General Setup' section. The 'Enable Wireless LAN' checkbox is unchecked. A red message indicates that a wireless card is not installed. The ESSID is 'ZyXEL'. The 'Channel ID' is 'Channel-06 2437MHz'. The 'RTS/CTS' and 'Fragmentation' checkboxes are unchecked, with their respective thresholds set to 2432. The 'Security' dropdown is set to '802.1x + Dynamic WEP'. The 'ReAuthentication Timer' is 1800 seconds, and the 'Idle Timeout' is 3600 seconds. The 'Authentication Databases' are set to 'Local User first then RADIUS'. The 'Dynamic WEP Key Exchange' is set to '64-bit'. At the bottom, there are 'Apply' and 'Reset' buttons.

The following wireless LAN security fields become available when you select **802.1x + Dynamic WEP** in the **Security** drop down list-box.

Table 29 Wireless: 802.1x + Dynamic WEP

LABEL	DESCRIPTION
Security	Select 802.1x + Dynamic WEP from the drop-down list.
ReAuthentication Timer (Seconds)	Specify how often wireless stations have to reenter user names and passwords in order to stay connected. Enter a time interval between 10 and 9999 seconds. If wireless station authentication is done using a RADIUS server, the reauthentication timer on the RADIUS server has priority.
Idle Timeout (Seconds)	The ZyWALL automatically disconnects a wireless station from the wired network after a period of inactivity. The wireless station needs to enter the user name and password again before access to the wired network is allowed.
Authentication Databases	Click Local User to go to the Local User Database screen where you can view and/or edit the list of users and passwords. Click RADIUS to go to the RADIUS screen where you can configure the ZyWALL to check an external RADIUS server.
Dynamic WEP Key Exchange	Select 64-bit WEP or 128-bit WEP to enable data encryption. Up to 32 stations can access the ZyWALL when you configure dynamic WEP key exchange.
Apply	Click Apply to save your changes back to the ZyWALL.
Reset	Click Reset to begin configuring this screen afresh.

6.12.5 802.1x + Static WEP

Select **802.1x + Static WEP** from the **Security** list.

Figure 37 Wireless: 802.1x + Static WEP

The screenshot shows the 'WIRELESS LAN' configuration page with the 'Wireless' tab selected. Under 'General Setup', the 'Enable Wireless LAN' checkbox is unchecked. A red message states: 'Your device must have a wireless card installed to use the wireless LAN feature.' The 'Wireless Card' is listed as 'Not Installed'. The 'ESSID' is 'ZyXEL'. The 'Channel ID' is 'Channel-06 2437MHz'. The 'RTS/CTS' and 'Fragmentation' checkboxes are unchecked, with their respective 'Threshold' values set to 2432. The 'Security' dropdown is set to '802.1x + Static WEP' and 'WEP Encryption' is set to '64-bit WEP'. Below this, four keys are listed, each with a value of '0x0000000000'. The 'ReAuthentication Timer' is 1800 seconds and the 'Idle Timeout' is 3600 seconds. The 'Authentication Databases' are set to 'Local User first then RADIUS'. 'Apply' and 'Reset' buttons are at the bottom.

The following wireless LAN security fields become available when you select **802.1x + Static WEP** in the **Security** drop down list-box.

Table 30 Wireless: 802.1x + Static WEP

LABEL	DESCRIPTION
Security	Select 802.1x + Static WEP from the drop-down list.
WEP Encryption	WEP (Wired Equivalent Privacy) provides data encryption to prevent unauthorized wireless stations from accessing data transmitted over the wireless network. Select 64-bit WEP or 128-bit WEP to enable data encryption.

Table 30 Wireless: 802.1x + Static WEP (continued)

LABEL	DESCRIPTION
Key 1 to Key 4	<p>If you chose 64-bit WEP in the WEP Encryption field, then enter any 5 characters (ASCII string) or 10 hexadecimal characters ("0-9", "A-F") preceded by 0x for each key.</p> <p>If you chose 128-bit WEP in the WEP Encryption field, then enter 13 characters (ASCII string) or 26 hexadecimal characters ("0-9", "A-F") preceded by 0x for each key.</p> <p>There are four data encryption keys to secure your data from eavesdropping by unauthorized wireless users. The values for the keys must be set up exactly the same on the access points as they are on the wireless stations.</p>
ReAuthentication Timer (Seconds)	<p>Specify how often wireless stations have to reenter user names and passwords in order to stay connected. Enter a time interval between 10 and 9999 seconds.</p> <p>If wireless station authentication is done using a RADIUS server, the reauthentication timer on the RADIUS server has priority.</p>
Idle Timeout (Seconds)	<p>The ZyWALL automatically disconnects a wireless station from the wired network after a period of inactivity. The wireless station needs to enter the user name and password again before access to the wired network is allowed.</p>
Authentication Databases	<p>Click Local User to go to the Local User Database screen where you can view and/or edit the list of users and passwords. Click RADIUS to go to the RADIUS screen where you can configure the ZyWALL to check an external RADIUS server.</p>
Apply	<p>Click Apply to save your changes back to the ZyWALL.</p>
Reset	<p>Click Reset to begin configuring this screen afresh.</p>

6.12.6 802.1x + No WEP

Select **802.1x + No WEP** from the **Security** list.

Figure 38 Wireless: 802.1x + No WEP

The following wireless LAN security fields become available when you select **802.1x + No WEP** in the **Security** drop down list-box.

Table 31 Wireless: 802.1x + No WEP

LABEL	DESCRIPTION
Security	Select 802.1x + No WEP from the drop-down list.
ReAuthentication Timer (Seconds)	Specify how often wireless stations have to reenter user names and passwords in order to stay connected. Enter a time interval between 10 and 9999 seconds. If wireless station authentication is done using a RADIUS server, the reauthentication timer on the RADIUS server has priority.
Idle Timeout (Seconds)	The ZyWALL automatically disconnects a wireless station from the wired network after a period of inactivity. The wireless station needs to enter the user name and password again before access to the wired network is allowed.
Authentication Databases	Click Local User to go to the Local User Database screen where you can view and/or edit the list of users and passwords. Click RADIUS to go to the RADIUS screen where you can configure the ZyWALL to check an external RADIUS server.
Apply	Click Apply to save your changes back to the ZyWALL.
Reset	Click Reset to begin configuring this screen afresh.

6.12.7 No Access 802.1x + Static WEP

Select **No Access 802.1x + Static WEP** to deny all wireless stations access to your wired network and allow wireless stations to communicate with the ZyWALL using static WEP keys for data encryption.

Figure 39 Wireless: No Access 802.1x + Static WEP

The screenshot shows the 'WIRELESS LAN' configuration page with the 'MAC Filter' tab selected. Under 'General Setup', the 'Enable Wireless LAN' checkbox is unchecked. A red message states: 'Your device must have a wireless card installed to use the wireless LAN feature.' The ESSID is 'ZyXEL'. The Channel ID is 'Channel-06 2437MHz'. The RTS/CTS and Fragmentation thresholds are both set to 2432. In the 'Security' section, the dropdown menu is set to 'No Access 802.1x + Static WEP'. The 'WEP Encryption' dropdown is set to '64-bit WEP'. Below this, four WEP keys are listed, each with a radio button and a text input field containing '0x0000000000'. At the bottom are 'Apply' and 'Reset' buttons.

The following wireless LAN security fields become available when you select **No Access 802.1x + Static WEP** in the **Security** drop down list-box.

Table 32 Wireless: No Access 802.1x + Static WEP

LABEL	DESCRIPTION
Security	Select No Access 802.1x + Static WEP from the drop-down list.
WEP Encryption	WEP (Wired Equivalent Privacy) provides data encryption to prevent unauthorized wireless stations from accessing data transmitted over the wireless network. Select 64-bit WEP or 128-bit WEP to enable data encryption.

Table 32 Wireless: No Access 802.1x + Static WEP (continued)

LABEL	DESCRIPTION
Key 1 to Key 4	<p>If you chose 64-bit WEP in the WEP Encryption field, then enter any 5 characters (ASCII string) or 10 hexadecimal characters ("0-9", "A-F") preceded by 0x for each key.</p> <p>If you chose 128-bit WEP in the WEP Encryption field, then enter 13 characters (ASCII string) or 26 hexadecimal characters ("0-9", "A-F") preceded by 0x for each key.</p> <p>There are four data encryption keys to secure your data from eavesdropping by unauthorized wireless users. The values for the keys must be set up exactly the same on the access points as they are on the wireless stations.</p>
Apply	Click Apply to save your changes back to the ZyWALL.
Reset	Click Reset to begin configuring this screen afresh.

6.12.8 No Access 802.1x + No WEP

Select **No Access 802.1x + No WEP** to deny all wireless stations access to your wired network and block all wireless stations from communicating with the ZyWALL.

6.13 Configuring MAC Filter

The MAC filter screen allows you to configure the ZyWALL to give exclusive access to specific devices (**Allow Association**) or exclude specific devices from accessing the ZyWALL (**Deny Association**). Every Ethernet device has a unique MAC (Media Access Control) address. The MAC address is assigned at the factory and consists of six pairs of hexadecimal characters, for example, 00:A0:C5:00:00:02. You need to know the MAC addresses of the devices to configure this screen.

To change your ZyWALL's MAC filter settings, click **WIRELESS LAN**, then the **MAC Filter** tab. The screen appears as shown.

Figure 40 MAC Address Filter

The following table describes the labels in this menu.

Table 33 MAC Address Filter

LABEL	DESCRIPTION
Active	Select or clear the check box to enable or disable MAC address filtering. Enable MAC address filtering to have the router allow or deny access to wireless stations based on MAC addresses. Disable MAC address filtering to have the router not perform MAC filtering on the wireless stations.
Association	Define the filter action for the list of MAC addresses in the MAC address filter table. Select Deny to block access to the router, MAC addresses not listed will be allowed to access the router. Select Allow to permit access to the router, MAC addresses not listed will be denied access to the router.
#	This is the index number of the MAC address.
User Name	Enter a descriptive name for the MAC address.
MAC Address	Enter the MAC addresses (in XX:XX:XX:XX:XX:XX format) of the wireless stations that are allowed or denied access to the ZyWALL in these address fields.
Apply	Click Apply to save your changes back to the ZyWALL.
Reset	Click Reset to begin configuring this screen afresh.

6.13.1 EAP Authentication Overview

EAP (Extensible Authentication Protocol) is an authentication protocol that runs on top of the IEEE802.1x transport mechanism in order to support multiple types of user authentication. By using EAP to interact with an EAP-compatible RADIUS server, the access point helps a wireless station and a RADIUS server perform authentication.

The type of authentication you use depends on the RADIUS server or the AP.

Your ZyWALL supports EAP-MD5 (Message-Digest Algorithm 5) with the local user database.

The following figure shows an overview of authentication when you specify a RADIUS server on your access point.

Figure 41 EAP Authentication

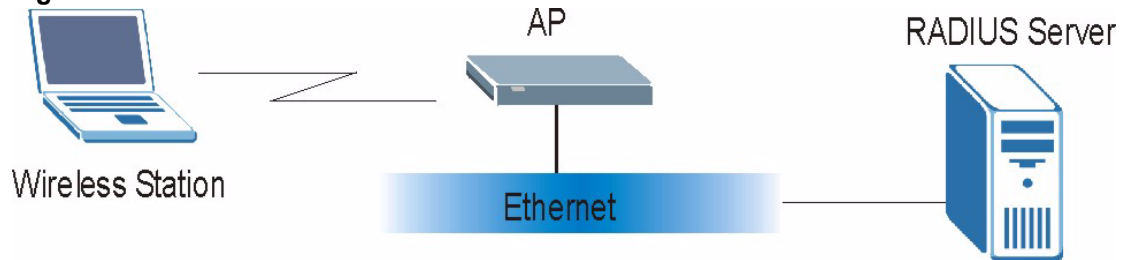

The details below provide a general description of how IEEE 802.1x EAP authentication works.

- The wireless station sends a start message to the ZyWALL.
- The ZyWALL sends a request identity message to the wireless station for identity information.
- The wireless station replies with identity information, including user name and password.
- The RADIUS server checks the user information against its user profile database and determines whether or not to authenticate the wireless station.

CHAPTER 7

WAN Screens

This chapter describes how to configure WAN settings.

7.1 WAN Overview

See [Chapter 3 on page 75](#) for more information on the fields in the WAN screens.

7.2 Multiple WAN

You can use a second connection for load sharing to increase overall network throughput or as a backup to enhance network reliability.

The ZyWALL has two WAN ports. You can connect one port to one ISP (or network) and connect the other to a second ISP (or network).

The ZyWALL can balance the load between the two WAN ports (see [Section 7.3 on page 132](#)).

You can use policy routing to specify the WAN port that specific services go through. An ISP may give traffic from certain (more expensive) connections priority over the traffic from other accounts. You could route delay intolerant traffic (like voice over IP calls) through this kind of connection. Other traffic could be routed through a cheaper broadband Internet connection that does not provide priority service. If one WAN port's connection goes down, the ZyWALL can automatically send its traffic through the other WAN port. See [Chapter 19 on page 319](#) for details.

The ZyWALL's NAT feature allows you to configure sets of rules for one WAN port and separate sets of rules for the other WAN port. Refer to [Chapter 17 on page 297](#) for details.

You can select through which WAN port you want to send out traffic from UPnP-enabled applications (see [Chapter 23 on page 377](#)).

The ZyWALL's DDNS lets you select which WAN interface you want to use for each individual domain name. The DDNS high availability feature lets you have the ZyWALL use the other WAN interface for a domain name if the configured WAN interface's connection goes down. See [Section 21.10.2 on page 350](#) for details.

When configuring a VPN rule, you have the option of selecting one of the ZyWALL's domain names in the **My Address** field.

7.3 Load Balancing Introduction

On the ZyWALL, load balancing is the process of dividing traffic loads between the two WAN interfaces (or ports). This allows you to improve quality of services and maximize bandwidth utilization.

See also policy routing to provide quality of service by dedicating a route for a specific traffic type and bandwidth management to specify a set amount of bandwidth for a specific traffic type on an interface.

7.4 Load Balancing Algorithms

The ZyWALL uses three load balancing methods (**Least Load First**, **Weighted Round Robin** and **Spillover**) to decide which WAN port the traffic for a session¹ (from the LAN) should use.

The following sections describe each load balancing method. The available bandwidth you configure on the ZyWALL refers to the actual bandwidth provided by the ISP and the measured bandwidth refers to as the bandwidth an interface is currently using.

7.4.1 Least Load First

The least load first algorithm uses the current (or recent) outbound and/or inbound bandwidth utilization of each WAN interface as the load balancing index(es) when making decisions about to which WAN interface a new LAN-originated session is to be distributed. The outbound bandwidth utilization is defined as the measured outbound throughput over the available outbound bandwidth and the inbound bandwidth utilization is defined as the measured inbound throughput over the available inbound bandwidth.

7.4.1.1 Example 1

The following figure depicts an example where both the WAN ports on the ZyWALL are connected to the Internet. The configured available outbound bandwidths for WAN 1 and WAN 2 are 512K and 256K respectively.

1. In the load balancing section, a session may refer to normal connection-oriented, UDP and SNMP2 traffic.

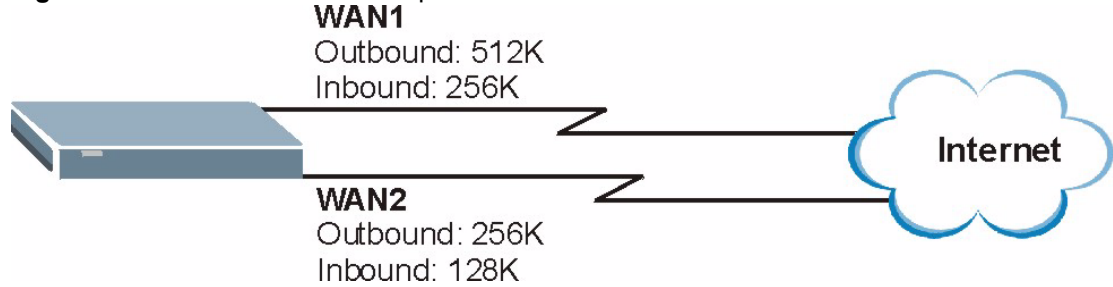
Figure 42 Least Load First Example

If the outbound bandwidth utilization is used as the load balancing index and the measured outbound throughput of WAN 1 is 412K and WAN 2 is 198K, the ZyWALL calculates the load balancing index as shown in the table below.

Since WAN 2 has a smaller load balancing index (meaning that it is less utilized than WAN 1), the ZyWALL will send the subsequent new session traffic through WAN 2.

Table 34 Least Load First: Example 1

INTERFACE	OUTBOUND		LOAD BALANCING INDEX (M/A)
	AVAILABLE (A)	MEASURED (M)	
WAN 1	512 K	412 K	0.8
WAN 2	256 K	198 K	0.77

7.4.1.2 Example 2

This example uses the same network scenario as in [Figure 42 on page 133](#), but uses both the outbound and inbound bandwidth utilization in calculating the load balancing index. If the measured inbound stream throughput for both WAN 1 and WAN 2 is 102K, the ZyWALL calculates the average load balancing indices as shown in the table below.

Since WAN 1 has a smaller load balancing index (meaning that it is less utilized than WAN 2), the ZyWALL will send the next new session traffic through WAN 1.

Table 35 Least Load First: Example 2

INTERFACE	OUTBOUND		INBOUND		AVERAGE LOAD BALANCING INDEX (OM / OA + IM / IA) / 2
	AVAILABLE (OA)	MEASURED (OM)	AVAILABLE (IA)	MEASURED (IM)	
WAN 1	512 K	412 K	256 K	102 K	(0.8 + 0.4) / 2 = 0.6
WAN 2	256 K	198 K	128 K	102 K	(0.77 + 0.8) / 2 = 0.79

7.4.2 Weighted Round Robin

Similar to the Round Robin (RR) algorithm, the Weighted Round Robin (WRR) algorithm sets the ZyWALL to send traffic through each WAN interface in turn. In addition, the WAN interfaces are assigned weights. An interface with a larger weight gets more of the traffic than an interface with a smaller weight.

This algorithm is best suited for situations when the bandwidths set for the two WAN interfaces are different.

For example, in the figure below, the configured available bandwidth of WAN1 is 1M and WAN2 is 512K. You can set the ZyWALL to distribute the network traffic between the two interfaces by setting the weight of WAN1 and WAN2 to 2 and 1 respectively. The ZyWALL assigns the traffic of two sessions to WAN1 for every session's traffic assigned to WAN2.

Figure 43 Weighted Round Robin Algorithm Example

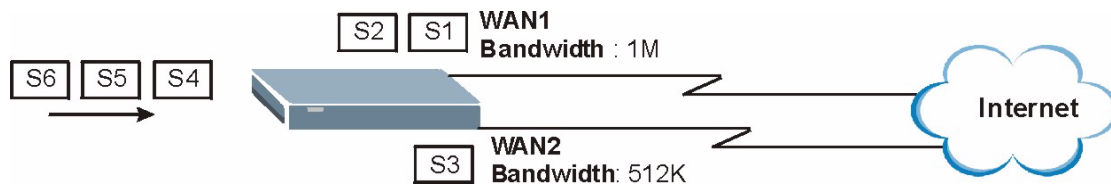

7.4.3 Spillover

With the spillover load balancing algorithm, the ZyWALL sends network traffic to the primary interface until the maximum allowable load is reached, then the ZyWALL sends the excess network traffic of new sessions to the secondary WAN interface. Configure the **Route Priority** metrics in the **WAN General** screen to determine the primary and secondary WANs.

In cases where the primary WAN interface uses an unlimited access Internet connection and the secondary WAN uses a per-use timed access plan, the ZyWALL will only use the secondary WAN interface when the traffic load reaches the upper threshold on the primary WAN interface. This allows you to fully utilize the bandwidth of the primary WAN interface while avoiding overloading it and reducing Internet connection fees at the same time.

In the following example figure, the upper threshold of the primary WAN interface is set to 800K. The ZyWALL sends network traffic of new sessions that exceeds this limit to the secondary WAN interface.

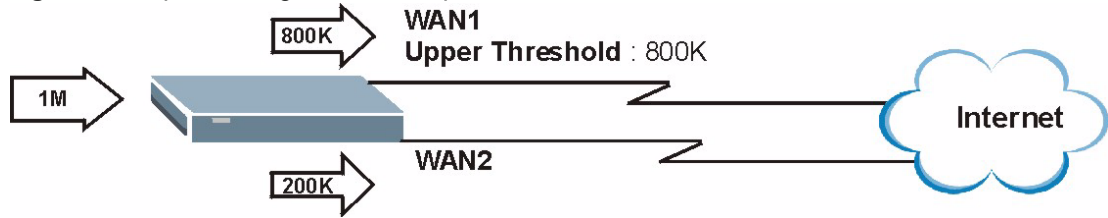
Figure 44 Spillover Algorithm Example

7.5 TCP/IP Priority (Metric)

The metric represents the "cost of transmission". A router determines the best route for transmission by choosing a path with the lowest "cost". RIP routing uses hop count as the measurement of cost, with a minimum of "1" for directly connected networks. The number must be between "1" and "15"; a number greater than "15" means the link is down. The smaller the number, the lower the "cost".

- 1 The metric sets the priority for the ZyWALL's routes to the Internet. Each route must have a unique metric.
- 2 The priorities of the WAN port routes must always be higher than the dial-backup and traffic redirect route priorities.

For example, let's say that you have the WAN operation mode set to active/passive and the WAN 1 route has a metric of "2", the WAN 2 route has a metric of "3", the traffic-redirect route has a metric of "14" and the dial-backup route has a metric of "15". In this case, the WAN 1 route acts as the primary default route. If the WAN 1 route fails to connect to the Internet, the ZyWALL tries the WAN 2 route next. If the WAN 2 route fails, the ZyWALL tries the traffic-redirect route. In the same manner, the ZyWALL uses the dial-backup route if the traffic-redirect route also fails.

The dial-backup or traffic redirect routes cannot take priority over the WAN 1 and WAN 2 routes.

7.6 Configuring General

Click **WAN** to open the **General** screen.

Figure 45 WAN General

WAN

General
WAN 1
WAN 2
Traffic Redirect
Dial Backup

Operation Mode

- Active/Passive (Fail Over) Mode
 - Fall Back to Primary WAN When Possible
- Active/Active Mode
 - Load Balancing Algorithm

Route Priority

WAN 1	Priority (metric)	<input type="text" value="1"/>	1(Highest) ~ 15(Lowest)
WAN 2	Priority (metric)	<input type="text" value="2"/>	1(Highest) ~ 15(Lowest)
Traffic Redirect	Priority (metric)	<input type="text" value="14"/>	1(Highest) ~ 15(Lowest)
Dial Backup	Priority (metric)	<input type="text" value="15"/>	1(Highest) ~ 15(Lowest)

Connectivity Check

Check Period 5 ~ 300 (Seconds)

Check Timeout 1 ~ 10 (Seconds)

Check Fail Tolerance 1 ~ 10 (Successive Checks)

- Check WAN 1 Connectivity
 - Ping Default Gateway
 - Ping this Address (Domain Name or IP Address)
- Check WAN 2 Connectivity
 - Ping Default Gateway
 - Ping this Address (Domain Name or IP Address)
- Check Traffic Redirection Connectivity
 - Ping Default Gateway
 - Ping this Address (Domain Name or IP Address)

Windows Networking (NetBIOS over TCP/IP)

- Allow between WAN and LAN (You also need to create a firewall rule!)
- Allow between WAN and DMZ
- Allow Trigger Dial

The following table describes the labels in this screen.

Table 36 WAN General

LABEL	DESCRIPTION
Active/Passive (Fail Over) Mode	Select the Active/Passive (fail over) operation mode to have the ZyWALL use the second highest priority WAN port as a back up. This means that the ZyWALL will normally use the highest priority (primary) WAN port (depending on the priorities you configure in the Route Priority fields). The ZyWALL will switch to the secondary (second highest priority) WAN port when the primary WAN port's connection fails.
Fall Back to Primary WAN When Possible	This field determines the action the ZyWALL takes after the primary WAN port fails and the ZyWALL starts using the secondary WAN port. Select this check box to have the ZyWALL change back to using the primary WAN port when the ZyWALL can connect through the primary WAN port again. Clear this check box to have the ZyWALL continue using the secondary WAN port, even after the ZyWALL can connect through the primary WAN port again. The ZyWALL continues to use the secondary WAN port until it's connection fails (at which time it will change back to using the primary WAN port if its connection is up).
Active/Active Mode	Select Active/Active Mode to have the ZyWALL use both of the WAN ports at the same time and allow you to enable load balancing.
Load Balancing Algorithm	Select Least Load First , Weighted Round Robin or Spillover to activate load balancing and set the related fields. Otherwise, select None . Refer to Section 7.7 on page 138 for load balancing configuration.
Route Priority	
WAN1 WAN2 Traffic Redirect Dial Backup	The default WAN connection is "1" as your broadband connection via the WAN port should always be your preferred method of accessing the WAN. The ZyWALL switches from WAN port 1 to WAN port 2 if WAN port 1's connection fails and then back to WAN port 1 when WAN port 1's connection comes back up. The default priority of the routes is WAN 1 , WAN 2 , Traffic Redirect and then Dial Backup : You have three choices for an auxiliary connection (WAN 2 , Traffic Redirect and Dial Backup) in the event that your regular WAN connection goes down. If Dial Backup is preferred to Traffic Redirect , then type "14" in the Dial Backup Priority (metric) field (and leave the Traffic Redirect Priority (metric) at the default of "15"). The Dial Backup field is available only when you enable the corresponding dial backup feature in the Dial Backup screen.
Connectivity Check	
Check Period	The ZyWALL tests a WAN connection by periodically sending a ping to either the default gateway or the address in the Ping this Address field. Type a number of seconds (5 to 300) to set the time interval between checks. Allow more time if your destination IP address handles lots of traffic.
Check Timeout	Type the number of seconds (1 to 10) for your ZyWALL to wait for a response to the ping before considering the check to have failed. This setting must be less than the Check Period . Use a higher value in this field if your network is busy or congested.
Check Fail Tolerance	Type how many WAN connection checks can fail (1-10) before the connection is considered "down" (not connected). The ZyWALL still checks a "down" connection to detect if it reconnects.

Table 36 WAN General (continued)

LABEL	DESCRIPTION
Check WAN1/2 Connectivity	<p>Select the check box to have the ZyWALL periodically test the respective WAN port's connection.</p> <p>Select Ping Default Gateway to have the ZyWALL ping the WAN port's default gateway IP address.</p> <p>Select Ping this Address and enter a domain name or IP address of a reliable nearby computer (for example, your ISP's DNS server address) to have the ZyWALL ping that address. For a domain name, use up to 63 alphanumeric characters (hyphens, periods and the underscore are also allowed) without spaces.</p>
Check Traffic Redirection Connectivity	<p>Select the check box to have the ZyWALL periodically test the traffic redirect connection.</p> <p>Select Ping Default Gateway to have the ZyWALL ping the backup gateway's IP address.</p> <p>Select Ping this Address and enter a domain name or IP address of a reliable nearby computer (for example, your ISP's DNS server address) to have the ZyWALL ping that address. For a domain name, use up to 63 alphanumeric characters (hyphens, periods and the underscore are also allowed) without spaces.</p>
Windows Networking (NetBIOS over TCP/IP):	<p>NetBIOS (Network Basic Input/Output System) are TCP or UDP packets that enable a computer to connect to and communicate with a LAN. For some dial-up services such as PPPoE or PPTP, NetBIOS packets cause unwanted calls.</p>
Allow between WAN and LAN	<p>Select this check box to forward NetBIOS packets from the LAN to the WAN and from the WAN to the LAN. If your firewall is enabled with the default policy set to block WAN to LAN traffic, you also need to enable the default WAN to LAN firewall rule that forwards NetBIOS traffic.</p> <p>Clear this check box to block all NetBIOS packets going from the LAN to the WAN and from the WAN to the LAN.</p>
Allow between WAN and DMZ	<p>Select this check box to forward NetBIOS packets from the WAN to the DMZ and from the DMZ to the WAN.</p> <p>Clear this check box to block all NetBIOS packets going from the WAN to the DMZ and from the DMZ to the WAN.</p>
Allow Trigger Dial	<p>Select this option to allow NetBIOS packets to initiate calls.</p>
Apply	<p>Click Apply to save your changes back to the ZyWALL.</p>
Reset	<p>Click Reset to begin configuring this screen afresh.</p>

7.7 Configuring Load Balancing

To configure load balancing on the ZyWALL, click **WAN** in the navigation panel. The **WAN General** screen displays by default. Select **Active/Active Mode** under **Operation Mode** to enable load balancing on the ZyWALL.

The **WAN General** screen varies depending on what you select in the **Load Balancing Algorithm** field.

7.7.1 Least Load First

To configure Least Load First, select **Least Load First** in the **Load Balancing Algorithm** field.

Figure 46 Load Balancing: Least Load First

The screenshot shows the WAN configuration interface with the following settings:

- Operation Mode:**
 - Active/Passive (Fail Over) Mode
 - Fall Back to Primary WAN When Possible
 - Active/Active Mode
- Load Balancing Algorithm:** Least Load First
- Time Frame:** 600 (10(Seconds) - 600(Seconds))
- Load Balancing Index(es):** Outbound Only

Interface	Available Inbound Bandwidth	Available Outbound Bandwidth
WAN 1	100 Kbps	100 Kbps
WAN 2	100 Kbps	100 Kbps

The following table describes the related fields in this screen.

Table 37 Load Balancing: Least Load First

LABEL	DESCRIPTION
Active/Active Mode	Select Active/Active Mode and set the related fields to enable load balancing on the ZyWALL.
Load Balancing Algorithm	Select a load balancing method to use from the drop-down list box.
Time Frame	You can set the ZyWALL to get the measured bandwidth using the average bandwidth in the specified time interval. Enter the time interval between 10 and 600 seconds.
Load Balancing Index(es)	Specify the direction of the traffic utilization you want the ZyWALL to use in calculating the load balancing index. Select Outbound Only , Inbound Only or Outbound + Inbound .
Interface	This field displays the name of the WAN interface (WAN1 and WAN2).
Available Inbound Bandwidth	This field is applicable when you select Outbound + Inbound or Inbound Only in the Load Balancing Index(es) field. Specify the inbound (or downstream) bandwidth (in kilo bites per second) for the interface.
Available Outbound Bandwidth	This field is applicable when you select Outbound + Inbound or Outbound Only in the Load Balancing Index(es) field. Specify the outbound (or upstream) bandwidth (in kilo bites per second) for the interface.

7.7.2 Weighted Round Robin

To load balance using the weighted round robin method, select **Weighted Round Robin** in the **Load Balancing Algorithm** field.

Figure 47 Load Balancing: Weighted Round Robin

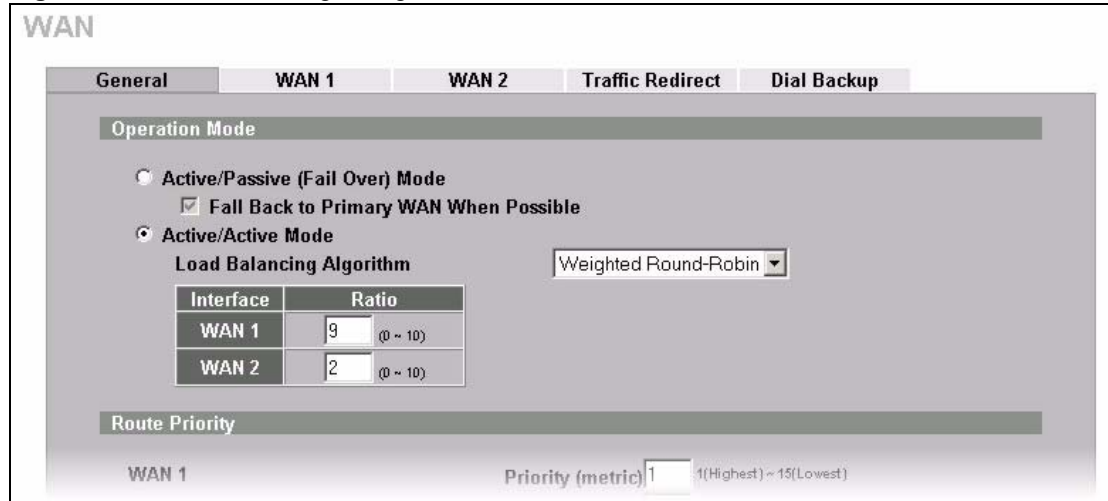

The following table describes the related fields in this screen.

Table 38 Load Balancing: Weighted Round Robin

LABEL	DESCRIPTION
Active/Active Mode	Select Active/Active Mode and set the related fields to enable load balancing on the ZyWALL.
Load Balancing Algorithm	Select a load balancing method to use from the drop-down list box.
Interface	This field displays the name of the WAN interface (WAN1 and WAN2).
Ratio	Specify the weighted ration for the interface. Enter 0 to set the ZyWALL not to send traffic load to the interface.

7.7.3 Spillover

To load balance using the spillover method, select **Spillover** in the **Load Balancing Algorithm** field.

Configure the **Route Priority** metrics in the **WAN General** screen to determine the primary and secondary WANs. By default, WAN1 is the primary WAN and WAN2 is the secondary WAN.

Figure 48 Load Balancing: Spillover

The screenshot shows the 'WAN' configuration page with the following settings:

- Operation Mode:**
 - Active/Passive (Fail Over) Mode
 - Fall Back to Primary WAN When Possible
 - Active/Active Mode
- Load Balancing Algorithm:** Spillover
- Time Frame:** 600 (10(Seconds) ~ 600(Seconds))
- Send traffic to secondary WAN when primary WAN bandwidth exceeds:** 1000 kbps

The following table describes the related fields in this screen.

Table 39 Load Balancing: Spillover

LABEL	DESCRIPTION
Active/Active Mode	Select Active/Active Mode and set the related fields to enable load balancing on the ZyWALL.
Load Balancing Algorithm	Select a load balancing method to use from the drop-down list box.
Time Frame	You can set the ZyWALL to get the measured bandwidth using the average bandwidth in the specified time interval. Enter the time interval between 10 and 600 seconds.
Send traffic to secondary WAN when primary WAN bandwidth exceeds	Specify the maximum allowable bandwidth on the primary WAN. Once this maximum bandwidth is reached, the ZyWALL sends the new session traffic that exceeds this limit to the secondary WAN. The ZyWALL continues to send traffic of existing session to the primary WAN.

7.7.3.1 WAN IP Address Assignment

Every computer on the Internet must have a unique IP address. If your networks are isolated from the Internet, for instance, only between your two branch offices, you can assign any IP addresses to the hosts without problems. However, the Internet Assigned Numbers Authority (IANA) has reserved the following three blocks of IP addresses specifically for private networks.

Table 40 Private IP Address Ranges

10.0.0.0	-	10.255.255.255
172.16.0.0	-	172.31.255.255
192.168.0.0	-	192.168.255.255

You can obtain your IP address from the IANA, from an ISP or have it assigned by a private network. If you belong to a small organization and your Internet access is through an ISP, the ISP can provide you with the Internet addresses for your local networks. On the other hand, if you are part of a much larger organization, you should consult your network administrator for the appropriate IP addresses.

Note: Regardless of your particular situation, do not create an arbitrary IP address; always follow the guidelines above. For more information on address assignment, please refer to RFC 1597, Address Allocation for Private Internets and RFC 1466, Guidelines for Management of IP Address Space.

7.7.3.2 DNS Server Address Assignment

Use DNS (Domain Name System) to map a domain name to its corresponding IP address and vice versa, for instance, the IP address of www.zyxel.com is 204.217.0.2. The DNS server is extremely important because without it, you must know the IP address of a computer before you can access it.

The ZyWALL can get the DNS server addresses in the following ways.

- 1 The ISP tells you the DNS server addresses, usually in the form of an information sheet, when you sign up. If your ISP gives you DNS server addresses, manually enter them in the DNS server fields.
- 2 If your ISP dynamically assigns the DNS server IP addresses (along with the ZyWALL's WAN IP address), set the DNS server fields to get the DNS server address from the ISP.
- 3 You can manually enter the IP addresses of other DNS servers. These servers can be public or private. A DNS server could even be behind a remote IPsec router (see [Section 21.5.1 on page 342](#)).

7.7.3.3 WAN MAC Address

Every Ethernet device has a unique MAC (Media Access Control) address. The MAC address is assigned at the factory and consists of six pairs of hexadecimal characters, for example, 00:A0:C5:00:00:02.

You can configure the WAN port's MAC address by either using the factory default or cloning the MAC address from a computer on your LAN. Once it is successfully configured, the address will be copied to the "rom" file (ZyNOS configuration file). It will not change unless you change the setting or upload a different "rom" file.

Table 41 Example of Network Properties for LAN Servers with Fixed IP Addresses

Choose an IP address	192.168.1.2-192.168.1.32; 192.168.1.65-192.168.1.254.
Subnet mask	255.255.255.0
Gateway (or default route)	192.168.1.1(ZyWALL LAN IP)

7.8 Configuring WAN Setup

To change your ZyWALL's WAN ISP, IP and MAC settings, click **WAN**, then the **WAN1** or **WAN2** tab. The screen differs by the encapsulation.

Note: The WAN1 and WAN2 IP addresses must be on different subnets.

The warning message "Warning! No NAT rule configured in system" appears in the status bar when NAT is set to use Full Feature address mapping rules, but there are no NAT address mapping rules configured.

7.8.1 Ethernet Encapsulation

The screen shown next is for **Ethernet** encapsulation.

Figure 49 WAN: Ethernet Encapsulation

The following table describes the labels in this screen.

Table 42 WAN: Ethernet Encapsulation

LABEL	DESCRIPTION
ISP Parameters for Internet Access	
Encapsulation	You must choose the Ethernet option when the WAN port is used as a regular Ethernet.
Service Type	Choose from Standard , Telstra (RoadRunner Telstra authentication method), RR-Manager (Roadrunner Manager authentication method), RR-Toshiba (Roadrunner Toshiba authentication method) or Telia Login . The following fields do not appear with the Standard service type.
User Name	Type the user name given to you by your ISP.
Password	Type the password associated with the user name above.

Table 42 WAN: Ethernet Encapsulation (continued)

LABEL	DESCRIPTION
Retype to Confirm	Type your password again to make sure that you have entered is correctly.
Login Server IP Address	Type the authentication server IP address here if your ISP gave you one. This field is not available for Telia Login.
Login Server (Telia Login only)	Type the domain name of the Telia login server, for example login1.telia.com.
Relogin Every(min) (Telia Login only)	The Telia server logs the ZyWALL out if the ZyWALL does not log in periodically. Type the number of minutes from 1 to 59 (30 default) for the ZyWALL to wait between logins.
WAN IP Address Assignment	
Get automatically from ISP	Select this option If your ISP did not assign you a fixed IP address. This is the default selection.
Use Fixed IP Address	Select this option If the ISP assigned a fixed IP address.
My WAN IP Address	Enter your WAN IP address in this field if you selected Use Fixed IP Address .
My WAN IP Subnet Mask	Enter the IP subnet mask (if your ISP gave you one) in this field if you selected Use Fixed IP Address .
Gateway IP Address	Enter the gateway IP address (if your ISP gave you one) in this field if you selected Use Fixed IP Address .
Advanced Setup	
Enable NAT (Network Address Translation)	<p>Network Address Translation (NAT) allows the translation of an Internet protocol address used within one network (for example a private IP address used in a local network) to a different IP address known within another network (for example a public IP address used on the Internet).</p> <p>Select this checkbox to enable NAT.</p> <p>See Chapter 17 on page 297 for more information about NAT.</p>
RIP Direction	<p>RIP (Routing Information Protocol) allows a router to exchange routing information with other routers. The RIP Direction field controls the sending and receiving of RIP packets.</p> <p>Choose Both, None, In Only or Out Only.</p> <p>When set to Both or Out Only, the ZyWALL will broadcast its routing table periodically.</p> <p>When set to Both or In Only, the ZyWALL will incorporate RIP information that it receives.</p> <p>When set to None, the ZyWALL will not send any RIP packets and will ignore any RIP packets received.</p> <p>By default, RIP Direction is set to Both.</p>

Table 42 WAN: Ethernet Encapsulation (continued)

LABEL	DESCRIPTION
RIP Version	<p>The RIP Version field controls the format and the broadcasting method of the RIP packets that the ZyWALL sends (it recognizes both formats when receiving).</p> <p>Choose RIP-1, RIP-2B or RIP-2M.</p> <p>RIP-1 is universally supported; but RIP-2 carries more information. RIP-1 is probably adequate for most networks, unless you have an unusual network topology. Both RIP-2B and RIP-2M sends the routing data in RIP-2 format; the difference being that RIP-2B uses subnet broadcasting while RIP-2M uses multicasting. Multicasting can reduce the load on non-router machines since they generally do not listen to the RIP multicast address and so will not receive the RIP packets. However, if one router uses multicasting, then all routers on your network must use multicasting, also. By default, the RIP Version field is set to RIP-1.</p>
Enable Multicast	<p>Select this check box to turn on IGMP (Internet Group Multicast Protocol). IGMP is a network-layer protocol used to establish membership in a Multicast group - it is not used to carry user data.</p>
Multicast Version	<p>Choose None (default), IGMP-V1 or IGMP-V2. IGMP (Internet Group Multicast Protocol) is a session-layer protocol used to establish membership in a Multicast group - it is not used to carry user data. IGMP version 2 (RFC 2236) is an improvement over version 1 (RFC 1112) but IGMP version 1 is still in wide use. If you would like to read more detailed information about interoperability between IGMP version 2 and version 1, please see sections 4 and 5 of RFC 2236.</p>
Spoof WAN MAC Address	<p>You can use the factory assigned default MAC Address or cloning the MAC address from a computer on your LAN.</p> <p>Otherwise, select the check box next to Spoof WAN MAC Address and enter the IP address of the computer on the LAN whose MAC you are cloning. Once it is successfully configured, the address will be copied to the rom file (ZyNOS configuration file). It will not change unless you change the setting or upload a different ROM file.</p>
Clone the computer's MAC address - IP Address	<p>Enter the IP address of the computer on the LAN whose MAC you are cloning. It is recommended that you clone the MAC address prior to hooking up the WAN port.</p>
Apply	<p>Click Apply to save your changes back to the ZyWALL.</p>
Reset	<p>Click Reset to begin configuring this screen afresh.</p>

7.8.2 PPPoE Encapsulation

The ZyWALL supports PPPoE (Point-to-Point Protocol over Ethernet). PPPoE is an IETF Draft standard (RFC 2516) specifying how a personal computer (PC) interacts with a broadband modem (DSL, cable, wireless, etc.) connection. The **PPPoE** option is for a dial-up connection using PPPoE.

For the service provider, PPPoE offers an access and authentication method that works with existing access control systems (for example Radius). PPPoE provides a login and authentication method that the existing Microsoft Dial-Up Networking software can activate, and therefore requires no new learning or procedures for Windows users.

One of the benefits of PPPoE is the ability to let you access one of multiple network services, a function known as dynamic service selection. This enables the service provider to easily

create and offer new IP services for individuals.

Operationally, PPPoE saves significant effort for both you and the ISP or carrier, as it requires no specific configuration of the broadband modem at the customer site.

By implementing PPPoE directly on the ZyWALL (rather than individual computers), the computers on the LAN do not need PPPoE software installed, since the ZyWALL does that part of the task. Furthermore, with NAT, all of the LANs' computers will have access.

Refer to [Appendix E on page 603](#) for more information on PPPoE.

The screen shown next is for **PPPoE** encapsulation.

Figure 50 WAN: PPPoE Encapsulation

WAN

General **WAN 1** WAN 2 Traffic Redirect Dial Backup

ISP Parameters for Internet Access

Encapsulation (Optional)

Service Name

User Name

Password

Retype to Confirm

Authentication Type

Nailed-Up

Idle Timeout (Seconds)

WAN IP Address Assignment

Get Automatically from ISP

Use Fixed IP Address

My WAN IP Address

Advanced Setup

Enable NAT (Network Address Translation)

RIP Direction

RIP Version

Enable Multicast

Multicast Version

Snoop WAN MAC Address

Clone the computer's MAC address - IP Address

The following table describes the labels in this screen.

Table 43 WAN: PPPoE Encapsulation

LABEL	DESCRIPTION
ISP Parameters for Internet Access	
Encapsulation	The PPPoE choice is for a dial-up connection using PPPoE. The router supports PPPoE (Point-to-Point Protocol over Ethernet). PPPoE is an IETF Draft standard (RFC 2516) specifying how a personal computer (PC) interacts with a broadband modem (i.e. DSL, cable, wireless, etc.) connection. Operationally, PPPoE saves significant effort for both the end user and ISP/carrier, as it requires no specific configuration of the broadband modem at the customer site. By implementing PPPoE directly on the router rather than individual computers, the computers on the LAN do not need PPPoE software installed, since the router does that part of the task. Further, with NAT, all of the LAN's computers will have access.
Service Name	Type the PPPoE service name provided to you. PPPoE uses a service name to identify and reach the PPPoE server.
User Name	Type the user name given to you by your ISP.
Password	Type the password associated with the user name above.
Retype to Confirm	Type your password again to make sure that you have entered is correctly.
Authentication Type	Use the drop-down list box to select an authentication protocol for outgoing calls. Options are: CHAP/PAP - Your ZyWALL accepts either CHAP or PAP when requested by this remote node. CHAP - Your ZyWALL accepts CHAP only. PAP - Your ZyWALL accepts PAP only.
Nailed-Up	Select Nailed-Up if you do not want the connection to time out.
Idle Timeout	This value specifies the time in seconds that elapses before the ZyWALL automatically disconnects from the PPPoE server.
WAN IP Address Assignment	
Get automatically from ISP	Select this option if your ISP did not assign you a fixed IP address. This is the default selection.
Use Fixed IP Address	Select this option if the ISP assigned a fixed IP address.
My WAN IP Address	Enter your WAN IP address in this field if you selected Use Fixed IP Address .
Advanced Setup	
Enable NAT (Network Address Translation)	Network Address Translation (NAT) allows the translation of an Internet protocol address used within one network (for example a private IP address used in a local network) to a different IP address known within another network (for example a public IP address used on the Internet). Select this checkbox to enable NAT. For more information about NAT see Chapter 17 on page 297 .

Table 43 WAN: PPPoE Encapsulation

LABEL	DESCRIPTION
RIP Direction	<p>RIP (Routing Information Protocol) allows a router to exchange routing information with other routers. The RIP Direction field controls the sending and receiving of RIP packets.</p> <p>Choose Both, None, In Only or Out Only.</p> <p>When set to Both or Out Only, the ZyWALL will broadcast its routing table periodically.</p> <p>When set to Both or In Only, the ZyWALL will incorporate RIP information that it receives.</p> <p>When set to None, the ZyWALL will not send any RIP packets and will ignore any RIP packets received.</p> <p>By default, RIP Direction is set to Both.</p>
RIP Version	<p>The RIP Version field controls the format and the broadcasting method of the RIP packets that the ZyWALL sends (it recognizes both formats when receiving).</p> <p>Choose RIP-1, RIP-2B or RIP-2M.</p> <p>RIP-1 is universally supported; but RIP-2 carries more information. RIP-1 is probably adequate for most networks, unless you have an unusual network topology. Both RIP-2B and RIP-2M sends the routing data in RIP-2 format; the difference being that RIP-2B uses subnet broadcasting while RIP-2M uses multicasting. Multicasting can reduce the load on non-router machines since they generally do not listen to the RIP multicast address and so will not receive the RIP packets. However, if one router uses multicasting, then all routers on your network must use multicasting, also. By default, the RIP Version field is set to RIP-1.</p>
Enable Multicast	<p>Select this check box to turn on IGMP (Internet Group Multicast Protocol). IGMP is a network-layer protocol used to establish membership in a Multicast group - it is not used to carry user data.</p>
Multicast Version	<p>Choose None (default), IGMP-V1 or IGMP-V2. IGMP (Internet Group Multicast Protocol) is a session-layer protocol used to establish membership in a Multicast group – it is not used to carry user data. IGMP version 2 (RFC 2236) is an improvement over version 1 (RFC 1112) but IGMP version 1 is still in wide use. If you would like to read more detailed information about interoperability between IGMP version 2 and version 1, please see sections 4 and 5 of RFC 2236.</p>
Spoof WAN MAC Address	<p>You can use the factory assigned default MAC Address or cloning the MAC address from a computer on your LAN.</p> <p>Otherwise, select the check box next to Spoof WAN MAC Address and enter the IP address of the computer on the LAN whose MAC you are cloning. Once it is successfully configured, the address will be copied to the rom file (ZyNOS configuration file). It will not change unless you change the setting or upload a different ROM file.</p>
Clone the computer's MAC address – IP Address	<p>Enter the IP address of the computer on the LAN whose MAC you are cloning. It is recommended that you clone the MAC address prior to hooking up the WAN port.</p>
Apply	<p>Click Apply to save your changes back to the ZyWALL.</p>
Reset	<p>Click Reset to begin configuring this screen afresh.</p>

7.8.3 PPTP Encapsulation

Point-to-Point Tunneling Protocol (PPTP) is a network protocol that enables secure transfer of data from a remote client to a private server, creating a Virtual Private Network (VPN) using TCP/IP-based networks.

PPTP supports on-demand, multi-protocol and virtual private networking over public networks, such as the Internet. The screen shown next is for **PPTP** encapsulation.

Refer to [Appendix F on page 605](#) for more information on PPTP.

Figure 51 WAN: PPTP Encapsulation

The screenshot shows the WAN configuration interface for PPTP Encapsulation. The page is titled "WAN" and has tabs for "General", "WAN 1", "WAN 2", "Traffic Redirect", and "Dial Backup". The "WAN 1" tab is selected. The configuration is divided into three sections: "ISP Parameters for Internet Access", "WAN IP Address Assignment", and "Advanced Setup".

ISP Parameters for Internet Access

- Encapsulation: PPP over Ethernet (dropdown)
- Service Name: (Optional) (text input)
- User Name: (text input)
- Password: (password input)
- Retype to Confirm: (password input)
- Authentication Type: CHAP/PAP (dropdown)
- Nailed-Up
- Idle Timeout: 0 (Seconds) (text input)

WAN IP Address Assignment

- Get Automatically from ISP
- Use Fixed IP Address
- My WAN IP Address: 0 . 0 . 0 . 0 (text input)

Advanced Setup

- Enable NAT (Network Address Translation)
- RIP Direction: None (dropdown)
- RIP Version: RIP-1 (dropdown)
- Enable Multicast
- Multicast Version: IGMP-v1 (dropdown)
- Spoof WAN MAC Address
- Clone the computer's MAC address - IP Address: 192 . 168 . 1 . 33 (text input)

Buttons: Apply, Reset

The following table describes the labels in this screen.

Table 44 WAN: PPTP Encapsulation

LABEL	DESCRIPTION
ISP Parameters for Internet Access	
Encapsulation	Point-to-Point Tunneling Protocol (PPTP) is a network protocol that enables secure transfer of data from a remote client to a private server, creating a Virtual Private Network (VPN) using TCP/IP-based networks. PPTP supports on-demand, multi-protocol, and virtual private networking over public networks, such as the Internet. The ZyWALL supports only one PPTP server connection at any given time. To configure a PPTP client, you must configure the User Name and Password fields for a PPP connection and the PPTP parameters for a PPTP connection.
User Name	Type the user name given to you by your ISP.
Password	Type the password associated with the user name above.
Retype to Confirm	Type your password again to make sure that you have entered is correctly.
Authentication Type	Use the drop-down list box to select an authentication protocol for outgoing calls. Options are: CHAP/PAP - Your ZyWALL accepts either CHAP or PAP when requested by this remote node. CHAP - Your ZyWALL accepts CHAP only. PAP - Your ZyWALL accepts PAP only.
Nailed-up	Select Nailed-Up if you do not want the connection to time out.
Idle Timeout	This value specifies the time in seconds that elapses before the ZyWALL automatically disconnects from the PPTP server.
PPTP Configuration	
My IP Address	Type the (static) IP address assigned to you by your ISP.
My IP Subnet Mask	Your ZyWALL will automatically calculate the subnet mask based on the IP address that you assign. Unless you are implementing subnetting, use the subnet mask computed by the ZyWALL.
Server IP Address	Type the IP address of the PPTP server.
Connection ID/ Name	Type your identification name for the PPTP server.
WAN IP Address Assignment	
Get automatically from ISP	Select this option If your ISP did not assign you a fixed IP address. This is the default selection.
Use Fixed IP Address	Select this option If the ISP assigned a fixed IP address.
My WAN IP Address	Enter your WAN IP address in this field if you selected Use Fixed IP Address .
Advanced Setup	

Table 44 WAN: PPTP Encapsulation

LABEL	DESCRIPTION
Enable NAT (Network Address Translation)	<p>Network Address Translation (NAT) allows the translation of an Internet protocol address used within one network (for example a private IP address used in a local network) to a different IP address known within another network (for example a public IP address used on the Internet).</p> <p>Select this checkbox to enable NAT.</p> <p>For more information about NAT see Chapter 17 on page 297.</p>
RIP Direction	<p>RIP (Routing Information Protocol) allows a router to exchange routing information with other routers. The RIP Direction field controls the sending and receiving of RIP packets.</p> <p>Choose Both, None, In Only or Out Only.</p> <p>When set to Both or Out Only, the ZyWALL will broadcast its routing table periodically.</p> <p>When set to Both or In Only, the ZyWALL will incorporate RIP information that it receives.</p> <p>When set to None, the ZyWALL will not send any RIP packets and will ignore any RIP packets received.</p> <p>By default, RIP Direction is set to Both.</p>
RIP Version	<p>The RIP Version field controls the format and the broadcasting method of the RIP packets that the ZyWALL sends (it recognizes both formats when receiving).</p> <p>Choose RIP-1, RIP-2B or RIP-2M.</p> <p>RIP-1 is universally supported; but RIP-2 carries more information. RIP-1 is probably adequate for most networks, unless you have an unusual network topology. Both RIP-2B and RIP-2M sends the routing data in RIP-2 format; the difference being that RIP-2B uses subnet broadcasting while RIP-2M uses multicasting. Multicasting can reduce the load on non-router machines since they generally do not listen to the RIP multicast address and so will not receive the RIP packets. However, if one router uses multicasting, then all routers on your network must use multicasting, also. By default, the RIP Version field is set to RIP-1.</p>
Enable Multicast	<p>Select this check box to turn on IGMP (Internet Group Multicast Protocol). IGMP is a network-layer protocol used to establish membership in a Multicast group - it is not used to carry user data.</p>
Multicast Version	<p>Choose None (default), IGMP-V1 or IGMP-V2. IGMP (Internet Group Multicast Protocol) is a session-layer protocol used to establish membership in a Multicast group – it is not used to carry user data. IGMP version 2 (RFC 2236) is an improvement over version 1 (RFC 1112) but IGMP version 1 is still in wide use. If you would like to read more detailed information about interoperability between IGMP version 2 and version 1, please see sections 4 and 5 of RFC 2236.</p>
Spoof WAN MAC Address	<p>You can use the factory assigned default MAC Address or cloning the MAC address from a computer on your LAN.</p> <p>Otherwise, select the check box next to Spoof WAN MAC Address and enter the IP address of the computer on the LAN whose MAC you are cloning. Once it is successfully configured, the address will be copied to the rom file (ZyNOS configuration file). It will not change unless you change the setting or upload a different ROM file.</p>
Clone the computer's MAC address – IP Address	<p>Enter the IP address of the computer on the LAN whose MAC you are cloning. It is recommended that you clone the MAC address prior to hooking up the WAN port.</p>
Apply	<p>Click Apply to save your changes back to the ZyWALL.</p>
Reset	<p>Click Reset to begin configuring this screen afresh.</p>

7.9 Traffic Redirect

Traffic redirect forwards WAN traffic to a backup gateway when the ZyWALL cannot connect to the Internet through its normal gateway. Connect the backup gateway on the WAN so that the ZyWALL still provides firewall protection.

Figure 52 Traffic Redirect WAN Setup

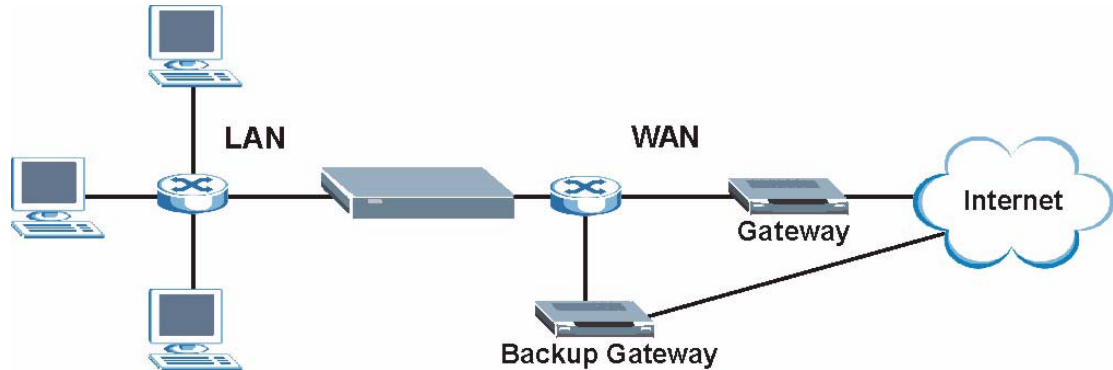

The following network topology allows you to avoid triangle route security issues (see [Appendix H on page 623](#)) when the backup gateway is connected to the LAN or DMZ. Use IP alias to configure the LAN into two or three logical networks with the ZyWALL itself as the gateway for each LAN network. Put the protected LAN in one subnet (Subnet 1 in the following figure) and the backup gateway in another subnet (Subnet 2). Configure a LAN to LAN/ZyWALL firewall rule that forwards packets from the protected LAN (Subnet 1) to the backup gateway (Subnet 2).

Figure 53 Traffic Redirect LAN Setup

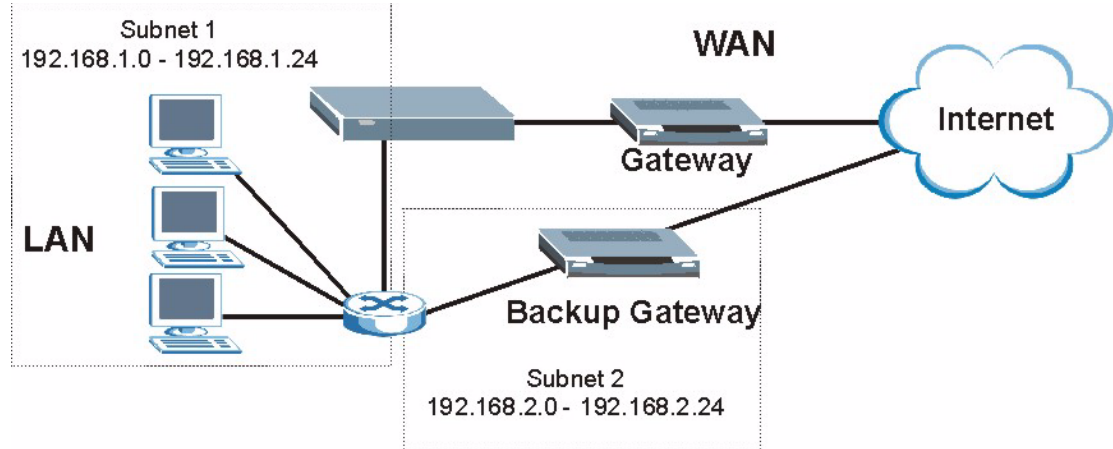

7.10 Configuring Traffic Redirect

To change your ZyWALL's Traffic Redirect settings, click **WAN**, then the **Traffic Redirect** tab. The screen appears as shown.

Figure 54 Traffic Redirect

The following table describes the labels in this screen.

Table 45 Traffic Redirect

LABEL	DESCRIPTION
Active	Select this check box to have the ZyWALL use traffic redirect if the normal WAN connection goes down.
Backup Gateway IP Address	Type the IP address of your backup gateway in dotted decimal notation. The ZyWALL automatically forwards traffic to this IP address if the ZyWALL's Internet connection terminates.
Apply	Click Apply to save your changes back to the ZyWALL.
Reset	Click Reset to begin configuring this screen afresh.

7.11 Configuring Dial Backup

To change your ZyWALL's Dial Backup settings, click **WAN**, then the **Dial Backup** tab. The screen appears as shown.

Figure 55 Dial Backup Setup

WAN

General WAN 1 WAN 2 Traffic Redirect **Dial Backup**

Dial Backup Setup

Enable Dial Backup

Basic Settings

Login Name:

Password:

Retype to Confirm:

Authentication Type:

Primary Phone Number:

Secondary Phone Number: (Optional)

Dial Backup Port Speed:

AT Command Initial String:

Advanced Modem Setup:

TCP/IP Options

Get IP Address Automatically from Remote Server

Use Fixed IP Address

My WAN IP Address:

Remote IP Subnet Mask:

Remote Node IP Address:

Enable NAT (Network Address Translation)

Enable RIP

RIP Version:

RIP Direction:

Broadcast Dial Backup Route

Enable Multicast

Multicast Version:

PPP Options

PPP Encapsulation:

Enable Compression

Budget

Always On

Configure Budget

Allocated Budget: (Minutes)

Period: (Hours)

Idle Timeout: (Seconds)

The following table describes the labels in this screen.

Table 46 Dial Backup Setup

LABEL	DESCRIPTION
Dial Backup Setup	
Enable Dial Backup	Select this check box to turn on dial backup.
Basic Settings	
Login Name	Type the login name assigned by your ISP.
Password	Type the password assigned by your ISP.
Retype to Confirm	Type your password again to make sure that you have entered is correctly.
Authentication Type	Use the drop-down list box to select an authentication protocol for outgoing calls. Options are: CHAP/PAP - Your ZyWALL accepts either CHAP or PAP when requested by this remote node. CHAP - Your ZyWALL accepts CHAP only. PAP - Your ZyWALL accepts PAP only.
Primary/ Secondary Phone Number	Type the first (primary) phone number from the ISP for this remote node. If the Primary Phone number is busy or does not answer, your ZyWALL dials the Secondary Phone number if available. Some areas require dialing the pound sign # before the phone number for local calls. Include a # symbol at the beginning of the phone numbers as required.
Dial Backup Port Speed	Use the drop-down list box to select the speed of the connection between the Dial Backup port and the external device. Available speeds are: 9600, 19200, 38400, 57600, 115200 or 230400 bps.
AT Command Initial String	Type the AT command string to initialize the WAN device. Consult the manual of your WAN device connected to your Dial Backup port for specific AT commands.
Advanced Modem Setup	Click Edit to display the Advanced Setup screen and edit the details of your dial backup setup.
TCP/IP Options	
Get IP Address Automatically from Remote Server	Type the login name assigned by your ISP for this remote node.
Used Fixed IP Address	Select this check box if your ISP assigned you a fixed IP address, then enter the IP address in the following field.
My WAN IP Address	Leave the field set to 0.0.0.0 (default) to have the ISP or other remote router dynamically (automatically) assign your WAN IP address if you do not know it. Type your WAN IP address here if you know it (static). This is the address assigned to your local ZyWALL, not the remote router.
Remote IP Subnet Mask	Leave this field set to 0.0.0.0 (default) to have the ISP or other remote router dynamically send its subnet mask if you do not know it. Type the remote gateway's subnet mask here if you know it (static).
Remote Node IP Address	Leave this field set to 0.0.0.0 (default) to have the ISP or other remote router dynamically (automatically) send its IP address if you do not know it. Type the remote gateway's IP address here if you know it (static).
Enable NAT (Network Address Translation)	Network Address Translation (NAT) allows the translation of an Internet protocol address used within one network to a different IP address known within another network. Select the check box to enable NAT. Clear the check box to disable NAT so the ZyWALL does not perform any NAT mapping for the dial backup connection.

Table 46 Dial Backup Setup (continued)

LABEL	DESCRIPTION
Enable RIP	Select this check box to turn on RIP (Routing Information Protocol), which allows a router to exchange routing information with other routers.
RIP Version	<p>The RIP Version field controls the format and the broadcasting method of the RIP packets that the ZyWALL sends (it recognizes both formats when receiving). Choose RIP-1, RIP-2B or RIP-2M.</p> <p>RIP-1 is universally supported; but RIP-2 carries more information. RIP-1 is probably adequate for most networks, unless you have an unusual network topology. Both RIP-2B and RIP-2M sends the routing data in RIP-2 format; the difference being that RIP-2B uses subnet broadcasting while RIP-2M uses multicasting. Multicasting can reduce the load on non-router machines since they generally do not listen to the RIP multicast address and so will not receive the RIP packets. However, if one router uses multicasting, then all routers on your network must use multicasting, also.</p>
RIP Direction	<p>RIP (Routing Information Protocol) allows a router to exchange routing information with other routers. The RIP Direction field controls the sending and receiving of RIP packets.</p> <p>Choose Both, In Only or Out Only.</p> <p>When set to Both or Out Only, the ZyWALL will broadcast its routing table periodically.</p> <p>When set to Both or In Only, the ZyWALL will incorporate RIP information that it receives.</p>
Broadcast Dial Backup Route	Select this check box to forward the backup route broadcasts to the WAN.
Enable Multicast	Select this check box to turn on IGMP (Internet Group Multicast Protocol). IGMP is a network-layer protocol used to establish membership in a Multicast group - it is not used to carry user data.
Multicast Version	Select IGMP-v1 or IGMP-v2 . IGMP version 2 (RFC 2236) is an improvement over version 1 (RFC 1112) but IGMP version 1 is still in wide use. If you would like to read more detailed information about interoperability between IGMP version 2 and version 1, please see <i>sections 4 and 5 of RFC 2236</i> .
PPP Options	
PPP Encapsulation	Select CISCO PPP from the drop-down list box if your dial backup WAN device uses Cisco PPP encapsulation, otherwise select Standard PPP .
Enable Compression	Select this check box to turn on stac compression.
Budget	
Always On	Select this check box to have the dial backup connection on all of the time.
Configure Budget	Select this check box to have the dial backup connection on during the time that you select.
Allocated Budget	Type the amount of time (in minutes) that the dial backup connection can be used during the time configured in the Period field. Set an amount that is less than the time period configured in the Period field.
Period	Type the time period (in hours) for how often the budget should be reset. For example, to allow calls to this remote node for a maximum of 10 minutes every hour, set the Allocated Budget to 10 (minutes) and the Period to 1 (hour).
Idle Timeout	Type the number of seconds of idle time (when there is no traffic from the ZyWALL to the remote node) for the ZyWALL to wait before it automatically disconnects the dial backup connection. This option applies only when the ZyWALL initiates the call. The dial backup connection never times out if you set this field to "0" (it is the same as selecting Always On).

Table 46 Dial Backup Setup (continued)

LABEL	DESCRIPTION
Apply	Click Apply to save your changes back to the ZyWALL.
Reset	Click Reset to begin configuring this screen afresh.

7.12 Advanced Modem Setup

7.12.1 AT Command Strings

For regular telephone lines, the default Dial string tells the modem that the line uses tone dialing. `ATDT` is the command for a switch that requires tone dialing. If your switch requires pulse dialing, change the string to `ATDP`.

For ISDN lines, there are many more protocols and operational modes. Please consult the documentation of your TA. You may need additional commands in both Dial and Init strings.

7.12.2 DTR Signal

The majority of WAN devices default to hanging up the current call when the DTR (Data Terminal Ready) signal is dropped by the DTE. When the Drop DTR When Hang Up check box is selected, the ZyWALL uses this hardware signal to force the WAN device to hang up, in addition to issuing the drop command `ATH`.

7.12.3 Response Strings

The response strings tell the ZyWALL the tags, or labels, immediately preceding the various call parameters sent from the WAN device. The response strings have not been standardized; please consult the documentation of your WAN device to find the correct tags.

7.13 Configuring Advanced Modem Setup

Click the **Edit** button in the **Dial Backup** screen to display the **Advanced Setup** screen shown next.

Note: Consult the manual of your WAN device connected to your dial backup port for specific AT commands.

Figure 56 Advanced Setup

WAN - ADVANCED MODEM SETUP

AT Command Strings

Dial

Drop

Answer

Drop DTR When Hang Up

AT Response Strings

CLID

Called ID

Speed

Call Control

Dial Timeout (sec)

Retry Count

Retry Interval (sec)

Drop Timeout (sec)

Call Back Delay (sec)

The following table describes the labels in this screen.

Table 47 Advanced Setup

LABEL	DESCRIPTION
AT Command Strings	
Dial	Type the AT Command string to make a call.
Drop	Type the AT Command string to drop a call. "~" represents a one second wait, for example, "~~~+++~~ath" can be used if your modem has a slow response time.
Answer	Type the AT Command string to answer a call.
Drop DTR When Hang Up	Select this check box to have the ZyWALL drop the DTR (Data Terminal Ready) signal after the "AT Command String: Drop" is sent out.
AT Response Strings	
CLID	Type the keyword that precedes the CLID (Calling Line Identification) in the AT response string. This lets the ZyWALL capture the CLID in the AT response string that comes from the WAN device. CLID is required for CLID authentication.
Called ID	Type the keyword preceding the dialed number.
Speed	Type the keyword preceding the connection speed.
Call Control	

Table 47 Advanced Setup (continued)

LABEL	DESCRIPTION
Dial Timeout (sec)	Type a number of seconds for the ZyWALL to try to set up an outgoing call before timing out (stopping).
Retry Count	Type a number of times for the ZyWALL to retry a busy or no-answer phone number before blacklisting the number.
Retry Interval (sec)	Type a number of seconds for the ZyWALL to wait before trying another call after a call has failed. This applies before a phone number is blacklisted.
Drop Timeout (sec)	Type the number of seconds for the ZyWALL to wait before dropping the DTR signal if it does not receive a positive disconnect confirmation.
Call Back Delay (sec)	Type a number of seconds for the ZyWALL to wait between dropping a callback request call and dialing the corresponding callback call.
Apply	Click Apply to save your changes back to the ZyWALL.
Cancel	Click Cancel to exit this screen without saving.

CHAPTER 8

DMZ Screens

This chapter describes how to configure the ZyWALL's DMZ.

8.1 DMZ Overview

The DeMilitarized Zone (DMZ) provides a way for public servers (Web, e-mail, FTP, etc.) to be visible to the outside world (while still being protected from DoS (Denial of Service) attacks such as SYN flooding and Ping of Death). These public servers can also still be accessed from the secure LAN.

By default the firewall allows traffic between the WAN and the DMZ, traffic from the DMZ to the LAN is denied, and traffic from the LAN to the DMZ is allowed. Internet users can have access to host servers on the DMZ but no access to the LAN, unless special filter rules allowing access were configured by the administrator or the user is an authorized remote user.

It is highly recommended that you connect all of your public servers to the DMZ port(s).

It is also highly recommended that you keep all sensitive information off of the public servers connected to the DMZ port. Store sensitive information on LAN computers.

8.2 Configuring DMZ

The DMZ and the connected computers can have private or public IP addresses.

When the DMZ uses public IP addresses, the WAN and DMZ ports must use public IP addresses that are on separate subnets. See [Appendix D on page 595](#) for information on IP subnetting. If you do not configure SUA NAT or any full feature NAT mapping rules for the public IP addresses on the DMZ, the ZyWALL will route traffic to the public IP addresses on the DMZ without performing NAT. This may be useful for hosting servers for NAT unfriendly applications (see [Chapter 17 on page 297](#) for more information).

If the DMZ computers use private IP addresses, use NAT if you want to make them publicly accessible.

Unlike the LAN, the ZyWALL does not assign TCP/IP configuration via DHCP to computers connected to the DMZ ports. Manually assign the computers static IP addresses (in the same subnet as the DMZ port's IP address), DNS server addresses and the ZyWALL's DMZ IP address as the default gateway.

From the main menu, click **DMZ**. The screen appears as shown next.

Figure 57 DMZ

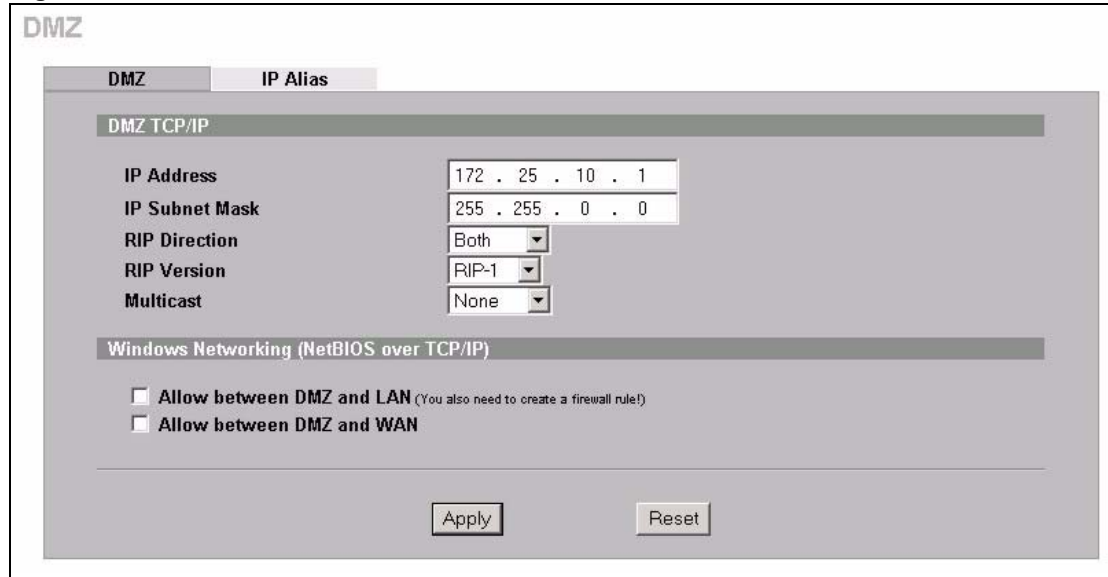

The following table describes the labels in this screen.

Table 48 DMZ

LABEL	DESCRIPTION
DMZ TCP/IP	
IP Address	Type the IP address of your ZyWALL's DMZ port in dotted decimal notation. Note: Make sure the IP addresses of the LAN, WAN and DMZ are on separate subnets.
IP Subnet Mask	The subnet mask specifies the network number portion of an IP address. Your ZyWALL will automatically calculate the subnet mask based on the IP address that you assign. Unless you are implementing subnetting, use the subnet mask computed by the ZyWALL 255.255.255.0.
RIP Direction	RIP (Routing Information Protocol, RFC1058 and RFC 1389) allows a router to exchange routing information with other routers. The RIP Direction field controls the sending and receiving of RIP packets. Select the RIP direction from Both/In Only/Out Only/None . When set to Both or Out Only , the ZyWALL will broadcast its routing table periodically. When set to Both or In Only , it will incorporate the RIP information that it receives; when set to None , it will not send any RIP packets and will ignore any RIP packets received. Both is the default.
RIP Version	The RIP Version field controls the format and the broadcasting method of the RIP packets that the ZyWALL sends (it recognizes both formats when receiving). RIP-1 is universally supported but RIP-2 carries more information. RIP-1 is probably adequate for most networks, unless you have an unusual network topology. Both RIP-2B and RIP-2M sends the routing data in RIP-2 format; the difference being that RIP-2B uses subnet broadcasting while RIP-2M uses multicasting. Multicasting can reduce the load on non-router machines since they generally do not listen to the RIP multicast address and so will not receive the RIP packets. However, if one router uses multicasting, then all routers on your network must use multicasting, also. By default, RIP direction is set to Both and the Version set to RIP-1 .

Table 48 DMZ (continued)

LABEL	DESCRIPTION
Multicast	Select IGMP V-1 or IGMP V-2 or None . IGMP (Internet Group Multicast Protocol) is a network-layer protocol used to establish membership in a Multicast group - it is not used to carry user data. IGMP version 2 (RFC 2236) is an improvement over version 1 (RFC 1112) but IGMP version 1 is still in wide use. If you would like to read more detailed information about interoperability between IGMP version 2 and version 1, please see <i>sections 4 and 5 of RFC 2236</i> .
Windows Networking (NetBIOS over TCP/IP)	
Allow between DMZ and LAN	Select this check box to forward NetBIOS packets from the LAN to the DMZ and from the DMZ to the LAN. If your firewall is enabled with the default policy set to block DMZ to LAN traffic, you also need to enable the default DMZ to LAN firewall rule that forwards NetBIOS traffic. Clear this check box to block all NetBIOS packets going from the LAN to the DMZ and from the DMZ to the LAN.
Allow between DMZ and WAN	Select this check box to forward NetBIOS packets from the WAN to the DMZ and from the DMZ to the WAN. Clear this check box to block all NetBIOS packets going from the WAN to the DMZ and from the DMZ to the WAN.
Apply	Click Apply to save your changes back to the ZyWALL.
Reset	Click Reset to begin configuring this screen afresh.

8.3 Configuring IP Alias

IP alias allows you to partition a physical network into different logical networks over the same Ethernet interface. The ZyWALL supports three logical DMZ interfaces via its single physical Ethernet interface with the ZyWALL itself as the gateway for each DMZ network.

The IP alias IP addresses can be either private or public regardless of whether the physical DMZ interface is set to use a private or public IP address. Use NAT if you want to make DMZ computers with private IP addresses publicly accessible (see [Chapter 17 on page 297](#) for more information). When you use IP alias, you can have the DMZ use both public and private IP addresses at the same time.

Note: Make sure that the subnets of the logical networks do not overlap.

To change your ZyWALL's IP alias settings, click **DMZ**, then the **IP Alias** tab. The screen appears as shown.

Figure 58 DMZ: IP Alias

The screenshot shows the 'DMZ' configuration page with the 'IP Alias' tab selected. It contains two sections for IP Aliases:

- IP Alias 1:**
 - Enable IP Alias 1
 - IP Address: 10 . 0 . 0 . 1
 - IP Subnet Mask: 255 . 0 . 0 . 0
 - RIP Direction: None
 - RIP Version: RIP-1
- IP Alias 2:**
 - Enable IP Alias 2
 - IP Address: 0 . 0 . 0 . 0
 - IP Subnet Mask: 0 . 0 . 0 . 0
 - RIP Direction: None
 - RIP Version: RIP-1

At the bottom of the form are 'Apply' and 'Reset' buttons.

The following table describes the labels in this screen.

Table 49 DMZ: IP Alias

LABEL	DESCRIPTION
Enable IP Alias 1, 2	Select the check box to configure another DMZ network for the ZyWALL.
IP Address	Enter the IP address of your ZyWALL in dotted decimal notation. Note: Make sure the IP addresses of the LAN, WAN and DMZ are on separate subnets.
IP Subnet Mask	Your ZyWALL will automatically calculate the subnet mask based on the IP address that you assign. Unless you are implementing subnetting, use the subnet mask computed by the ZyWALL.
RIP Direction	RIP (Routing Information Protocol, RFC1058 and RFC 1389) allows a router to exchange routing information with other routers. The RIP Direction field controls the sending and receiving of RIP packets. Select the RIP direction from Both/In Only/Out Only/None . When set to Both or Out Only , the ZyWALL will broadcast its routing table periodically. When set to Both or In Only , it will incorporate the RIP information that it receives; when set to None , it will not send any RIP packets and will ignore any RIP packets received.
RIP Version	The RIP Version field controls the format and the broadcasting method of the RIP packets that the ZyWALL sends (it recognizes both formats when receiving). RIP-1 is universally supported but RIP-2 carries more information. RIP-1 is probably adequate for most networks, unless you have an unusual network topology. Both RIP-2B and RIP-2M sends the routing data in RIP-2 format; the difference being that RIP-2B uses subnet broadcasting while RIP-2M uses multicasting. Multicasting can reduce the load on non-router machines since they generally do not listen to the RIP multicast address and so will not receive the RIP packets. However, if one router uses multicasting, then all routers on your network must use multicasting, also. By default, RIP direction is set to Both and the Version set to RIP-1 .

Table 49 DMZ: IP Alias (continued)

LABEL	DESCRIPTION
Apply	Click Apply to save your changes back to the ZyWALL.
Reset	Click Reset to begin configuring this screen afresh.

8.4 DMZ Public IP Address Example

The following figure shows a simple network setup with public IP addresses on the WAN and DMZ and private IP addresses on the LAN. Lower case letters represent public IP addresses (like a.b.c.d for example). The LAN port and connected computers (A through C) use private IP addresses that are in one subnet. The DMZ port and connected servers (D through F) use public IP addresses that are in another subnet. The public IP addresses of the DMZ and WAN ports are in separate subnets.

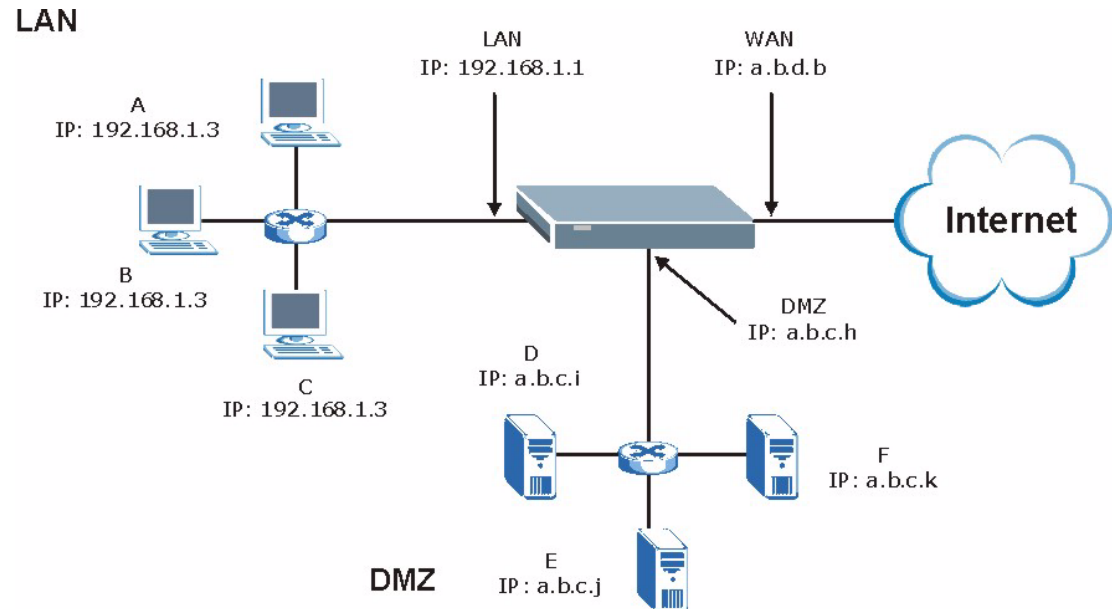
Figure 59 DMZ Public Address Example

8.5 DMZ Private and Public IP Address Example

The following figure shows a network setup with both private and public IP addresses on the DMZ. Lower case letters represent public IP addresses (like a.b.c.d for example). The LAN port and connected computers (A through C) use private IP addresses that are in one subnet. The DMZ port and server F use private IP addresses that are in one subnet. The private IP addresses of the LAN and DMZ are on separate subnets. The DMZ port and connected servers (D and E) use public IP addresses that are in one subnet. The public IP addresses of the DMZ and WAN are on separate subnets.

Configure both DMZ and DMZ IP alias to use this kind of network setup. You also need to configure NAT for the private DMZ IP addresses.

Figure 60 DMZ Private and Public Address Example

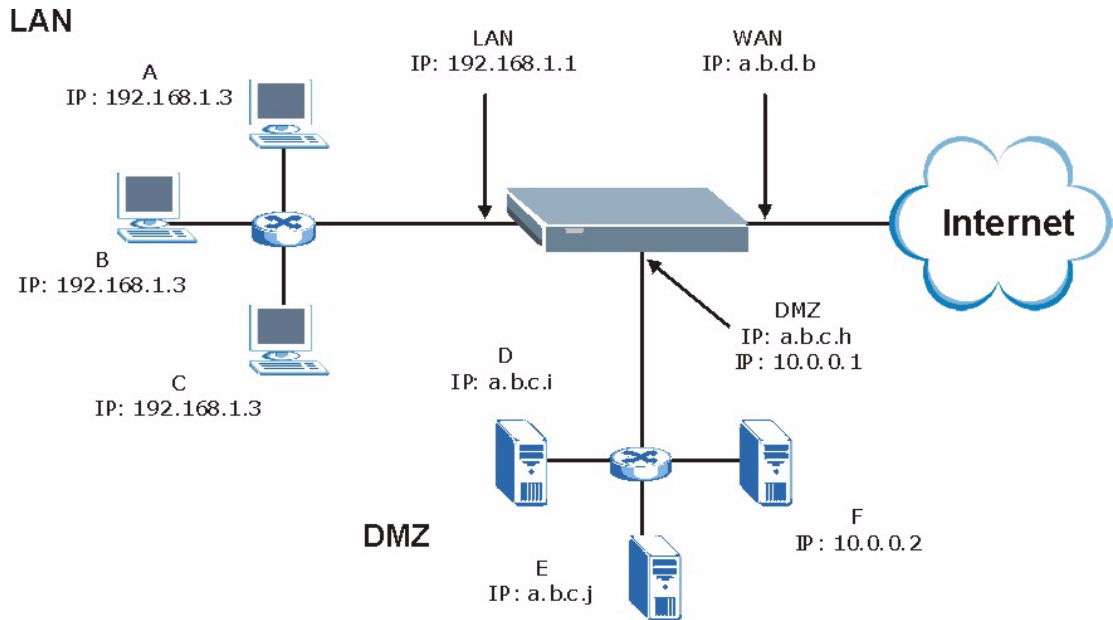

CHAPTER 9

Firewalls

This chapter gives some background information on firewalls and introduces the ZyWALL firewall.

9.1 Firewall Overview

Originally, the term *firewall* referred to a construction technique designed to prevent the spread of fire from one room to another. The networking term firewall is a system or group of systems that enforces an access-control policy between two networks. It may also be defined as a mechanism used to protect a trusted network from an untrusted network. Of course, firewalls cannot solve every security problem. A firewall is *one* of the mechanisms used to establish a network security perimeter in support of a network security policy. It should never be the *only* mechanism or method employed. For a firewall to guard effectively, you must design and deploy it appropriately. This requires integrating the firewall into a broad information-security policy. In addition, specific policies must be implemented within the firewall itself.

9.2 Types of Firewalls

There are three main types of firewalls:

- 1 Packet Filtering Firewalls
- 2 Application-level Firewalls
- 3 Stateful Inspection Firewalls

9.2.1 Packet Filtering Firewalls

Packet filtering firewalls restrict access based on the source/destination computer network address of a packet and the type of application.

9.2.2 Application-level Firewalls

Application-level firewalls restrict access by serving as proxies for external servers. Since they use programs written for specific Internet services, such as HTTP, FTP and telnet, they can evaluate network packets for valid application-specific data. Application-level gateways have a number of general advantages over the default mode of permitting application traffic directly to internal hosts:

- 1 Information hiding prevents the names of internal systems from being made known via DNS to outside systems, since the application gateway is the only host whose name must be made known to outside systems.
- 2 Robust authentication and logging pre-authenticates application traffic before it reaches internal hosts and causes it to be logged more effectively than if it were logged with standard host logging. Filtering rules at the packet filtering router can be less complex than they would be if the router needed to filter application traffic and direct it to a number of specific systems. The router need only allow application traffic destined for the application gateway and reject the rest.

9.2.3 Stateful Inspection Firewalls

Stateful inspection firewalls restrict access by screening data packets against defined access rules. They make access control decisions based on IP address and protocol. They also "inspect" the session data to assure the integrity of the connection and to adapt to dynamic protocols. These firewalls generally provide the best speed and transparency; however, they may lack the granular application level access control or caching that some proxies support. See [Section 9.5 on page 173](#) for more information on Stateful Inspection.

Firewalls, of one type or another, have become an integral part of standard security solutions for enterprises.

9.3 Introduction to ZyXEL's Firewall

The ZyWALL firewall is a stateful inspection firewall and is designed to protect against Denial of Service attacks when activated (in SMT menu 21.2 or in the web configurator). The ZyWALL's purpose is to allow a private Local Area Network (LAN) to be securely connected to the Internet. The ZyWALL can be used to prevent theft, destruction and modification of data, as well as log events, which may be important to the security of your network. The ZyWALL also has packet-filtering capabilities.

The ZyWALL is installed between the LAN and a broadband modem connecting to the Internet. This allows it to act as a secure gateway for all data passing between the Internet and the LAN.

The ZyWALL allows you to physically separate the network into the following areas:

- The WAN (Wide Area Network) port(s) attaches to the broadband modem (cable or ADSL) connecting to the Internet.
- The LAN (Local Area Network) port(s) attaches to a network of computers, which needs security from the outside world. These computers will have access to Internet services such as e-mail, FTP, and the World Wide Web. However, inbound access will not be allowed unless the remote host is authorized to use a specific service.

Figure 61 ZyWALL Firewall Application

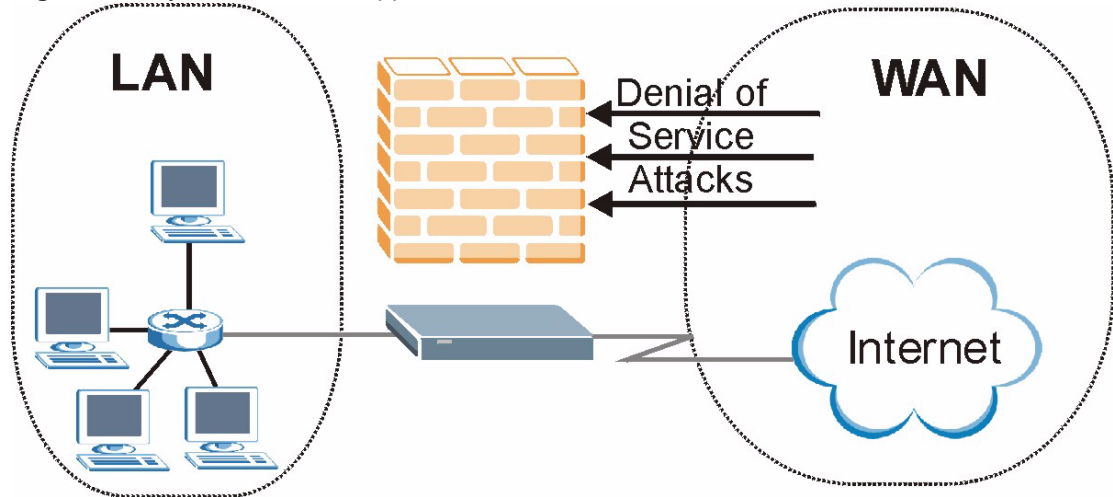

9.4 Denial of Service

Denials of Service (DoS) attacks are aimed at devices and networks with a connection to the Internet. Their goal is not to steal information, but to disable a device or network so users no longer have access to network resources. The ZyWALL is pre-configured to automatically detect and thwart all known DoS attacks.

9.4.1 Basics

Computers share information over the Internet using a common language called TCP/IP. TCP/IP, in turn, is a set of application protocols that perform specific functions. An extension number, called the "TCP port" or "UDP port" identifies these protocols, such as HTTP (Web), FTP (File Transfer Protocol), POP3 (E-mail), etc. For example, Web traffic by default uses TCP port 80.

When computers communicate on the Internet, they are using the client/server model, where the server "listens" on a specific TCP/UDP port for information requests from remote client computers on the network. For example, a Web server typically listens on port 80. Please note that while a computer may be intended for use over a single port, such as Web on port 80, other ports are also active. If the person configuring or managing the computer is not careful, a hacker could attack it over an unprotected port.

Some of the most common IP ports are:

Table 50 Common IP Ports

21	FTP	53	DNS
23	Telnet	80	HTTP
25	SMTP	110	POP3

9.4.2 Types of DoS Attacks

There are four types of DoS attacks:

- 1 Those that exploit bugs in a TCP/IP implementation.
 - 2 Those that exploit weaknesses in the TCP/IP specification.
 - 3 Brute-force attacks that flood a network with useless data.
 - 4 IP Spoofing.
- **"Ping of Death"** and **"Teardrop"** attacks exploit bugs in the TCP/IP implementations of various computer and host systems.
 - a Ping of Death uses a "ping" utility to create an IP packet that exceeds the maximum 65,536 bytes of data allowed by the IP specification. The oversize packet is then sent to an unsuspecting system. Systems may crash, hang or reboot.
 - b Teardrop attack exploits weaknesses in the reassembly of IP packet fragments. As data is transmitted through a network, IP packets are often broken up into smaller chunks. Each fragment looks like the original IP packet except that it contains an offset field that says, for instance, "This fragment is carrying bytes 200 through 400 of the original (non fragmented) IP packet." The Teardrop program creates a series of IP fragments with overlapping offset fields. When these fragments are reassembled at the destination, some systems will crash, hang, or reboot.
 - Weaknesses in the TCP/IP specification leave it open to **"SYN Flood"** and **"LAND"** attacks. These attacks are executed during the handshake that initiates a communication session between two applications.

Figure 62 Three-Way Handshake

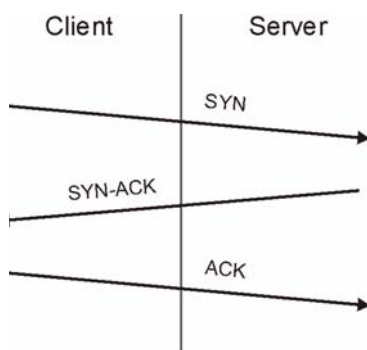

Under normal circumstances, the application that initiates a session sends a SYN (synchronize) packet to the receiving server. The receiver sends back an ACK (acknowledgment) packet and its own SYN, and then the initiator responds with an ACK (acknowledgment). After this handshake, a connection is established.

- a **SYN Attack** floods a targeted system with a series of SYN packets. Each packet causes the targeted system to issue a SYN-ACK

response. While the targeted system waits for the ACK that follows the SYN-ACK, it queues up all outstanding SYN-ACK responses on what is known as a backlog queue. SYN-ACKs are moved off the queue only when an ACK comes back or when an internal timer (which is set at relatively long intervals) terminates the three-way handshake. Once the queue is full, the system will ignore all incoming SYN requests, making the system unavailable for legitimate users.

Figure 63 SYN Flood

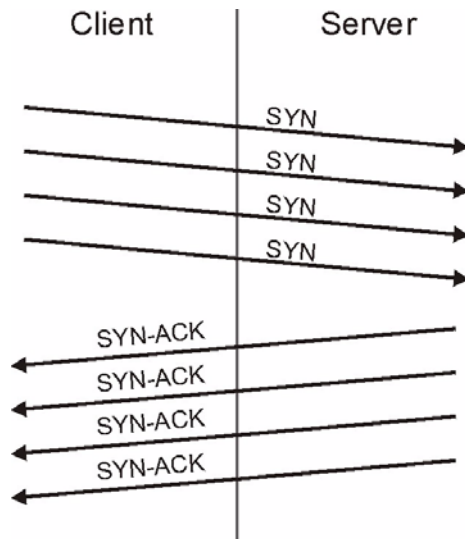

- b** In a **LAND Attack**, hackers flood SYN packets into the network with a spoofed source IP address of the targeted system. This makes it appear as if the host computer sent the packets to itself, making the system unavailable while the target system tries to respond to itself.
- A **brute-force** attack, such as a "Smurf" attack, targets a feature in the IP specification known as directed or subnet broadcasting, to quickly flood the target network with useless data. A Smurf hacker floods a router with Internet Control Message Protocol (ICMP) echo request packets (pings). Since the destination IP address of each packet is the broadcast address of the network, the router will broadcast the ICMP echo request packet to all hosts on the network. If there are numerous hosts, this will create a large amount of ICMP echo request and response traffic. If a hacker chooses to spoof the source IP address of the ICMP echo request packet, the resulting ICMP traffic will not only clog up the "intermediary" network, but will also congest the network of the spoofed source IP address, known as the "victim" network. This flood of broadcast traffic consumes all available bandwidth, making communications impossible.

Figure 64 Smurf Attack

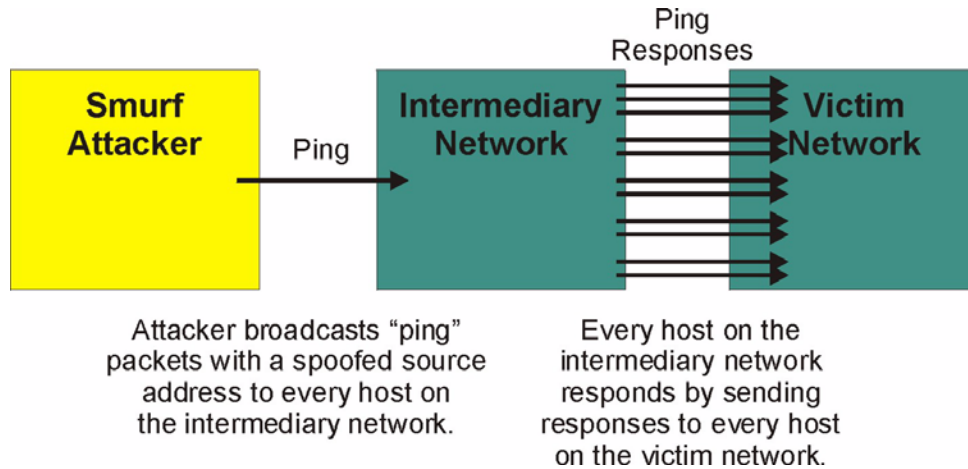

9.4.2.1 ICMP Vulnerability

ICMP is an error-reporting protocol that works in concert with IP. The following ICMP types trigger an alert:

Table 51 ICMP Commands That Trigger Alerts

5	REDIRECT
13	TIMESTAMP_REQUEST
14	TIMESTAMP_REPLY
17	ADDRESS_MASK_REQUEST
18	ADDRESS_MASK_REPLY

9.4.2.2 Illegal Commands (NetBIOS and SMTP)

The only legal NetBIOS commands are the following - all others are illegal.

Table 52 Legal NetBIOS Commands

MESSAGE:
REQUEST:
POSITIVE:
NEGATIVE:
RETARGET:
KEEPALIVE:

All SMTP commands are illegal except for those displayed in the following tables.

Table 53 Legal SMTP Commands

AUTH	DATA	EHLO	ETRN	EXPN	HELO	HELP	MAIL	NOOP
QUIT	RCPT	RSET	SAML	SEND	SOML	TURN	VERFY	

9.4.2.3 Traceroute

Traceroute is a utility used to determine the path a packet takes between two endpoints. Sometimes when a packet filter firewall is configured incorrectly an attacker can traceroute the firewall gaining knowledge of the network topology inside the firewall.

Often, many DoS attacks also employ a technique known as "**IP Spoofing**" as part of their attack. IP Spoofing may be used to break into systems, to hide the hacker's identity, or to magnify the effect of the DoS attack. IP Spoofing is a technique used to gain unauthorized access to computers by tricking a router or firewall into thinking that the communications are coming from within the trusted network. To engage in IP spoofing, a hacker must modify the packet headers so that it appears that the packets originate from a trusted host and should be allowed through the router or firewall. The ZyWALL blocks all IP Spoofing attempts.

9.5 Stateful Inspection

With stateful inspection, fields of the packets are compared to packets that are already known to be trusted. For example, if you access some outside service, the proxy server remembers things about your original request, like the port number and source and destination addresses. This remembering is called *saving the state*. When the outside system responds to your request, the firewall compares the received packets with the saved state to determine if they are allowed in. The ZyWALL uses stateful packet inspection to protect the private LAN from hackers and vandals on the Internet. By default, the ZyWALL's stateful inspection allows all communications to the Internet that originate from the LAN, and blocks all traffic to the LAN that originates from the Internet. In summary, stateful inspection:

- Allows all sessions originating from the LAN (local network) to the WAN (Internet).
- Denies all sessions originating from the WAN to the LAN.

Figure 65 Stateful Inspection

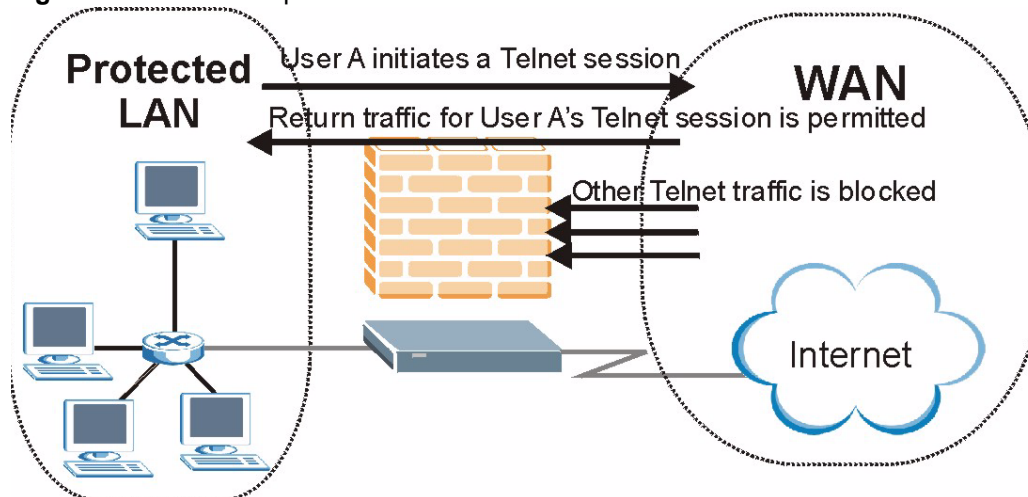

The previous figure shows the ZyWALL's default firewall rules in action as well as demonstrates how stateful inspection works. User A can initiate a Telnet session from within the LAN and responses to this request are allowed. However other Telnet traffic initiated from the WAN is blocked.

9.5.1 Stateful Inspection Process

In this example, the following sequence of events occurs when a TCP packet leaves the LAN network through the firewall's WAN interface. The TCP packet is the first in a session, and the packet's application layer protocol is configured for a firewall rule inspection:

- 1 The packet travels from the firewall's LAN to the WAN.
- 2 The packet is evaluated against the interface's existing outbound access list, and the packet is permitted (a denied packet would simply be dropped at this point).
- 3 The firewall inspects packets to determine and record information about the state of the packet's connection. This information is recorded in a new state table entry created for the new connection. If there is not a firewall rule for this packet and it is not an attack, then the setting in the **Firewall Default Rule** screen determines the action for this packet.
- 4 Based on the obtained state information, a firewall rule creates a temporary access list entry that is inserted at the beginning of the WAN interface's inbound extended access list. This temporary access list entry is designed to permit inbound packets of the same connection as the outbound packet just inspected.
- 5 The outbound packet is forwarded out through the interface.
- 6 Later, an inbound packet reaches the interface. This packet is part of the connection previously established with the outbound packet. The inbound packet is evaluated against the inbound access list, and is permitted because of the temporary access list entry previously created.
- 7 The packet is inspected by a firewall rule, and the connection's state table entry is updated as necessary. Based on the updated state information, the inbound extended access list

temporary entries might be modified, in order to permit only packets that are valid for the current state of the connection.

- 8 Any additional inbound or outbound packets that belong to the connection are inspected to update the state table entry and to modify the temporary inbound access list entries as required, and are forwarded through the interface.
- 9 When the connection terminates or times out, the connection's state table entry is deleted and the connection's temporary inbound access list entries are deleted.

9.5.2 Stateful Inspection and the ZyWALL

Additional rules may be defined to extend or override the default rules. For example, a rule may be created which will:

- 1 Block all traffic of a certain type, such as IRC (Internet Relay Chat), from the LAN to the Internet.
- 2 Allow certain types of traffic from the Internet to specific hosts on the LAN.
- 3 Allow access to a Web server to everyone but competitors.
- 4 Restrict use of certain protocols, such as Telnet, to authorized users on the LAN.

These custom rules work by evaluating the network traffic's Source IP address, Destination IP address, IP protocol type, and comparing these to rules set by the administrator.

Note: The ability to define firewall rules is a very powerful tool. Using custom rules, it is possible to disable all firewall protection or block all access to the Internet. Use extreme caution when creating or deleting firewall rules. Test changes after creating them to make sure they work correctly.

Below is a brief technical description of how these connections are tracked. Connections may either be defined by the upper protocols (for instance, TCP), or by the ZyWALL itself (as with the "virtual connections" created for UDP and ICMP).

9.5.3 TCP Security

The ZyWALL uses state information embedded in TCP packets. The first packet of any new connection has its SYN flag set and its ACK flag cleared; these are "initiation" packets. All packets that do not have this flag structure are called "subsequent" packets, since they represent data that occurs later in the TCP stream.

If an initiation packet originates on the WAN, this means that someone is trying to make a connection from the Internet into the LAN. Except in a few special cases (see "Upper Layer Protocols" shown next), these packets are dropped and logged.

If an initiation packet originates on the LAN, this means that someone is trying to make a connection from the LAN to the Internet. Assuming that this is an acceptable part of the security policy (as is the case with the default policy), the connection will be allowed. A cache entry is added which includes connection information such as IP addresses, TCP ports, sequence numbers, etc.

When the ZyWALL receives any subsequent packet (from the Internet or from the LAN), its connection information is extracted and checked against the cache. A packet is only allowed to pass through if it corresponds to a valid connection (that is, if it is a response to a connection which originated on the LAN).

9.5.4 UDP/ICMP Security

UDP and ICMP do not themselves contain any connection information (such as sequence numbers). However, at the very minimum, they contain an IP address pair (source and destination). UDP also contains port pairs, and ICMP has type and code information. All of this data can be analyzed in order to build "virtual connections" in the cache.

For instance, any UDP packet that originates on the LAN will create a cache entry. Its IP address and port pairs will be stored. For a short period of time, UDP packets from the WAN that have matching IP and UDP information will be allowed back in through the firewall.

A similar situation exists for ICMP, except that the ZyWALL is even more restrictive. Specifically, only outgoing echoes will allow incoming echo replies, outgoing address mask requests will allow incoming address mask replies, and outgoing timestamp requests will allow incoming timestamp replies. No other ICMP packets are allowed in through the firewall, simply because they are too dangerous and contain too little tracking information. For instance, ICMP redirect packets are never allowed in, since they could be used to reroute traffic through attacking machines.

9.5.5 Upper Layer Protocols

Some higher layer protocols (such as FTP and RealAudio) utilize multiple network connections simultaneously. In general terms, they usually have a "control connection" which is used for sending commands between endpoints, and then "data connections" which are used for transmitting bulk information.

Consider the FTP protocol. A user on the LAN opens a control connection to a server on the Internet and requests a file. At this point, the remote server will open a data connection from the Internet. For FTP to work properly, this connection must be allowed to pass through even though a connection from the Internet would normally be rejected.

In order to achieve this, the ZyWALL inspects the application-level FTP data. Specifically, it searches for outgoing "PORT" commands, and when it sees these; it adds a cache entry for the anticipated data connection. This can be done safely, since the PORT command contains address and port information, which can be used to uniquely identify the connection.

Any protocol that operates in this way must be supported on a case-by-case basis. You can use the web configurator's **Custom Services** feature to do this.

9.6 Guidelines For Enhancing Security With Your Firewall

- 1 Change the default password via SMT or web configurator.
- 2 Think about access control before you connect a console port to the network in any way, including attaching a modem to the port. Be aware that a break on the console port might give unauthorized individuals total control of the firewall, even with access control configured.
- 3 Limit who can telnet into your router.
- 4 Don't enable any local service (such as SNMP or NTP) that you don't use. Any enabled service could present a potential security risk. A determined hacker might be able to find creative ways to misuse the enabled services to access the firewall or the network.
- 5 For local services that are enabled, protect against misuse. Protect by configuring the services to communicate only with specific peers, and protect by configuring rules to block packets for the services at specific interfaces.
- 6 Protect against IP spoofing by making sure the firewall is active.
- 7 Keep the firewall in a secured (locked) room.

9.7 Packet Filtering Vs Firewall

Below are some comparisons between the ZyWALL's filtering and firewall functions.

9.7.1 Packet Filtering:

- The router filters packets as they pass through the router's interface according to the filter rules you designed.
- Packet filtering is a powerful tool, yet can be complex to configure and maintain, especially if you need a chain of rules to filter a service.
- Packet filtering only checks the header portion of an IP packet.

9.7.1.1 When To Use Filtering

- 1 To block/allow LAN packets by their MAC addresses.
- 2 To block/allow special IP packets which are neither TCP nor UDP, nor ICMP packets.
- 3 To block/allow both inbound (WAN to LAN) and outbound (LAN to WAN) traffic between the specific inside host/network "A" and outside host/network "B". If the filter blocks the traffic from A to B, it also blocks the traffic from B to A. Filters cannot distinguish traffic originating from an inside host or an outside host by IP address.
- 4 To block/allow IP trace route.

9.7.2 Firewall

- The firewall inspects packet contents as well as their source and destination addresses. Firewalls of this type employ an inspection module, applicable to all protocols, that understands data in the packet is intended for other layers, from the network layer (IP headers) up to the application layer.
- The firewall performs stateful inspection. It takes into account the state of connections it handles so that, for example, a legitimate incoming packet can be matched with the outbound request for that packet and allowed in. Conversely, an incoming packet masquerading as a response to a nonexistent outbound request can be blocked.
- The firewall uses session filtering, i.e., smart rules, that enhance the filtering process and control the network session rather than control individual packets in a session.
- The firewall provides e-mail service to notify you of routine reports and when alerts occur.

9.7.2.1 When To Use The Firewall

- 1** To prevent DoS attacks and prevent hackers cracking your network.
- 2** A range of source and destination IP addresses as well as port numbers can be specified within one firewall rule making the firewall a better choice when complex rules are required.
- 3** To selectively block/allow inbound or outbound traffic between inside host/networks and outside host/networks. Remember that filters cannot distinguish traffic originating from an inside host or an outside host by IP address.
- 4** The firewall performs better than filtering if you need to check many rules.
- 5** Use the firewall if you need routine e-mail reports about your system or need to be alerted when attacks occur.
- 6** The firewall can block specific URL traffic that might occur in the future. The URL can be saved in an Access Control List (ACL) database.

CHAPTER 10

Firewall Screens

This chapter shows you how to configure your ZyWALL firewall.

10.1 Access Methods

The web configurator is, by far, the most comprehensive firewall configuration tool your ZyWALL has to offer. For this reason, it is recommended that you configure your firewall using the web configurator. SMT screens allow you to activate the firewall. CLI commands provide limited configuration options and are only recommended for advanced users, please refer to [Appendix M on page 659](#) for firewall CLI commands.

10.2 Firewall Policies Overview

Firewall rules are grouped based on the direction of travel of packets to which they apply:

- LAN to LAN/ZyWALL
- LAN to WAN
- LAN to DMZ
- WAN to LAN
- WAN to WAN/ZyWALL
- WAN to DMZ
- DMZ to LAN
- DMZ to WAN
- DMZ to DMZ/ZyWALL

Note: The LAN includes both the LAN port and the WLAN.

By default, the ZyWALL's stateful packet inspection allows packets traveling in the following directions:

- LAN to LAN/ZyWALL
This allows computers on the LAN to manage the ZyWALL and communicate between networks or subnets connected to the LAN interface.
- LAN to WAN
- LAN to DMZ
- WAN to DMZ
- DMZ to WAN

By default, the ZyWALL's stateful packet inspection blocks packets traveling in the following directions:

- WAN to LAN
- WAN to WAN/ZyWALL

This prevents computers on the WAN from using the ZyWALL as a gateway to communicate with other computers on the WAN and/or managing the ZyWALL.

- DMZ to LAN
- DMZ to DMZ/ZyWALL

This prevents computers on the DMZ from communicating between networks or subnets connected to the DMZ interface and/or managing the ZyWALL.

You may define additional rules and sets or modify existing ones but please exercise extreme caution in doing so.

Note: If you configure firewall rules without a good understanding of how they work, you might inadvertently introduce security risks to the firewall and to the protected network. Make sure you test your rules after you configure them.

For example, you may create rules to:

- Block certain types of traffic, such as IRC (Internet Relay Chat), from the LAN to the Internet.
- Allow certain types of traffic, such as Lotus Notes database synchronization, from specific hosts on the Internet to specific hosts on the LAN.
- Allow everyone except your competitors to access a Web server.
- Restrict use of certain protocols, such as Telnet, to authorized users on the LAN.

These custom rules work by comparing the Source IP address, Destination IP address and IP protocol type of network traffic to rules set by the administrator. Your customized rules take precedence and override the ZyWALL's default rules.

10.3 Rule Logic Overview

Note: Study these points carefully before configuring rules.

10.3.1 Rule Checklist

- 1 State the intent of the rule. For example, This restricts all IRC access from the LAN to the Internet. Or, This allows a remote Lotus Notes server to synchronize over the Internet to an inside Notes server.
- 2 Is the intent of the rule to forward or block traffic?
- 3 What direction of traffic does the rule apply to (see [Section 9.2 on page 167](#))?
- 4 What IP services will be affected?
- 5 What computers on the LAN or DMZ are to be affected (if any)?
- 6 What computers on the Internet will be affected? The more specific, the better. For example, if traffic is being allowed from the Internet to the LAN, it is better to allow only certain machines on the Internet to access the LAN.

10.3.2 Security Ramifications

Once the logic of the rule has been defined, it is critical to consider the security ramifications created by the rule:

- 1 Does this rule stop LAN users from accessing critical resources on the Internet? For example, if IRC is blocked, are there users that require this service?
- 2 Is it possible to modify the rule to be more specific? For example, if IRC is blocked for all users, will a rule that blocks just certain users be more effective?
- 3 Does a rule that allows Internet users access to resources on the LAN create a security vulnerability? For example, if FTP ports (TCP 20, 21) are allowed from the Internet to the LAN, Internet users may be able to connect to computers with running FTP servers.
- 4 Does this rule conflict with any existing rules?

Once these questions have been answered, adding rules is simply a matter of plugging the information into the correct fields in the web configurator screens.

10.3.3 Key Fields For Configuring Rules

10.3.3.1 Action

Should the action be to **Block** or **Forward**?

Note: “Block” means the firewall silently discards the packet.

10.3.3.2 Service

Select the service from the **Service** scrolling list box. If the service is not listed, it is necessary to first define it. See [Section 10.8 on page 194](#) for more information on predefined services.

10.3.3.3 Source Address

What is the connection's source address; is it on the LAN, DMZ or WAN? Is it a single IP, a range of IPs or a subnet?

10.3.3.4 Destination Address

What is the connection's destination address; is it on the LAN, DMZ or WAN? Is it a single IP, a range of IPs or a subnet?

10.4 Connection Direction Examples

This section describes examples for firewall rules for connections going from LAN to WAN and from WAN to LAN. Rules for the DMZ work in a similar fashion.

LAN to LAN/ZyWALL, WAN to WAN/ZyWALL and DMZ to DMZ/ZyWALL rules apply to packets coming in on the associated interface (LAN, WAN, or DMZ respectively). LAN to LAN/ZyWALL means policies for LAN-to-ZyWALL (the policies for managing the ZyWALL through the LAN interface) and policies for LAN-to-LAN (the policies that control routing between two subnets on the LAN). Similarly, WAN to WAN/ZyWALL and DMZ to DMZ/ZyWALL polices apply in the same way to the WAN and DMZ ports.

10.4.1 LAN To WAN Rules

The default rule for LAN to WAN traffic is that all users on the LAN are allowed non-restricted access to the WAN. When you configure a LAN to WAN rule, you in essence want to limit some or all users from accessing certain services on the WAN. See the following figure.

Figure 66 LAN to WAN Traffic

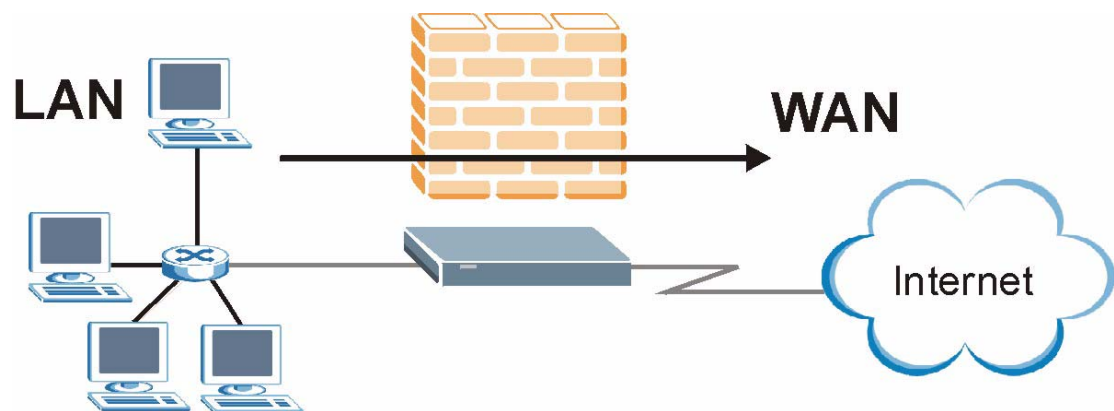

10.4.2 WAN To LAN Rules

The default rule for WAN to LAN traffic blocks all incoming connections (WAN to LAN). If you wish to allow certain WAN users to have access to your LAN, you will need to create custom rules to allow it.

See the following figure.

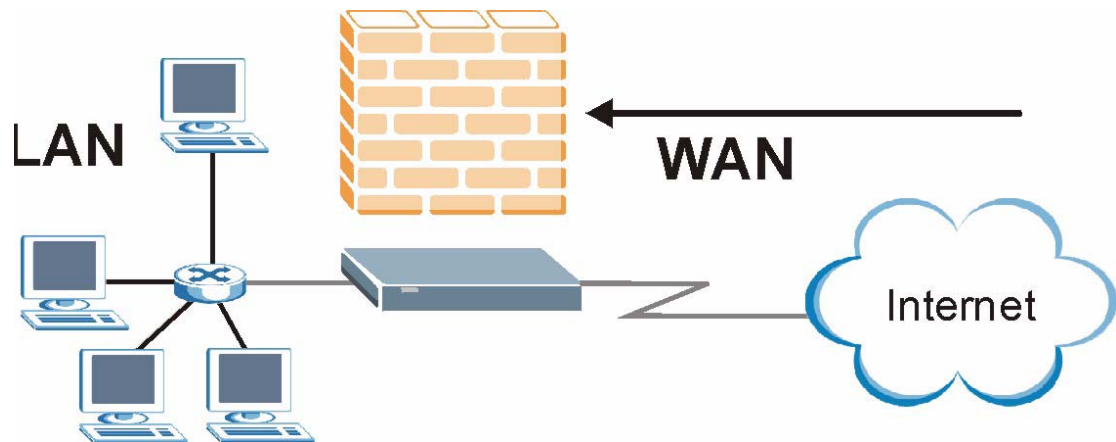
Figure 67 WAN to LAN Traffic

10.5 Alerts

Alerts are reports on events, such as attacks, that you may want to know about right away. You can choose to generate an alert when a rule is matched in the **Edit Rule** screen (see [Figure 71 on page 188](#)). Configure the **Log Settings** screen to have the ZyWALL send an immediate e-mail message to you when an event generates an alert. Refer to the chapter on logs for details.

10.6 Configuring Firewall

Click **FIREWALL** to open the **Default Rule** screen. Enable (or activate) the firewall by selecting the **Enable Firewall** check box as seen in the following screen.

Figure 68 Default Rule (Router Mode)

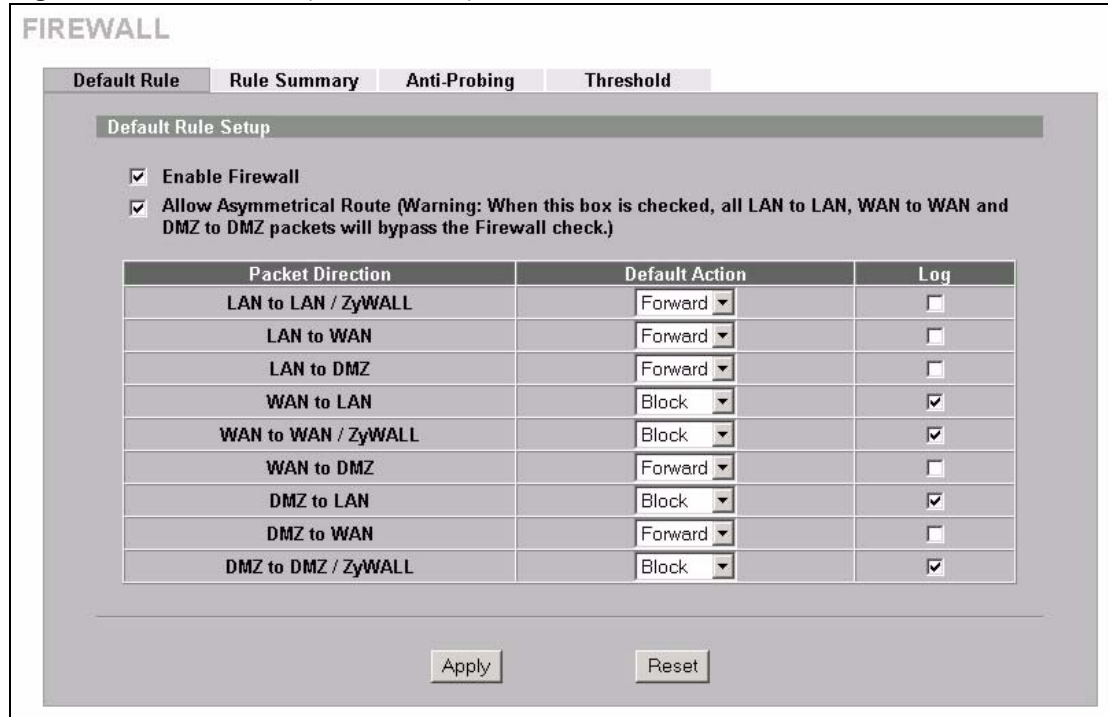

The following table describes the labels in this screen.

Table 54 Default Rule (Router Mode)

LABEL	DESCRIPTION
Enable Firewall	Select this check box to activate the firewall. The ZyWALL performs access control and protects against Denial of Service (DoS) attacks when the firewall is activated.
Allow Asymmetrical Route	Select this check box to have the ZyWALL firewall permit the use of triangle route topology on the network. Note: Allowing asymmetrical routes may let traffic from the WAN go directly to a LAN computer without passing through the ZyWALL. See Appendix H on page 623 for more on triangle route topology and how to deal with this problem.
Packet Direction	This is the direction of travel of packets (LAN to LAN/ZyWALL, LAN to WAN, LAN to DMZ, WAN to LAN, WAN to WAN/ZyWALL, WAN to DMZ, DMZ to LAN, DMZ to WAN or DMZ to DMZ/ZyWALL). Firewall rules are grouped based on the direction of travel of packets to which they apply. For example, LAN to LAN/ZyWALL means packets traveling from a computer/subnet on the LAN to either another computer/subnet on the LAN interface of the ZyWALL or the ZyWALL itself.
Default Action	Use the drop-down list boxes to select whether to Block (silently discard) or Forward (allow the passage of) packets that are traveling in the selected direction.
Log	Select the check box to create a log (when the above action is taken) for packets that are traveling in the selected direction and do not match any of the rules below.
Apply	Click Apply to save your changes back to the ZyWALL.
Reset	Click Reset to begin configuring this screen afresh.

Figure 69 Default Rule (Bridge Mode)

FIREWALL

Default Rule | Rule Summary | Anti-Probing | Threshold

Default Rule Setup

Enable Firewall

Allow Asymmetrical Route (Warning: When this box is checked, all LAN to LAN, WAN to WAN and DMZ to DMZ packets will bypass the Firewall check.)

Packet Direction	Default Action	Log	Log Broadcast Frame
LAN to LAN / ZyWALL	Forward	<input type="checkbox"/>	<input checked="" type="checkbox"/>
LAN to WAN	Forward	<input type="checkbox"/>	<input checked="" type="checkbox"/>
LAN to DMZ	Forward	<input type="checkbox"/>	<input checked="" type="checkbox"/>
WAN to LAN	Block	<input checked="" type="checkbox"/>	<input checked="" type="checkbox"/>
WAN to WAN / ZyWALL	Block	<input checked="" type="checkbox"/>	<input checked="" type="checkbox"/>
WAN to DMZ	Forward	<input type="checkbox"/>	<input checked="" type="checkbox"/>
DMZ to LAN	Block	<input checked="" type="checkbox"/>	<input checked="" type="checkbox"/>
DMZ to WAN	Forward	<input type="checkbox"/>	<input checked="" type="checkbox"/>
DMZ to DMZ / ZyWALL	Block	<input checked="" type="checkbox"/>	<input checked="" type="checkbox"/>

Apply Reset

The following table describes the labels in this screen.

Table 55 Default Rule (Bridge Mode)

LABEL	DESCRIPTION
Enable Firewall	Select this check box to activate the firewall. The ZyWALL performs access control and protects against Denial of Service (DoS) attacks when the firewall is activated.
Allow Asymmetrical Route	Select this check box to have the ZyWALL firewall permit the use of triangle route topology on the network. See Appendix H on page 623 for more on triangle route topology.
Packet Direction	This is the direction of travel of packets (LAN to LAN/ZyWALL, LAN to WAN, LAN to DMZ, WAN to LAN, WAN to WAN/ZyWALL, WAN to DMZ, DMZ to LAN, DMZ to WAN or DMZ to DMZ/ZyWALL). Firewall rules are grouped based on the direction of travel of packets to which they apply. For example, LAN to LAN/ZyWALL means packets traveling from a computer/subnet on the LAN to either another computer/subnet on the LAN interface of the ZyWALL or the ZyWALL itself.
Action	Use the drop-down list boxes to select whether to Block (silently discard) or Forward (allow the passage of) packets that are traveling in the selected direction.
Log	Select the check box to create a log (when the above action is taken) for packets that are traveling in the selected direction and do not match any of the rules below.
Log Broadcast Frame	Select the check box to create a log for any Layer 2 broadcast frames that are traveling in the selected direction.
Apply	Click Apply to save your changes back to the ZyWALL.
Reset	Click Reset to begin configuring this screen afresh.

10.6.1 Rule Summary

Note: The ordering of your rules is very important as rules are applied in turn.

Click **FIREWALL**, then the **Rule Summary** tab to open the screen.

Figure 70 Rule Summary

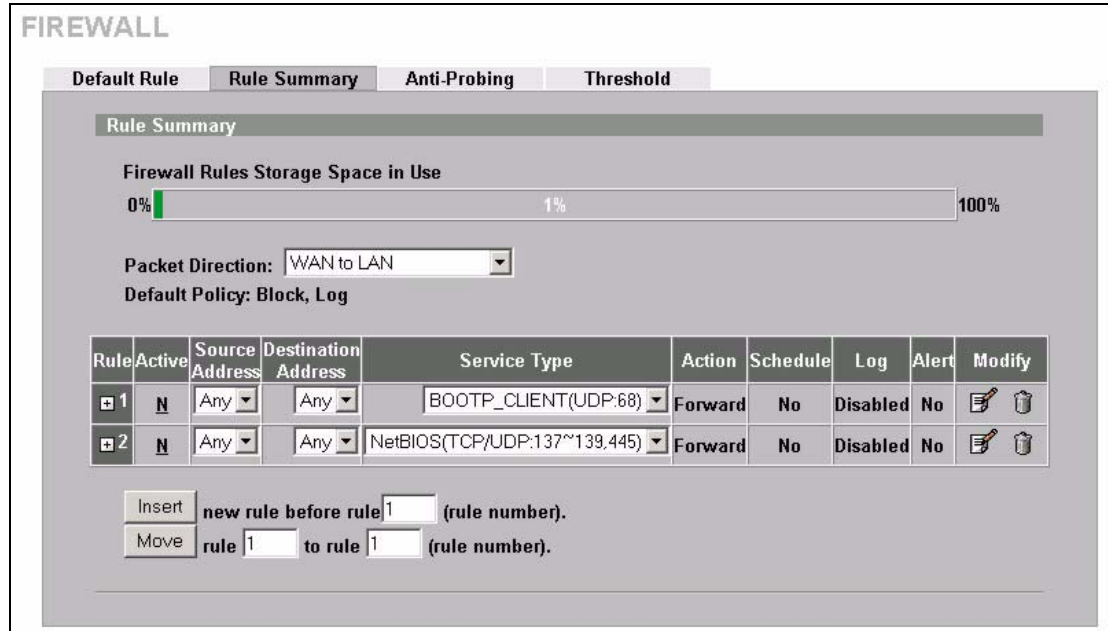

The following table describes the labels in this screen.

Table 56 Rule Summary

LABEL	DESCRIPTION
Firewall Rules Storage Space in Use	This bar displays the percentage of the ZyWALL's firewall rules storage space that is currently in use. The bar turns from green to red when the maximum is being approached. When the bar is red, you should consider deleting unnecessary firewall rules before adding more firewall rules.
Packet Direction	Use the drop-down list box to select a direction of travel of packets (LAN to LAN/ZyWALL, LAN to WAN, LAN to DMZ, WAN to WAN/ZyWALL, WAN to LAN, WAN to DMZ, DMZ to DMZ/ZyWALL, DMZ to LAN or DMZ to WAN) for which you want to configure firewall rules.
Default Policy	This field displays the default action and log policy you selected in the Default Rule screen for the packet direction shown in the field above.
The following read-only fields summarize the rules you have created that apply to traffic traveling in the selected packet direction. The firewall rules that you configure (summarized below) take priority over the general firewall action settings above.	
Rule	This is your firewall rule number. The ordering of your rules is important as rules are applied in turn. Click + to expand or - to collapse the Source Address, Destination Address and Service Type drop down lists.
Active	This field displays whether a firewall is turned on (Y) or not (N).
Source Address	This drop-down list box displays the source addresses or ranges of addresses to which this firewall rule applies. Please note that a blank source or destination address is equivalent to Any .

Table 56 Rule Summary

LABEL	DESCRIPTION
Destination Address	This drop-down list box displays the destination addresses or ranges of addresses to which this firewall rule applies. Please note that a blank source or destination address is equivalent to Any .
Service Type	This drop-down list box displays the services to which this firewall rule applies. Please note that a blank service type is equivalent to Any . See Table 59 on page 194 for more information.
Action	This is the specified action for that rule, either Block or Forward . Note that Block means the firewall silently discards the packet.
Schedule	This field tells you whether a schedule is specified (Yes) or not (No).
Log	This field shows you whether a log is created when packets match this rule (Enabled) or not (Disable).
Alert	This field tells you whether this rule generates an alert (Yes) or not (No) when the rule is matched.
Modify	Click the edit icon to go to the screen where you can edit the rule. Click the delete icon to delete an existing firewall rule. A window display asking you to confirm that you want to delete the firewall rule. Note that subsequent firewall rules move up by one when you take this action.
Insert	Type the index number for where you want to put a rule. For example, if you type 6, your new rule becomes number 6 and the previous rule 6 (if there is one) becomes rule 7. Click Insert to display this screen and refer to the following table for information on the fields.
Move	Type a rule's index number and the number for where you want to put that rule. Click Move to move the rule to the number that you typed. The ordering of your rules is important as they are applied in order of their numbering.

10.6.2 Configuring Firewall Rules

Follow these directions to create a new rule.

- 1** In the **Rule Summary** screen, type the index number for where you want to put the rule. For example, if you type 6, your new rule becomes number 6 and the previous rule 6 (if there is one) becomes rule 7.
- 2** Click **Insert** to display this screen and refer to the following table for information on the labels.

Figure 71 Creating/Editing A Firewall Rule

FIREWALL - EDIT RULE

Edit Source Address

Address Editor

Address Type Any Address

Start IP Address 0 . 0 . 0 . 0

End IP Address 0 . 0 . 0 . 0

Subnet Mask 0 . 0 . 0 . 0

Add Modify

Source Address(es)

Any

Delete

Edit Destination Address

Address Editor

Address Type Any Address

Start IP Address 0 . 0 . 0 . 0

End IP Address 0 . 0 . 0 . 0

Subnet Mask 0 . 0 . 0 . 0

Add Modify

Destination Address(es)

Any

Delete

Edit Service

Available Services

Any(TCP)
 Any(UDP)
 AIM/NEW_ICQ(TCP:5190)
 AUTH(TCP:113)
 BGP(TCP:179)

Custom Service:

Add Edit Delete

Selected Service(s)

<<
>>

Edit Schedule

Day to Apply:

Sun Mon Tue Wed Thu Fri Sat

Time of Day to Apply: (24-Hour Format)

All day

Start: (Hour) (Minute) **End:** (Hour) (Minute)

Actions When Matched

Log Packet Information When Matched

Send Alert Message to Administrator When Matched

Action for Matched Packets Forward

Apply
Cancel

The following table describes the labels in this screen.

Table 57 Creating/Editing A Firewall Rule

LABEL	DESCRIPTION
Edit Source/ Destination Address	
Address Type	Do you want your rule to apply to packets with a particular (single) IP, a range of IP addresses (e.g., 192.168.1.10 to 192.169.1.50), a subnet or any IP address? Select an option from the drop-down list box that includes: Single Address, Range Address, Subnet Address and Any Address .
Start IP Address	Enter the single IP address or the starting IP address in a range here.
End IP Address	Enter the ending IP address in a range here.
Subnet Mask	Enter the subnet mask here, if applicable.
Add	Click Add to add a new address to the Source or Destination Address(es) box. You can add multiple addresses, ranges of addresses, and/or subnets.
Modify	To edit an existing source or destination address, select it from the box and click Modify .
Delete	Highlight an existing source or destination address from the Source or Destination Address(es) box above and click Delete to remove it.
Edit Service	
Available/ Selected Services	Please see Table 59 on page 194 for more information on services available. Highlight a service from the Available Services box on the left, then click >> to add it to the Selected Service(s) box on the right. To remove a service, highlight it in the Selected Service(s) box on the right, then click <<.
Custom Service	
Add	Click this button to bring up the screen that you use to configure a new custom service that is not in the predefined list of services.
Edit	Select a custom service (denoted by an *) from the Available Services list and click this button to edit the service.
Delete	Select a custom service (denoted by an *) from the Available Services list and click this button to remove the service.
Edit Schedule	
Day to Apply	Select everyday or the day(s) of the week to apply the rule.
Time of Day to Apply (24-Hour Format)	Select All Day or enter the start and end times in the hour-minute format to apply the rule.
Actions When Matched	
Log Packet Information When Matched	This field determines if a log for packets that match the rule is created (Enable) or not (Disable). Go to the Log Settings page and select the Access Control logs category to have the ZyWALL record these logs.
Send Alert Message to Administrator When Matched	Select the check box to have the ZyWALL generate an alert when the rule is matched.
Action for Matched Packets	Use the drop-down list box to select whether to discard (Block) or allow the passage of (Forward) packets that match this rule.

Table 57 Creating/Editing A Firewall Rule

LABEL	DESCRIPTION
Apply	Click Apply to save your customized settings and exit this screen.
Cancel	Click Cancel to exit this screen without saving.

10.6.3 Configuring Custom Services

Configure customized ports for services not predefined by the ZyWALL (see [Section 10.8 on page 194](#) for a list of predefined services). For a comprehensive list of port numbers and services, visit the IANA (Internet Assigned Number Authority) web site.

Click the **Add** button under **Custom Service** while editing a firewall rule to configure a custom service. This displays the following screen.

Figure 72 Creating/Editing A Custom Service

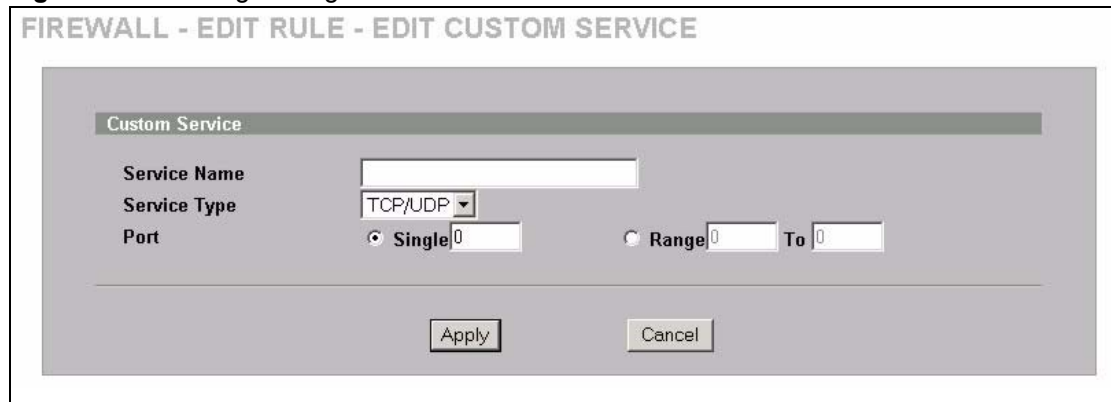

The following table describes the labels in this screen.

Table 58 Creating/Editing A Custom Service

LABEL	DESCRIPTION
Service Name	Enter a unique name for your custom service.
Service Type	Choose the IP port (TCP , UDP or Both) that defines your customized service from the drop down list box.
Port	Select Single to specify one port only or Range to specify a span of ports that define your customized service.
Apply	Click Apply to save your customized settings and exit this screen.
Cancel	Click Cancel to exit this screen without saving.

10.7 Example Firewall Rule

The following Internet firewall rule example allows a hypothetical My Service connection from the Internet.

- 1 Click the **FIREWALL** link and then the **Rule Summary** tab. Select **WAN to LAN** from the **Packet Direction** drop-down list box.

Figure 73 Rule Summary

FIREWALL

Default Rule Rule Summary Anti-Probing Threshold

Rule Summary

Firewall Rules Storage Space in Use

0%

 1% 100%

Packet Direction: WAN to LAN

Default Policy: Block, Log

Rule	Active	Source Address	Destination Address	Service Type	Action	Schedule	Log	Alert	Modify
1	N	Any	Any	BOOTP_CLIENT(UDP:68)	Forward	No	Disabled	No	
2	N	Any	Any	NetBIOS(TCP/UDP:137~139,445)	Forward	No	Disabled	No	

Insert new rule before rule (rule number).

Move rule to rule (rule number).

- 2 In the **Rule Summary** screen, type the index number for where you want to put the rule. For example, if you type 6, your new rule becomes number 6 and the previous rule 6 (if there is one) becomes rule 7.
- 3 Click **Insert** to display the firewall rule configuration screen.
- 4 Select **Any** in the **Destination Address** box and then click **Delete**.
- 5 Configure the destination address screen as follows and click **Add**.

Figure 74 Rule Edit Example

The screenshot shows the 'FIREWALL - EDIT RULE' interface. It is divided into three main sections: 'Edit Source Address', 'Edit Destination Address', and 'Edit Service'. The 'Edit Destination Address' section is highlighted with a red oval. In this section, the 'Address Editor' has 'Address Type' set to 'Range Address'. The 'Start IP Address' is '10 . 0 . 0 . 10', the 'End IP Address' is '10 . 0 . 0 . 15', and the 'Subnet Mask' is '0 . 0 . 0 . 0'. There are 'Add' and 'Modify' buttons below these fields. To the right, the 'Destination Address(es)' field is set to 'Any' with a 'Delete' button below it.

6 In the **Edit Rule** screen, click **Add** under **Custom Service** to open the **Edit Custom Service** screen. Configure it as follows and click **Apply**.

Figure 75 Edit Custom Service Example

The screenshot shows the 'FIREWALL - EDIT RULE - EDIT CUSTOM SERVICE' interface. It has a 'Custom Service' header. The 'Service Name' field contains 'My Service'. The 'Service Type' dropdown is set to 'TCP/UDP'. The 'Port' section has the 'Single' radio button selected with the value '123' in the adjacent input field. The 'Range' radio button is unselected, and its 'To' field is empty. At the bottom, there are 'Apply' and 'Cancel' buttons.

7 In the **Edit Rule** screen, use the arrows between **Available Services** and **Selected Service(s)** to configure it as follows. Click **Apply** when you are done.

Note: Custom services show up with an * before their names in the **Services** list box and the **Rule Summary** list box. Click **Apply** after you've created your custom service.

Figure 76 My Service Rule Configuration

FIREWALL - EDIT RULE

Edit Source Address

Address Editor	Source Address(es)
Address Type Any Address	<div style="border: 1px solid gray; padding: 5px; min-height: 100px;">Any</div>
Start IP Address 0 . 0 . 0 . 0	
End IP Address 0 . 0 . 0 . 0	
Subnet Mask 0 . 0 . 0 . 0	
<input type="button" value="Add"/> <input type="button" value="Modify"/>	
<input type="button" value="Delete"/>	

Edit Destination Address

Address Editor	Destination Address(es)
Address Type Any Address	<div style="border: 1px solid gray; padding: 5px; min-height: 100px;">10.0.0.10-10.0.0.15</div>
Start IP Address 0 . 0 . 0 . 0	
End IP Address 0 . 0 . 0 . 0	
Subnet Mask 0 . 0 . 0 . 0	
<input type="button" value="Add"/> <input type="button" value="Modify"/>	
<input type="button" value="Delete"/>	

Edit Service

Available Services	<<	Selected Service(s)
<div style="border: 1px solid gray; padding: 5px; min-height: 100px;"> Any(TCP) Any(UDP) AIM/NEW_ICQ(TCP:5190) AUTH(TCP:113) BGP(TCP:179) </div>	>>	<div style="border: 1px solid gray; padding: 5px; min-height: 100px;"> *My Service(TCP/UDP:123) </div>
Custom Service:		
<input type="button" value="Add"/> <input type="button" value="Edit"/> <input type="button" value="Delete"/>		

Edit Schedule

Day to Apply:
 Sun Mon Tue Wed Thu Fri Sat

Time of Day to Apply: (24-Hour Format)
 All day

Start: (Hour) (Minute) **End:** (Hour) (Minute)

Actions When Matched

Log Packet Information When Matched

Send Alert Message to Administrator When Matched

Action for Matched Packets Forward

Figure 77 My Service Example Rule Summary

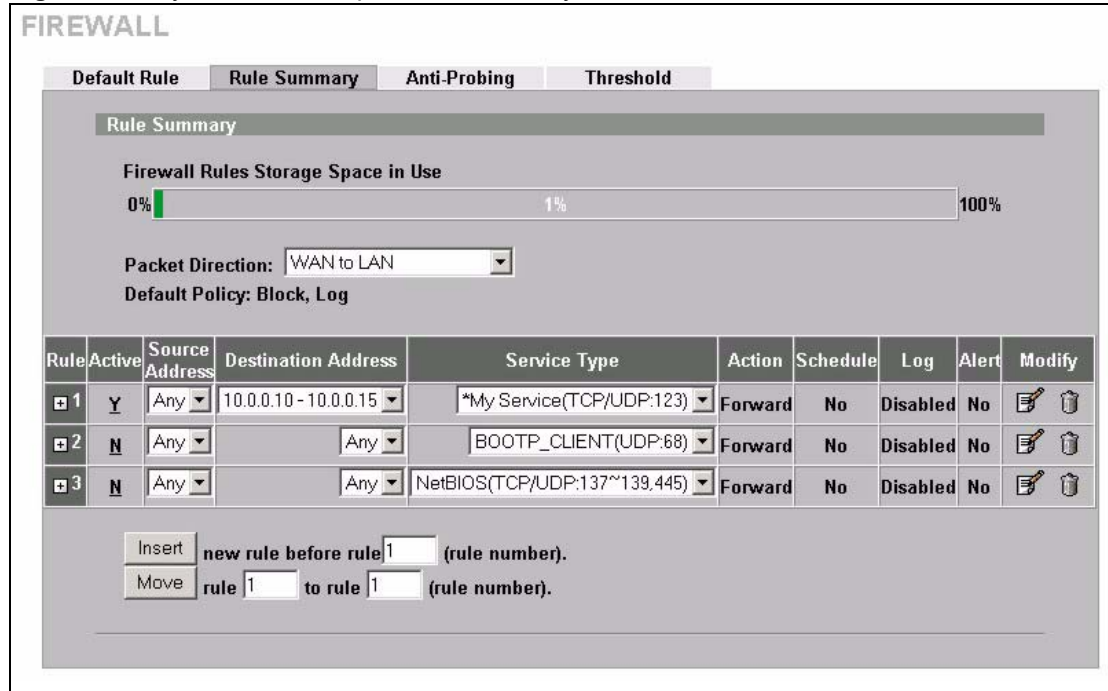

Rule 1: Allows a My Service connection from the WAN to IP addresses 10.0.0.10 through 10.0.0.15 on the LAN.

10.8 Predefined Services

The **Available Services** list box in the **Edit Rule** screen (see [Figure 71 on page 188](#)) displays all predefined services that the ZyWALL already supports. Next to the name of the service, two fields appear in brackets. The first field indicates the IP protocol type (TCP, UDP, or ICMP). The second field indicates the IP port number that defines the service. (Note that there may be more than one IP protocol type. For example, look at the default configuration labeled **(DNS). (UDP/TCP:53)** means UDP port 53 and TCP port 53. Custom services may also be configured using the **Custom Services** function discussed previously.

Table 59 Predefined Services

SERVICE	DESCRIPTION
AIM/New-ICQ(TCP:5190)	AOL's Internet Messenger service, used as a listening port by ICQ.
AUTH(TCP:113)	Authentication protocol used by some servers.
BGP(TCP:179)	Border Gateway Protocol.
BOOTP_CLIENT(UDP:68)	DHCP Client.
BOOTP_SERVER(UDP:67)	DHCP Server.
CU-SEEME (TCP/UDP:7648, 24032)	A popular videoconferencing solution from White Pines Software.
DNS(UDP/TCP:53)	Domain Name Server, a service that matches web names (e.g. www.zyxel.com) to IP numbers.

Table 59 Predefined Services (continued)

SERVICE	DESCRIPTION
FINGER(TCP:79)	Finger is a UNIX or Internet related command that can be used to find out if a user is logged on.
FTP(TCP:20.21)	File Transfer Program, a program to enable fast transfer of files, including large files that may not be possible by e-mail.
H.323(TCP:1720)	NetMeeting uses this protocol.
HTTP(TCP:80)	Hyper Text Transfer Protocol – a client/server protocol for the world wide web.
HTTPS(TCP:443)	HTTPS is a secured http session often used in e-commerce.
ICQ(UDP:4000)	This is a popular Internet chat program.
IKE(UDP:500)	The Internet Key Exchange algorithm is used for key distribution and management.
IP(AX.25:0)	AX.25 (Amateur X.25, an “Amateur” version of X.25) is the communications protocol used for packet radio.
IP(IPv6:0)	IPv6 (Internet Protocol version 6) is a protocol designed by the IETF to replace and solve many problems of the version 4 (IPv4).
IPSEC_TRANSPORT / TUNNEL(AH:0)	The IPSEC AH (Authentication Header) tunneling protocol uses this service.
IPSEC_TUNNEL(ESP:0)	The IPSEC ESP (Encapsulation Security Protocol) tunneling protocol uses this service.
IRC(TCP/UDP:6667)	This is another popular Internet chat program.
MSN Messenger (TCP:1863)	Microsoft Networks' messenger service uses this protocol.
MULTICAST(IGMP:0)	Internet Group Multicast Protocol is used when sending packets to a specific group of hosts.
NetBIOS(TCP/UDP:137~139, 45)	NetBIOS (Network Basic Input/Output System) are TCP or UDP broadcast packets that enable a computer to connect to and communicate with a LAN.
NEWS(TCP:144)	A protocol for news groups.
NFS(UDP:2049)	Network File System – NFS is a client/server distributed file service that provides transparent file sharing for network environments.
NNTP(TCP:119)	Network News Transport Protocol is the delivery mechanism for the USENET newsgroup service.
PING(ICMP:0)	Packet Internet Groper is a protocol that sends out ICMP echo requests to test whether or not a remote host is reachable.
POP3(TCP:110)	Post Office Protocol version 3 lets a client computer get e-mail from a POP3 server through a temporary connection (TCP/IP or other).
PPTP(TCP:1723)	Point-to-Point Tunneling Protocol enables secure transfer of data over public networks. This is the control channel.
PPTP_TUNNEL(GRE:0)	Point-to-Point Tunneling Protocol enables secure transfer of data over public networks. This is the data channel.
RCMD(TCP:512)	Remote Command Service.
REAL_AUDIO(TCP:7070)	A streaming audio service that enables real time sound over the web.
REXEC(TCP:514)	Remote Execution Daemon.
RLOGIN(TCP:513)	Remote Login.
ROADRUNNER(TCP/UDP:1026)	This is Time Warner's cable modem session management protocol. It handles authentication and dynamic addressing.

Table 59 Predefined Services (continued)

SERVICE	DESCRIPTION
RTELNET(TCP:107)	Remote Telnet.
RTSP(TCP/UDP:554)	The Real Time Streaming (media control) Protocol (RTSP) is a remote control for multimedia on the Internet.
SFTP(TCP:115)	Simple File Transfer Protocol.
SIP-V2(UDP:5060)	The Session Initiation Protocol (SIP) is an application-layer control (signaling) protocol that handles the setting up, altering and tearing down of voice and multimedia sessions over the Internet. SIP is used in VoIP (Voice over IP), the sending of voice signals over the Internet Protocol.
SMTP(TCP:25)	Simple Mail Transfer Protocol is the message-exchange standard for the Internet. SMTP enables you to move messages from one e-mail server to another.
SNMP(TCP/UDP:161)	Simple Network Management Program.
SNMP-TRAPS(TCP/UDP:162)	Traps for use with the SNMP (RFC:1215).
SQL-NET(TCP:1521)	Structured Query Language is an interface to access data on many different types of database systems, including mainframes, midrange systems, UNIX systems and network servers.
SSDP(UDP:1900)	Simple Service Discovery Protocol (SSDP) is a discovery service searching for Universal Plug and Play devices on your home network or upstream Internet gateways using UDP port 1900.
SSH(TCP/UDP:22)	Secure Shell Remote Login Program.
STRMWORKS(UDP:1558)	Stream Works Protocol.
SYSLOG(UDP:514)	Syslog allows you to send system logs to a UNIX server.
TACACS(UDP:49)	Login Host Protocol used for (Terminal Access Controller Access Control System).
TELNET(TCP:23)	Telnet is the login and terminal emulation protocol common on the Internet and in UNIX environments. It operates over TCP/IP networks. Its primary function is to allow users to log into remote host systems.
TFTP(UDP:69)	Trivial File Transfer Protocol is an Internet file transfer protocol similar to FTP, but uses the UDP (User Datagram Protocol) rather than TCP (Transmission Control Protocol).
VDOLIVE(TCP:7000)	Another videoconferencing solution.

10.9 Anti-Probing

If an outside user attempts to probe an unsupported port on your ZyWALL, an ICMP response packet is automatically returned. This allows the outside user to know the ZyWALL exists. The ZyWALL supports anti-probing, which prevents the ICMP response packet from being sent. This keeps outsiders from discovering your ZyWALL when unsupported ports are probed.

Internet Control Message Protocol (ICMP) is a message control and error-reporting protocol between a host server and a gateway to the Internet. ICMP uses Internet Protocol (IP) datagrams, but the messages are processed by the TCP/IP software and directly apparent to the application user.

Click **FIREWALL**, then the **Anti-Probing** tab to open the screen.

Figure 78 Anti-Probing



The following table describes the labels in this screen.

Table 60 Anti-Probing

LABEL	DESCRIPTION
Respond to PING on	The ZyWALL does not respond to any incoming Ping requests when Disable is selected. Select LAN to reply to incoming LAN Ping requests. Select WAN to reply to incoming WAN Ping requests. Select DMZ to reply to incoming DMZ Ping requests. Otherwise select LAN & WAN & DMZ to reply to both incoming LAN and WAN and DMZ Ping requests.
Do not respond to requests for unauthorized services.	Select this option to prevent hackers from finding the ZyWALL by probing for unused ports. If you select this option, the ZyWALL will not respond to port request(s) for unused ports, thus leaving the unused ports and the ZyWALL unseen. By default this option is not selected and the ZyWALL will reply with an ICMP Port Unreachable packet for a port probe on its unused UDP ports, and a TCP Reset packet for a port probe on its unused TCP ports. Note that the probing packets must first traverse the ZyWALL 's firewall mechanism before reaching this anti-probing mechanism. Therefore if the firewall mechanism blocks a probing packet, the ZyWALL reacts based on the firewall policy, which by default, is to send a TCP reset packet for a blocked TCP packet. You can use the command "sys firewall tcrst rst [on off]" to change this policy. When the firewall mechanism blocks a UDP packet, it drops the packet without sending a response packet.
Apply	Click Apply to save your changes back to the ZyWALL.
Reset	Click Reset to begin configuring this screen afresh.

10.10 DoS Thresholds

In the **Threshold** screen, shown later, you may choose to generate an alert whenever an attack is detected. For DoS attacks, the ZyWALL uses thresholds to determine when to drop sessions that do not become fully established. These thresholds apply globally to all sessions.

You can use the default threshold values, or you can change them to values more suitable to your security requirements.

10.10.1 Threshold Values

Tune these parameters when something is not working and after you have checked the firewall counters. These default values should work fine for normal small offices with ADSL bandwidth. Factors influencing choices for threshold values are:

- 1 The maximum number of opened sessions.
- 2 The minimum capacity of server backlog in your LAN network.
- 3 The CPU power of servers in your LAN network.
- 4 Network bandwidth.
- 5 Type of traffic for certain servers.

If your network is slower than average for any of these factors (especially if you have servers that are slow or handle many tasks and are often busy), then the default values should be reduced.

You should make any changes to the threshold values before you continue configuring firewall rules.

10.10.2 Half-Open Sessions

For TCP, half-open means that the session has not reached the established state-the TCP three-way handshake has not yet been completed (see [Figure 62 on page 170](#)). For UDP, half-open means that the firewall has detected no return traffic. An unusually high number of half-open sessions (either an absolute number or measured as the arrival rate) could indicate that a Denial of Service attack is occurring.

The ZyWALL measures both the total number of existing half-open sessions and the rate of session establishment attempts. Both TCP and UDP half-open sessions are counted in the total number and rate measurements. Measurements are made once a minute.

When the number of existing half-open sessions rises above a threshold (**max-incomplete high**), the ZyWALL starts deleting half-open sessions as required to accommodate new connection requests. The ZyWALL continues to delete half-open requests as necessary, until the number of existing half-open sessions drops below another threshold (**max-incomplete low**).

When the rate of new connection attempts rises above a threshold (**one-minute high**), the ZyWALL starts deleting half-open sessions as required to accommodate new connection requests. The ZyWALL continues to delete half-open sessions as necessary, until the rate of new connection attempts drops below another threshold (**one-minute low**). The rate is the number of new attempts detected in the last one-minute sample period.

10.10.2.1 TCP Maximum Incomplete and Blocking Time

An unusually high number of half-open sessions with the same destination host address could indicate that a Denial of Service attack is being launched against the host.

Whenever the number of half-open sessions with the same destination host address rises above a threshold (**TCP Maximum Incomplete**), the ZyWALL starts deleting half-open sessions according to one of the following methods:

- 1 If the **Blocking Time** timeout is 0 (the default), then the ZyWALL deletes the oldest existing half-open session for the host for every new connection request to the host. This ensures that the number of half-open sessions to a given host will never exceed the threshold.
- 2 If the **Blocking Time** timeout is greater than 0, then the ZyWALL blocks all new connection requests to the host giving the server time to handle the present connections. The ZyWALL continues to block all new connection requests until the **Blocking Time** expires.

The ZyWALL also sends alerts whenever **TCP Maximum Incomplete** is exceeded. The global values specified for the threshold and timeout apply to all TCP connections. Click the **FIREWALL** link and then the **Threshold** tab to bring up the next screen.

Figure 79 Firewall Threshold

The following table describes the labels in this screen.

Table 61 Firewall Threshold

LABEL	DESCRIPTION
Denial of Service Thresholds	
One Minute Low	This is the rate of new half-open sessions that causes the firewall to stop deleting half-open sessions. The ZyWALL continues to delete half-open sessions as necessary, until the rate of new connection attempts drops below this number.

Table 61 Firewall Threshold (continued)

LABEL	DESCRIPTION
One Minute High	<p>This is the rate of new half-open sessions that causes the firewall to start deleting half-open sessions. When the rate of new connection attempts rises above this number, the ZyWALL deletes half-open sessions as required to accommodate new connection attempts.</p> <p>The numbers, say 80 in the One Minute Low field and 100 in this field, cause the ZyWALL to start deleting half-open sessions when more than 100 session establishment attempts have been detected in the last minute, and to stop deleting half-open sessions when fewer than 80 session establishment attempts have been detected in the last minute.</p>
Maximum Incomplete Low	<p>This is the number of existing half-open sessions that causes the firewall to stop deleting half-open sessions. The ZyWALL continues to delete half-open requests as necessary, until the number of existing half-open sessions drops below this number.</p>
Maximum Incomplete High	<p>This is the number of existing half-open sessions that causes the firewall to start deleting half-open sessions. When the number of existing half-open sessions rises above this number, the ZyWALL deletes half-open sessions as required to accommodate new connection requests. Do not set Maximum Incomplete High to lower than the current Maximum Incomplete Low number.</p> <p>The above values, say 80 in the Maximum Incomplete Low field and 100 in this field, cause the ZyWALL to start deleting half-open sessions when the number of existing half-open sessions rises above 100, and to stop deleting half-open sessions with the number of existing half-open sessions drops below 80.</p>
TCP Maximum Incomplete	<p>This is the number of existing half-open TCP sessions with the same destination host IP address that causes the firewall to start dropping half-open sessions to that same destination host IP address. Enter a number between 1 and 256. As a general rule, you should choose a smaller number for a smaller network, a slower system or limited bandwidth.</p>
Action taken when the TCP Maximum Incomplete threshold is reached.	
Delete the oldest half open session when new connection request comes	<p>Select this radio button to clear the oldest half open session when a new connection request comes.</p>
Deny new connection request for	<p>Select this radio button and specify for how long the ZyWALL should block new connection requests when TCP Maximum Incomplete is reached. Enter the length of blocking time in minutes (between 1 and 256).</p>
Apply	<p>Click Apply to save your changes back to the ZyWALL.</p>
Reset	<p>Click Reset to begin configuring this screen afresh.</p>

CHAPTER 11

Content Filtering Screens

This chapter provides an overview of content filtering.

11.1 Content Filtering Overview

Content filtering allows you to block certain web features, such as Cookies, and/or restrict specific websites. With content filtering, you can do the following:

11.1.1 Restrict Web Features

The ZyWALL can block web features such as ActiveX controls, Java applets, cookies and disable web proxies.

11.1.2 Create a Filter List

You can select categories, such as pornography or racial intolerance, to block from a pre-defined list.

11.1.3 Customize Web Site Access

You can specify URLs to which the ZyWALL blocks access. You can alternatively block access to all URLs except ones that you specify. You can also have the ZyWALL block access to URLs that contain key words that you specify.

11.2 General Content Filter Configuration

Click **CONTENT FILTER** and the screen will display as shown. Use this screen to enable content filtering, configure a schedule, and create a denial message. You can also choose specific computers to be included in or excluded from the content filtering configuration.

Figure 80 Content Filter : General

The following table describes the labels in this screen.

Table 62 Content Filter : General

LABEL	DESCRIPTION
General Setup	
Enable Content Filter	Select this check box to enable the content filter.
Restrict Web Features	Select the check box(es) to restrict a feature. When you download a page containing a restricted feature, that part of the web page will appear blank or grayed out.
Block ActiveX	ActiveX is a tool for building dynamic and active web pages and distributed object applications. When you visit an ActiveX web site, ActiveX controls are downloaded to your browser, where they remain in case you visit the site again.
Java	Java is a programming language and development environment for building downloadable Web components or Internet and intranet business applications of all kinds.

Table 62 Content Filter : General

LABEL	DESCRIPTION
Cookies	Cookies are files stored on a computer's hard drive. Some web servers use them to track usage and provide service based on ID.
Web Proxy	A server that acts as an intermediary between a user and the Internet to provide security, administrative control, and caching service. When a proxy server is located on the WAN it is possible for LAN users to circumvent content filtering by pointing to this proxy server.
Schedule to Block	Content filtering scheduling applies to the Filter List, Customized sites and Keywords. Restricted web server data, such as ActiveX, Java, Cookies and Web Proxy are not affected.
Always Block	Click this option button to have content filtering always active with Time of Day limitations not enforced. This is enabled by default.
Block From/To	Click this option button to have content filtering only active during the time interval specified. In the Block From and To fields, enter the time period, in 24-hour format, during which content filtering will be enforced.
Message to display when a site is blocked	
Denied Access Message	Enter a message to be displayed when a user tries to access a restricted web site. The default message is Please contact your network administrator!!
Exempt Computers	
Enforce content filter policies for all computers	Select this checkbox to have all users on your LAN follow content filter policies (default).
Include specified address ranges in the content filter enforcement	Select this checkbox to have a specific range of users on your LAN follow content filter policies.
Exclude specified address ranges from the content filter enforcement	Select this checkbox to exempt a specific range of users on your LAN from content filter policies.
Add Address Ranges	
From	Type the beginning IP address (in dotted decimal notation) of the specific range of users on your LAN.
To	Type the ending IP address (in dotted decimal notation) of the specific range of users on your LAN, then click Add Range .
Address List	This text field shows the address ranges that are blocked.
Add Range	Click Add Range after you have filled in the From and To fields above.
Delete Range	Click Delete Range after you select the range of addresses you wish to delete.
Apply	Click Apply to save your changes back to the ZyWALL.
Reset	Click Reset to begin configuring this screen afresh.

11.3 Content Filtering with an External Database

When you register for and enable external database content filtering, your ZyWALL accesses an external database that has millions of web sites categorized based on content. You can have the ZyWALL block, block and/or log access to web sites based on these categories. The content filtering lookup process is described below.

Figure 81 Content Filtering Lookup Procedure

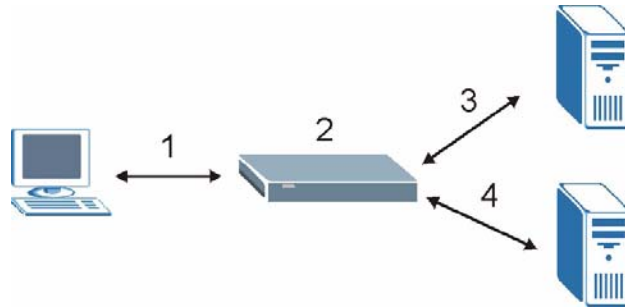

- 1 A computer behind the ZyWALL tries to access a web site.
- 2 The ZyWALL looks up the web site in its cache. If an attempt to access the web site was made in the past, a record of that web site's category will be in the ZyWALL's cache. The ZyWALL block, block and log or just log the request based on your configuration.
- 3 Use the **Content Filter Cache** screen to configure how long a web site address remains in the cache as well as view those web site addresses (see [Section 11.7 on page 215](#)). All of the web site address records are also cleared from the local cache when the ZyWALL restarts.
- 4 If the ZyWALL has no record of the web site, it will query the external content filtering database and simultaneously send the request to the web server.

The external content filtering database may change a web site's category or categorize a previously uncategorized web site.
- 5 The external content filtering server sends the category information back to the ZyWALL, which then blocks and/or logs access to the web site. The web site's address and category are then stored in the ZyWALL's content filtering cache.

11.4 Categories and Registering

To register for and configure category-based content filtering, click **CONTENT FILTER**, and then the **Categories** tab to display the screen shown next. Use this screen to enable external database content filtering and select which web site categories to block and/or log. You must register for external content filtering before you can use it (see [Chapter 12 on page 217](#) for detailed information).

Figure 82 Content Filter : Categories

CONTENT FILTER

General Categories Customization Cache

Auto Category Setup

Enable External Database Content Filtering

Block Log **Matched Web Pages**

Block Log **Unrated Web Pages**

Block Log **When Content Filter Server Is Unavailable**

Content Filter Server Unavailable Timeout (1-30 seconds)

Select Categories

Select All Categories Clear All Categories

Adult/Mature Content Pornography Sex Education

Intimate Apparel/Swimsuit Nudity Alcohol/Tobacco

Illegal/Questionable Gambling Violence/Hate/Racism

Weapons Abortion Arts/Entertainment

Business/Economy Cult/Occult Illegal Drugs

Test Web Site Attribute:

Test if Web site is blocked (Domain Name or IP Address)

Registration and Reports

Click **Register** to register for external content filtering. You can use a trial application or register your iCard's PIN. You can also view and update your registration status or view content filtering reports.

Registration Status: **Unregistered**

The following table describes the labels in this screen.

Table 63 Content Filter: Categories

LABEL	DESCRIPTION
Auto Category Setup	
Enable External Database Content Filtering	Enable external database content filtering to have the ZyWALL check an external database to find to which category a requested web page belongs. The ZyWALL then blocks or forwards access to the web page depending on the configuration of the rest of this page.
Matched Web Pages	Select Block to prevent users from accessing web pages that match the categories that you select below. When external database content filtering blocks access to a web page, it displays the denied access message that you configured in the CONTENT FILTER General screen along with the category of the blocked web page. Select Log to record attempts to access prohibited web pages.

Table 63 Content Filter: Categories (continued)

LABEL	DESCRIPTION
Unrated Web Pages	<p>Select Block to prevent users from accessing web pages that the external database content filtering has not categorized.</p> <p>When the external database content filtering blocks access to a web page, it displays the denied access message that you configured in the CONTENT FILTER General screen along with the category of the blocked web page.</p> <p>Select Log to record attempts to access web pages that are not categorized.</p>
When Content Filter Server Is Unavailable	<p>Select Block to block access to any requested web page if the external content filtering database is unavailable. The following are possible causes:</p> <ul style="list-style-type: none"> There is no response from the external content filtering server within the time period specified in the Content Filter Server Unavailable Timeout field. The ZyWALL is not able to resolve the domain name of the external content filtering database. There is an error response from the external content filtering database. This can be caused by an expired content filtering registration (External content filtering's license key is invalid"). <p>Select Log to record attempts to access web pages that occur when the external content filtering database is unavailable.</p>
Content Filter Server Unavailable Timeout	<p>Specify a number of seconds (1 to 30) for the ZyWALL to wait for a response from the external content filtering server. If there is still no response by the time this period expires, the ZyWALL blocks or allows access to the requested web page based on the setting in the Block When Content Filter Server Is Unavailable field.</p>
Select Categories	
Select All Categories	<p>Select this check box to restrict access to all site categories listed below.</p>
Clear All Categories	<p>Select this check box to clear the selected categories below.</p>
Adult/Mature Content	<p>Selecting this category excludes pages that contain material of adult nature that does not necessarily contain excessive violence, sexual content, or nudity. These pages include very profane or vulgar content and pages that are not appropriate for children.</p>
Pornography	<p>Selecting this category excludes pages that contain sexually explicit material for the purpose of arousing a sexual or prurient interest.</p>
Sex Education	<p>Selecting this category excludes pages that provide graphic information (sometimes graphic) on reproduction, sexual development, safe sex practices, sexuality, birth control, and sexual development. It also includes pages that offer tips for better sex as well as products used for sexual enhancement.</p>
Intimate Apparel/Swimsuit	<p>Selecting this category excludes pages that contain images or offer the sale of swimsuits or intimate apparel or other types of suggestive clothing. It does not include pages selling undergarments as a subsection of other products offered.</p>
Nudity	<p>Selecting this category excludes pages containing nude or seminude depictions of the human body. These depictions are not necessarily sexual in intent or effect, but may include pages containing nude paintings or photo galleries of artistic nature. This category also includes nudist or naturist pages that contain pictures of nude individuals.</p>

Table 63 Content Filter: Categories (continued)

LABEL	DESCRIPTION
Alcohol/Tobacco	Selecting this category excludes pages that promote or offer the sale alcohol/tobacco products, or provide the means to create them. It also includes pages that glorify, tout, or otherwise encourage the consumption of alcohol/tobacco. It does not include pages that sell alcohol or tobacco as a subset of other products.
Illegal/Questionable	Selecting this category excludes pages that advocate or give advice on performing illegal acts such as service theft, evading law enforcement, fraud, burglary techniques and plagiarism. It also includes pages that provide or sell questionable educational materials, such as term papers. Note: This category includes sites identified as being malicious in any way (such as having viruses, spyware and etc.).
Gambling	Selecting this category excludes pages where a user can place a bet or participate in a betting pool (including lotteries) online. It also includes pages that provide information, assistance, recommendations, or training on placing bets or participating in games of chance. It does not include pages that sell gambling related products or machines. It also does not include pages for offline casinos and hotels (as long as those pages do not meet one of the above requirements).
Violence/Hate/Racism	Selecting this category excludes pages that depict extreme physical harm to people or property, or that advocate or provide instructions on how to cause such harm. It also includes pages that advocate, depict hostility or aggression toward, or denigrate an individual or group on the basis of race, religion, gender, nationality, ethnic origin, or other characteristics.
Weapons	Selecting this category excludes pages that sell, review, or describe weapons such as guns, knives or martial arts devices, or provide information on their use, accessories, or other modifications. It does not include pages that promote collecting weapons, or groups that either support or oppose weapons use.
Abortion	Selecting this category excludes pages that provide information or arguments in favor of or against abortion, describe abortion procedures, offer help in obtaining or avoiding abortion, or provide information on the effects, or lack thereof, of abortion.
Arts/Entertainment	Selecting this category excludes pages that promote and provide information about motion pictures, videos, television, music and programming guides, books, comics, movie theatres, galleries, artists or reviews on entertainment.
Business/Economy	Selecting this category excludes pages devoted to business firms, business information, economics, marketing, business management and entrepreneurship. This does not include pages that perform services that are defined in another category (such as Information Technology companies, or companies that sell travel services).
Cult/Occult	Selecting this category excludes pages that promote or offer methods, means of instruction, or other resources to affect or influence real events through the use of spells, curses, magic powers and satanic or supernatural beings.
Illegal Drugs	Selecting this category excludes pages that promote, offer, sell, supply, encourage or otherwise advocate the illegal use, cultivation, manufacture, or distribution of drugs, pharmaceuticals, intoxicating plants or chemicals and their related paraphernalia.

Table 63 Content Filter: Categories (continued)

LABEL	DESCRIPTION
Education	Selecting this category excludes pages that offer educational information, distance learning and trade school information or programs. It also includes pages that are sponsored by schools, educational facilities, faculty, or alumni groups.
Cultural Institutions	Selecting this category excludes pages sponsored by cultural institutions, or those that provide information about museums, galleries, and theaters (not movie theaters). It includes groups such as 4H and the Boy Scouts of America.
Financial Services	Selecting this category excludes pages that provide or advertise banking services (online or offline) or other types of financial information, such as loans. It does not include pages that offer market information, brokerage or trading services.
Brokerage/Trading	Selecting this category excludes pages that provide or advertise trading of securities and management of investment assets (online or offline). It also includes insurance pages, as well as pages that offer financial investment strategies, quotes, and news.
Games	Selecting this category excludes pages that provide information and support game playing or downloading, video games, computer games, electronic games, tips, and advice on games or how to obtain cheat codes. It also includes pages dedicated to selling board games as well as journals and magazines dedicated to game playing. It includes pages that support or host online sweepstakes and giveaways.
Government/Legal	Selecting this category excludes pages sponsored by or which provide information on government, government agencies and government services such as taxation and emergency services. It also includes pages that discuss or explain laws of various governmental entities.
Military	Selecting this category excludes pages that promote or provide information on military branches or armed services.
Political/Activist Groups	Selecting this category excludes pages sponsored by or which provide information on political parties, special interest groups, or any organization that promotes change or reform in public policy, public opinion, social practice, or economic activities.
Health	Selecting this category excludes pages that provide advice and information on general health such as fitness and well-being, personal health or medical services, drugs, alternative and complimentary therapies, medical information about ailments, dentistry, optometry, general psychiatry, self-help, and support organizations dedicated to a disease or condition.
Computers/Internet	Selecting this category excludes pages that sponsor or provide information on computers, technology, the Internet and technology-related organizations and companies.
Hacking/Proxy Avoidance	Pages providing information on illegal or questionable access to or the use of communications equipment/software, or provide information on how to bypass proxy server features or gain access to URLs in any way that bypasses the proxy server.
Search Engines/Portals	Selecting this category excludes pages that support searching the Internet, indices, and directories.
Web Communications	Selecting this category excludes pages that allow or offer Web-based communication via e-mail, chat, instant messaging, message boards, etc.
Job Search/Careers	Selecting this category excludes pages that provide assistance in finding employment, and tools for locating prospective employers.

Table 63 Content Filter: Categories (continued)

LABEL	DESCRIPTION
News/Media	Selecting this category excludes pages that primarily report information or comments on current events or contemporary issues of the day. It also includes radio stations and magazines. It does not include pages that can be rated in other categories.
Personals/Dating	Selecting this category excludes pages that promote interpersonal relationships.
Reference	Selecting this category excludes pages containing personal, professional, or educational reference, including online dictionaries, maps, census, almanacs, library catalogues, genealogy-related pages and scientific information.
Chat/Instant Messaging	Selecting this category excludes pages that provide chat or instant messaging capabilities or client downloads.
Email	Selecting this category excludes pages offering web-based email services, such as online email reading, e-cards, and mailing list services.
Newsgroups	Selecting this category excludes pages that offer access to Usenet news groups or other messaging or bulletin board systems.
Religion	Selecting this category excludes pages that promote and provide information on conventional or unconventional religious or quasi-religious subjects, as well as churches, synagogues, or other houses of worship. It does not include pages containing alternative religions such as Wicca or witchcraft (Cult/Occult) or atheist beliefs (Political/Activist Groups).
Shopping	Selecting this category excludes pages that provide or advertise the means to obtain goods or services. It does not include pages that can be classified in other categories (such as vehicles or weapons).
Auctions	Selecting this category excludes pages that support the offering and purchasing of goods between individuals. This does not include classified advertisements.
Real Estate	Selecting this category excludes pages that provide information on renting, buying, or selling real estate or properties.
Society/Lifestyle	Selecting this category excludes pages providing information on matters of daily life. This does not include pages relating to entertainment, sports, jobs, sex or pages promoting alternative lifestyles such as homosexuality. Personal homepages fall within this category if they cannot be classified in another category.
Gay/Lesbian	Selecting this category excludes pages that provide information, promote, or cater to gay and lesbian lifestyles. This does not include pages that are sexually oriented.
Restaurants/Dining/Food	Selecting this category excludes pages that list, review, discuss, advertise and promote food, catering, dining services, cooking and recipes.
Sports/Recreation/Hobbies	Selecting this category excludes pages that promote or provide information about spectator sports, recreational activities, or hobbies. This includes pages that discuss or promote camping, gardening, and collecting.
Travel	Selecting this category excludes pages that promote or provide opportunity for travel planning, including finding and making travel reservations, vehicle rentals, descriptions of travel destinations, or promotions for hotels or casinos.
Vehicles	Selecting this category excludes pages that provide information on or promote vehicles, boats, or aircraft, including pages that support online purchase of vehicles or parts.

Table 63 Content Filter: Categories (continued)

LABEL	DESCRIPTION
Humor/Jokes	Selecting this category excludes pages that primarily focus on comedy, jokes, fun, etc. This may include pages containing jokes of adult or mature nature. Pages containing humorous Adult/Mature content also have an Adult/Mature category rating.
Streaming Media/MP3	Selecting this category excludes pages that sell, deliver, or stream music or video content in any format, including pages that provide downloads for such viewers.
Software Downloads	Selecting this category excludes pages that are dedicated to the electronic download of software packages, whether for payment or at no charge.
Pay to Surf	Selecting this category excludes pages that pay users in the form of cash or prizes, for clicking on or reading specific links, email, or web pages.
For Kids	Selecting this category excludes pages designed specifically for children.
Web Advertisements	Selecting this category excludes pages that provide online advertisements or banners. This does not include advertising servers that serve adult-oriented advertisements.
Web Hosting	Selecting this category excludes pages of organizations that provide top-level domain pages, as well as web communities or hosting services.
Advanced/Basic	Click Advanced to see an expanded list of categories, or click Basic to see a smaller list.
Test Web Site Attribute	
Test if Web site is blocked	You can check whether or not the content filter currently blocks any given web page. Enter a web site URL in the text box.
Test Against Local Cache	Click this button to test whether or not the web site above is saved in the ZyWALL's database of restricted web pages.
Test Against Internet Server	Click this button to test whether or not the web site above is saved in the external content filter server's database of restricted web pages.
Registration and Reports	
Registration Status	<p>This read-only field displays Registered if you have successfully registered the ZyWALL for category-based content filtering (using an external database).</p> <p>This field displays Unregistered if you have not successfully registered the ZyWALL or your registration has expired.</p> <p>Note: This field only displays whether or not you have successfully registered, not whether or not content filtering is active. See Section 12.7 on page 226 for how to check the content filtering activation.</p>

Table 63 Content Filter: Categories (continued)

LABEL	DESCRIPTION
Register	<p>Click Register to go to a web site where you can register for category-based content filtering (using an external database). You can use a trial application or register your iCard's PIN. Refer to the web site's on-line help for details.</p> <p>Note: The web site displays a registration successful web page. It may take up to another ten minutes for content filtering to be activated. See Section 12.7 on page 226 for how to check the content filtering activation.</p> <p>You can manage your registration status or view content filtering reports after you register this device.</p> <p>Note: You cannot access the web site if you have enabled content filtering in the Content Filtering General screen and blocked access to web pages that use Java.</p>
Apply	Click Apply to save your changes back to the ZyWALL.
Reset	Click Reset to begin configuring this screen afresh.

11.5 Customization

You can create a list of good (allowed) web site addresses and a list of bad (blocked) web site addresses on the ZyWALL. You can also block web sites based on whether the web site's address contains a keyword. To add or remove specific sites or keywords from the filter list on your ZyWALL, click **CONTENT FILTER**, then the **Customization** tab. The screen appears as shown.

Figure 83 Content Filter: Customization

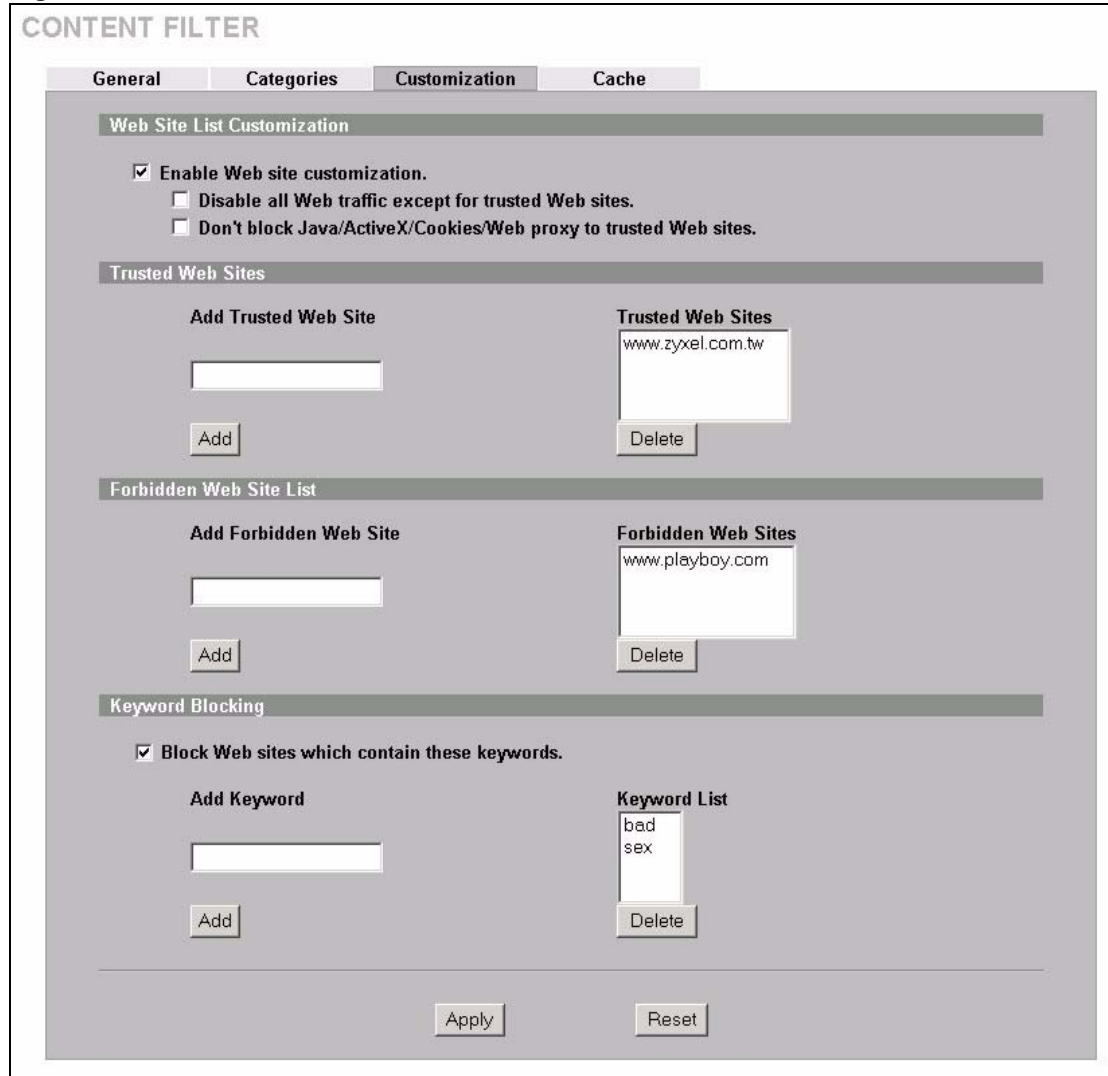

The following table describes the labels in this screen.

Table 64 Content Filter: Customization

LABEL	DESCRIPTION
Web Site List Customization	
Enable Web site customization	Select this check box to allow trusted web sites and block forbidden web sites. Content filter list customization may be enabled and disabled without re-entering these site names.
Disable all Web traffic except for trusted Web sites	When this box is selected, the ZyWALL only allows Web access to sites on the Trusted Web Site list. If they are chosen carefully, this is the most effective way to block objectionable material.
Don't block Java/ActiveX/ Cookies/Web proxy to trusted Web sites	When this box is selected, the ZyWALL will permit Java, ActiveX and Cookies from sites on the Trusted Web Site list to the LAN. In certain cases, it may be desirable to allow Java, ActiveX or Cookies from sites that are known and trusted.

Table 64 Content Filter: Customization (continued)

LABEL	DESCRIPTION
Trusted Web Sites	These are sites that you want to allow access to, regardless of their content rating, can be allowed by adding them to this list. You can enter up to 32 entries.
Add Trusted Web Site	Enter host names such as www.good-site.com into this text field. Do not enter the complete URL of the site – that is, do not include “http://”. All subdomains are allowed. For example, entering “zyxel.com” also allows “www.zyxel.com”, “partner.zyxel.com”, “press.zyxel.com”, etc.
Trusted Web Sites	This list displays the trusted web sites already added.
Add	Click this button when you have finished adding the host name in the text field above.
Delete	Select a web site name from the Trusted Web Site List , and then click this button to delete it from that list.
Forbidden Web Site List	Sites that you want to block access to, regardless of their content rating, can be allowed by adding them to this list. You can enter up to 32 entries.
Add Forbidden Web Site	Enter host names such as www.bad-site.com into this text field. Do not enter the complete URL of the site – that is, do not include “http://”. All subdomains are allowed. For example, entering “bad-site.com” also blocks “www.bad-site.com”, “partner.bad-site.com”, “press.bad-site.com”, etc.
Forbidden Web Sites	This list displays the forbidden web sites already added.
Add	Click this button when you have finished adding the host name in the text field above.
Delete	Select a web site name from the Forbidden Web Site List , and then click this button to delete it from that list.
Keyword Blocking	<p>Keyword Blocking allows you to block websites with URLs that contain certain keywords in the domain name or IP address.</p> <p>Note: See Section 11.6 on page 214 for how to set how much of the URL the ZyWALL checks.</p>
Block Web sites which contain these keywords.	Select this checkbox to enable keyword blocking.
Add Keyword	Enter a keyword (up to 31 printable ASCII characters) to block. You can also enter a numerical IP address.
Keyword List	This list displays the keywords already added.
Add	Click this button when you have finished adding the key words field above.
Delete	Select a keyword from the Keyword List , and then click this button to delete it from that list.
Apply	Click Apply to save your changes back to the ZyWALL.
Reset	Click Reset to begin configuring this screen afresh.

11.6 Customizing Keyword Blocking URL Checking

You can use commands to set how much of a website's URL the content filter is to check for keyword blocking. See the appendices for information on how to access and use the command interpreter.

11.6.1 Domain Name or IP Address URL Checking

By default, the ZyWALL checks the URL's domain name or IP address when performing keyword blocking.

This means that the ZyWALL checks the characters that come before the first slash in the URL.

For example, with the URL www.zyxel.com.tw/news/pressroom.php, content filtering only searches for keywords within www.zyxel.com.tw.

11.6.2 Full Path URL Checking

Full path URL checking has the ZyWALL check the characters that come before the last slash in the URL.

For example, with the URL www.zyxel.com.tw/news/pressroom.php, full path URL checking searches for keywords within www.zyxel.com.tw/news/.

Use the `ip urlfilter customize actionFlags 6 [disable | enable]` command to extend (or not extend) the keyword blocking search to include the URL's full path.

11.6.3 File Name URL Checking

Filename URL checking has the ZyWALL check all of the characters in the URL.

For example, filename URL checking searches for keywords within the URL www.zyxel.com.tw/news/pressroom.php.

Use the `ip urlfilter customize actionFlags 8 [disable | enable]` command to extend (or not extend) the keyword blocking search to include the URL's complete filename.

11.7 Content Filtering Cache

To view and configure your ZyWALL's URL caching, click **CONTENT FILTER**, then the **Cache** tab. The screen appears as shown. You can use this screen to configure how long a categorized web site address remains in the cache as well as view those web site addresses to which access has been allowed or blocked based on the responses from the external content filtering server. The ZyWALL only queries the external content filtering database for sites not found in the cache.

You can also remove individual entries from the cache. When you do this, the ZyWALL queries the external content filtering database the next time someone tries to access that web site. This allows you to check whether a web site's category has been changed.

Figure 84 Content Filter: Cache

#	Action	URL	Remaining Time (hour)	Modify
1	Blocked	www.brucejones.com/	59	
2	Allowed	www.download.windowsupdate.com/msdownload/update/v...	60	
3	Allowed	www.download.windowsupdate.com/msdownload/update/v...	60	
4	Allowed	www.roundballcity.com/xoops/modules/news/article.p...	60	
5	Allowed	akapp.whenu.com/OfferDataGZ?update=20050111035631	60	
6	Allowed	ofs.zyxel.com.tw/officescan/cgi/cgiOnStart.exe	60	

The following table describes the labels in this screen.

Table 65 Content Filter: Cache

LABEL	DESCRIPTION
URL Cache Setup	
Maximum TTL	Type the maximum time to live (TTL) (1 to 720 hours). This sets how long the ZyWALL is to allow an entry to remain in the URL cache before discarding it.
Apply	Click Apply to save your changes back to the ZyWALL.
Reset	Click Reset to begin configuring this screen afresh.
URL Cache Entry	
Flush	Click this button to clear all web site addresses from the cache manually.

Table 65 Content Filter: Cache (continued)

LABEL	DESCRIPTION
Refresh	Click this button to reload the cache.
#	This is the index number of a categorized web site address record.
Action	This field shows whether access to the web site's URL was blocked-or allowed. Click the column heading to sort the entries. Point the triangle up to display the blocked URLs before the URLs to which access was allowed. Point the triangle down to display the URLs to which access was allowed before the blocked URLs.
URL	This is a web site's address that the ZyWALL previously checked with the external content filtering database.
Port	This is the service port number for which access was requested.
Remaining Time (hour)	This is the number of hours left before the URL entry is discarded from the cache.
Modify	Click the delete icon to remove the URL entry from the cache.

CHAPTER 12

Content Filtering Registration and Reports

This chapter describes how to register for content filtering and view content filtering reports.

Before you activate content filtering, you must create an account at myZyXEL.com and register your device.

Note: To activate content filtering, you need to access myZyXEL.com via the device on which you wish to register for content filtering.

You can only use the content filtering with the device upon which you register it. You cannot change devices. Your device's MAC address and serial number (see the sticker on the rear side of your device) identify it. You need to register separately for each device on which you wish to enable content filtering.

When registering, you need to enter a PIN (see your iCard). Be sure to buy the correct iCard for your device. If you wish to try content filtering before buying an iCard, then fill in the trial application for a free 30-day trial.

Content filtering reports are generated statistics and charts of access attempts to web sites belonging to the categories you selected in your device content filter screen.

You can also view content filtering reports during the free trial.

12.1 Introduction to myZyXEL.com

myZyXEL.com is ZyXEL's online services center where you can register your ZyXEL device. You can also generate an activation key and service set key that may be needed to use device-specific feature(s).

12.1.1 A Note on myZyXEL.com Numbers

You need the following (unique) numbers to register and activate device-specific feature(s).

Table 66 myZyXEL.com Numbers

TYPES	DESCRIPTION
Serial Number	You need the serial number to register your ZyXEL device. Locate the serial number on your ZyXEL device.
Authentication Code	This is the LAN MAC address of your ZyXEL device. You need this number to register your ZyXEL device at myZyXEL.com. Locate the MAC address on your ZyXEL device.

12.2 myZyXEL.com Account Registration

- 1 Go to myZyXEL.com using your web browser.
- 2 Create a new account (if you don't have one already) with a user name and password by clicking the hyperlink as shown in the next screen.

Figure 85 myZyXEL.com Login Screen

Login /
Welcome to myZyXEL.com

What's myZyXEL.com?
 myZyXEL.com provides an easy-to-use service management platform where you can manage all your ZyXEL product registrations and services using your personal account.
 Please register your account at myZyXEL.com first.
 Username:
 Password:
 Remember Username:

[+ Check if existing user](#)
 > Forgot User Name / Password? [Click here](#)
 > If you are not a registered user, [Click here](#)
Note:
 Currently, this registration website <http://www.myzyxel.com> supports Vantage CNM 2.0 and ZyWALL service activation. For other products support, we will announce soon in our next release.
Go Now!
 If you are a HS-100 or HS-100W user, before you register your account at myZyXEL.com, please go to: <http://www.us.zyxel.com/products/category.php?indexFlagvalue=1088555542> to download the latest product firmware to complete the service.

- 3 Fill in the required fields and click **Submit**.

Figure 86 myZyXEL.com Account Registration

Login / Registration

Registration

New to myZyXEL.com?

Registering allows you to download white papers and activate products and support subscriptions.
Complete this form to register for a myZyXEL.com user account

Fields marked by (*) are Required

Login Information

* Username Please enter your username from 6 to 20 characters. It may contain letters(a-z), numbers, or underscore character, other character are not allowed.

Check this Username is available

* Password Please enter your password from 6 to 20 characters. It is case sensitive. It may contain letters, numbers, other character are not allowed.

* Confirm Password

Password Hint If you forget your password, we will give you a hint (up to 40 characters)

Contact Information

* First Name:

4 A screen appears indicating you have created an account at myZyXEL.com.

Figure 87 Account Registration Successful

Login / Registration

Registration Successful

myZyXEL.com will send a confirmation e-mail to the e-mail address you configured in the registration form.

5 You will receive a confirmation e-mail. Click the URL in the e-mail to activate your account.

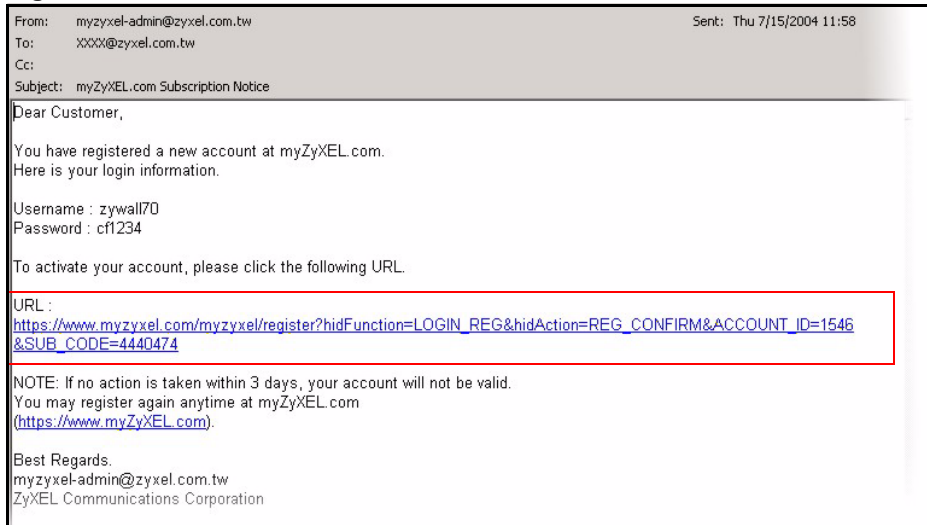
Figure 88 Account Confirmation E-Mail

6 Click **Continue** to go to the myZyXEL.com login screen.

Figure 89 myZyXEL.com Account Activation

12.3 Registering Your ZyXEL Device

1 After you have created a myZyXEL.com account, log in and register your ZyXEL device by clicking the hyperlink as shown in the next screen.

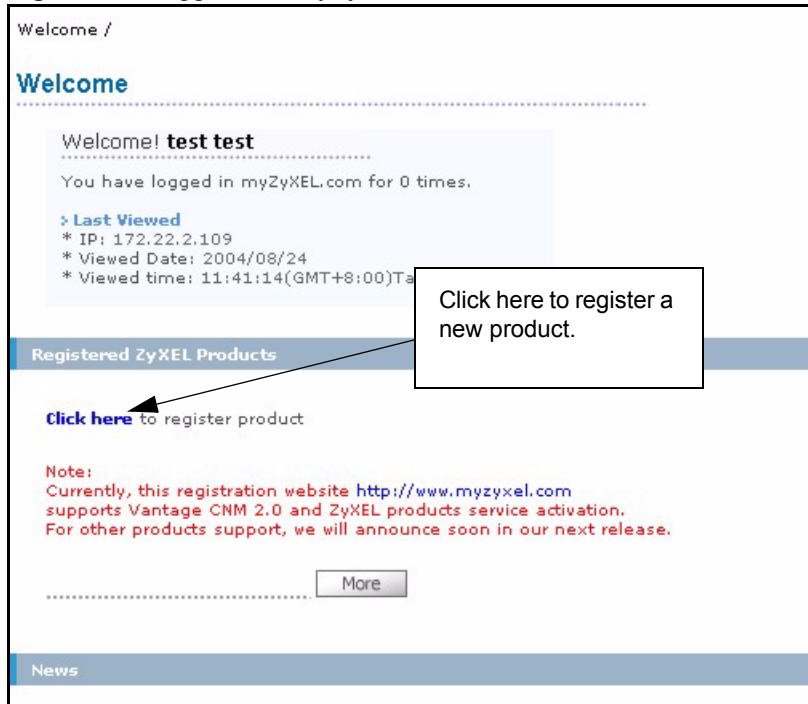
Figure 90 Logged Into myZyXEL.com

2 Click **Add** in the next screen.

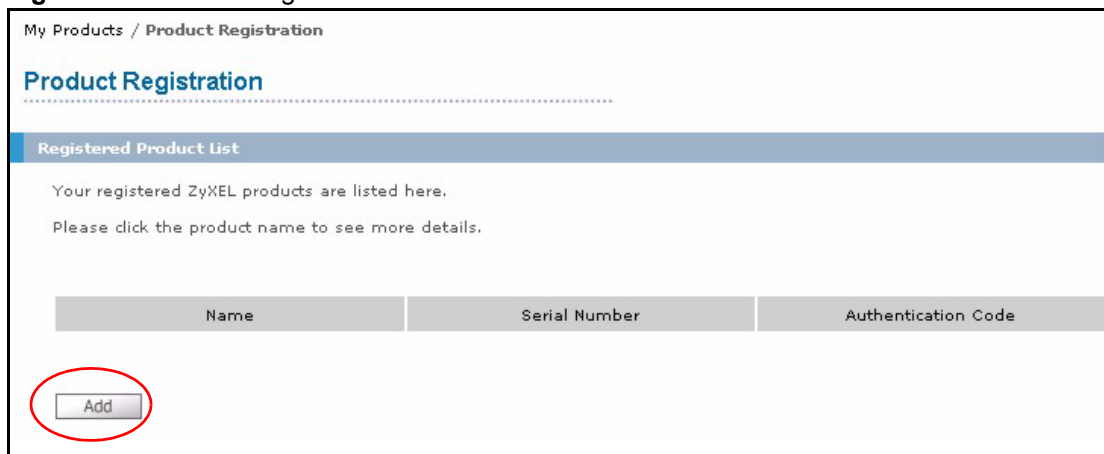
Figure 91 Product Registration

- 3** The **Add New Product** screen displays. Enter the product serial number in the **Serial Number** field.
- 4** Your device category and model number may automatically display in the **Category** and **Model** fields respectively. Otherwise, select the correct ones from the drop-down list boxes.
- 5** Enter the device MAC address in the **Authentication Code** field.
- 6** Enter a descriptive name in the **Friendly Name** field for identifying your device.
- 7** Click **Register**.

Figure 92 Add New Product

My Products / Product Registration

Add New Product

To add a new product, please fill in the following fields.
Friendly Name is an alias you give the product to identify it in the product list.

marked by (*) are Required

* Serial Number: Please enter the 10-digit number of the label on the unit. (Upper Case)

* Category:

* Model: **Your ZyXEL device MAC address may already be entered here.**

* Authentication Code / MAC Address : [Help](#)
For hardware products, this is the physical MAC address.
For software products, this is a generated number that is displayed after you install the software. (Upper Case)

* Friendly Name: Please give a name easy to remember for you. Up to 30 characters. It may contain letters (a-z), numbers, or underscore character, other character are not allowed.

8 Specify the purchase information and click **Continue**.

Figure 93 Product Survey

My Products / Product Registration

Product Survey

Product Information

+ Purchase date

+ You purchased this product from

9 Click **Continue** again.

10 After you have registered your ZyXEL device, you can view its registration details in the screen shown next.

Figure 94 Service Management

My Products / Service Activation

Service Management

Product Information

zy70cf

Serial Number: S4Z2928704
Products: ZyWALL 70
Authentication Code: 00A0C5012345

Manage Product

Manage this product's registration by clicking on the appropriate buttons below:

> zy70cf

Applicable Service List

To enable your service(s), please click "Activate" shown below to enter your license key(s).

	Service Name	Service Activation	Status	Expiry Date	Remark
1	Content Filter	Activate	-	-	-

12.4 Content Filtering Registration

- 1 In your ZyXEL device's web configurator, click **CONTENT FILTER**, **Categories** and then the **Register** button. The following screen opens.
- 2 Enter the user name and password from your myZyXEL.com account (see [Figure 85 on page 218](#)).
- 3 After you register your ZyXEL device, click **My Product** in the navigation panel.
- 4 Click the product name link for your device to view its registration details in the **Service Management** screen.

Figure 95 myZyXEL.com: My Product

myZyXEL.com

Welcome | My Account | **My Product** | Download Center | [SITE MAP](#) | [CONTACT US](#) | [LOGOUT](#) | ?

MY PRODUCTS

> Product Registration

My Products / Product Registration

Product Registration

Registered Product List

Your registered ZyXEL products are listed here.
Please click the product name to see more details.

	Name	Serial Number	Authentication Code
>	zy70cf	S4Z2928704	00A0C5012345

- 5 Click **Activate** for the content filtering service to display the next screen.

Figure 96 myZyXEL.com: Service Management.

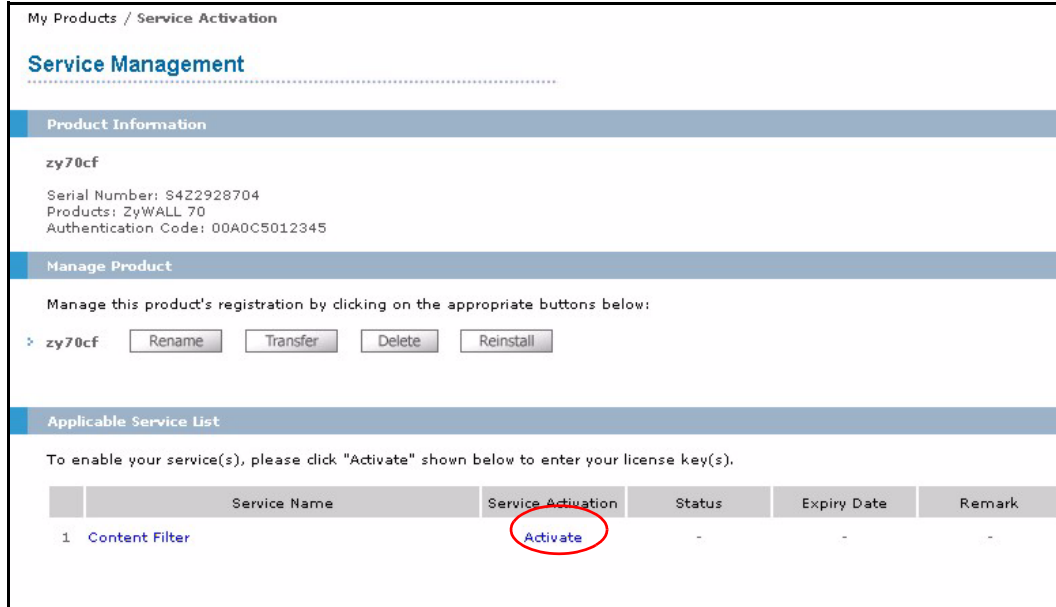

6 Enter the PIN code exactly as shown on your iCard (you do not enter a PIN if you are registering for the trial period) in the **License Key (PIN code)** field.

From the **Activation Date** drop-down list boxes, select the date when you want your content filtering to start and click **Submit** under **Registration Information**.

7 Otherwise, click **Submit** under **Content Filtering Trial** to register for a 30 day trial period. With the trial registration, content filtering functions for 30 days beginning from the date you apply for the trial.

After the trial, you cannot apply for another trial. If you've already registered an iCard's PIN number, then you also cannot apply for a trial.

If you have applied for a trial, you can still register the PIN code from an iCard by clicking **Upgrade** in the **Service Activation** field of the **Service Management** screen.

Figure 97 Service Registration

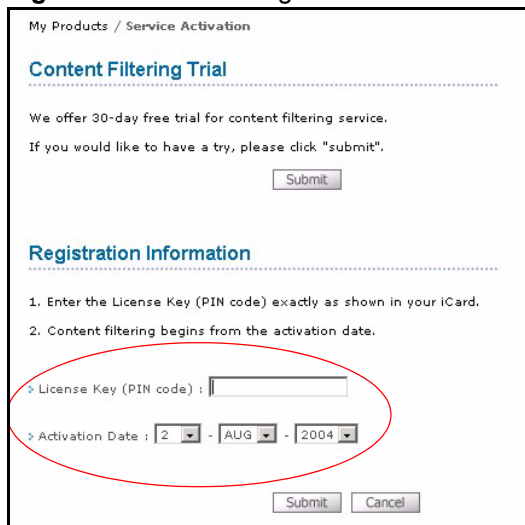

8 A screen displays showing you the service is registered. Click **Continue** to proceed to the **Service Management** screen.

Figure 98 Service Registration: Successful

My Products / Service Activation

Apply Standard Version Successful

Your E-mail Address : stanley_king@gfortunenet.com

Effective Period : 2004/07/31 ~ 2005/07/31

Your Name : stanley

Your Region : Taiwan

Figure 99 Service Management: Service Registered

My Products / Service Activation

Service Management

Product Information

zy70cf

Serial Number: S4Z2928704
Products: ZyWALL 70
Authentication Code: 00A0C5012345

Manage Product

Manage this product's registration by clicking on the appropriate buttons below:

zy70cf

Applicable Service List

To enable your service(s), please click "Activate" shown below to enter your license key(s).

	Service Name	Service Activation	Status	Expiry Date	Remark
1	Content Filter	<input type="button" value="Upgrade"/>	Installed	2004-09-02	Refresh

- 9 You can go on to update your product registration information, view content filtering reports or click **LOGOUT** at any time to exit myZyXEL.com.

12.5 Checking Content Filtering Activation

After you register for content filtering, the web site displays a registration successful web page. This does not mean the content filtering is active yet. You need to wait up to ten minutes for content filtering to be activated.

Since there will be no content filtering activation notice, you can do the following to see if content filtering is active.

- 1 Go to your device's web configurator's **CONTENT FILTER Categories** screen.
- 2 Select at least one category and click **Apply**.

- 3 Enter a valid URL or IP address of a web site in the **Test if Web site is blocked** field and click the **Test Against Internet Server** button.
When content filtering is active, you should see an access blocked or access forwarded message. An error message displays if content filtering is not active.

12.6 Updating Product Registration Information

- 1 Click **CONTENT FILTER**, **Categories** and then **Register**. The myZyXEL.com login screen opens (see [Figure 2 on page 223](#)).
- 2 After entering the user name and password from your myZyXEL.com account, click **My Product** (see [Figure 95 on page 223](#)) and the link for your ZyWALL to open the **Service Management** screen where you can modify your registration information (see [Figure 98 on page 225](#)).
- 3 From this screen, you may click **Rename** under **Manage Product** to modify your product's name, click **Transfer** under **Manage Product** to move the registered product to another pre-registered user account at myZyXEL.com, click **Delete** under **Manage Product** to remove the product registration or click **Reinstall** under **Manage Product** to install the product again with another authentication code (for up to three times). If you have activated a service on a registered product, you cannot delete that product. You cannot modify the PIN code, activation date or expiry date. Change the information that you need to modify and click **Submit**.

12.7 Viewing Content Filtering Reports

Content filtering reports are generated statistics and charts of access attempts to web sites belonging to the categories you selected in your device content filter screen.

You need to register your iCard before you can view content filtering reports.

Alternatively, you can also view content filtering reports during the free trial (up to 30 days).

- 1 In the **Service Management** screen (see [Figure 98 on page 225](#)) click **Content Filtering** in the **Service Name** field to open the following screen.

Figure 100 Cerberian Login Screen

- 2 Enter your ZyXEL device's MAC address (in lower case) in the **Name** field. Type the password that you configured during account registration at myZyXEL.com.
- 3 Click **Reports**.

Figure 101 Content Filtering Reports Main Screen

Note: The ZyWALL does not support Single User Reports at the time of writing.

- 4 Select either **Allow** or **Block** reports. Select a time period in the **Select Date Range** field and click **Run Report**.
- 5 A chart and list of requested web site categories display in the lower half of the screen.

Figure 102 Global Report Screen Example

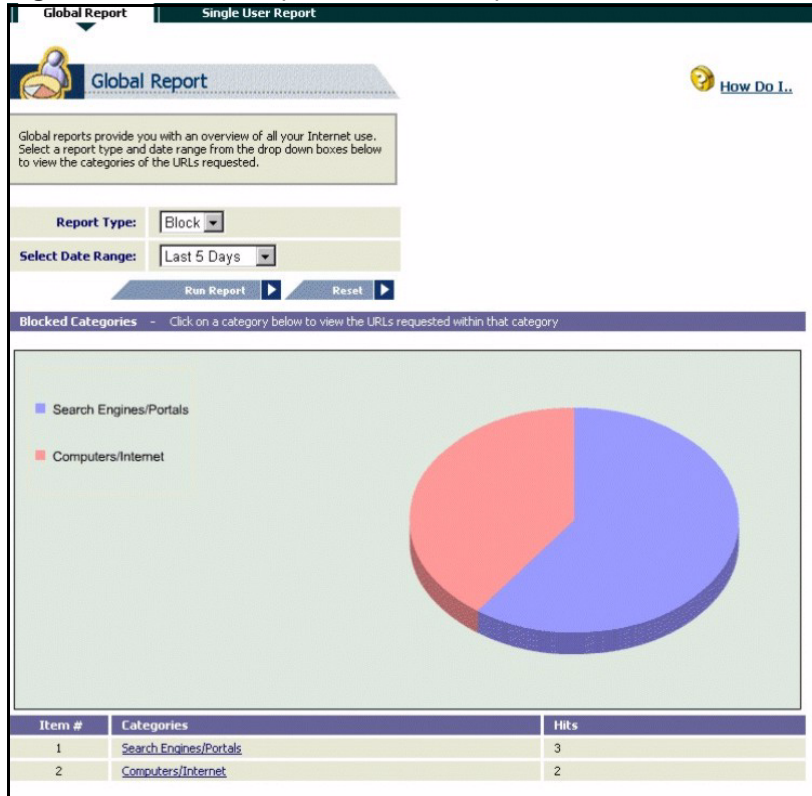

6 Click a category to see the URLs that were requested.

Figure 103 Requested URLs Example

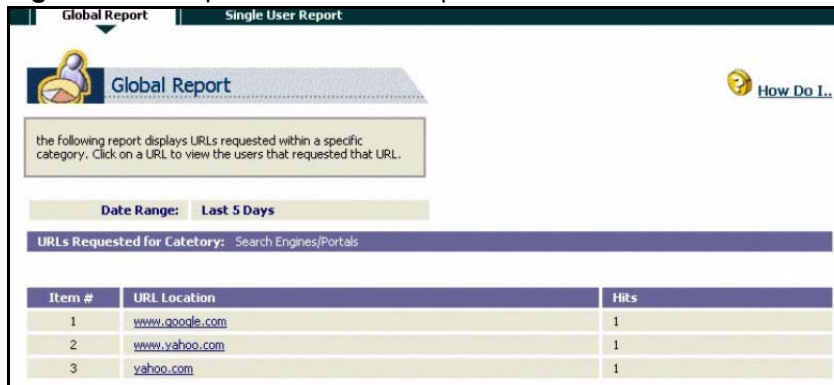

12.8 Configuration File

If you restore the ZyWALL to the default rom file or upload a different rom file after you register, then you must go to the **Service Management** screen (see [Figure 99 on page 225](#)) and click **Refresh** in the **Remark** field.

CHAPTER 13

Introduction to IPSec

This chapter introduces the basics of IPSec VPNs.

13.1 VPN Overview

A VPN (Virtual Private Network) provides secure communications between sites without the expense of leased site-to-site lines. A secure VPN is a combination of tunneling, encryption, authentication, access control and auditing technologies/services used to transport traffic over the Internet or any insecure network that uses the TCP/IP protocol suite for communication.

13.1.1 IPSec

Internet Protocol Security (IPSec) is a standards-based VPN that offers flexible solutions for secure data communications across a public network like the Internet. IPSec is built around a number of standardized cryptographic techniques to provide confidentiality, data integrity and authentication at the IP layer.

13.1.2 Security Association

A Security Association (SA) is a contract between two parties indicating what security parameters, such as keys and algorithms they will use.

13.1.3 Other Terminology

13.1.3.1 Encryption

Encryption is a mathematical operation that transforms data from "plaintext" (readable) to "ciphertext" (scrambled text) using a "key". The key and clear text are processed by the encryption operation, which leads to the data scrambling that makes encryption secure. Decryption is the opposite of encryption: it is a mathematical operation that transforms ciphertext to plaintext. Decryption also requires a key.

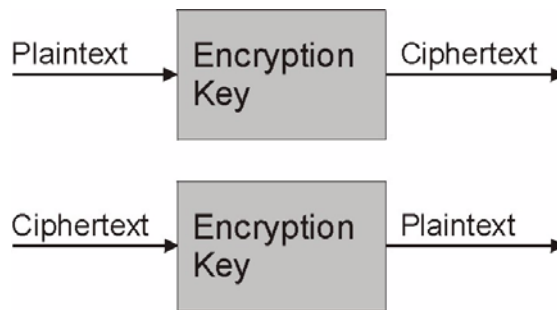
Figure 104 Encryption and Decryption

13.1.3.2 Data Confidentiality

The IPSec sender can encrypt packets before transmitting them across a network.

13.1.3.3 Data Integrity

The IPSec receiver can validate packets sent by the IPSec sender to ensure that the data has not been altered during transmission.

13.1.3.4 Data Origin Authentication

The IPSec receiver can verify the source of IPSec packets. This service depends on the data integrity service.

13.1.4 VPN Applications

The ZyWALL supports the following VPN applications.

13.1.4.1 Linking Two or More Private Networks Together

Connect branch offices and business partners over the Internet with significant cost savings and improved performance when compared to leased lines between sites.

13.1.4.2 Accessing Network Resources When NAT Is Enabled

When NAT is enabled, remote users are not able to access hosts on the LAN unless the host is designated a public LAN server for that specific protocol. Since the VPN tunnel terminates inside the LAN, remote users will be able to access all computers that use private IP addresses on the LAN.

13.1.4.3 Unsupported IP Applications

A VPN tunnel may be created to add support for unsupported emerging IP applications. See [Chapter 1 on page 49](#) for an example of a VPN application.

13.2 IPsec Architecture

The overall IPsec architecture is shown as follows.

Figure 105 IPsec Architecture

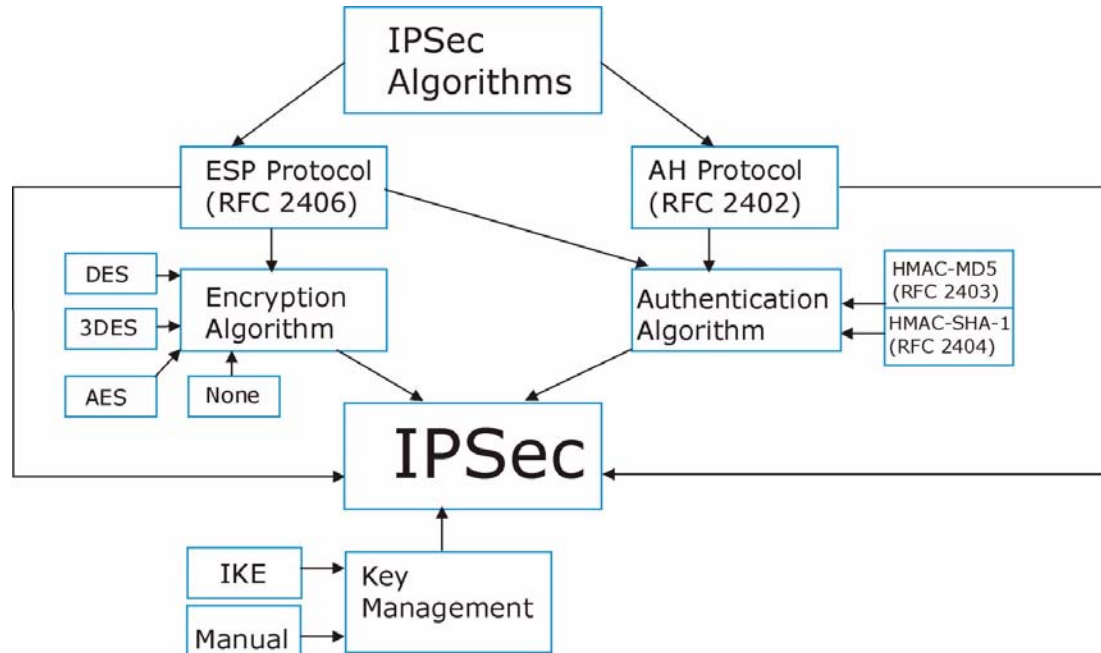

13.2.1 IPsec Algorithms

The **ESP** (Encapsulating Security Payload) Protocol (RFC 2406) and **AH** (Authentication Header) protocol (RFC 2402) describe the packet formats and the default standards for packet structure (including implementation algorithms).

The Encryption Algorithm describes the use of encryption techniques such as DES (Data Encryption Standard), AES (Advanced Encryption Standard) and Triple DES algorithms.

The Authentication Algorithms, HMAC-MD5 (RFC 2403) and HMAC-SHA-1 (RFC 2404), provide an authentication mechanism for the **AH** and **ESP** protocols. Refer to [Section 14.2 on page 235](#) for more information.

13.2.2 Key Management

Key management allows you to determine whether to use IKE (ISAKMP) or manual key configuration in order to set up a VPN.

13.3 Encapsulation

The two modes of operation for IPsec VPNs are **Transport** mode and **Tunnel** mode.

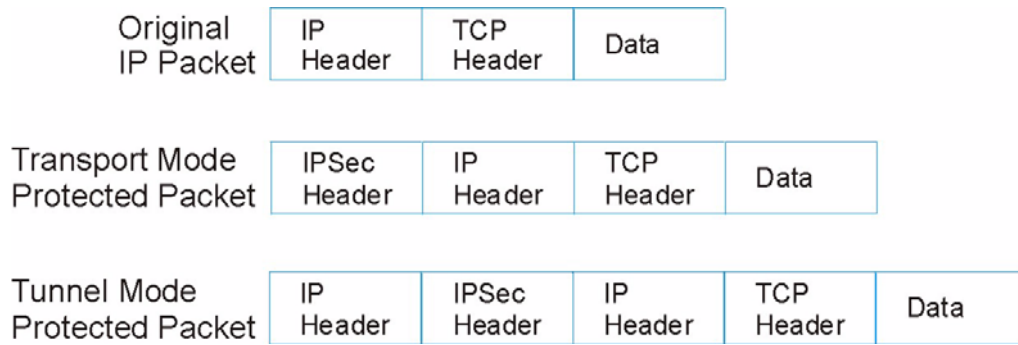
Figure 106 Transport and Tunnel Mode IPSec Encapsulation

13.3.1 Transport Mode

Transport mode is used to protect upper layer protocols and only affects the data in the IP packet. In **Transport** mode, the IP packet contains the security protocol (**AH** or **ESP**) located after the original IP header and options, but before any upper layer protocols contained in the packet (such as TCP and UDP).

With **ESP**, protection is applied only to the upper layer protocols contained in the packet. The IP header information and options are not used in the authentication process. Therefore, the originating IP address cannot be verified for integrity against the data.

With the use of **AH** as the security protocol, protection is extended forward into the IP header to verify the integrity of the entire packet by use of portions of the original IP header in the hashing process.

13.3.2 Tunnel Mode

Tunnel mode encapsulates the entire IP packet to transmit it securely. A **Tunnel** mode is required for gateway services to provide access to internal systems. **Tunnel** mode is fundamentally an IP tunnel with authentication and encryption. This is the most common mode of operation. **Tunnel** mode is required for gateway to gateway and host to gateway communications. **Tunnel** mode communications have two sets of IP headers:

- **Outside header:** The outside IP header contains the destination IP address of the VPN gateway.
- **Inside header:** The inside IP header contains the destination IP address of the final system behind the VPN gateway. The security protocol appears after the outer IP header and before the inside IP header.

13.4 IPSec and NAT

Read this section if you are running IPSec on a host computer behind the ZyWALL.

NAT is incompatible with the **AH** protocol in both **Transport** and **Tunnel** mode. An IPSec VPN using the **AH** protocol digitally signs the outbound packet, both data payload and headers, with a hash value appended to the packet. When using **AH** protocol, packet contents (the data payload) are not encrypted.

A NAT device in between the IPSec endpoints will rewrite either the source or destination address with one of its own choosing. The VPN device at the receiving end will verify the integrity of the incoming packet by computing its own hash value, and complain that the hash value appended to the received packet doesn't match. The VPN device at the receiving end doesn't know about the NAT in the middle, so it assumes that the data has been maliciously altered.

IPSec using **ESP** in **Tunnel** mode encapsulates the entire original packet (including headers) in a new IP packet. The new IP packet's source address is the outbound address of the sending VPN gateway, and its destination address is the inbound address of the VPN device at the receiving end. When using **ESP** protocol with authentication, the packet contents (in this case, the entire original packet) are encrypted. The encrypted contents, but not the new headers, are signed with a hash value appended to the packet.

Tunnel mode **ESP** with authentication is compatible with NAT because integrity checks are performed over the combination of the "original header plus original payload," which is unchanged by a NAT device. **Transport** mode **ESP** with authentication is not compatible with NAT, although NAT traversal provides a way to use **Transport** mode **ESP** when there is a NAT router between the IPSec endpoints (See [Section 14.6 on page 237](#) for details).

Table 67 VPN and NAT

SECURITY PROTOCOL	MODE	NAT
AH	Transport	N
AH	Tunnel	N
ESP	Transport	N
ESP	Tunnel	Y

CHAPTER 14

VPN Screens

This chapter introduces the VPN Web Configurator. See [Chapter 24 on page 387](#) for information on viewing logs and [Appendix R on page 677](#) for IPSec log descriptions.

14.1 VPN/IPSec Overview

Use the screens documented in this chapter to configure rules for VPN connections and manage VPN connections.

14.2 IPSec Algorithms

The **ESP** and **AH** protocols are necessary to create a Security Association (SA), the foundation of an IPSec VPN. An SA is built from the authentication provided by the **AH** and **ESP** protocols. The primary function of key management is to establish and maintain the SA between systems. Once the SA is established, the transport of data may commence.

14.2.1 AH (Authentication Header) Protocol

AH protocol (RFC 2402) was designed for integrity, authentication, sequence integrity (replay resistance), and non-repudiation but not for confidentiality, for which the **ESP** was designed.

In applications where confidentiality is not required or not sanctioned by government encryption restrictions, an **AH** can be employed to ensure integrity. This type of implementation does not protect the information from dissemination but will allow for verification of the integrity of the information and authentication of the originator.

14.2.2 ESP (Encapsulating Security Payload) Protocol

The **ESP** protocol (RFC 2406) provides encryption as well as the services offered by **AH**. **ESP** authenticating properties are limited compared to the **AH** due to the non-inclusion of the IP header information during the authentication process. However, **ESP** is sufficient if only the upper layer protocols need to be authenticated.

An added feature of the **ESP** is payload padding, which further protects communications by concealing the size of the packet being transmitted.

Table 68 ESP and AH

	ESP	AH
Encryption	DES (default) Data Encryption Standard (DES) is a widely used method of data encryption using a secret key. DES applies a 56-bit key to each 64-bit block of data.	
	3DES Triple DES (3DES) is a variant of DES, which iterates three times with three separate keys (3 x 56 = 168 bits), effectively doubling the strength of DES.	
	AES Advanced Encryption Standard is a newer method of data encryption that also uses a secret key. This implementation of AES applies a 128-bit key to 128-bit blocks of data. AES is faster than 3DES.	
	Select NULL to set up a phase 2 tunnel without encryption.	
Authentication	MD5 (default) MD5 (Message Digest 5) produces a 128-bit digest to authenticate packet data.	MD5 (default) MD5 (Message Digest 5) produces a 128-bit digest to authenticate packet data.
	SHA1 SHA1 (Secure Hash Algorithm) produces a 160-bit digest to authenticate packet data.	SHA1 SHA1 (Secure Hash Algorithm) produces a 160-bit digest to authenticate packet data.
	Select MD5 for minimal security and SHA-1 for maximum security.	

14.3 My ZyWALL

My ZyWALL identifies the WAN IP address or domain name of the ZyWALL (if it has one) or leave the field set to **0.0.0.0**. The ZyWALL has to rebuild the VPN tunnel if the **My ZyWALL** IP address changes after setup.

14.4 Remote Gateway Address

Remote Gateway Address is the WAN IP address or domain name of the remote IPSec router (secure gateway).

If the remote secure gateway has a static WAN IP address, enter it in the **Remote Gateway Address** field. You may alternatively enter the remote secure gateway's domain name (if it has one).

You can also enter a remote secure gateway's domain name in the **Remote Gateway Address** field if the remote secure gateway has a dynamic WAN IP address and is using DDNS. The ZyWALL has to rebuild the VPN tunnel each time the remote secure gateway's WAN IP address changes (there may be a delay until the DDNS servers are updated with the remote gateway's new WAN IP address).

14.4.1 Dynamic Remote Gateway Address

If the remote secure gateway has a dynamic WAN IP address and does not use DDNS, enter 0.0.0.0 as the remote gateway's address. In this case only the remote secure gateway can initiate SAs. This may be useful for telecommuters initiating a VPN tunnel to the company network. See [Section 14.16 on page 264](#) for configuration examples.

Note: The **Remote Gateway Address** may be configured as **0.0.0.0** only when using **IKE** key management and not **Manual** key management.

14.5 Nailed Up

When you initiate an IPSec tunnel with nailed up enabled, the ZyWALL automatically renegotiates the tunnel when the IPSec SA lifetime period expires (see [Section 14.8 on page 240](#) for more on the IPSec SA lifetime). In effect, the IPSec tunnel becomes an always on connection after you initiate it. Both IPSec routers must have a ZyWALL-compatible nailed up feature enabled in order for this feature to work.

If the ZyWALL has its maximum number of simultaneous IPSec tunnels connected to it and they all have nailed up enabled, then no other tunnels can take a turn connecting to the ZyWALL because the ZyWALL never drops the tunnels that are already connected.

Note: When there is outbound traffic with no inbound traffic, the ZyWALL automatically drops the tunnel after two minutes.

14.6 NAT Traversal

NAT traversal allows you to set up a VPN connection when there are NAT routers between the two IPSec routers.

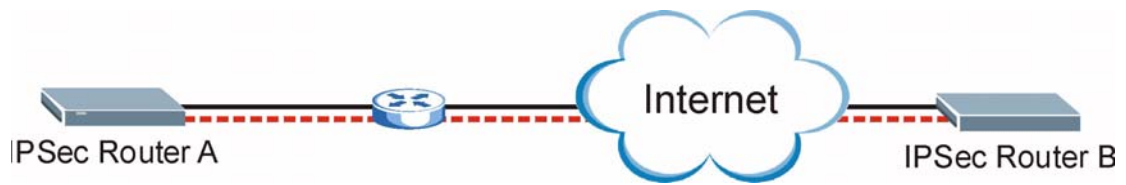
Figure 107 NAT Router Between IPSec Routers

Normally you cannot set up a VPN connection with a NAT router between the two IPSec routers because the NAT router changes the header of the IPSec packet. In the previous figure, IPSec router A sends an IPSec packet in an attempt to initiate a VPN. The NAT router changes the IPSec packet's header so it does not match the header for which IPSec router B is checking. Therefore, IPSec router B does not respond and the VPN connection cannot be built.

NAT traversal solves the problem by adding a UDP port 500 header to the IPSec packet. The NAT router forwards the IPSec packet with the UDP port 500 header unchanged. IPSec router B checks the UDP port 500 header and responds. IPSec routers A and B build a VPN connection.

14.6.1 NAT Traversal Configuration

For NAT traversal to work you must:

- Use ESP security protocol (in either transport or tunnel mode).
- Use IKE keying mode.
- Enable NAT traversal on both IPSec endpoints.

In order for IPSec router A (see [Figure 107 on page 238](#)) to receive an initiating IPSec packet from IPSec router B, set the NAT router to forward UDP port 500 to IPSec router A.

14.7 ID Type and Content

With aggressive negotiation mode (see [Section 14.8.1 on page 241](#)), the ZyWALL identifies incoming SAs by ID type and content since this identifying information is not encrypted. This enables the ZyWALL to distinguish between multiple rules for SAs that connect from remote IPSec routers that have dynamic WAN IP addresses. Telecommuters can use separate passwords to simultaneously connect to the ZyWALL from IPSec routers with dynamic IP addresses (see [Section 14.16.2 on page 264](#) for a telecommuter configuration example).

Note: Regardless of the ID type and content configuration, the ZyWALL does not allow you to save multiple active rules with overlapping local and remote IP addresses.

With main mode (see [Section 14.8.1 on page 241](#)), the ID type and content are encrypted to provide identity protection. In this case the ZyWALL can only distinguish between up to 12 different incoming SAs that connect from remote IPSec routers that have dynamic WAN IP addresses. The ZyWALL can distinguish up to 12 incoming SAs because you can select

between three encryption algorithms (DES, 3DES and AES), two authentication algorithms (MD5 and SHA1) and two key groups (DH1 and DH2) when you configure a VPN rule (see [Section 14.12.2 on page 251](#)). The ID type and content act as an extra level of identification for incoming SAs.

The type of ID can be a domain name, an IP address or an e-mail address. The content is the IP address, domain name, or e-mail address.

Table 69 Local ID Type and Content Fields

LOCAL ID TYPE=	CONTENT=
IP	Type the IP address of your computer or leave the field blank to have the ZyWALL automatically use its own IP address.
DNS	Type a domain name (up to 31 characters) by which to identify this ZyWALL.
E-mail	Type an e-mail address (up to 31 characters) by which to identify this ZyWALL.
The domain name or e-mail address that you use in the Content field is used for identification purposes only and does not need to be a real domain name or e-mail address.	

Table 70 Peer ID Type and Content Fields

PEER ID TYPE=	CONTENT=
IP	Type the IP address of the computer with which you will make the VPN connection or leave the field blank to have the ZyWALL automatically use the address in the Remote Gateway Address field.
DNS	Type a domain name (up to 31 characters) by which to identify the remote IPsec router.
E-mail	Type an e-mail address (up to 31 characters) by which to identify the remote IPsec router.
Subject Name	Type the subject name (up to 255 characters) by which to identify the remote IPsec router. This option is available only when you set Authentication Key to Certificate .
The domain name or e-mail address that you use in the Content field is used for identification purposes only and does not need to be a real domain name or e-mail address. The domain name also does not have to match the remote router's IP address or what you configure in the Remote Gateway Address field below.	

14.7.1 ID Type and Content Examples

Two IPsec routers must have matching ID type and content configuration in order to set up a VPN tunnel.

The two ZyWALLs in this example can complete negotiation and establish a VPN tunnel.

Table 71 Matching ID Type and Content Configuration Example

ZYWALL A	ZYWALL B
Local ID type: E-mail	Local ID type: IP
Local ID content: tom@yourcompany.com	Local ID content: 1.1.1.2

Table 71 Matching ID Type and Content Configuration Example

ZYWALL A	ZYWALL B
Peer ID type: IP	Peer ID type: E-mail
Peer ID content: 1.1.1.2	Peer ID content: tom@yourcompany.com

The two ZyWALLs in this example cannot complete their negotiation because ZyWALL B's **Local ID type** is **IP**, but ZyWALL A's **Peer ID type** is set to **E-mail**. An ID mismatched message displays in the IPSec log.

Table 72 Mismatching ID Type and Content Configuration Example

ZYWALL A	ZYWALL B
Local ID type: IP	Local ID type: IP
Local ID content: 1.1.1.10	Local ID content: 1.1.1.10
Peer ID type: E-mail	Peer ID type: IP
Peer ID content: aa@yahoo.com	Peer ID content: N/A

14.8 IKE Phases

There are two phases to every IKE (Internet Key Exchange) negotiation – phase 1 (Authentication) and phase 2 (Key Exchange). A phase 1 exchange establishes an IKE SA and the second one uses that SA to negotiate SAs for IPSec.

Figure 108 Two Phases to Set Up the IPSec SA

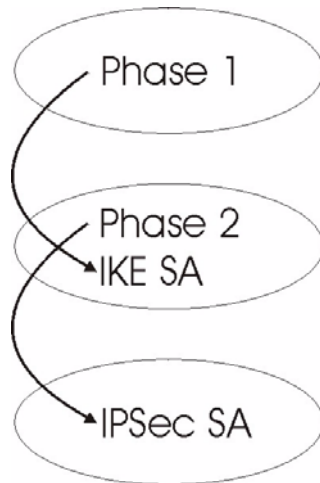

In phase 1 you must:

- Choose a negotiation mode.
- Authenticate the connection by entering a pre-shared key.
- Choose an encryption algorithm.

- Choose an authentication algorithm.
- Choose a Diffie-Hellman public-key cryptography key group (**DH1** or **DH2**).
- Set the IKE SA lifetime. This field allows you to determine how long an IKE SA should stay up before it times out. An IKE SA times out when the IKE SA lifetime period expires. If an IKE SA times out when an IPSec SA is already established, the IPSec SA stays connected.

In phase 2 you must:

- Choose which protocol to use (**ESP** or **AH**) for the IKE key exchange.
- Choose an encryption algorithm.
- Choose an authentication algorithm
- Choose whether to enable Perfect Forward Secrecy (PFS) using Diffie-Hellman public-key cryptography – see [Section 14.8.4 on page 242](#). Select **None** (the default) to disable PFS.
- Choose **Tunnel** mode or **Transport** mode.
- Set the IPSec SA lifetime. This field allows you to determine how long the IPSec SA should stay up before it times out. The ZyWALL automatically renegotiates the IPSec SA if there is traffic when the IPSec SA lifetime period expires. The ZyWALL also automatically renegotiates the IPSec SA if both IPSec routers have keep alive enabled, even if there is no traffic. If an IPSec SA times out, then the IPSec router must renegotiate the SA the next time someone attempts to send traffic.

14.8.1 Negotiation Mode

The phase 1 **Negotiation Mode** you select determines how the Security Association (SA) will be established for each connection through IKE negotiations.

- **Main Mode** ensures the highest level of security when the communicating parties are negotiating authentication (phase 1). It uses 6 messages in three round trips: SA negotiation, Diffie-Hellman exchange and an exchange of nonces (a nonce is a random number). This mode features identity protection (your identity is not revealed in the negotiation).
- **Aggressive Mode** is quicker than **Main Mode** because it eliminates several steps when the communicating parties are negotiating authentication (phase 1). However the trade-off is that faster speed limits its negotiating power and it also does not provide identity protection. It is useful in remote access situations where the address of the initiator is not known by the responder and both parties want to use pre-shared key authentication.

14.8.2 Pre-Shared Key

A pre-shared key identifies a communicating party during a phase 1 IKE negotiation. It is called pre-shared because you have to share it with another party before you can communicate with them over a secure connection.

14.8.3 Diffie-Hellman (DH) Key Groups

Diffie-Hellman (DH) is a public-key cryptography protocol that allows two parties to establish a shared secret over an unsecured communications channel. Diffie-Hellman is used within IKE SA setup to establish session keys. 768-bit (Group 1 - **DH1**) and 1024-bit (Group 2 – **DH2**) Diffie-Hellman groups are supported. Upon completion of the Diffie-Hellman exchange, the two peers have a shared secret, but the IKE SA is not authenticated. For authentication, use pre-shared keys.

14.8.4 Perfect Forward Secrecy (PFS)

Enabling PFS means that the key is transient. The key is thrown away and replaced by a brand new key using a new Diffie-Hellman exchange for each new IPSec SA setup. With PFS enabled, if one key is compromised, previous and subsequent keys are not compromised, because subsequent keys are not derived from previous keys. The (time-consuming) Diffie-Hellman exchange is the trade-off for this extra security.

This may be unnecessary for data that does not require such security, so PFS is disabled (**None**) by default in the ZyWALL. Disabling PFS means new authentication and encryption keys are derived from the same root secret (which may have security implications in the long run) but allows faster SA setup (by bypassing the Diffie-Hellman key exchange).

14.9 X-Auth (Extended Authentication)

Extended authentication provides added security by allowing you to use usernames and passwords for VPN connections. This is especially helpful when multiple ZyWALLs use one VPN rule to connect to a single ZyWALL. An attacker cannot make a VPN connection without a valid username and password.

The extended authentication server checks the user names and passwords of the extended authentication clients before completing the IPSec connection (see [Chapter 6 on page 109](#)).

A ZyWALL can be an extended authentication server for some VPN connections and an extended authentication client for other VPN connections.











14.9.1 Authentication Server

A ZyWALL set to be a VPN extended authentication server can use either the local user database internal to the ZyWALL or an external RADIUS server for an unlimited number of users. The ZyWALL uses the same local user database for VPN extended authentication and wireless LAN security.

14.10 Icons Key

The following table describes the icons used in the VPN screens.

Table 73 VPN screen Icons Key

ICON	DESCRIPTION
	This represents your ZyWALL.
	This represents the remote secure gateway.
	This represents the local network.
	This represents the remote network.
	Click this icon to add a VPN gateway policy (or IPSec rule).
	Click this icon to add a VPN network policy.
	Click this icon to display a screen in which you can associate a network policy to a gateway policy.
	Click this icon to display a screen in which you can change the settings of a gateway or network policy.
	Click this icon to delete a gateway or network policy. When you delete a gateway policy, the [Product Name (short)] automatically deletes the network policy(ies) associated to that gateway policy.
	Click this icon to establish a VPN connection to a remote network.
	This indicates that a gateway or network policy is not active.

14.11 IPSec Fields Summary

A VPN (Virtual Private Network) tunnel gives you a secure connection to another computer or network.

A gateway policy identifies the IPSec routers at either end of a VPN tunnel and specifies the authentication, encryption and other settings needed to negotiate a phase 1 IKE SA.

A network policy identifies the devices behind the IPSec routers at either end of a VPN tunnel and specifies the authentication, encryption and other settings needed to negotiate a phase 2 IPSec SA.

Figure 109 Gateway and Network Policies

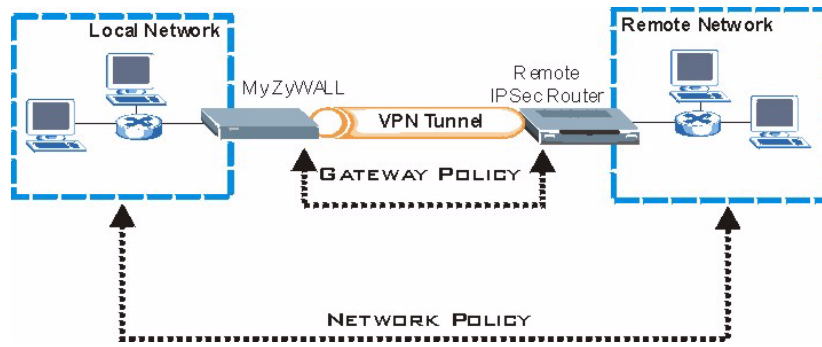

This figure helps explain the main fields in the VPN setup.

Figure 110 IPsec Fields Summary

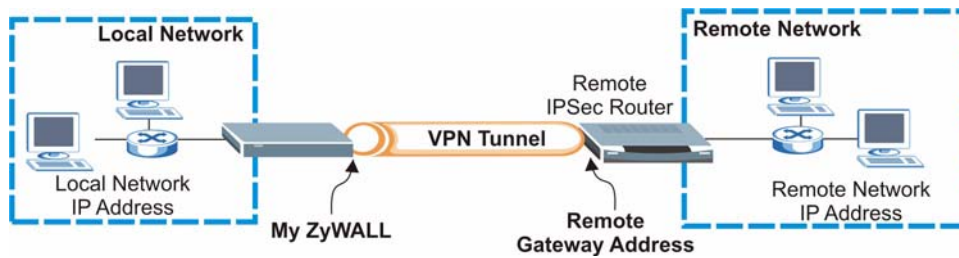

Note: Local and remote network IP addresses must be static.

14.12 IKE VPN Rule Summary Screen

Click **VPN** to display the **VPN Rules (IKE)** screen. This is a read-only menu of your IPsec rule (tunnel). To add an IPsec rule (or gateway policy), click the add gateway policy (🔑) icon. Edit an IPsec rule by clicking the edit (✎) icon to configure the associated submenus.

Refer to [Table 73 on page 243](#) for descriptions of the icons used in this screen.

Figure 111 VPN Rules (IKE)

VPN

VPN Rules (IKE) | VPN Rules (Manual) | SA Monitor | Global Setting

VPN Rules

#	VPN Rules				
1	test2	0.0.0.0	Dynamic		
	ex2	0.0.0.0	Any		
	ex3	1.0.0.0 / 255.0.0.0	Any		
2	ToZW2K	172.22.2.155	172.21.1.28		
	ex1	192.168.2.33	192.168.1.33 / 255.255.255.0		
3	Recycle Bin				
	ex	10.2.1.35	0.0.0.0		

Note: The **Recycle Bin** gateway policy is a virtual placeholder for any network policy(ies) without an associated gateway policy. When there is a network policy in the **Recycle Bin**, the **Recycle Bin** gateway policy automatically displays in this screen. See [Section 14.12.2.1 on page 255](#) for more information.

14.12.1 Configuring an IKE Gateway Policy



In the **VPN Rule (IKE)** screen, click the add gateway policy () icon or the edit () icon to display the **VPN-Gateway Policy -Edit** screen.

Figure 112 VPN Rules (IKE): Gateway Policy: Edit

VPN - GATEWAY POLICY - EDIT

Property

Name

NAT Traversal

Gateway Policy Information

My ZyWALL

My Address (Domain Name or IP Address)

My Domain Name (See [DDNS](#))

Remote Gateway Address

Authentication Key

Pre-Shared Key

Certificate (See [My Certificates](#))

Local ID Type

Content

Peer ID Type

Content

Extended Authentication

Enable Extended Authentication

Server Mode (Search [Local User](#) first then [RADIUS](#))

Client Mode

User Name

Password

IKE Proposal

Negotiation Mode

Encryption Algorithm

Authentication Algorithm

SA Life Time (Seconds)

Key Group

Enable Multiple Proposals

Associated Network Policies

#	Name	Local Network	Remote Network
1	test	172.11.1.3	192.168.2.33

The following table describes the labels in this screen.

Table 74 VPN Rules (IKE): Gateway Policy: Edit

LABEL	DESCRIPTION
Property	
Name	Type up to 32 characters to identify this VPN gateway policy. You may use any character, including spaces, but the ZyWALL drops trailing spaces.
NAT Traversal	<p>Select this check box to enable NAT traversal. NAT traversal allows you to set up a VPN connection when there are NAT routers between the two IPSec routers.</p> <p>Note: The remote IPSec router must also have NAT traversal enabled. See Section 14.6 on page 237 for more information.</p> <p>You can use NAT traversal with ESP protocol using Transport or Tunnel mode, but not with AH protocol nor with manual key management. In order for an IPSec router behind a NAT router to receive an initiating IPSec packet, set the NAT router to forward UDP port 500 to the IPSec router behind the NAT router.</p>
Gateway Policy Information	
My ZyWALL	<p>This field identifies the WAN IP address or domain name of the ZyWALL. You can select My Address and enter the ZyWALL's static WAN IP address (if it has one) or leave the field set to 0.0.0.0.</p> <p>The following applies if the My ZyWALL field is configured as 0.0.0.0:</p> <ul style="list-style-type: none"> • When the WAN port operation mode is set to Active/Passive, the ZyWALL uses the IP address (static or dynamic) of the WAN port that is in use. • When the WAN port operation mode is set to Active/Active, the ZyWALL uses the IP address (static or dynamic) of the primary (highest priority) WAN port to set up the VPN tunnel as long as the corresponding WAN1 or WAN2 connection is up. If the corresponding WAN1 or WAN2 connection goes down, the ZyWALL uses the IP address of the other WAN port. • If both WAN connections go down, the ZyWALL uses the dial backup IP address for the VPN tunnel when using dial backup or the LAN IP address when using traffic redirect. See the chapter on WAN for details on dial backup and traffic redirect. <p>Otherwise you can select My Domain Name and choose one of the dynamic domain names that you have configured (in the DDNS screen) to have the ZyWALL use that dynamic domain name's IP address.</p> <p>The VPN tunnel has to be rebuilt if the My ZyWALL IP address changes after setup.</p>
Remote Gateway Address	<p>Type the WAN IP address or the domain name (up to 31 characters) of the IPSec router with which you're making the VPN connection. Set this field to 0.0.0.0 if the remote IPSec router has a dynamic WAN IP address.</p> <p>In order to have more than one active rule with the Remote Gateway Address field set to 0.0.0.0, the ranges of the local IP addresses cannot overlap between rules.</p> <p>If you configure an active rule with 0.0.0.0 in the Remote Gateway Address field and the LAN's full IP address range as the local IP address, then you cannot configure any other active rules with the Remote Gateway Address field set to 0.0.0.0.</p>
Authentication Key	

Table 74 VPN Rules (IKE): Gateway Policy: Edit (continued)

LABEL	DESCRIPTION
Pre-Shared Key	<p>Select the Pre-Shared Key radio button and type your pre-shared key in this field. A pre-shared key identifies a communicating party during a phase 1 IKE negotiation. It is called "pre-shared" because you have to share it with another party before you can communicate with them over a secure connection.</p> <p>Type from 8 to 31 case-sensitive ASCII characters or from 16 to 62 hexadecimal ("0-9", "A-F") characters. You must precede a hexadecimal key with a "0x (zero x)", which is not counted as part of the 16 to 62 character range for the key. For example, in "0x0123456789ABCDEF", 0x denotes that the key is hexadecimal and 0123456789ABCDEF is the key itself.</p> <p>Both ends of the VPN tunnel must use the same pre-shared key. You will receive a PYLD_MALFORMED (payload malformed) packet if the same pre-shared key is not used on both ends.</p>
Certificate	<p>Select the Certificate radio button to identify the ZyWALL by a certificate. Use the drop-down list box to select the certificate to use for this VPN tunnel. You must have certificates already configured in the My Certificates screen. Click My Certificates to go to the My Certificates screen where you can view the ZyWALL's list of certificates.</p>
Local ID Type	<p>Select IP to identify this ZyWALL by its IP address. Select DNS to identify this ZyWALL by a domain name. Select E-mail to identify this ZyWALL by an e-mail address.</p> <p>You do not configure the local ID type and content when you set Authentication Key to Certificate. The ZyWALL takes them from the certificate you select.</p>
Content	<p>When you select IP in the Local ID Type field, type the IP address of your computer in the local Content field. The ZyWALL automatically uses the IP address in the My ZyWALL field (refer to the My ZyWALL field description) if you configure the local Content field to 0.0.0.0 or leave it blank.</p> <p>It is recommended that you type an IP address other than 0.0.0.0 in the local Content field or use the DNS or E-mail ID type in the following situations.</p> <ul style="list-style-type: none"> • When there is a NAT router between the two IPSec routers. • When you want the remote IPSec router to be able to distinguish between VPN connection requests that come in from IPSec routers with dynamic WAN IP addresses. <p>When you select DNS or E-mail in the Local ID Type field, type a domain name or e-mail address by which to identify this ZyWALL in the local Content field. Use up to 31 ASCII characters including spaces, although trailing spaces are truncated. The domain name or e-mail address is for identification purposes only and can be any string.</p>
Peer ID Type	<p>Select from the following when you set Authentication Key to Pre-shared Key.</p> <ul style="list-style-type: none"> • Select IP to identify the remote IPSec router by its IP address. • Select DNS to identify the remote IPSec router by a domain name. • Select E-mail to identify the remote IPSec router by an e-mail address. <p>Select from the following when you set Authentication Key to Certificate.</p> <ul style="list-style-type: none"> • Select IP to identify the remote IPSec router by the IP address in the subject alternative name field of the certificate it uses for this VPN connection. • Select DNS to identify the remote IPSec router by the domain name in the subject alternative name field of the certificate it uses for this VPN connection. • Select E-mail to identify the remote IPSec router by the e-mail address in the subject alternative name field of the certificate it uses for this VPN connection. • Select Subject Name to identify the remote IPSec router by the subject name of the certificate it uses for this VPN connection. • Select Any to have the ZyWALL not check the remote IPSec router's ID.

Table 74 VPN Rules (IKE): Gateway Policy: Edit (continued)

LABEL	DESCRIPTION
Content	<p>The configuration of the peer content depends on the peer ID type.</p> <p>Do the following when you set Authentication Key to Pre-shared Key.</p> <ul style="list-style-type: none"> For IP, type the IP address of the computer with which you will make the VPN connection. If you configure this field to 0.0.0.0 or leave it blank, the ZyWALL will use the address in the Remote Gateway Address field (refer to the Remote Gateway Address field description). For DNS or E-mail, type a domain name or e-mail address by which to identify the remote IPSec router. Use up to 31 ASCII characters including spaces, although trailing spaces are truncated. The domain name or e-mail address is for identification purposes only and can be any string. <p>It is recommended that you type an IP address other than 0.0.0.0 or use the DNS or E-mail ID type in the following situations:</p> <ul style="list-style-type: none"> When there is a NAT router between the two IPSec routers. When you want the ZyWALL to distinguish between VPN connection requests that come in from remote IPSec routers with dynamic WAN IP addresses. <p>Do the following when you set Authentication Key to Certificate.</p> <ul style="list-style-type: none"> For IP, type the IP address from the subject alternative name field of the certificate the remote IPSec router will use for this VPN connection. If you configure this field to 0.0.0.0 or leave it blank, the ZyWALL will use the address in the Remote Gateway Address field (refer to the Remote Gateway Address field description). For DNS or E-mail, type the domain name or e-mail address from the subject alternative name field of the certificate the remote IPSec router will use for this VPN connection. For Subject Name, type the subject name of the certificate the remote IPSec router will use for this VPN connection. Use up to 255 ASCII characters including spaces. For Any, the peer Content field is not available. Regardless of how you configure the ID Type and Content fields, two active SAs cannot have both the local and remote IP address ranges overlap between rules.
Extended Authentication	
Enable Extended Authentication	Select this check box to activate extended authentication.
Server Mode	<p>Select Server Mode to have this ZyWALL authenticate extended authentication clients that request this VPN connection.</p> <p>You must also configure the extended authentication clients' usernames and passwords in the authentication server's local user database or a RADIUS server (see Chapter 6 on page 109).</p> <p>Click Local User to go to the Local User Database screen where you can view and/or edit the list of user names and passwords. Click RADIUS to go to the RADIUS screen where you can configure the ZyWALL to check an external RADIUS server.</p> <p>During authentication, if the ZyWALL (in server mode) does not find the extended authentication clients' user name in its internal user database and an external RADIUS server has been enabled, it attempts to authenticate the client through the RADIUS server.</p>
Client Mode	<p>Select Client Mode to have your ZyWALL use a username and password when initiating this VPN connection to the extended authentication server ZyWALL.</p> <p>Only a VPN extended authentication client can initiate this VPN connection.</p>

Table 74 VPN Rules (IKE): Gateway Policy: Edit (continued)

LABEL	DESCRIPTION
User Name	Enter a user name for your ZyWALL to be authenticated by the VPN peer (in server mode). The user name can be up to 31 case-sensitive ASCII characters, but spaces are not allowed. You must enter a user name and password when you select client mode.
Password	Enter the corresponding password for the above user name. The password can be up to 31 case-sensitive ASCII characters, but spaces are not allowed.
IKE Proposal	
Negotiation Mode	Select Main or Aggressive from the drop-down list box. Multiple SAs connecting through a secure gateway must have the same negotiation mode.
Encryption Algorithm	Select DES , 3DES or AES from the drop-down list box. When you use one of these encryption algorithms for data communications, both the sending device and the receiving device must use the same secret key, which can be used to encrypt and decrypt the message or to generate and verify a message authentication code. The DES encryption algorithm uses a 56-bit key. Triple DES (3DES) is a variation on DES that uses a 168-bit key. As a result, 3DES is more secure than DES . It also requires more processing power, resulting in increased latency and decreased throughput. This implementation of AES uses a 128-bit key. AES is faster than 3DES .
Authentication Algorithm	Select SHA1 or MD5 from the drop-down list box. MD5 (Message Digest 5) and SHA1 (Secure Hash Algorithm) are hash algorithms used to authenticate packet data. The SHA1 algorithm is generally considered stronger than MD5 , but is slower. Select MD5 for minimal security and SHA-1 for maximum security.
SA Life Time (Seconds)	Define the length of time before an IKE SA automatically renegotiates in this field. It may range from 180 to 3,000,000 seconds (almost 35 days). A short SA Life Time increases security by forcing the two VPN gateways to update the encryption and authentication keys. However, every time the VPN tunnel renegotiates, all users accessing remote resources are temporarily disconnected.
Key Group	You must choose a key group for phase 1 IKE setup. DH1 (default) refers to Diffie-Hellman Group 1 a 768 bit random number. DH2 refers to Diffie-Hellman Group 2 a 1024 bit (1Kb) random number.
Enable Multiple Proposals	Select this check box to allow the ZyWALL to use any of its phase 1 or phase 2 encryption and authentication algorithms when negotiating an IPSec SA. When you enable multiple proposals, the ZyWALL allows the remote IPSec router to select which encryption and authentication algorithms to use for the VPN tunnel, even if they are less secure than the ones you configure for the VPN rule. Clear this check box to have the ZyWALL use only the phase 1 or phase 2 encryption and authentication algorithms configured below when negotiating an IPSec SA.
Associated Network Policies	The following table shows the policy(ies) you configure for this rule. To add a VPN policy, click the add network policy () icon in the VPN Rules (IKE) screen (see Figure 111 on page 245). Refer to Section 14.12.2 on page 251 for more information.
#	This field displays the policy index number.
Name	This field displays the policy name.
Local Network	This field displays one or a range of IP address(es) of the computer(s) behind the ZyWALL.
Remote Network	This field displays one or a range of IP address(es) of the remote network behind the remote IPsec router.

Table 74 VPN Rules (IKE): Gateway Policy: Edit (continued)

LABEL	DESCRIPTION
Apply	Click Apply to save your changes back to the ZyWALL.
Cancel	Click Cancel to exit this screen without saving.

14.12.2 Configuring an IKE Network Policy

To configure a VPN policy, click **VPN** and the add network policy () icon in the **VPN Rules (IKE)** screen. A screen displays as follows.

Figure 113 VPN Rules (IKE): Network Policy Edit

VPN - NETWORK POLICY - EDIT

Property

Active
 Name
 Protocol
 Nailed-Up
 Allow NetBIOS Traffic Through IPSec Tunnel
 Check IPSec Tunnel Connectivity Log
 Ping this Address

Gateway Policy Information

Gateway Policy

Local Network

Address Type

Starting IP Address
 Ending IP Address / Subnet Mask
 Local Port Start End

Remote Network

Address Type

Starting IP Address
 Ending IP Address / Subnet Mask
 Remote Port Start End

IPSec Proposal

Encapsulation Mode
 Active Protocol
 Encryption Algorithm
 Authentication Algorithm
 SA Life Time (Seconds)
 Perfect Forward Secrecy (PFS)

Enable Replay Detection
 Enable Multiple Proposals

The following table describes the labels in this screen.

Table 75 VPN Rules (IKE): Network Policy Edit

LABEL	DESCRIPTION
Active	<p>If the Active check box is selected, packets for the tunnel trigger the ZyWALL to build the tunnel.</p> <p>Clear the Active check box to turn the network policy off. The ZyWALL does not apply the policy. Packets for the tunnel do not trigger the tunnel.</p> <p>If you clear the Active check box while the tunnel is up (and click Apply), you turn off the network policy and the tunnel goes down.</p>
Name	Type a name to identify this VPN network policy. You may use any character, including spaces, but the ZyWALL drops trailing spaces.
Protocol	Enter 1 for ICMP, 6 for TCP, 17 for UDP, etc. 0 is the default and signifies any protocol.
Nailed-Up	<p>Select this check box to turn on the nailed up feature for this SA.</p> <p>Turn on nailed up to have the ZyWALL automatically reinitiate the SA after the SA lifetime times out, even if there is no traffic. The ZyWALL also reinitiates the SA when it restarts.</p> <p>The ZyWALL also rebuilds the tunnel if it was disconnected due to the output or input idle timer.</p>
Allow NetBIOS Traffic Through IPsec Tunnel	<p>NetBIOS (Network Basic Input/Output System) are TCP or UDP packets that enable a computer to connect to and communicate with a LAN. It may sometimes be necessary to allow NetBIOS packets to pass through VPN tunnels in order to allow local computers to find computers on the remote network and vice versa.</p> <p>Select this check box to send NetBIOS packets through the VPN connection.</p>
Check IPsec Tunnel Connectivity	<p>Select the check box and configure an IP address in the Ping this Address field to have the ZyWALL periodically test the VPN tunnel to the remote IPsec router.</p> <p>The ZyWALL pings the IP address every minute. The ZyWALL starts the IPsec connection idle timeout timer when it sends the ping packet. If there is no traffic from the remote IPsec router by the time the timeout period expires, the ZyWALL disconnects the VPN tunnel.</p>
Log	Select this check box to set the ZyWALL to create logs when it cannot ping the remote device.
Ping this Address	If you select Check IPsec Tunnel Connectivity , enter the IP address of a computer at the remote IPsec network. The computer's IP address must be in this IP policy's remote range (see the Remote Network fields).
Gateway Policy Information	
Gateway Policy	Select the gateway policy with which you want to use the VPN policy.
Local Network	<p>Local IP addresses must be static and correspond to the remote IPsec router's configured remote IP addresses.</p> <p>Two active SAs cannot have the local and remote IP address(es) both the same. Two active SAs can have the same local or remote IP address, but not both. You can configure multiple SAs between the same local and remote IP addresses, as long as only one is active at any time.</p>
Address Type	Use the drop-down list box to choose Single Address , Range Address , or Subnet Address . Select Single Address for a single IP address. Select Range Address for a specific range of IP addresses. Select Subnet Address to specify IP addresses on a network by their subnet mask.

Table 75 VPN Rules (IKE): Network Policy Edit (continued)

LABEL	DESCRIPTION
Starting IP Address	When the Address Type field is configured to Single Address , enter a (static) IP address on the LAN behind your ZyWALL. When the Address Type field is configured to Range Address , enter the beginning (static) IP address, in a range of computers on the LAN behind your ZyWALL. When the Address Type field is configured to Subnet Address , this is a (static) IP address on the LAN behind your ZyWALL.
Ending IP Address/ Subnet Mask	When the Address Type field is configured to Single Address , this field is N/A. When the Address Type field is configured to Range Address , enter the end (static) IP address, in a range of computers on the LAN behind your ZyWALL. When the Address Type field is configured to Subnet Address , this is a subnet mask on the LAN behind your ZyWALL.
Local Port	0 is the default and signifies any port. Type a port number from 0 to 65535 in the Start and End fields. Some of the most common IP ports are: 21, FTP; 53, DNS; 23, Telnet; 80, HTTP; 25, SMTP; 110, POP3.
Remote Network	Remote IP addresses must be static and correspond to the remote IPSec router's configured local IP addresses. Two active SAs cannot have the local and remote IP address(es) both the same. Two active SAs can have the same local or remote IP address, but not both. You can configure multiple SAs between the same local and remote IP addresses, as long as only one is active at any time.
Address Type	Use the drop-down list box to choose Single Address , Range Address , or Subnet Address . Select Single Address with a single IP address. Select Range Address for a specific range of IP addresses. Select Subnet Address to specify IP addresses on a network by their subnet mask.
Starting IP Address	When the Address Type field is configured to Single Address , enter a (static) IP address on the network behind the remote IPSec router. When the Addr Type field is configured to Range Address , enter the beginning (static) IP address, in a range of computers on the network behind the remote IPSec router. When the Address Type field is configured to Subnet Address , enter a (static) IP address on the network behind the remote IPSec router.
Ending IP Address/ Subnet Mask	When the Address Type field is configured to Single Address , this field is N/A. When the Address Type field is configured to Range Address , enter the end (static) IP address, in a range of computers on the network behind the remote IPSec router. When the Address Type field is configured to Subnet Address , enter a subnet mask on the network behind the remote IPSec router.
Remote Port	0 is the default and signifies any port. Type a port number from 0 to 65535 in the Start and End fields. Some of the most common IP ports are: 21, FTP; 53, DNS; 23, Telnet; 80, HTTP; 25, SMTP; 110, POP3.
IPSec Proposal	
Encapsulation Mode	Select Tunnel mode or Transport mode.
Active Protocol	Select the security protocols used for an SA. Both AH and ESP increase [Product Family] processing requirements and communications latency (delay).
Encryption Algorithm	When DES is used for data communications, both sender and receiver must know the same secret key, which can be used to encrypt and decrypt the message or to generate and verify a message authentication code. The DES encryption algorithm uses a 56-bit key. Triple DES (3DES) is a variation on DES that uses a 168-bit key. As a result, 3DES is more secure than DES . It also requires more processing power, resulting in increased latency and decreased throughput. This implementation of AES uses a 128-bit key. AES is faster than 3DES . Select NULL to set up a tunnel without encryption. When you select NULL , you do not enter an encryption key.

Table 75 VPN Rules (IKE): Network Policy Edit (continued)

LABEL	DESCRIPTION
Authentication Algorithm	MD5 (Message Digest 5) and SHA1 (Secure Hash Algorithm) are hash algorithms used to authenticate packet data. The SHA1 algorithm is generally considered stronger than MD5 , but is slower. Select MD5 for minimal security and SHA-1 for maximum security.
SA Life Time (Seconds)	Define the length of time before an IKE SA automatically renegotiates in this field. The minimum value is 180 seconds. A short SA Life Time increases security by forcing the two VPN gateways to update the encryption and authentication keys. However, every time the VPN tunnel renegotiates, all users accessing remote resources are temporarily disconnected.
Perfect Forward Secret (PFS)	Perfect Forward Secret (PFS) is disabled (NONE) by default in phase 2 IPsec SA setup. This allows faster IPsec setup, but is not so secure. Select DH1 or DH2 to enable PFS. DH1 refers to Diffie-Hellman Group 1 a 768 bit random number. DH2 refers to Diffie-Hellman Group 2 a 1024 bit (1Kb) random number (more secure, yet slower).
Enable Replay Detection	As a VPN setup is processing intensive, the system is vulnerable to Denial of Service (DOS) attacks. The IPsec receiver can detect and reject old or duplicate packets to protect against replay attacks. Enable replay detection by selecting this check box.
Enable Multiple Proposals	Select this check box to allow the ZyWALL to use any of its phase 1 or phase 2 encryption and authentication algorithms when negotiating an IPsec SA. When you enable multiple proposals, the ZyWALL allows the remote IPsec router to select which encryption and authentication algorithms to use for the VPN tunnel, even if they are less secure than the ones you configure for the VPN rule. Clear this check box to have the ZyWALL use only the phase 1 or phase 2 encryption and authentication algorithms configured below when negotiating an IPsec SA.
Apply	Click Apply to save the changes.
Cancel	Click Cancel to discard all changes and return to the main VPN screen.

14.12.2.1 Associating a Network Policy to a Gateway Policy

To associate a network policy to a gateway rule, click the move () icon in the **VPN Rules (IKE)** screen. A screen displays as shown below.

Figure 114 VPN Rules (IKE): Network Policy Move



The following table describes the labels in this screen.

Table 76 VPN Rules (IKE): Network Policy Move

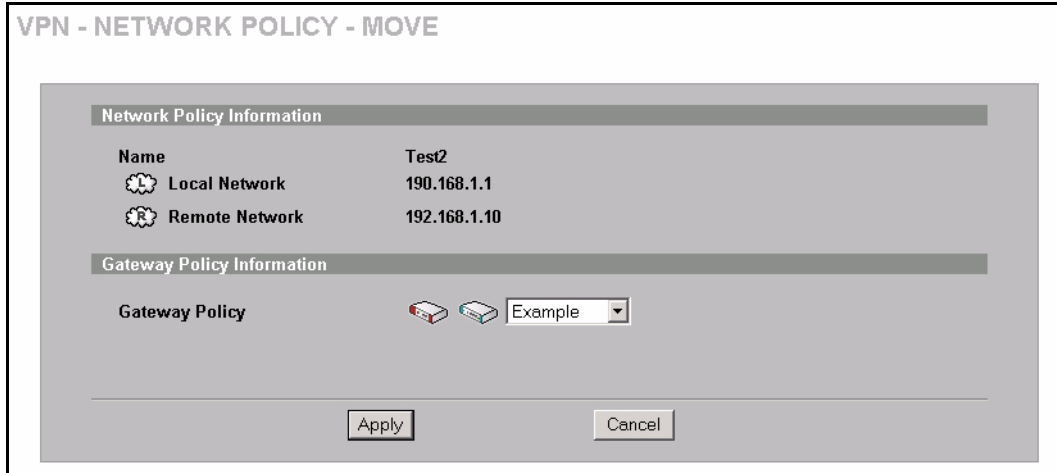
LABEL	DESCRIPTION
Network Policy Information	The following fields display the general network settings of this VPN policy.
Name	This field displays the policy name.
Local Network	This field displays one or a range of IP address(es) of the computer(s) behind the ZyWALL.
Remote Network	This field displays one or a range of IP address(es) of the remote network behind the remote IPsec router.
Gateway Policy Information	
Gateway Policy	Select the name of a VPN rule (or gateway policy) to which you want to associate this VPN network policy. If you do not want to associate a network policy to any gateway policy, select Recycle Bin from the drop-down list box. The Recycle Bin gateway policy is a virtual placeholder for any network policy(ies) without an associated gateway policy. When there is a network policy in Recycle Bin , the Recycle Bin gateway policy automatically displays in the VPN Rules (IKE) screen.
Apply	Click Apply to save the changes.
Cancel	Click Cancel to discard all changes and return to the main VPN screen.

14.13 Manual VPN Rule Summary Screen

Refer to [Figure 110 on page 244](#) for a graphical representation of the fields in the web configurator.

Click **VPN** and the **VPN Rules (Manual)** tab to open the **VPN Rules** screen. This is a read-only menu of your IPsec rules (tunnels). Edit an IPsec rule by clicking the edit icon to configure the associated submenus.

Refer to [Table 73 on page 243](#) for descriptions of the icons used in this screen.

Figure 115 VPN Rule (Manual)

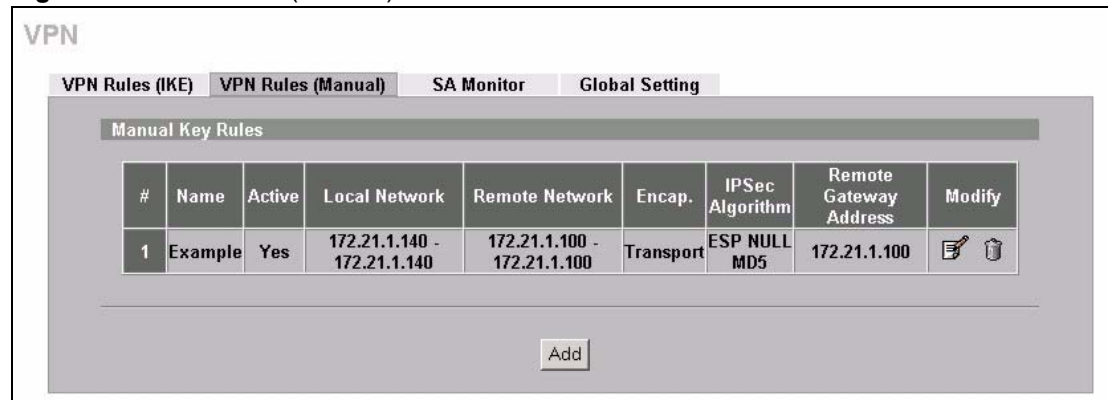

The following table describes the labels in this screen.

Table 77 VPN Rules (Manual)

LABEL	DESCRIPTION
#	This is the VPN policy index number.
Name	This field displays the identification name for this VPN policy.
Active	This field displays whether the VPN policy is active or not. A Yes signifies that this VPN policy is active. No signifies that this VPN policy is not active.
Local Network	This is the IP address(es) of computer(s) on your local network behind your ZyWALL. The same (static) IP address is displayed twice when the Local Network Address Type field in the VPN - Manual Key - Edit screen is configured to Single Address . The beginning and ending (static) IP addresses, in a range of computers are displayed when the Local Network Address Type field in the VPN - Manual Key - Edit screen is configured to Range Address . A (static) IP address and a subnet mask are displayed when the Local Network Address Type field in the VPN - Manual Key - Edit screen is configured to Subnet Address .
Remote Network	This is the IP address(es) of computer(s) on the remote network behind the remote IPSec router. This field displays N/A when the Remote Gateway Address field displays 0.0.0.0 . In this case only the remote IPSec router can initiate the VPN. The same (static) IP address is displayed twice when the Remote Network Address Type field in the VPN - Manual Key - Edit screen is configured to Single Address . The beginning and ending (static) IP addresses, in a range of computers are displayed when the Remote Network Address Type field in the VPN - Manual Key - Edit screen is configured to Range Address . A (static) IP address and a subnet mask are displayed when the Remote Network Address Type field in the VPN - Manual Key - Edit screen is configured to Subnet Address .
Encap.	This field displays Tunnel or Transport mode (Tunnel is the default selection).
IPSec Algorithm	This field displays the security protocols used for an SA. Both AH and ESP increase ZyWALL processing requirements and communications latency (delay).

Table 77 VPN Rules (Manual) (continued)

LABEL	DESCRIPTION
Remote Gateway Address	This is the static WAN IP address or domain name of the remote IPSec router.
Modify	Click the edit icon to edit the VPN policy. Click the delete icon to remove the VPN policy. A window displays asking you to confirm that you want to delete the VPN rule. When a VPN policy is deleted, subsequent policies move up in the page list. Click the dial icon to dial up the connection manually. If a VPN tunnel has been built and dialed up, every time you click this icon, a warning message appears in the status bar on the bottom of the screen.
Add	Click Add to add a new VPN policy.

14.13.1 Editing Manual VPN Rules

Manual key management is useful if you have problems with IKE key management.

14.13.2 Security Parameter Index (SPI)

An SPI is used to distinguish different SAs terminating at the same destination and using the same IPSec protocol. This data allows for the multiplexing of SAs to a single gateway. The **SPI** (Security Parameter Index) along with a destination IP address uniquely identify a particular Security Association (SA). The **SPI** is transmitted from the remote VPN gateway to the local VPN gateway. The local VPN gateway then uses the network, encryption and key values that the administrator associated with the SPI to establish the tunnel.

Note: Current ZyXEL implementation assumes identical outgoing and incoming SPIs.

Click the edit icon on the **VPN Rules (Manual)** screen to edit VPN rules.

Figure 116 VPN Rules (Manual): Edit

The following table describes the labels in this screen.

Table 78 VPN Rules (Manual) Edit

LABEL	DESCRIPTION
Property	
Active	Select this check box to activate this VPN policy.
Name	Type up to 32 characters to identify this VPN policy. You may use any character, including spaces, but the ZyWALL drops trailing spaces.
Allow NetBIOS Traffic Through IPSec Tunnel	NetBIOS (Network Basic Input/Output System) are TCP or UDP packets that enable a computer to find other computers. It may sometimes be necessary to allow NetBIOS packets to pass through VPN tunnels in order to allow local computers to find computers on the remote network and vice versa. Select this check box to send NetBIOS packets through the VPN connection.

Table 78 VPN Rules (Manual) Edit (continued)

LABEL	DESCRIPTION
Local Network	<p>Local IP addresses must be static and correspond to the remote IPSec router's configured remote IP addresses.</p> <p>Two active SAs cannot have the local and remote IP address(es) both the same. Two active SAs can have the same local or remote IP address, but not both. You can configure multiple SAs between the same local and remote IP addresses, as long as only one is active at any time.</p>
Address Type	<p>Use the drop-down list box to choose Single Address, Range Address, or Subnet Address. Select Single Address for a single IP address. Select Range Address for a specific range of IP addresses. Select Subnet Address to specify IP addresses on a network by their subnet mask.</p>
Starting IP Address	<p>When the Address Type field is configured to Single Address, enter a (static) IP address on the LAN behind your ZyWALL. When the Address Type field is configured to Range Address, enter the beginning (static) IP address, in a range of computers on the LAN behind your ZyWALL. When the Address Type field is configured to Subnet Address, this is a (static) IP address on the LAN behind your ZyWALL.</p>
Ending IP Address/Subnet Mask	<p>When the Address Type field is configured to Single Address, this field is N/A. When the Address Type field is configured to Range Address, enter the end (static) IP address, in a range of computers on the LAN behind your ZyWALL. When the Address Type field is configured to Subnet Address, this is a subnet mask on the LAN behind your ZyWALL.</p>
Remote Network	<p>Remote IP addresses must be static and correspond to the remote IPSec router's configured local IP addresses.</p> <p>Two active SAs cannot have the local and remote IP address(es) both the same. Two active SAs can have the same local or remote IP address, but not both. You can configure multiple SAs between the same local and remote IP addresses, as long as only one is active at any time.</p>
Address Type	<p>Use the drop-down list box to choose Single Address, Range Address, or Subnet Address. Select Single Address with a single IP address. Select Range Address for a specific range of IP addresses. Select Subnet Address to specify IP addresses on a network by their subnet mask.</p>
Starting IP Address	<p>When the Address Type field is configured to Single Address, enter a (static) IP address on the network behind the remote IPSec router. When the Addr Type field is configured to Range Address, enter the beginning (static) IP address, in a range of computers on the network behind the remote IPSec router. When the Address Type field is configured to Subnet Address, enter a (static) IP address on the network behind the remote IPSec router.</p>
Ending IP Address/Subnet Mask	<p>When the Address Type field is configured to Single Address, this field is N/A. When the Address Type field is configured to Range Address, enter the end (static) IP address, in a range of computers on the network behind the remote IPSec router. When the Address Type field is configured to Subnet Address, enter a subnet mask on the network behind the remote IPSec router.</p>
Gateway Policy Information	

Table 78 VPN Rules (Manual) Edit (continued)

LABEL	DESCRIPTION
My ZyWALL	<p>Enter the WAN IP address or domain name of your ZyWALL or leave the field set to 0.0.0.0. The VPN tunnel has to be rebuilt if the My ZyWALL IP address changes after setup.</p> <p>The following applies if the My ZyWALL field is configured as 0.0.0.0:</p> <ul style="list-style-type: none"> • When the WAN port operation mode is set to Active/Passive, the ZyWALL uses the IP address (static or dynamic) of the WAN port that is in use. • When the WAN port operation mode is set to Active/Active, the ZyWALL uses the IP address (static or dynamic) of the primary (highest priority) WAN port to set up the VPN tunnel as long as the corresponding WAN1 or WAN2 connection is up. If the corresponding WAN1 or WAN2 connection goes down, the ZyWALL uses the IP address of the other WAN port. • If both WAN connections go down, the ZyWALL uses the dial backup IP address for the VPN tunnel when using dial backup or the LAN IP address when using traffic redirect. See the chapter on WAN for details on dial backup and traffic redirect.
Remote Gateway Addr	Type the WAN IP address or the domain name (up to 31 characters) of the IPSec router with which you're making the VPN connection.
Manual Proposal	
SPI	Type a unique SPI (Security Parameter Index) from one to four characters long. Valid Characters are "0, 1, 2, 3, 4, 5, 6, 7, 8, and 9".
Encapsulation Mode	Select Tunnel mode or Transport mode from the drop-down list box.
Active Protocol	<p>Select ESP if you want to use ESP (Encapsulation Security Payload). The ESP protocol (RFC 2406) provides encryption as well as some of the services offered by AH. If you select ESP here, you must select options from the Encryption Algorithm and Authentication Algorithm fields (described next).</p> <p>Select AH if you want to use AH (Authentication Header Protocol). The AH protocol (RFC 2402) was designed for integrity, authentication, sequence integrity (replay resistance), and non-repudiation but not for confidentiality, for which the ESP was designed. If you select AH here, you must select options from the Authentication Algorithm field (described next).</p>
Encryption Algorithm	<p>Select DES, 3DES or NULL from the drop-down list box.</p> <p>When DES is used for data communications, both sender and receiver must know the Encryption Key, which can be used to encrypt and decrypt the message or to generate and verify a message authentication code. The DES encryption algorithm uses a 56-bit key. Triple DES (3DES) is a variation on DES that uses a 168-bit key. As a result, 3DES is more secure than DES. It also requires more processing power, resulting in increased latency and decreased throughput. Select NULL to set up a tunnel without encryption. When you select NULL, you do not enter an encryption key.</p>
Authentication Algorithm	Select SHA1 or MD5 from the drop-down list box. MD5 (Message Digest 5) and SHA1 (Secure Hash Algorithm) are hash algorithms used to authenticate packet data. The SHA1 algorithm is generally considered stronger than MD5 , but is slower. Select MD5 for minimal security and SHA-1 for maximum security.
Encryption Key	<p>This field is applicable when you select ESP in the Active Protocol field above.</p> <p>With DES, type a unique key 8 characters long. With 3DES, type a unique key 24 characters long. Any characters may be used, including spaces, but trailing spaces are truncated.</p>
Authentication Key	Type a unique authentication key to be used by IPSec if applicable. Enter 16 characters for MD5 authentication or 20 characters for SHA-1 authentication. Any characters may be used, including spaces, but trailing spaces are truncated.

Table 78 VPN Rules (Manual) Edit (continued)

LABEL	DESCRIPTION
Apply	Click Apply to save your changes back to the ZyWALL.
Cancel	Click Cancel to exit this screen without saving.

14.14 Viewing SA Monitor

In the web configurator, click **VPN** and the **SA Monitor** tab. Use this screen to display and manage active VPN connections.

A Security Association (SA) is the group of security settings related to a specific VPN tunnel. This screen displays active VPN connections. Use **Refresh** to display active VPN connections. This screen is read-only. The following table describes the fields in this tab.

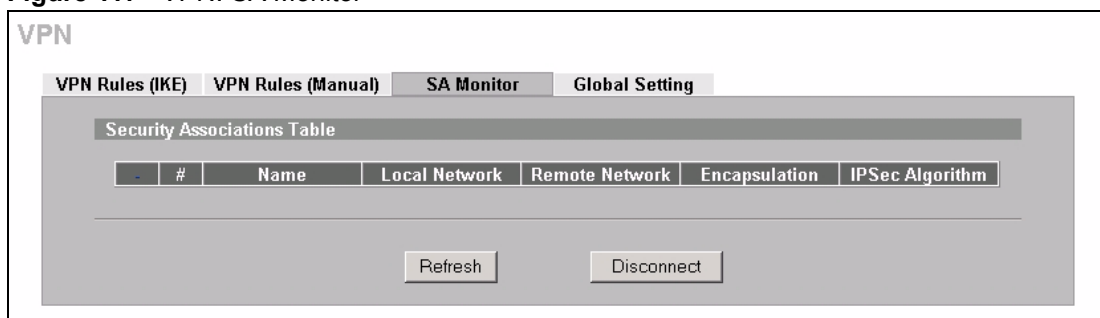
Figure 117 VPN: SA Monitor

The following table describes the labels in this screen.

Table 79 VPN: SA Monitor

LABEL	DESCRIPTION
#	This is the security association index number.
Name	This field displays the identification name for this VPN policy.
Local Network	This field displays the IP address of the computer using the VPN IPsec feature of your ZyWALL.
Remote Network	This field displays IP address (in a range) of computers on the remote network behind the remote IPsec router.
Encapsulation	This field displays Tunnel or Transport mode.
IPSec Algorithm	This field displays the security protocols used for an SA. Both AH and ESP increase ZyWALL processing requirements and communications latency (delay).
Refresh	Click Refresh to display the current active VPN connection(s).
Disconnect	Select a security association index number that you want to disconnect and then click Disconnect .

14.15 Configuring Global Setting

To change your ZyWALL's global settings, click **VPN**, then the **Global Setting** tab. The screen appears as shown.

Figure 118 VPN: Global Setting

The following table describes the labels in this screen.

Table 80 VPN: Global Setting

LABEL	DESCRIPTION
Output Idle Timer	When traffic is sent to a remote IPSec router from which no reply is received after the specified time period, the ZyWALL checks the VPN connectivity. If the remote IPSec router does not reply, the ZyWALL automatically disconnects the VPN tunnel. Enter the time period (between 30 and 3600 seconds) to wait before the ZyWALL checks all of the VPN connections to remote IPSec routers. Enter 0 to disable this feature.
Input Idle Timer	When no traffic is received from a remote IPSec router after the specified time period, the ZyWALL checks the VPN connectivity. If the remote IPSec router does not reply, the ZyWALL automatically disconnects the VPN tunnel. Enter the time period (between 30 and 3600 seconds) to wait before the ZyWALL checks all of the VPN connections to remote IPSec routers. Enter 0 to disable this feature.
Gateway Domain Name Update Timer	This field is applicable when you enter a domain name to identify the ZyWALL and/or the remote secure gateway. Enter the time period (between 2 and 60 minutes) to wait before the ZyWALL updates the domain name and IP address mapping through a DNS server. The ZyWALL rebuilds the VPN tunnel if it finds that the domain name is now using a different IP address (any users of the VPN tunnel will be temporarily disconnected). Enter 0 to disable this feature.
Apply	Click Apply to save your changes back to the ZyWALL.
Reset	Click Reset to begin configuring this screen afresh.

14.16 Telecommuter VPN/IPSec Examples

The following examples show how multiple telecommuters can make VPN connections to a single ZyWALL at headquarters. The telecommuters use IPSec routers with dynamic WAN IP addresses. The ZyWALL at headquarters has a static public IP address.

14.16.1 Telecommuters Sharing One VPN Rule Example

See the following figure and table for an example configuration that allows multiple telecommuters (A, B and C in the figure) to use one VPN rule to simultaneously access a ZyWALL at headquarters (HQ in the figure). The telecommuters do not have domain names mapped to the WAN IP addresses of their IPSec routers. The telecommuters must all use the same IPSec parameters but the local IP addresses (or ranges of addresses) should not overlap.

Figure 119 Telecommuters Sharing One VPN Rule Example

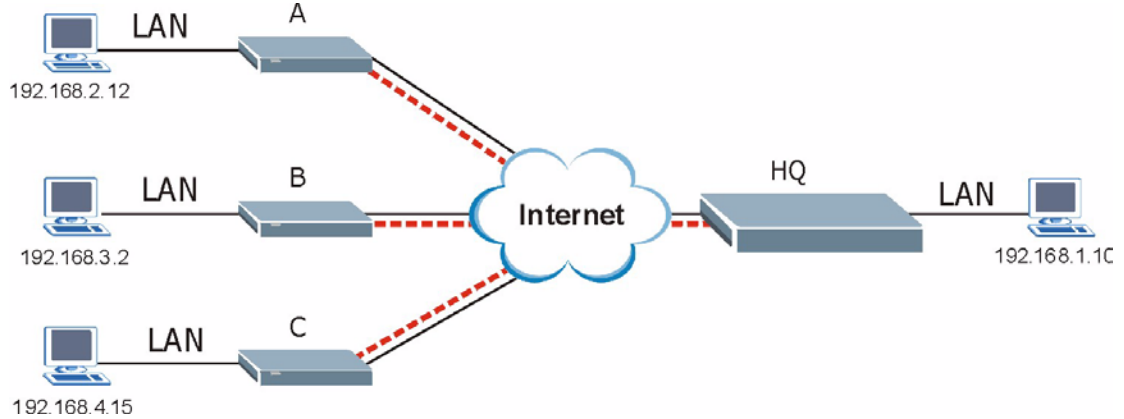

Table 81 Telecommuters Sharing One VPN Rule Example

FIELDS	TELECOMMUTERS	HEADQUARTERS
My ZyWALL:	0.0.0.0 (dynamic IP address assigned by the ISP)	Public static IP address
Remote Gateway Address:	Public static IP address	0.0.0.0 With this IP address only the telecommuter can initiate the IPSec tunnel.
Local Network - Single IP Address:	Telecommuter A: 192.168.2.12 Telecommuter B: 192.168.3.2 Telecommuter C: 192.168.4.15	192.168.1.10
Remote Network - Single IP Address:	192.168.1.10	Not Applicable

14.16.2 Telecommuters Using Unique VPN Rules Example

In this example the telecommuters (A, B and C in the figure) use IPSec routers with domain names that are mapped to their dynamic WAN IP addresses (use Dynamic DNS to do this).

With aggressive negotiation mode (see [Section 14.8.1 on page 241](#)), the ZyWALL can use the ID types and contents to distinguish between VPN rules. Telecommuters can each use a separate VPN rule to simultaneously access a ZyWALL at headquarters. They can use different IPSec parameters. The local IP addresses (or ranges of addresses) of the rules configured on the ZyWALL at headquarters can overlap. The local IP addresses of the rules configured on the telecommuters' IPSec routers should not overlap.

See the following table and figure for an example where three telecommuters each use a different VPN rule for a VPN connection with a ZyWALL located at headquarters. The ZyWALL at headquarters (HQ in the figure) identifies each incoming SA by its ID type and content and uses the appropriate VPN rule to establish the VPN connection.

The ZyWALL at headquarters can also initiate VPN connections to the telecommuters since it can find the telecommuters by resolving their domain names.

Figure 120 Telecommuters Using Unique VPN Rules Example

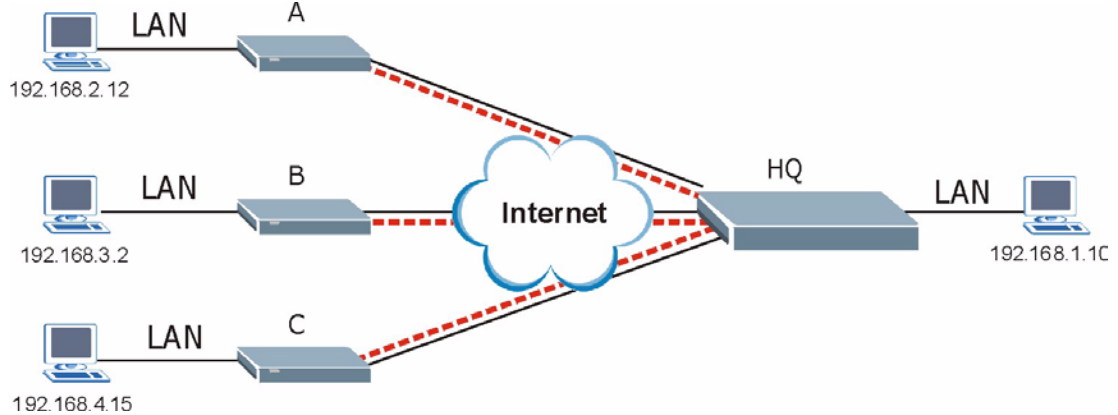

Table 82 Telecommuters Using Unique VPN Rules Example

TELECOMMUTERS	HEADQUARTERS
All Telecommuter Rules:	All Headquarters Rules:
My ZyWALL 0.0.0.0	My ZyWALL: bigcompanyhq.com
Remote Gateway Address: bigcompanyhq.com	Local Network - Single IP Address: 192.168.1.10
Remote Network - Single IP Address: 192.168.1.10	Local ID Type: E-mail
Peer ID Type: E-mail	Local ID Content: bob@bigcompanyhq.com
Peer ID Content: bob@bigcompanyhq.com	
Telecommuter A (telecommutera.dydns.org)	Headquarters ZyWALL Rule 1:
Local ID Type: IP	Peer ID Type: IP
Local ID Content: 192.168.2.12	Peer ID Content: 192.168.2.12
Local IP Address: 192.168.2.12	Remote Gateway Address: telecommutera.dydns.org
	Remote Address 192.168.2.12

Table 82 Telecommuters Using Unique VPN Rules Example

TELECOMMUTERS	HEADQUARTERS
Telecommuter B (telecommuterb.dydns.org)	Headquarters [Product Name (short)] Rule 2:
Local ID Type: DNS	Peer ID Type: DNS
Local ID Content: telecommuterb.com	Peer ID Content: telecommuterb.com
Local IP Address: 192.168.3.2	Remote Gateway Address: telecommuterb.dydns.org
	Remote Address 192.168.3.2
Telecommuter C (telecommuterc.dydns.org)	Headquarters [Product Name (short)] Rule 3:
Local ID Type: E-mail	Peer ID Type: E-mail
Local ID Content: myVPN@myplace.com	Peer ID Content: myVPN@myplace.com
Local IP Address: 192.168.4.15	Remote Gateway Address: telecommuterc.dydns.org
	Remote Address 192.168.4.15

14.17 VPN and Remote Management

If a VPN tunnel uses Telnet, FTP, WWW, SNMP, DNS or ICMP, then you should configure remote management (**REMOTE MGMT**) to allow access for that service.

CHAPTER 15

Certificates

This chapter gives background information about public-key certificates and explains how to use them.

15.1 Certificates Overview

The ZyWALL can use certificates (also called digital IDs) to authenticate users. Certificates are based on public-private key pairs. A certificate contains the certificate owner's identity and public key. Certificates provide a way to exchange public keys for use in authentication.

A Certification Authority (CA) issues certificates and guarantees the identity of each certificate owner. There are commercial certification authorities like CyberTrust or VeriSign and government certification authorities. You can use the ZyWALL to generate certification requests that contain identifying information and public keys and then send the certification requests to a certification authority.

In public-key encryption and decryption, each host has two keys. One key is public and can be made openly available; the other key is private and must be kept secure. Public-key encryption in general works as follows.

- 1 Tim wants to send a private message to Jenny. Tim generates a public key pair. What is encrypted with one key can only be decrypted using the other.
- 2 Tim keeps the private key and makes the public key openly available.
- 3 Tim uses his private key to encrypt the message and sends it to Jenny.
- 4 Jenny receives the message and uses Tim's public key to decrypt it.
- 5 Additionally, Jenny uses her own private key to encrypt a message and Tim uses Jenny's public key to decrypt the message.

The ZyWALL uses certificates based on public-key cryptology to authenticate users attempting to establish a connection, not to encrypt the data that you send after establishing a connection. The method used to secure the data that you send through an established connection depends on the type of connection. For example, a VPN tunnel might use the triple DES encryption algorithm.

The certification authority uses its private key to sign certificates. Anyone can then use the certification authority's public key to verify the certificates.

A certification path is the hierarchy of certification authority certificates that validate a certificate. The ZyWALL does not trust a certificate if any certificate on its path has expired or been revoked.

Certification authorities maintain directory servers with databases of valid and revoked certificates. A directory of certificates that have been revoked before the scheduled expiration is called a CRL (Certificate Revocation List). The ZyWALL can check a peer's certificate against a directory server's list of revoked certificates. The framework of servers, software, procedures and policies that handles keys is called PKI (public-key infrastructure).

15.1.1 Advantages of Certificates

Certificates offer the following benefits.

- The ZyWALL only has to store the certificates of the certification authorities that you decide to trust, no matter how many devices you need to authenticate.
- Key distribution is simple and very secure since you can freely distribute public keys and you never need to transmit private keys.

15.2 Self-signed Certificates

Until public-key infrastructure becomes more mature, it may not be available in some areas. You can have the ZyWALL act as a certification authority and sign its own certificates.

15.3 Configuration Summary

This section summarizes how to manage certificates on the ZyWALL.

Figure 121 Certificate Configuration Overview

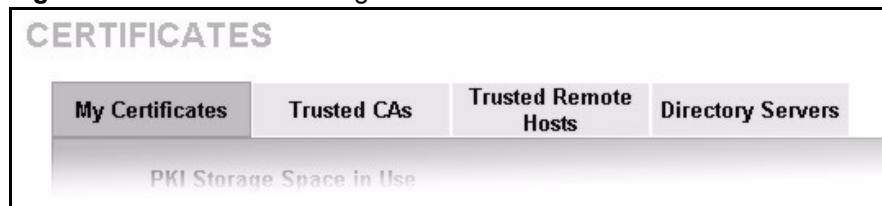

Use the **My Certificate** screens to generate and export self-signed certificates or certification requests and import the ZyWALL's CA-signed certificates.

Use the **Trusted CA** screens to save CA certificates to the ZyWALL.

Use the **Trusted Remote Hosts** screens to import self-signed certificates.

Use the **Directory Servers** screen to configure a list of addresses of directory servers (that contain lists of valid and revoked certificates).

15.4 My Certificates

Click **CERTIFICATES**, **My Certificates** to open the ZyWALL's summary list of certificates and certification requests. Certificates display in black and certification requests display in gray. See the following figure.

Figure 122 My Certificates

CERTIFICATES

My Certificates Trusted CAs Trusted Remote Hosts Directory Servers

PKI Storage Space in Use

0% 2% 100%

Replace Factory Default Certificate

Factory Default Certificate Name: auto_generated_self_signed_cert

The factory default certificate is common to all ZyWALL models. Click Replace to create a certificate using your ZyWALL's MAC address that will be specific to this device.

Replace

My Certificates

#	Name	Type	Subject	Issuer	Valid From	Valid To	Modify
1	auto_generated_self_signed_cert	*SELF	CN=ZyWALL 70 Factory Default Certificate	CN=ZyWALL 70 Factory Default Certificate	2000 Jan 1st, 00:00:00 GMT	2030 Jan 1st, 00:00:00 GMT	
2	Corey_ser	REQ	CN=172.1.2.3, O=ZyXEL, C=TW	N/A	N/A	N/A	
3	John_Smith	SELF	CN=johns@bigcompany.com, OU=Sales, O=Big Company, C=USA	CN=johns@bigcompany.com, OU=Sales, O=Big Company, C=USA	2004 Jun 28th, 02:09:06 GMT	2007 Jun 29th, 02:09:06 GMT	

Import Create Refresh

The following table describes the labels in this screen.

Table 83 My Certificates

LABEL	DESCRIPTION
PKI Storage Space in Use	This bar displays the percentage of the ZyWALL's PKI storage space that is currently in use. The bar turns from green to red when the maximum is being approached. When the bar is red, you should consider deleting expired or unnecessary certificates before adding more certificates.
Replace	This button displays when the ZyWALL has the factory default certificate. The factory default certificate is common to all ZyWALLs that use certificates. ZyXEL recommends that you use this button to replace the factory default certificate with one that uses your ZyWALL's MAC address.
#	This field displays the certificate index number. The certificates are listed in alphabetical order.
Name	This field displays the name used to identify this certificate. It is recommended that you give each certificate a unique name.

Table 83 My Certificates (continued)

LABEL	DESCRIPTION
Type	<p>This field displays what kind of certificate this is.</p> <p>REQ represents a certification request and is not yet a valid certificate. Send a certification request to a certification authority, which then issues a certificate. Use the My Certificate Import screen to import the certificate and replace the request.</p> <p>SELF represents a self-signed certificate.</p> <p>*SELF represents the default self-signed certificate, which the ZyWALL uses to sign imported trusted remote host certificates.</p> <p>CERT represents a certificate issued by a certification authority.</p>
Subject	<p>This field displays identifying information about the certificate's owner, such as CN (Common Name), OU (Organizational Unit or department), O (Organization or company) and C (Country). It is recommended that each certificate have unique subject information.</p>
Issuer	<p>This field displays identifying information about the certificate's issuing certification authority, such as a common name, organizational unit or department, organization or company and country. With self-signed certificates, this is the same information as in the Subject field.</p>
Valid From	<p>This field displays the date that the certificate becomes applicable. The text displays in red and includes a Not Yet Valid! message if the certificate has not yet become applicable.</p>
Valid To	<p>This field displays the date that the certificate expires. The text displays in red and includes an Expiring! or Expired! message if the certificate is about to expire or has already expired.</p>
Modify	<p>Click the details icon to open a screen with an in-depth list of information about the certificate.</p> <p>Click the delete icon to remove the certificate. A window displays asking you to confirm that you want to delete the certificate.</p> <p>You cannot delete a certificate that one or more features is configured to use.</p> <p>Do the following to delete a certificate that shows *SELF in the Type field.</p> <ol style="list-style-type: none"> 1. Make sure that no other features, such as HTTPS, VPN, SSH are configured to use the *SELF certificate. 2. Click the details icon next to another self-signed certificate (see the description on the Create button if you need to create a self-signed certificate). 3. Select the Default self-signed certificate which signs the imported remote host certificates check box. 4. Click Apply to save the changes and return to the My Certificates screen. 5. The certificate that originally showed *SELF displays SELF and you can delete it now. <p>Note that subsequent certificates move up by one when you take this action</p>
Import	<p>Click Import to open a screen where you can save the certificate that you have enrolled from a certification authority from your computer to the ZyWALL.</p>
Create	<p>Click Create to go to the screen where you can have the ZyWALL generate a certificate or a certification request.</p>
Refresh	<p>Click Refresh to display the current validity status of the certificates.</p>

15.5 Certificate File Formats

The certification authority certificate that you want to import has to be in one of these file formats:

- Binary X.509: This is an ITU-T recommendation that defines the formats for X.509 certificates.
- PEM (Base-64) encoded X.509: This Privacy Enhanced Mail format uses 64 ASCII characters to convert a binary X.509 certificate into a printable form.
- Binary PKCS#7: This is a standard that defines the general syntax for data (including digital signatures) that may be encrypted. The ZyWALL currently allows the importation of a PKCS#7 file that contains a single certificate.
- PEM (Base-64) encoded PKCS#7: This Privacy Enhanced Mail (PEM) format uses 64 ASCII characters to convert a binary PKCS#7 certificate into a printable form.

15.6 Importing a Certificate

Click **CERTIFICATES**, **My Certificates** and then **Import** to open the **My Certificate Import** screen. Follow the instructions in this screen to save an existing certificate to the ZyWALL, see the following figure.

Note: You can only import a certificate that matches a corresponding certification request that was generated by the ZyWALL.

The certificate you import replaces the corresponding request in the **My Certificates** screen.

You must remove any spaces from the certificate's filename before you can import it.

Figure 123 My Certificate Import

CERTIFICATES - MY CERTIFICATE - IMPORT

Import

Please specify the location of the certificate file to be imported. The certificate file must be in one of the following formats.

- Binary X.509
- PEM (Base-64) encoded X.509
- Binary PKCS#7
- PEM (Base-64) encoded PKCS#7

For my certificate importation to be successful, a certification request corresponding to the imported certificate must already exist on ZyWALL. After the importation, the certification request will automatically be deleted.

File Path:

The following table describes the labels in this screen.

Table 84 My Certificate Import

LABEL	DESCRIPTION
File Path	Type in the location of the file you want to upload in this field or click Browse to find it.
Browse	Click Browse to find the certificate file you want to upload.
Apply	Click Apply to save the certificate on the ZyWALL.
Cancel	Click Cancel to quit and return to the My Certificates screen.

15.7 Creating a Certificate

Click **CERTIFICATES**, **My Certificates** and then **Create** to open the **My Certificate Create** screen. Use this screen to have the ZyWALL create a self-signed certificate, enroll a certificate with a certification authority or generate a certification request, see the following figure.

Figure 124 My Certificate Create

CERTIFICATES - MY CERTIFICATE - CREATE

Certificate Name

Subject Information

Common Name

Host IP Address

Host Domain Name

E-Mail

Organizational Unit

Organization

Country

Key Length bits

Enrollment Options

Create a self-signed certificate

Create a certification request and save it locally for later manual enrollment

Create a certification request and enroll for a certificate immediately online

Enrollment Protocol

CA Server Address

CA Certificate (See [Trusted CAs](#))

Request Authentication

Key

The following table describes the labels in this screen.

Table 85 My Certificate Create

LABEL	DESCRIPTION
Certificate Name	Type up to 31 ASCII characters (not including spaces) to identify this certificate.
Subject Information	Use these fields to record information that identifies the owner of the certificate. You do not have to fill in every field, although the Common Name is mandatory. The certification authority may add fields (such as a serial number) to the subject information when it issues a certificate. It is recommended that each certificate have unique subject information.
Common Name	Select a radio button to identify the certificate's owner by IP address, domain name or e-mail address. Type the IP address (in dotted decimal notation), domain name or e-mail address in the field provided. The domain name or e-mail address can be up to 31 ASCII characters. The domain name or e-mail address is for identification purposes only and can be any string.
Organizational Unit	Type up to 127 characters to identify the organizational unit or department to which the certificate owner belongs. You may use any character, including spaces, but the ZyWALL drops trailing spaces.
Organization	Type up to 127 characters to identify the company or group to which the certificate owner belongs. You may use any character, including spaces, but the ZyWALL drops trailing spaces.
Country	Type up to 127 characters to identify the nation where the certificate owner is located. You may use any character, including spaces, but the ZyWALL drops trailing spaces.
Key Length	Select a number from the drop-down list box to determine how many bits the key should use (512 to 2048). The longer the key, the more secure it is. A longer key also uses more PKI storage space.
Enrollment Options	These radio buttons deal with how and when the certificate is to be generated.
Create a self-signed certificate	Select Create a self-signed certificate to have the ZyWALL generate the certificate and act as the Certification Authority (CA) itself. This way you do not need to apply to a certification authority for certificates.
Create a certification request and save it locally for later manual enrollment	Select Create a certification request and save it locally for later manual enrollment to have the ZyWALL generate and store a request for a certificate. Use the My Certificate Details screen to view the certification request and copy it to send to the certification authority. Copy the certification request from the My Certificate Details screen (see Section 15.8 on page 274) and then send it to the certification authority.
Create a certification request and enroll for a certificate immediately online	Select Create a certification request and enroll for a certificate immediately online to have the ZyWALL generate a request for a certificate and apply to a certification authority for a certificate. You must have the certification authority's certificate already imported in the Trusted CAs screen. When you select this option, you must select the certification authority's enrollment protocol and the certification authority's certificate from the drop-down list boxes and enter the certification authority's server address. You also need to fill in the Reference Number and Key if the certification authority requires them.

Table 85 My Certificate Create (continued)

LABEL	DESCRIPTION
Enrollment Protocol	Select the certification authority's enrollment protocol from the drop-down list box. Simple Certificate Enrollment Protocol (SCEP) is a TCP-based enrollment protocol that was developed by VeriSign and Cisco. Certificate Management Protocol (CMP) is a TCP-based enrollment protocol that was developed by the Public Key Infrastructure X.509 working group of the Internet Engineering Task Force (IETF) and is specified in RFC 2510.
CA Server Address	Enter the IP address (or URL) of the certification authority server.
CA Certificate	Select the certification authority's certificate from the CA Certificate drop-down list box. You must have the certification authority's certificate already imported in the Trusted CAs screen. Click Trusted CAs to go to the Trusted CAs screen where you can view (and manage) the ZyWALL's list of certificates of trusted certification authorities.
Request Authentication	When you select Create a certification request and enroll for a certificate immediately online , the certification authority may want you to include a reference number and key to identify you when you send a certification request. Fill in both the Reference Number and the Key fields if your certification authority uses CMP enrollment protocol. Just fill in the Key field if your certification authority uses the SCEP enrollment protocol.
Key	Type the key that the certification authority gave you.
Apply	Click Apply to begin certificate or certification request generation.
Cancel	Click Cancel to quit and return to the My Certificates screen.

After you click **Apply** in the **My Certificate Create** screen, you see a screen that tells you the ZyWALL is generating the self-signed certificate or certification request.

After the ZyWALL successfully enrolls a certificate or generates a certification request or a self-signed certificate, you see a screen with a **Return** button that takes you back to the **My Certificates** screen.

If you configured the **My Certificate Create** screen to have the ZyWALL enroll a certificate and the certificate enrollment is not successful, you see a screen with a **Return** button that takes you back to the **My Certificate Create** screen. Click **Return** and check your information in the **My Certificate Create** screen. Make sure that the certification authority information is correct and that your Internet connection is working properly if you want the ZyWALL to enroll a certificate online.

15.8 My Certificate Details

Click **CERTIFICATES**, and then **My Certificates** to open the **My Certificates** screen (see [Figure 122 on page 269](#)). Click the details icon to open the **My Certificate Details** screen. You can use this screen to view in-depth certificate information and change the certificate's name. In the case of a self-signed certificate, you can set it to be the one that the ZyWALL uses to sign the trusted remote host certificates that you import to the ZyWALL.

Table 86 My Certificate Details

LABEL	DESCRIPTION
Name	This field displays the identifying name of this certificate. If you want to change the name, type up to 31 characters to identify this certificate. You may use any character (not including spaces).
Property Default self-signed certificate which signs the imported remote host certificates.	Select this check box to have the ZyWALL use this certificate to sign the trusted remote host certificates that you import to the ZyWALL. This check box is only available with self-signed certificates. If this check box is already selected, you cannot clear it in this screen, you must select this check box in another self-signed certificate's details screen. This automatically clears the check box in the details screen of the certificate that was previously set to sign the imported trusted remote host certificates.
Certification Path	Click the Refresh button to have this read-only text box display the hierarchy of certification authorities that validate the certificate (and the certificate itself). If the issuing certification authority is one that you have imported as a trusted certification authority, it may be the only certification authority in the list (along with the certificate itself). If the certificate is a self-signed certificate, the certificate itself is the only one in the list. The ZyWALL does not trust the certificate and displays "Not trusted" in this field if any certificate on the path has expired or been revoked.
Refresh	Click Refresh to display the certification path.
Certificate Information	These read-only fields display detailed information about the certificate.
Type	This field displays general information about the certificate. CA-signed means that a Certification Authority signed the certificate. Self-signed means that the certificate's owner signed the certificate (not a certification authority). "X.509" means that this certificate was created and signed according to the ITU-T X.509 recommendation that defines the formats for public-key certificates.
Version	This field displays the X.509 version number.
Serial Number	This field displays the certificate's identification number given by the certification authority or generated by the ZyWALL.
Subject	This field displays information that identifies the owner of the certificate, such as Common Name (CN), Organizational Unit (OU), Organization (O) and Country (C).
Issuer	This field displays identifying information about the certificate's issuing certification authority, such as Common Name, Organizational Unit, Organization and Country. With self-signed certificates, this is the same as the Subject Name field.
Signature Algorithm	This field displays the type of algorithm that was used to sign the certificate. The ZyWALL uses rsa-pkcs1-sha1 (RSA public-private key encryption algorithm and the SHA1 hash algorithm). Some certification authorities may use rsa-pkcs1-md5 (RSA public-private key encryption algorithm and the MD5 hash algorithm).
Valid From	This field displays the date that the certificate becomes applicable. The text displays in red and includes a Not Yet Valid! message if the certificate has not yet become applicable.
Valid To	This field displays the date that the certificate expires. The text displays in red and includes an Expiring! or Expired! message if the certificate is about to expire or has already expired.
Key Algorithm	This field displays the type of algorithm that was used to generate the certificate's key pair (the ZyWALL uses RSA encryption) and the length of the key set in bits (1024 bits for example).

Table 86 My Certificate Details (continued)

LABEL	DESCRIPTION
Subject Alternative Name	This field displays the certificate owner's IP address (IP), domain name (DNS) or e-mail address (EMAIL).
Key Usage	This field displays for what functions the certificate's key can be used. For example, "DigitalSignature" means that the key can be used to sign certificates and "KeyEncipherment" means that the key can be used to encrypt text.
Basic Constraint	This field displays general information about the certificate. For example, Subject Type=CA means that this is a certification authority's certificate and "Path Length Constraint=1" means that there can only be one certification authority in the certificate's path.
MD5 Fingerprint	This is the certificate's message digest that the ZyWALL calculated using the MD5 algorithm.
SHA1 Fingerprint	This is the certificate's message digest that the ZyWALL calculated using the SHA1 algorithm.
Certificate in PEM (Base-64) Encoded Format	<p>This read-only text box displays the certificate or certification request in Privacy Enhanced Mail (PEM) format. PEM uses 64 ASCII characters to convert the binary certificate into a printable form.</p> <p>You can copy and paste a certification request into a certification authority's web page, an e-mail that you send to the certification authority or a text editor and save the file on a management computer for later manual enrollment.</p> <p>You can copy and paste a certificate into an e-mail to send to friends or colleagues or you can copy and paste a certificate into a text editor and save the file on a management computer for later distribution (via floppy disk for example).</p>
Export	Click this button and then Save in the File Download screen. The Save As screen opens, browse to the location that you want to use and click Save .
Apply	Click Apply to save your changes back to the ZyWALL. You can only change the name, except in the case of a self-signed certificate, which you can also set to be the default self-signed certificate that signs the imported trusted remote host certificates.
Cancel	Click Cancel to quit and return to the My Certificates screen.

15.9 Trusted CAs

Click **CERTIFICATES, Trusted CAs** to open the **Trusted CAs** screen. This screen displays a summary list of certificates of the certification authorities that you have set the ZyWALL to accept as trusted. The ZyWALL accepts any valid certificate signed by a certification authority on this list as being trustworthy; thus you do not need to import any certificate that is signed by one of these certification authorities. See the following figure.

Figure 126 Trusted CAs

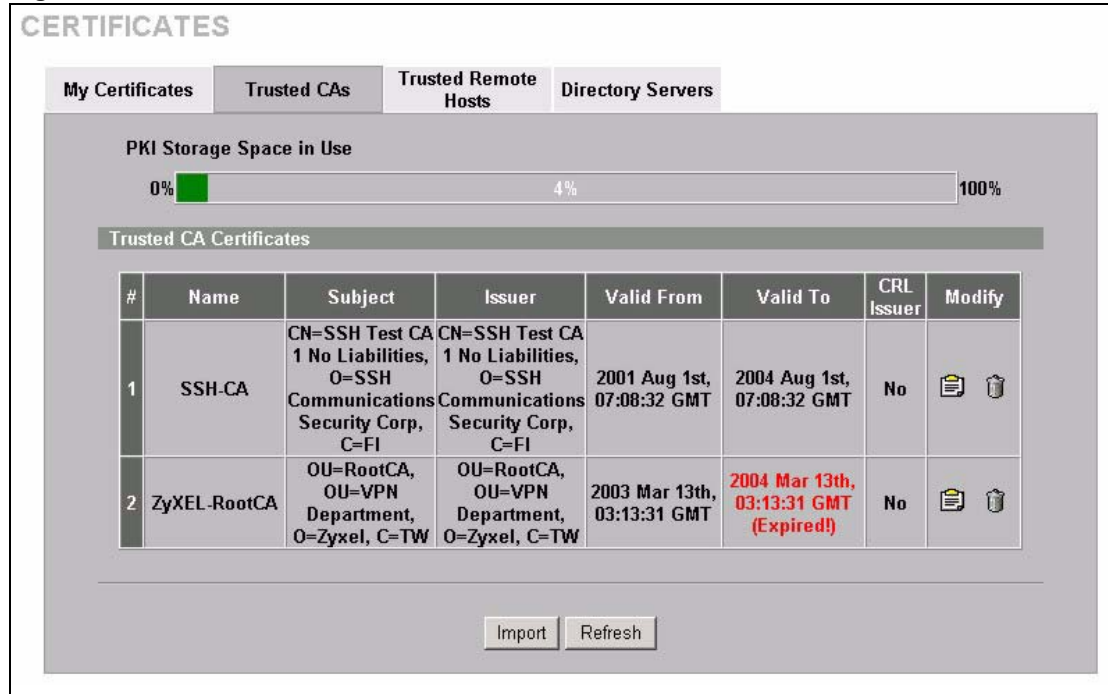

The following table describes the labels in this screen.

Table 87 Trusted CAs

LABEL	DESCRIPTION
PKI Storage Space in Use	This bar displays the percentage of the ZyWALL's PKI storage space that is currently in use. The bar turns from green to red when the maximum is being approached. When the bar is red, you should consider deleting expired or unnecessary certificates before adding more certificates.
#	This field displays the certificate index number. The certificates are listed in alphabetical order.
Name	This field displays the name used to identify this certificate.
Subject	This field displays identifying information about the certificate's owner, such as CN (Common Name), OU (Organizational Unit or department), O (Organization or company) and C (Country). It is recommended that each certificate have unique subject information.
Issuer	This field displays identifying information about the certificate's issuing certification authority, such as a common name, organizational unit or department, organization or company and country. With self-signed certificates, this is the same information as in the Subject field.
Valid From	This field displays the date that the certificate becomes applicable. The text displays in red and includes a Not Yet Valid! message if the certificate has not yet become applicable.
Valid To	This field displays the date that the certificate expires. The text displays in red and includes an Expiring! or Expired! message if the certificate is about to expire or has already expired.

Table 87 Trusted CAs (continued)

LABEL	DESCRIPTION
CRL Issuer	This field displays Yes if the certification authority issues Certificate Revocation Lists for the certificates that it has issued and you have selected the Issues certificate revocation lists (CRL) check box in the certificate's details screen to have the ZyWALL check the CRL before trusting any certificates issued by the certification authority. Otherwise the field displays "No".
Modify	Click the details icon to open a screen with an in-depth list of information about the certificate. Click the delete icon to remove the certificate. A window displays asking you to confirm that you want to delete the certificates. Note that subsequent certificates move up by one when you take this action.
Import	Click Import to open a screen where you can save the certificate of a certification authority that you trust, from your computer to the ZyWALL.
Refresh	Click this button to display the current validity status of the certificates.

15.10 Importing a Trusted CA's Certificate

Click **CERTIFICATES, Trusted CAs** to open the **Trusted CAs** screen and then click **Import** to open the **Trusted CA Import** screen. Follow the instructions in this screen to save a trusted certification authority's certificate to the ZyWALL, see the following figure.

Note: You must remove any spaces from the certificate's filename before you can import the certificate.

Figure 127 Trusted CA Import

CERTIFICATES - TRUSTED CA - IMPORT

Import

Please specify the location of the certificate file to be imported. The certificate file must be in one of the following formats.

- Binary X.509
- PEM (Base-64) encoded X.509
- Binary PKCS#7
- PEM (Base-64) encoded PKCS#7

File Path:

The following table describes the labels in this screen.

Table 88 Trusted CA Import

LABEL	DESCRIPTION
File Path	Type in the location of the file you want to upload in this field or click Browse to find it.
Browse	Click Browse to find the certificate file you want to upload.
Apply	Click Apply to save the certificate on the ZyWALL.
Cancel	Click Cancel to quit and return to the Trusted CAs screen.

15.11 Trusted CA Certificate Details

Click **CERTIFICATES, Trusted CAs** to open the **Trusted CAs** screen. Click the details icon to open the **Trusted CA Details** screen. Use this screen to view in-depth information about the certification authority's certificate, change the certificate's name and set whether or not you want the ZyWALL to check a certification authority's list of revoked certificates before trusting a certificate issued by the certification authority.

Figure 128 Trusted CA Details

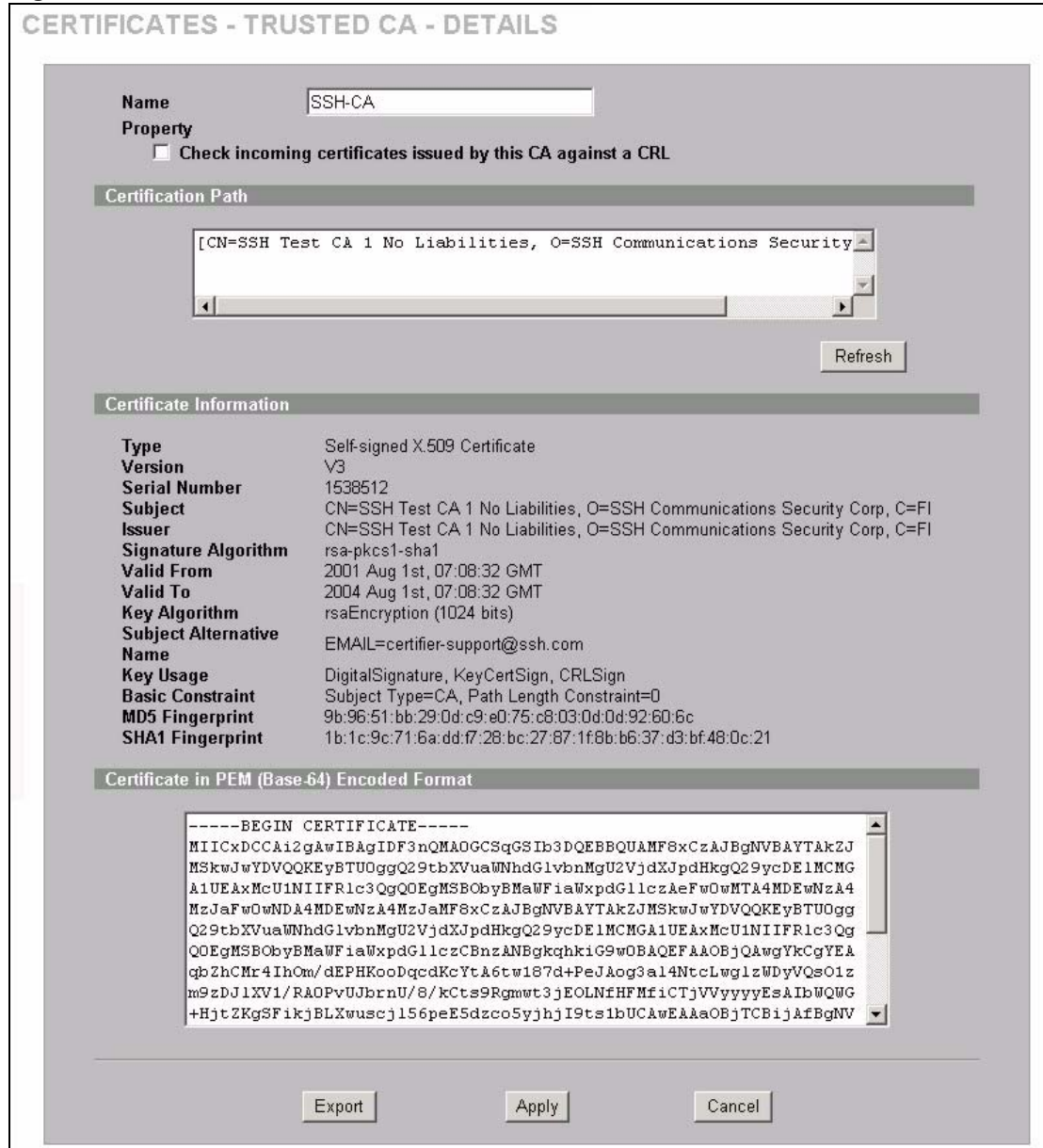

The following table describes the labels in this screen.

Table 89 Trusted CA Details

LABEL	DESCRIPTION
Name	This field displays the identifying name of this certificate. If you want to change the name, type up to 31 characters to identify this key certificate. You may use any character (not including spaces).
Property Check incoming certificates issued by this CA against a CRL	Select this check box to have the ZyWALL check incoming certificates that are issued by this certification authority against a Certificate Revocation List (CRL). Clear this check box to have the ZyWALL not check incoming certificates that are issued by this certification authority against a Certificate Revocation List (CRL).

Table 89 Trusted CA Details (continued)

LABEL	DESCRIPTION
Certification Path	Click the Refresh button to have this read-only text box display the end entity's certificate and a list of certification authority certificates that shows the hierarchy of certification authorities that validate the end entity's certificate. If the issuing certification authority is one that you have imported as a trusted certification authority, it may be the only certification authority in the list (along with the end entity's own certificate). The ZyWALL does not trust the end entity's certificate and displays "Not trusted" in this field if any certificate on the path has expired or been revoked.
Refresh	Click Refresh to display the certification path.
Certificate Information	These read-only fields display detailed information about the certificate.
Type	This field displays general information about the certificate. CA-signed means that a Certification Authority signed the certificate. Self-signed means that the certificate's owner signed the certificate (not a certification authority). X.509 means that this certificate was created and signed according to the ITU-T X.509 recommendation that defines the formats for public-key certificates.
Version	This field displays the X.509 version number.
Serial Number	This field displays the certificate's identification number given by the certification authority.
Subject	This field displays information that identifies the owner of the certificate, such as Common Name (CN), Organizational Unit (OU), Organization (O) and Country (C).
Issuer	This field displays identifying information about the certificate's issuing certification authority, such as Common Name, Organizational Unit, Organization and Country. With self-signed certificates, this is the same information as in the Subject Name field.
Signature Algorithm	This field displays the type of algorithm that was used to sign the certificate. Some certification authorities use rsa-pkcs1-sha1 (RSA public-private key encryption algorithm and the SHA1 hash algorithm). Other certification authorities may use rsa-pkcs1-md5 (RSA public-private key encryption algorithm and the MD5 hash algorithm).
Valid From	This field displays the date that the certificate becomes applicable. The text displays in red and includes a Not Yet Valid! message if the certificate has not yet become applicable.
Valid To	This field displays the date that the certificate expires. The text displays in red and includes an Expiring! or Expired! message if the certificate is about to expire or has already expired.
Key Algorithm	This field displays the type of algorithm that was used to generate the certificate's key pair (the ZyWALL uses RSA encryption) and the length of the key set in bits (1024 bits for example).
Subject Alternative Name	This field displays the certificate's owner's IP address (IP), domain name (DNS) or e-mail address (EMAIL).
Key Usage	This field displays for what functions the certificate's key can be used. For example, "DigitalSignature" means that the key can be used to sign certificates and "KeyEncipherment" means that the key can be used to encrypt text.
Basic Constraint	This field displays general information about the certificate. For example, Subject Type=CA means that this is a certification authority's certificate and "Path Length Constraint=1" means that there can only be one certification authority in the certificate's path.

Table 89 Trusted CA Details (continued)

LABEL	DESCRIPTION
CRL Distribution Points	This field displays how many directory servers with Lists of revoked certificates the issuing certification authority of this certificate makes available. This field also displays the domain names or IP addresses of the servers.
MD5 Fingerprint	This is the certificate's message digest that the ZyWALL calculated using the MD5 algorithm. You can use this value to verify with the certification authority (over the phone for example) that this is actually their certificate.
SHA1 Fingerprint	This is the certificate's message digest that the ZyWALL calculated using the SHA1 algorithm. You can use this value to verify with the certification authority (over the phone for example) that this is actually their certificate.
Certificate in PEM (Base-64) Encoded Format	This read-only text box displays the certificate or certification request in Privacy Enhanced Mail (PEM) format. PEM uses 64 ASCII characters to convert the binary certificate into a printable form. You can copy and paste the certificate into an e-mail to send to friends or colleagues or you can copy and paste the certificate into a text editor and save the file on a management computer for later distribution (via floppy disk for example).
Export	Click this button and then Save in the File Download screen. The Save As screen opens, browse to the location that you want to use and click Save .
Apply	Click Apply to save your changes back to the ZyWALL. You can only change the name and/or set whether or not you want the ZyWALL to check the CRL that the certification authority issues before trusting a certificate issued by the certification authority.
Cancel	Click Cancel to quit and return to the Trusted CAs screen.

15.12 Trusted Remote Hosts

Click **CERTIFICATES**, **Trusted Remote Hosts** to open the **Trusted Remote Hosts** screen (see the following figure). This screen displays a list of the certificates of peers that you trust but which are not signed by one of the certification authorities on the **Trusted CAs** screen.

You do not need to add any certificate that is signed by one of the certification authorities on the **Trusted CAs** screen since the ZyWALL automatically accepts any valid certificate signed by a trusted certification authority as being trustworthy.

Figure 129 Trusted Remote Hosts

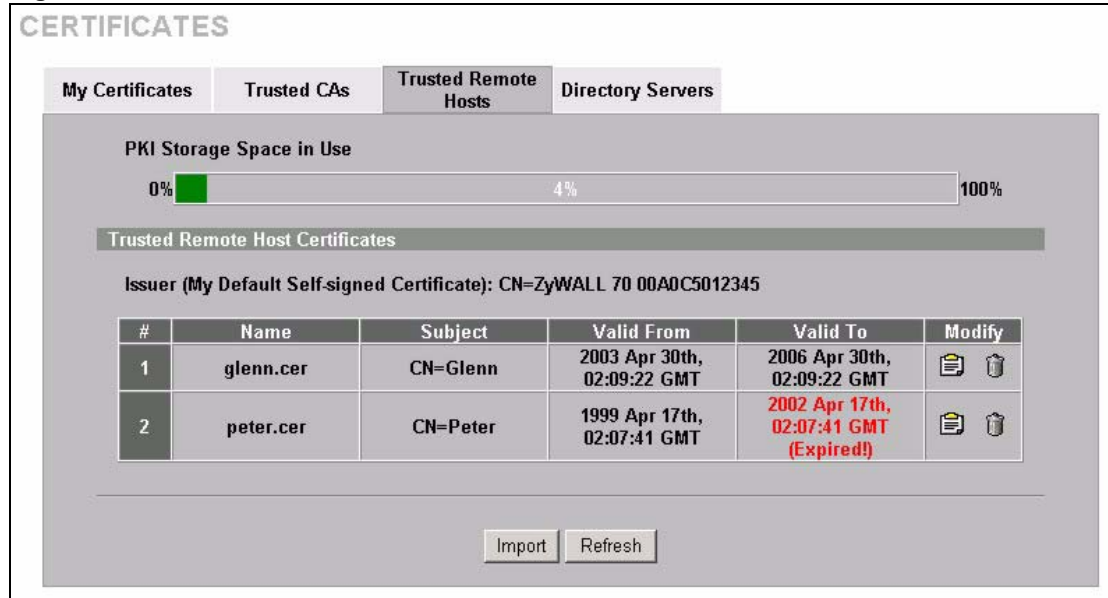

The following table describes the labels in this screen.

Table 90 Trusted Remote Hosts

LABEL	DESCRIPTION
PKI Storage Space in Use	This bar displays the percentage of the ZyWALL's PKI storage space that is currently in use. The bar turns from green to red when the maximum is being approached. When the bar is red, you should consider deleting expired or unnecessary certificates before adding more certificates.
Issuer (My Default Self-signed Certificate)	This field displays identifying information about the default self-signed certificate on the ZyWALL that the ZyWALL uses to sign the trusted remote host certificates.
#	This field displays the certificate index number. The certificates are listed in alphabetical order.
Name	This field displays the name used to identify this certificate.
Subject	This field displays identifying information about the certificate's owner, such as CN (Common Name), OU (Organizational Unit or department), O (Organization or company) and C (Country). It is recommended that each certificate have unique subject information.
Valid From	This field displays the date that the certificate becomes applicable. The text displays in red and includes a Not Yet Valid! message if the certificate has not yet become applicable.
Valid To	This field displays the date that the certificate expires. The text displays in red and includes an Expiring! or Expired! message if the certificate is about to expire or has already expired.
Modify	Click the details icon to open a screen with an in-depth list of information about the certificate. Click the delete icon to remove the certificate. A window displays asking you to confirm that you want to delete the certificate. Note that subsequent certificates move up by one when you take this action.

Table 90 Trusted Remote Hosts (continued)

LABEL	DESCRIPTION
Import	Click Import to open a screen where you can save the certificate of a remote host (which you trust) from your computer to the ZyWALL.
Refresh	Click this button to display the current validity status of the certificates.

15.13 Verifying a Trusted Remote Host's Certificate

Certificates issued by certification authorities have the certification authority's signature for you to check. Self-signed certificates only have the signature of the host itself. This means that you must be very careful when deciding to import (and thereby trust) a remote host's self-signed certificate.

15.13.1 Trusted Remote Host Certificate Fingerprints

A certificate's fingerprints are message digests calculated using the MD5 or SHA1 algorithms. The following procedure describes how to use a certificate's fingerprint to verify that you have the remote host's actual certificate.

- 1 Browse to where you have the remote host's certificate saved on your computer.
- 2 Make sure that the certificate has a ".cer" or ".crt" file name extension.

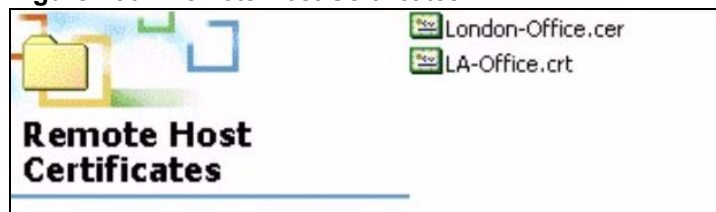
Figure 130 Remote Host Certificates

- 3 Double-click the certificate's icon to open the **Certificate** window. Click the **Details** tab and scroll down to the **Thumbprint Algorithm** and **Thumbprint** fields.

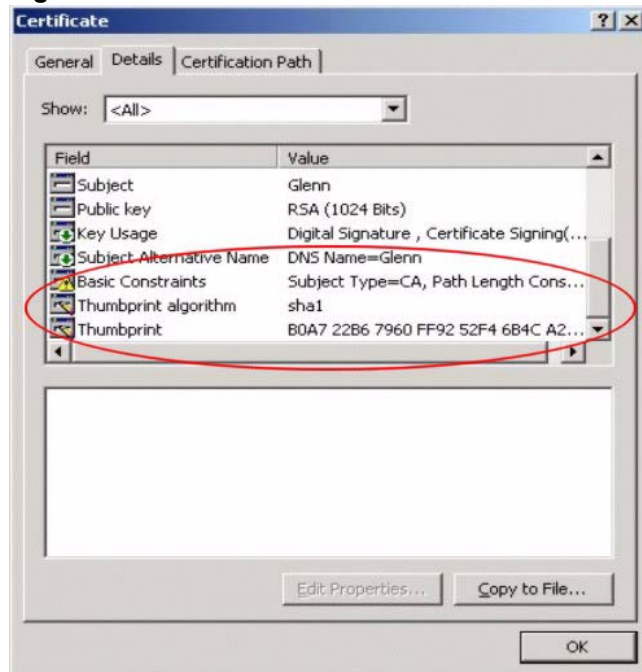
Figure 131 Certificate Details

Verify (over the phone for example) that the remote host has the same information in the **Thumbprint Algorithm** and **Thumbprint** fields.

15.14 Importing a Trusted Remote Host's Certificate

Click **CERTIFICATES**, **Trusted Remote Hosts** to open the **Trusted Remote Hosts** screen and then click **Import** to open the **Trusted Remote Host Import** screen. Follow the instructions in this screen to save a trusted host's certificate to the ZyWALL, see the following figure.

Note: The trusted remote host certificate must be a self-signed certificate; and you must remove any spaces from its filename before you can import it.

Figure 132 Trusted Remote Host Import

CERTIFICATES - TRUSTED REMOTE HOST - IMPORT

Import

Please specify the location of the certificate file to be imported. The certificate file must be in one of the following formats.

- Binary X.509
- PEM (Base-64) encoded X.509
- Binary PKCS#7
- PEM (Base-64) encoded PKCS#7

File Path:

The following table describes the labels in this screen.

Table 91 Trusted Remote Host Import

LABEL	DESCRIPTION
File Path	Type in the location of the file you want to upload in this field or click Browse to find it.
Browse	Click Browse to find the certificate file you want to upload.
Apply	Click Apply to save the certificate on the ZyWALL.
Cancel	Click Cancel to quit and return to the Trusted Remote Hosts screen.

15.15 Trusted Remote Host Certificate Details

Click **CERTIFICATES, Trusted Remote Hosts** to open the **Trusted Remote Hosts** screen. Click the details icon to open the **Trusted Remote Host Details** screen. You can use this screen to view in-depth information about the trusted remote host's certificate and/or change the certificate's name.

Figure 133 Trusted Remote Host Details

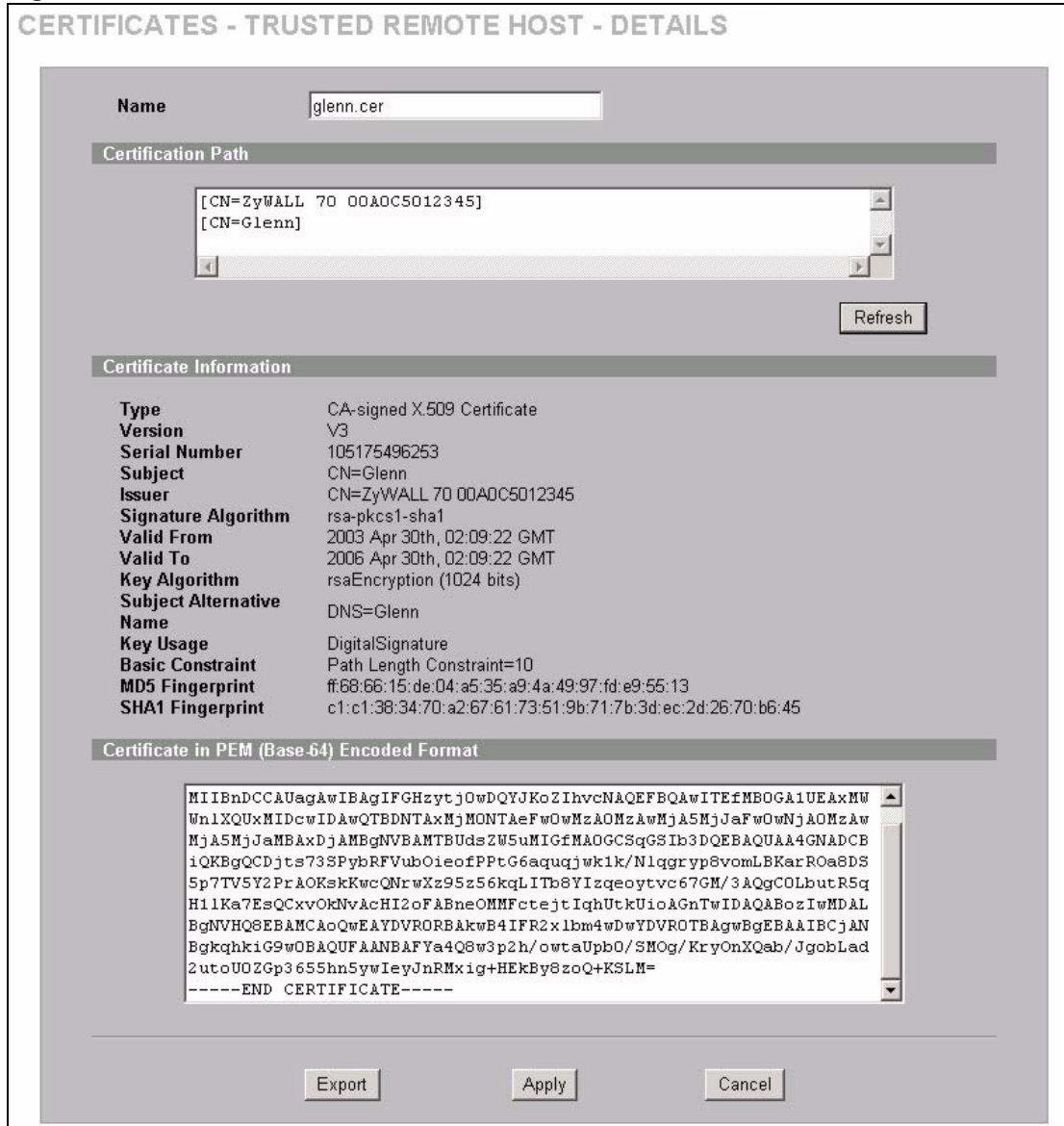

The following table describes the labels in this screen.

Table 92 Trusted Remote Host Details

LABEL	DESCRIPTION
Name	This field displays the identifying name of this certificate. If you want to change the name, type up to 31 characters to identify this key certificate. You may use any character (not including spaces).
Certification Path	Click the Refresh button to have this read-only text box display the end entity's own certificate and a list of certification authority certificates in the hierarchy of certification authorities that validate a certificate's issuing certification authority. For a trusted host, the list consists of the end entity's own certificate and the default self-signed certificate that the ZyWALL uses to sign remote host certificates.
Refresh	Click Refresh to display the certification path.

Table 92 Trusted Remote Host Details (continued)

LABEL	DESCRIPTION
Certificate Information	These read-only fields display detailed information about the certificate.
Type	This field displays general information about the certificate. With trusted remote host certificates, this field always displays CA-signed. The ZyWALL is the Certification Authority that signed the certificate. X.509 means that this certificate was created and signed according to the ITU-T X.509 recommendation that defines the formats for public-key certificates.
Version	This field displays the X.509 version number.
Serial Number	This field displays the certificate's identification number given by the device that created the certificate.
Subject	This field displays information that identifies the owner of the certificate, such as Common Name (CN), Organizational Unit (OU), Organization (O) and Country (C).
Issuer	This field displays identifying information about the default self-signed certificate on the ZyWALL that the ZyWALL uses to sign the trusted remote host certificates.
Signature Algorithm	This field displays the type of algorithm that the ZyWALL used to sign the certificate, which is rsa-pkcs1-sha1 (RSA public-private key encryption algorithm and the SHA1 hash algorithm).
Valid From	This field displays the date that the certificate becomes applicable. The text displays in red and includes a Not Yet Valid! message if the certificate has not yet become applicable.
Valid To	This field displays the date that the certificate expires. The text displays in red and includes an Expiring! or Expired! message if the certificate is about to expire or has already expired.
Key Algorithm	This field displays the type of algorithm that was used to generate the certificate's key pair (the ZyWALL uses RSA encryption) and the length of the key set in bits (1024 bits for example).
Subject Alternative Name	This field displays the certificate's owner's IP address (IP), domain name (DNS) or e-mail address (EMAIL).
Key Usage	This field displays for what functions the certificate's key can be used. For example, "DigitalSignature" means that the key can be used to sign certificates and "KeyEncipherment" means that the key can be used to encrypt text.
Basic Constraint	This field displays general information about the certificate. For example, Subject Type=CA means that this is a certification authority's certificate and "Path Length Constraint=1" means that there can only be one certification authority in the certificate's path.
MD5 Fingerprint	This is the certificate's message digest that the ZyWALL calculated using the MD5 algorithm. You cannot use this value to verify that this is the remote host's actual certificate because the ZyWALL has signed the certificate; thus causing this value to be different from that of the remote hosts actual certificate. See Section 15.13 on page 285 for how to verify a remote host's certificate.
SHA1 Fingerprint	This is the certificate's message digest that the ZyWALL calculated using the SHA1 algorithm. You cannot use this value to verify that this is the remote host's actual certificate because the ZyWALL has signed the certificate; thus causing this value to be different from that of the remote hosts actual certificate. See Section 15.13 on page 285 for how to verify a remote host's certificate.

Table 92 Trusted Remote Host Details (continued)

LABEL	DESCRIPTION
Certificate in PEM (Base-64) Encoded Format	This read-only text box displays the certificate or certification request in Privacy Enhanced Mail (PEM) format. PEM uses 64 ASCII characters to convert the binary certificate into a printable form. You can copy and paste the certificate into an e-mail to send to friends or colleagues or you can copy and paste the certificate into a text editor and save the file on a management computer for later distribution (via floppy disk for example).
Export	Click this button and then Save in the File Download screen. The Save As screen opens, browse to the location that you want to use and click Save .
Apply	Click Apply to save your changes back to the ZyWALL. You can only change the name of the certificate.
Cancel	Click Cancel to quit configuring this screen and return to the Trusted Remote Hosts screen.

15.16 Directory Servers

Click **CERTIFICATES**, **Directory Servers** to open the **Directory Servers** screen. This screen displays a summary list of directory servers (that contain lists of valid and revoked certificates) that have been saved into the ZyWALL. If you decide to have the ZyWALL check incoming certificates against the issuing certification authority's list of revoked certificates, the ZyWALL first checks the server(s) listed in the **CRL Distribution Points** field of the incoming certificate. If the certificate does not list a server or the listed server is not available, the ZyWALL checks the servers listed here.

Figure 134 Directory Servers

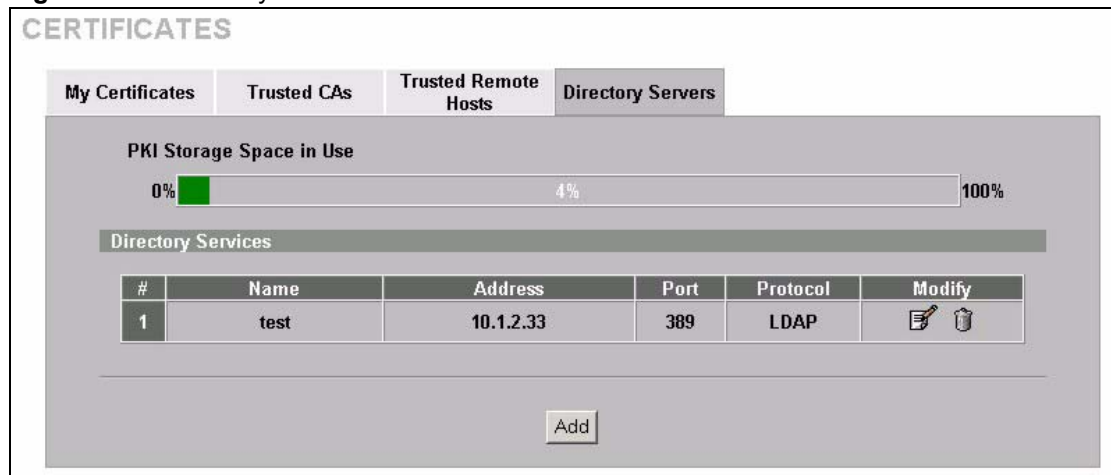

The following table describes the labels in this screen.

Table 93 Directory Servers

LABEL	DESCRIPTION
PKI Storage Space in Use	This bar displays the percentage of the ZyWALL's PKI storage space that is currently in use. The bar turns from green to red when the maximum is being approached. When the bar is red, you should consider deleting expired or unnecessary certificates before adding more certificates.
#	The index number of the directory server. The servers are listed in alphabetical order.
Name	This field displays the name used to identify this directory server.
Address	This field displays the IP address or domain name of the directory server.
Port	This field displays the port number that the directory server uses.
Protocol	This field displays the protocol that the directory server uses.
Modify	Click the details icon to open a screen where you can change the information about the directory server. Click the delete icon to remove the directory server entry. A window displays asking you to confirm that you want to delete the directory server. Note that subsequent certificates move up by one when you take this action.
Add	Click Add to open a screen where you can configure information about a directory server so that the ZyWALL can access it.

15.17 Add or Edit a Directory Server

Click **CERTIFICATES, Directory Servers** to open the **Directory Servers** screen. Click **Add** (or the details icon) to open the following screen. Use this screen to configure information about a directory server that the ZyWALL can access.

Figure 135 Directory Server Add

CERTIFICATES - DIRECTORY SERVER - ADD

Directory Service Setting

Name

Access Protocol

Server Address (Host Name or IP Address)

Server Port

Login Setting

Login

Password

The following table describes the labels in this screen.

Table 94 Directory Server Add

LABEL	DESCRIPTION
Directory Service Setting	
Name	Type up to 31 ASCII characters (spaces are not permitted) to identify this directory server.
Access Protocol	Use the drop-down list box to select the access protocol used by the directory server. LDAP (Lightweight Directory Access Protocol) is a protocol over TCP that specifies how clients access directories certificates and lists of revoked certificates. ^a
Server Address	Type the IP address (in dotted decimal notation) or the domain name of the directory server.
Server Port	This field displays the default server port number of the protocol that you select in the Access Protocol field. You may change the server port number if needed, however you must use the same server port number that the directory server uses. 389 is the default server port number for LDAP.
Login Setting	
Login	The ZyWALL may need to authenticate itself in order to assess the directory server. Type the login name (up to 31 ASCII characters) from the entity maintaining the directory server (usually a certification authority).
Password	Type the password (up to 31 ASCII characters) from the entity maintaining the directory server (usually a certification authority).
Apply	Click Apply to save your changes back to the ZyWALL.
Cancel	Click Cancel to quit configuring this screen and return to the Directory Servers screen.

- a. At the time of writing, LDAP is the only choice of directory server access protocol.

CHAPTER 16

Authentication Server

This chapter discusses how to configure the ZyWALL's authentication server feature.

16.1 Authentication Server Overview

A ZyWALL set to be a VPN extended authentication server can use either the local user database internal to the ZyWALL or an external RADIUS server for an unlimited number of users. The ZyWALL uses the same local user database for VPN extended authentication and wireless LAN security. See [Section 6.10 on page 114](#) for more information about RADIUS.

16.1.1 Local User Database

By storing user profiles locally on the ZyWALL, your ZyWALL is able to authenticate users without interacting with a network RADIUS server. However, there is a limit on the number of users you may authenticate in this way.

16.1.2 RADIUS

The ZyWALL can use an external RADIUS server to authenticate an unlimited number of users.

16.2 Configuring Local User Database

To change your ZyWALL's local user list, click **AUTH SERVER**. The **Local User Database** screen appears as shown.

Figure 136 Local User Database

AUTHENTICATION SERVER

Local User Database RADIUS

User Database

#	Active	User Name	Password
1	<input type="checkbox"/>		
2	<input type="checkbox"/>		
3	<input type="checkbox"/>		
4	<input type="checkbox"/>		
5	<input type="checkbox"/>		
6	<input type="checkbox"/>		
7	<input type="checkbox"/>		
8	<input type="checkbox"/>		
9	<input type="checkbox"/>		
10	<input type="checkbox"/>		
11	<input type="checkbox"/>		
12	<input type="checkbox"/>		
13	<input type="checkbox"/>		
14	<input type="checkbox"/>		
15	<input type="checkbox"/>		
16	<input type="checkbox"/>		
17	<input type="checkbox"/>		
18	<input type="checkbox"/>		
19	<input type="checkbox"/>		
20	<input type="checkbox"/>		
21	<input type="checkbox"/>		
22	<input type="checkbox"/>		
23	<input type="checkbox"/>		
24	<input type="checkbox"/>		
25	<input type="checkbox"/>		
26	<input type="checkbox"/>		
27	<input type="checkbox"/>		
28	<input type="checkbox"/>		
29	<input type="checkbox"/>		
30	<input type="checkbox"/>		
31	<input type="checkbox"/>		
32	<input type="checkbox"/>		

Apply Reset

The following table describes the labels in this screen.

Table 95 Local User Database

LABEL	DESCRIPTION
Active	Select this check box to enable the user profile.
User Name	Enter the user name of the user profile.
Password	Enter a password up to 31 characters long for this user profile.
Apply	Click Apply to save your changes back to the ZyWALL.
Reset	Click Reset to begin configuring this screen afresh.

16.3 Configuring RADIUS

Use RADIUS to authenticate users using an external server.

Click **AUTH SERVER**, then the **RADIUS** tab to open the following screen where you can set up your ZyWALL's RADIUS server settings.

Figure 137 RADIUS

Local User Database **RADIUS**

Authentication Server

Active

Server IP Address: 0.0.0.0

Port Number: 1812

Key: _____

Accounting Server

Active

Server IP Address: 0.0.0.0

Port Number: 1813

Key: _____

Apply Reset

The following table describes the labels in this screen.

Table 96 RADIUS

LABEL	DESCRIPTION
Authentication Server	
Active	Select the check box to enable user authentication through an external authentication server. Clear the check box to enable user authentication using the local user profile on the ZyWALL.
Server IP Address	Enter the IP address of the external authentication server in dotted decimal notation.
Port Number	The default port of the RADIUS server for authentication is 1812 . You need not change this value unless your network administrator instructs you to do so with additional information.
Key	Enter a password (up to 31 alphanumeric characters) as the key to be shared between the external authentication server and the ZyWALL. The key is not sent over the network. This key must be the same on the external authentication server and ZyWALL.
Accounting Server	
Active	Select the check box to enable user accounting through an external authentication server.
Server IP Address	Enter the IP address of the external accounting server in dotted decimal notation.
Port Number	The default port of the RADIUS server for accounting is 1813 . You need not change this value unless your network administrator instructs you to do so with additional information.
Key	Enter a password (up to 31 alphanumeric characters) as the key to be shared between the external accounting server and the ZyWALL. The key is not sent over the network. This key must be the same on the external accounting server and ZyWALL.
Apply	Click Apply to save your changes back to the ZyWALL.
Reset	Click Reset to begin configuring this screen afresh.

CHAPTER 17

Network Address Translation (NAT)

This chapter discusses how to configure NAT on the ZyWALL.

17.1 NAT Overview

NAT (Network Address Translation - NAT, RFC 1631) is the translation of the IP address of a host in a packet. For example, the source address of an outgoing packet, used within one network is changed to a different IP address known within another network.

17.1.1 NAT Definitions

Inside/outside denotes where a host is located relative to the ZyWALL. For example, the computers of your subscribers are the inside hosts, while the web servers on the Internet are the outside hosts.

Global/local denotes the IP address of a host in a packet as the packet traverses a router. For example, the local address refers to the IP address of a host when the packet is in the local network, while the global address refers to the IP address of the host when the same packet is traveling in the WAN side.

Note that inside/outside refers to the location of a host, while global/local refers to the IP address of a host used in a packet. Thus, an inside local address (ILA) is the IP address of an inside host in a packet when the packet is still in the local network, while an inside global address (IGA) is the IP address of the same inside host when the packet is on the WAN side. The following table summarizes this information.

Table 97 NAT Definitions

TERM	DESCRIPTION
Inside	This refers to the host on the LAN.
Outside	This refers to the host on the WAN.
Local	This refers to the packet address (source or destination) as the packet travels on the LAN.
Global	This refers to the packet address (source or destination) as the packet travels on the WAN.

Note: NAT never changes the IP address (either local or global) of an **outside** host.

17.1.2 What NAT Does

In the simplest form, NAT changes the source IP address in a packet received from a subscriber (the inside local address) to another (the inside global address) before forwarding the packet to the WAN side. When the response comes back, NAT translates the destination address (the inside global address) back to the inside local address before forwarding it to the original inside host. Note that the IP address (either local or global) of an outside host is never changed.

The global IP addresses for the inside hosts can be either static or dynamically assigned by the ISP. In addition, you can designate servers (for example a web server and a telnet server) on your local network and make them accessible to the outside world. Although you can make designated servers on the LAN accessible to the outside world, it is strongly recommended that you attach those servers to the DMZ port instead. If you do not define any servers (for Many-to-One and Many-to-Many Overload mapping), NAT offers the additional benefit of firewall protection. With no servers defined, your ZyWALL filters out all incoming inquiries, thus preventing intruders from probing your network. For more information on IP address translation, refer to *RFC 1631, The IP Network Address Translator (NAT)*.

17.1.3 How NAT Works

Each packet has two addresses – a source address and a destination address. For outgoing packets, the ILA (Inside Local Address) is the source address on the LAN, and the IGA (Inside Global Address) is the source address on the WAN. For incoming packets, the ILA is the destination address on the LAN, and the IGA is the destination address on the WAN. NAT maps private (local) IP addresses to globally unique ones required for communication with hosts on other networks. It replaces the original IP source address (and TCP or UDP source port numbers for Many-to-One and Many-to-Many Overload NAT mapping) in each packet and then forwards it to the Internet. The ZyWALL keeps track of the original addresses and port numbers so incoming reply packets can have their original values restored. The following figure illustrates this.

Figure 138 How NAT Works

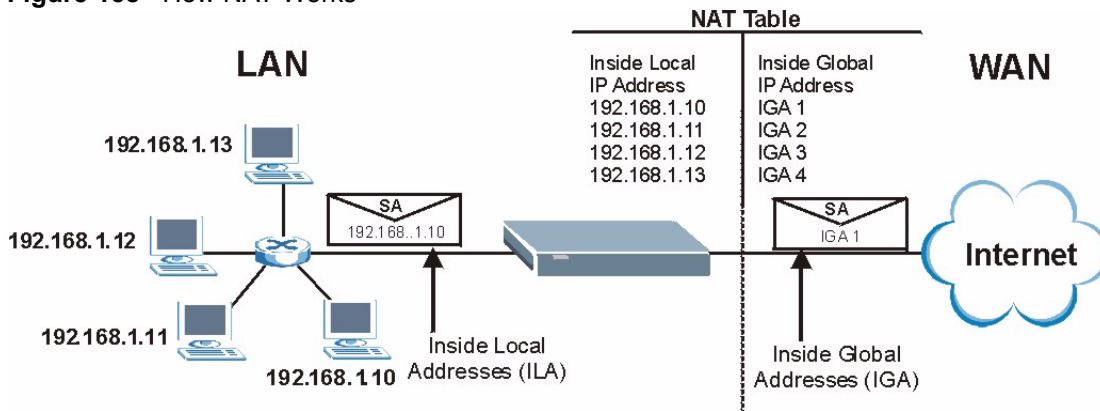

17.1.4 NAT Application

The following figure illustrates a possible NAT application, where three inside LANs (logical LANs using IP Alias) behind the ZyWALL can communicate with three distinct WAN networks. More examples follow at the end of this chapter.

Figure 139 NAT Application With IP Alias

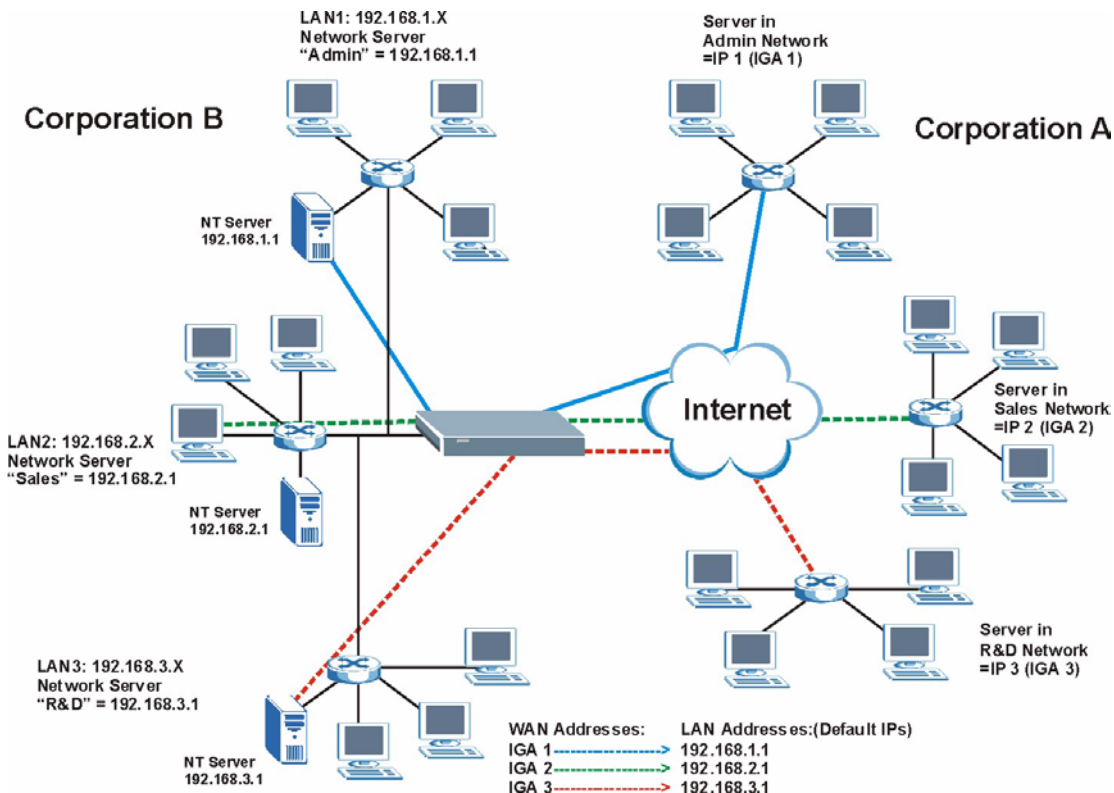

17.1.5 Port Restricted Cone NAT

Port restricted cone NAT maps all outgoing packets from an internal IP address and port to a single IP address and port on the external network. In the following example, the ZyWALL maps the source address of all packets sent from internal IP address **1** and port **A** to IP address **2** and port **B** on the external network. A host on the external network (IP address **3** and Port **C** for example) can only send packets to the internal host if the internal host has already sent a packet to the external host's IP address and port.

A server with IP address **1** and port **A** sends packets to IP address **3**, port **C** and IP address **4**, port **D**. The ZyWALL changes the server's IP address to **2** and port to **B**.

Since **1, A** has already sent packets to **3, C** and **4, D**, they can send packets back to **2, B** and the ZyWALL will perform NAT on them and send them to the server at IP address **1**, port **A**.

Packets have not been sent from **1, A** to **4, E** or **5**, so they cannot send packets to **1, A**.

Figure 140 Port Restricted Cone NAT Example

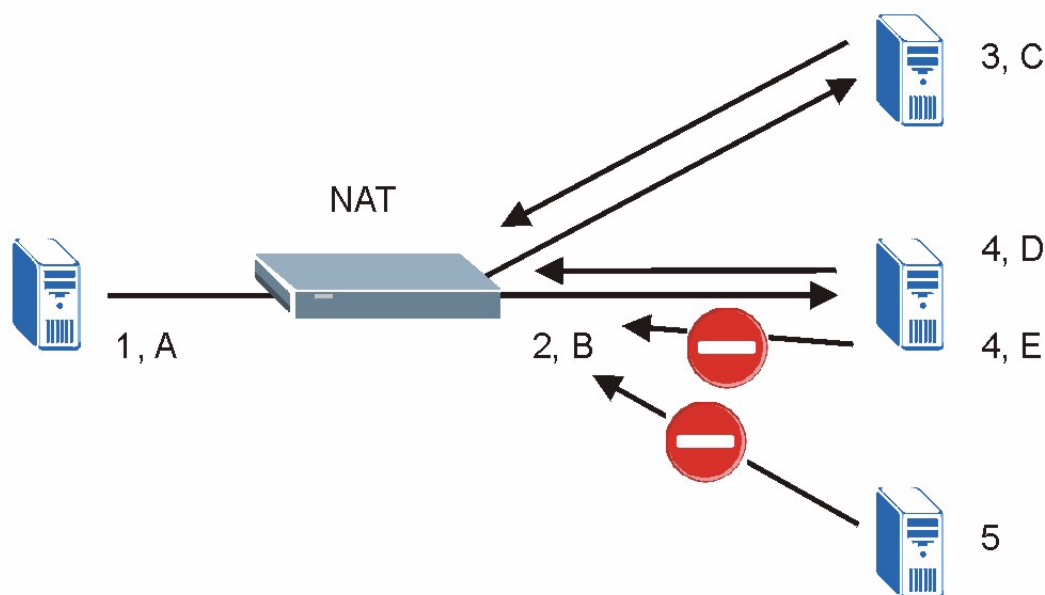

17.1.6 NAT Mapping Types

NAT supports five types of IP/port mapping. They are:

- **One to One:** In One-to-One mode, the ZyWALL maps one local IP address to one global IP address.
- **Many to One:** In Many-to-One mode, the ZyWALL maps multiple local IP addresses to one global IP address. This is equivalent to SUA (i.e., PAT, port address translation), ZyXEL's Single User Account feature (the **SUA** option).
- **Many to Many Overload:** In Many-to-Many Overload mode, the ZyWALL maps the multiple local IP addresses to shared global IP addresses.
- **Many One to One:** In Many-One-to-One mode, the ZyWALL maps each local IP address to a unique global IP address.

- **Server:** This type allows you to specify inside servers of different services behind the NAT to be accessible to the outside world although, it is highly recommended that you use the DMZ port for these servers instead.

Note: Port numbers do **not** change for **One-to-One** and **Many-One-to-One** NAT mapping types.

The following table summarizes these types.

Table 98 NAT Mapping Types

TYPE	IP MAPPING	SMT ABBREVIATION
One-to-One	ILA1↔IGA1	1-1
Many-to-One (SUA/PAT)	ILA1↔IGA1 ILA2↔IGA1 ...	M-1
Many-to-Many Overload	ILA1↔IGA1 ILA2↔IGA2 ILA3↔IGA1 ILA4↔IGA2 ...	M-M Ov
Many-One-to-One	ILA1↔IGA1 ILA2↔IGA2 ILA3↔IGA3 ...	M-1-1
Server	Server 1 IP↔IGA1 Server 2 IP↔IGA1 Server 3 IP↔IGA1	Server

17.2 Using NAT

Note: You must create a firewall rule in addition to setting up SUA/NAT, to allow traffic from the WAN to be forwarded through the ZyWALL.

17.2.1 SUA (Single User Account) Versus NAT

SUA (Single User Account) is a Zynos implementation of a subset of NAT that supports two types of mapping, **Many-to-One** and **Server**. The ZyWALL also supports **Full Feature** NAT to map multiple global IP addresses to multiple private LAN IP addresses of clients or servers using mapping types. Select either **SUA** or **Full Feature** in **NAT Overview**.

Selecting **SUA** means (latent) multiple WAN-to-LAN and WAN-to-DMZ address translation. That means that computers on your DMZ with public IP addresses will still have to undergo NAT mapping if you're using **SUA** NAT mapping. If this is not your intention, then select **Full Feature** NAT and don't configure NAT mapping rules to those computers with public IP addresses on the DMZ.

17.3 Configuring NAT Overview

Click **NAT** to open the **NAT Overview** screen shown next.

Figure 141 NAT Overview

The following table describes the labels in this screen.

Table 99 NAT Overview

LABEL	DESCRIPTION
Global Settings	
Max. Concurrent Sessions	This read-only field displays the highest number of NAT sessions that the ZyWALL will permit at one time.
Max. Concurrent Sessions Per Host	Use this field to set the highest number of NAT sessions that the ZyWALL will permit a host to have at one time.
WAN Operation Mode	This read-only field displays the operation mode of the ZyWALL's WAN ports.
WAN 1, 2	

Table 99 NAT Overview (continued)

LABEL	DESCRIPTION
Enable NAT	Select this check box to turn on the NAT feature for the WAN port. Clear this check box to turn off the NAT feature for the WAN port.
Address Mapping Rules	<p>Select SUA to have the ZyWALL use its permanent, pre-defined NAT address mapping rules.</p> <p>Select Full Feature to have the ZyWALL use the address mapping rules that you configure. This is the equivalent of what used to be called full feature NAT.</p> <p>The bar displays how many of the ZyWALL's possible address mapping rules are configured. The first number shows how many address mapping rules are configured on the ZyWALL. The second number shows the maximum number of address mapping rules that can be configured on the ZyWALL.</p>
Port Forwarding Rules	The bar displays how many of the ZyWALL's possible port forwarding rules are configured. The first number shows how many port forwarding rules are configured on the ZyWALL. The second number shows the maximum number of port forwarding rules that can be configured on the ZyWALL.
Port Triggering Rules	The bar displays how many of the ZyWALL's possible trigger port rules are configured. The first number shows how many trigger port rules are configured on the ZyWALL. The second number shows the maximum number of trigger port rules that can be configured on the ZyWALL.
Copy to WAN 2 (and Copy to WAN 1)	<p>Click Copy to WAN 2 (or Copy to WAN 1) to duplicate this WAN port's NAT port forwarding or trigger port rules on the other WAN port.</p> <p>Note: Using the copy button overwrites the other WAN port's existing rules.</p> <p>The copy button is best suited for initial NAT configuration where you have configured NAT port forwarding or trigger port rules for one port and want to use similar rules for the other WAN port. You can use the other NAT screens to edit the NAT rules after you copy them from one WAN port to the other.</p>
Apply	Click Apply to save your changes back to the ZyWALL.
Reset	Click Reset to begin configuring this screen afresh.

17.4 Configuring Address Mapping

Ordering your rules is important because the ZyWALL applies the rules in the order that you specify. When a rule matches the current packet, the ZyWALL takes the corresponding action and the remaining rules are ignored. If there are any empty rules before your new configured rule, your configured rule will be pushed up by that number of empty rules. For example, if you have already configured rules 1 to 6 in your current set and now you configure rule number 9. In the set summary screen, the new rule will be rule 7, not 9. Now if you delete rule 4, rules 5 to 7 will be pushed up by 1 rule, so old rules 5, 6 and 7 become new rules 4, 5 and 6.

To change your ZyWALL's Address Mapping settings, click **NAT**, then the **Address Mapping** tab. The screen appears as shown (some of the screen's blank rows are not shown).

Figure 142 Address Mapping

NAT

NAT Overview **Address Mapping** Port Forwarding Port Triggering

SUA Address Mapping Rules

#	Local Start IP	Local End IP	Global Start IP	Global End IP	Type
1	0.0.0.0	255.255.255.255	0.0.0.0	N/A	M-1
2	N/A	N/A	0.0.0.0	N/A	Server

Full Feature Address Mapping Rules

WAN Interface Go To Page

#	Local Start IP	Local End IP	Global Start IP	Global End IP	Type	Modify
1	192.168. 1. 10	N/A	10.132. 50. 1	N/A	1-1	
2	192.168. 1. 11	192.168. 1. 25	10.132. 50. 2	10.132. 50. 23	M-M Ov	
3	0. 0. 0. 0	255.255.255.255	0. 0. 0. 0	N/A	M-1	
4	N/A	N/A	0. 0. 0. 0	N/A	Server	
5	-	
6	-	
7	-	
8	-	
9	-	
10	-	

new rule before rule (rule number).

The following table describes the labels in this screen.

Table 100 Address Mapping

LABEL	DESCRIPTION
SUA Address Mapping Rules	This read-only table displays the default address mapping rules.
Full Feature Address Mapping Rules	
WAN Interface	Select the WAN port for which you want to view or configure address mapping rules.
Go To Page	Choose a page from the drop-down list box to display the corresponding summary page of address mapping rules.
#	This is the rule index number.
Local Start IP	This refers to the Inside Local Address (ILA), which is the starting local IP address. If the rule is for all local IP addresses, then this field displays 0.0.0.0 as the Local Start IP address. Local IP addresses are N/A for Server port mapping.
Local End IP	This is the end Inside Local Address (ILA). If the rule is for all local IP addresses, then this field displays 255.255.255.255 as the Local End IP address. This field is N/A for One-to-One and Server mapping types.

Table 100 Address Mapping (continued)

LABEL	DESCRIPTION
Global Start IP	This refers to the Inside Global IP Address (IGA), that is the starting global IP address. 0.0.0.0 is for a dynamic IP address from your ISP with Many-to-One and Server mapping types.
Global End IP	This is the ending Inside Global Address (IGA). This field is N/A for One-to-One , Many-to-One and Server mapping types.
Type	<ol style="list-style-type: none"> One-to-One mode maps one local IP address to one global IP address. Note that port numbers do not change for the One-to-One NAT mapping type. Many-to-One mode maps multiple local IP addresses to one global IP address. This is equivalent to SUA (i.e., PAT, port address translation), ZyXEL's Single User Account feature that previous ZyXEL routers supported only. Many-to-Many Overload mode maps multiple local IP addresses to shared global IP addresses. Many One-to-One mode maps each local IP address to unique global IP addresses. Server allows you to specify inside servers of different services behind the NAT to be accessible to the outside world.
Modify	Click the edit icon to go to the screen where you can edit the address mapping rule. Click the delete icon to delete an existing address mapping rule. A window display asking you to confirm that you want to delete the address mapping rule. Note that subsequent address mapping rules move up by one when you take this action.
Insert	Click Insert to insert a new mapping rule before an existing one.

17.4.1 Address Mapping Edit

To edit an address mapping rule, click the **Edit** button to display the screen shown next.

Figure 143 Address Mapping Edit

The screenshot shows a web-based configuration interface for NAT address mapping. The main window is titled "NAT - ADDRESS MAPPING". Inside, there is a sub-section titled "Address Mapping Rule". The configuration is as follows:

- Type:** A dropdown menu currently showing "One-to-One".
- Local Start IP:** A text input field containing "0 . 0 . 0 . 0".
- Local End IP:** A text input field containing "N/A".
- Global Start IP:** A text input field containing "0 . 0 . 0 . 0".
- Global End IP:** A text input field containing "N/A".

At the bottom of the configuration area, there are two buttons: "Apply" and "Cancel".

The following table describes the labels in this screen.

Table 101 Address Mapping Edit

LABEL	DESCRIPTION
Type	Choose the port mapping type from one of the following. <ol style="list-style-type: none"> 1. One-to-One: One-to-One mode maps one local IP address to one global IP address. Note that port numbers do not change for One-to-One NAT mapping type. 2. Many-to-One: Many-to-One mode maps multiple local IP addresses to one global IP address. This is equivalent to SUA (i.e., PAT, port address translation), ZyXEL's Single User Account feature. 3. Many-to-Many Overload: Many-to-Many Overload mode maps multiple local IP addresses to shared global IP addresses. 4. Many One-to-One: Many One-to-One mode maps each local IP address to unique global IP addresses. 5. Server: This type allows you to specify inside servers of different services behind the NAT to be accessible to the outside world.
Local Start IP	This is the starting Inside Local IP Address (ILA). Local IP addresses are N/A for Server port mapping.
Local End IP	This is the end Inside Local IP Address (ILA). If your rule is for all local IP addresses, then enter 0.0.0.0 as the Local Start IP address and 255.255.255.255 as the Local End IP address. This field is N/A for One-to-One and Server mapping types.
Global Start IP	This is the starting Inside Global IP Address (IGA). Enter 0.0.0.0 here if you have a dynamic IP address from your ISP.
Global End IP	This is the ending Inside Global IP Address (IGA). This field is N/A for One-to-One , Many-to-One and Server mapping types.
Apply	Click Apply to save your changes back to the ZyWALL.
Cancel	Click Cancel to exit this screen without saving.

17.5 Port Forwarding

A port forwarding set is a list of inside (behind NAT on the LAN) servers, for example, web or FTP, that you can make visible to the outside world even though NAT makes your whole inside network appear as a single computer to the outside world.

You may enter a single port number or a range of port numbers to be forwarded, and the local IP address of the desired server. The port number identifies a service; for example, web service is on port 80 and FTP on port 21. In some cases, such as for unknown services or where one server can support more than one service (for example both FTP and web service), it might be better to specify a range of port numbers. You can allocate a server IP address that corresponds to a port or a range of ports.

Many residential broadband ISP accounts do not allow you to run any server processes (such as a Web or FTP server) from your location. Your ISP may periodically check for servers and may suspend your account if it discovers any active services at your location. If you are unsure, refer to your ISP.

17.5.1 Default Server IP Address

In addition to the servers for specified services, NAT supports a default server IP address. A default server receives packets from ports that are not specified in this screen.

Note: If you do not assign a **Default Server IP** address, the ZyWALL discards all packets received for ports that are not specified here or in the remote management setup.

17.5.2 Port Forwarding: Services and Port Numbers

The ZyWALL provides the additional safety of the DMZ ports for connecting your publicly accessible servers. This makes the LAN more secure by physically separating it from your public servers.

Use the **Port Forwarding** screen to forward incoming service requests to the server(s) on your local network.

The most often used port numbers are shown in the following table. Please refer to RFC 1700 for further information about port numbers. Please also refer to the Supporting CD for more examples and details on port forwarding and NAT.

Table 102 Services and Port Numbers

SERVICES	PORT NUMBER
ECHO	7
FTP (File Transfer Protocol)	21
SMTP (Simple Mail Transfer Protocol)	25
DNS (Domain Name System)	53
Finger	79
HTTP (Hyper Text Transfer protocol or WWW, Web)	80
POP3 (Post Office Protocol)	110
NNTP (Network News Transport Protocol)	119
SNMP (Simple Network Management Protocol)	161
SNMP trap	162
PPTP (Point-to-Point Tunneling Protocol)	1723

17.5.3 Configuring Servers Behind Port Forwarding (Example)

Let's say you want to assign ports 21-25 to one FTP, Telnet and SMTP server (**A** in the example), port 80 to another (**B** in the example) and assign a default server IP address of 192.168.1.35 to a third (**C** in the example). You assign the LAN IP addresses and the ISP assigns the WAN IP address. The NAT network appears as a single host on the Internet.

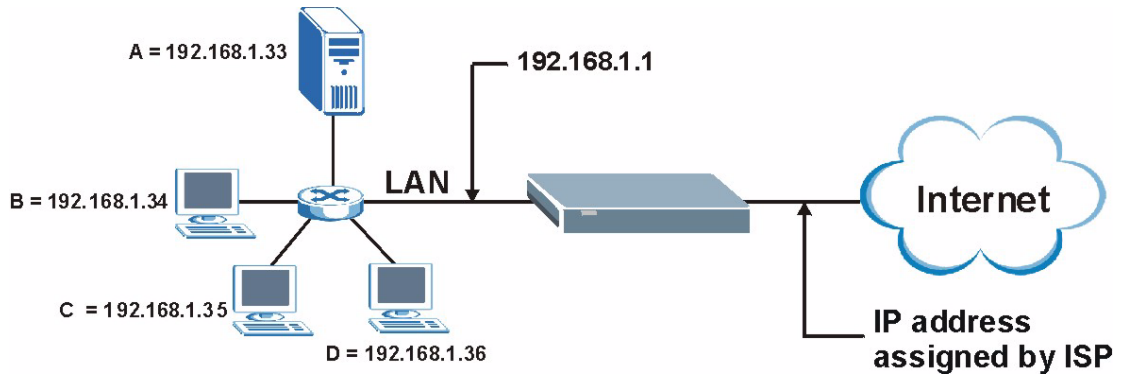
Figure 144 Multiple Servers Behind NAT Example

17.5.4 NAT and Multiple WAN

The ZyWALL has two WAN ports. You can configure port forwarding and trigger port rule sets for the first WAN port and separate sets of rules for the second WAN port.

17.5.5 Port Translation

The ZyWALL can translate the destination port number or a range of port numbers of packets coming from the WAN to another destination port number or range of port numbers on the LAN (or DMZ). When you use port forwarding without port translation, a single server on the LAN or DMZ can use a specific port number and be accessible to the outside world through a single WAN IP address. When you use port translation with port forwarding, multiple servers on the LAN or DMZ can use the same port number and still be accessible to the outside world through a single WAN IP address.

The following example has two web servers on a LAN. Server **A** uses IP address 192.168.1.33 and server **B** uses 192.168.1.34. Both servers use port 80. The letters a.b.c.d represent the WAN port's IP address. The ZyWALL translates port 8080 of traffic received on the WAN port (IP address a.b.c.d) to port 80 and sends it to server **A** (IP address 192.168.1.33). The ZyWALL also translates port 8100 of traffic received on the WAN port (also IP address a.b.c.d) to port 80, but sends it to server **B** (IP address 192.168.1.34).

Note: In this example, anyone wanting to access server A from the Internet must use port 8080. Anyone wanting to access server B from the Internet must use port 8100.

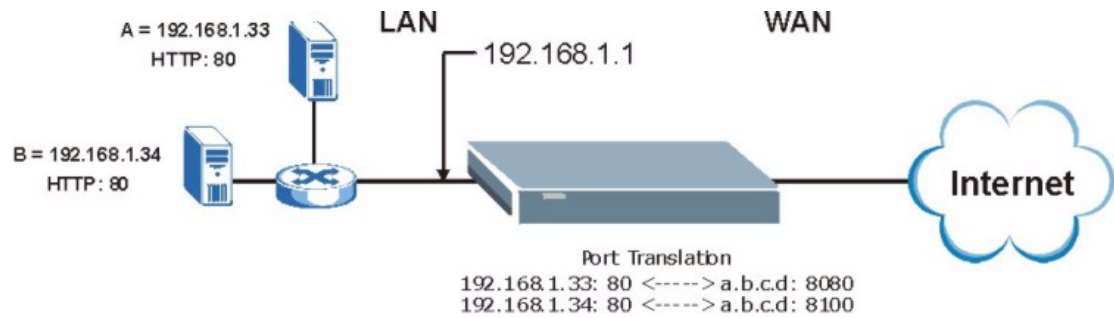
Figure 145 Port Translation Example

17.6 Configuring Port Forwarding

Note: If you do not assign a **Default Server** IP address, the ZyWALL discards all packets received for ports that are not specified here or in the remote management setup.

Click **NAT** and **Port Forwarding** to open the **Port Forwarding** screen.

Refer to [Figure 102 on page 307](#) for port numbers commonly used for particular services.

Note: The last port forwarding rule is reserved for Roadrunner services. The rule is activated only when you set the **WAN Encapsulation** to **Ethernet** and the **Service Type** to something other than **Standard**.

Figure 146 Port Forwarding

NAT

NAT Overview | Address Mapping | **Port Forwarding** | Port Triggering

Port Forwarding Rules

WAN Interface: WAN 1

Default Server: 0 . 0 . 0 . 0

Go To Page: 1

#	Active	Name	Incoming Port(s)	Port Translation	Server IP Address
1	<input checked="" type="checkbox"/>	1	80 - 80	0 - 0	192 . 168 . 1 . 21
2	<input checked="" type="checkbox"/>	2	25 - 25	0 - 0	192 . 168 . 1 . 20
3	<input type="checkbox"/>		0 - 0	0 - 0	0 . 0 . 0 . 0
4	<input type="checkbox"/>		0 - 0	0 - 0	0 . 0 . 0 . 0
5	<input type="checkbox"/>		0 - 0	0 - 0	0 . 0 . 0 . 0
6	<input type="checkbox"/>		0 - 0	0 - 0	0 . 0 . 0 . 0
7	<input type="checkbox"/>		0 - 0	0 - 0	0 . 0 . 0 . 0
8	<input type="checkbox"/>		0 - 0	0 - 0	0 . 0 . 0 . 0
9	<input type="checkbox"/>		0 - 0	0 - 0	0 . 0 . 0 . 0
10	<input type="checkbox"/>		0 - 0	0 - 0	0 . 0 . 0 . 0

Note 1: You may also need to create a [Firewall](#) rule.
 Note 2: Port Translation is optional.

Apply | Reset

The following table describes the labels in this screen.

Table 103 Port Forwarding

LABEL	DESCRIPTION
WAN Interface	Select the WAN port for which you want to view or configure address mapping rules.
Default Server	In addition to the servers for specified services, NAT supports a default server. A default server receives packets from ports that are not specified in this screen. If you do not assign a Default Server IP address, the ZyWALL discards all packets received for ports that are not specified here or in the remote management setup.
Go To Page	Choose a page from the drop-down list box to display the corresponding summary page of the port forwarding servers.
#	This is the number of an individual port forwarding server entry.
Active	Select this check box to enable the port forwarding server entry. Clear this check box to disallow forwarding of these ports to an inside server without having to delete the entry.
Name	Enter a name to identify this port-forwarding rule.
Incoming Port(s)	Enter a port number here. To forward only one port, enter it again in the second field. To specify a range of ports, enter the last port to be forwarded in the second field.
Port Translation	Enter the port number here to which you want the ZyWALL to translate the incoming port. For a range of ports, you only need to enter the first number of the range to which you want the incoming ports translated, the ZyWALL automatically calculates the last port of the translated port range.

Table 103 Port Forwarding

LABEL	DESCRIPTION
Server IP Address	Enter the inside IP address of the server here.
Apply	Click Apply to save your changes back to the ZyWALL.
Reset	Click Reset to begin configuring this screen afresh.

17.7 Configuring Trigger Port

Some services use a dedicated range of ports on the client side and a dedicated range of ports on the server side. With regular port forwarding you set a forwarding port in NAT to forward a service (coming in from the server on the WAN) to the IP address of a computer on the client side (LAN). The problem is that port forwarding only forwards a service to a single LAN IP address. In order to use the same service on a different LAN computer, you have to manually replace the LAN computer's IP address in the forwarding port with another LAN computer's IP address.

Trigger port forwarding solves this problem by allowing computers on the LAN to dynamically take turns using the service. The ZyWALL records the IP address of a LAN computer that sends traffic to the WAN to request a service with a specific port number and protocol (a "trigger" port). When the ZyWALL's WAN port receives a response with a specific port number and protocol ("incoming" port), the ZyWALL forwards the traffic to the LAN IP address of the computer that sent the request. After that computer's connection for that service closes, another computer on the LAN can use the service in the same manner. This way you do not need to configure a new IP address each time you want a different LAN computer to use the application.

For example:

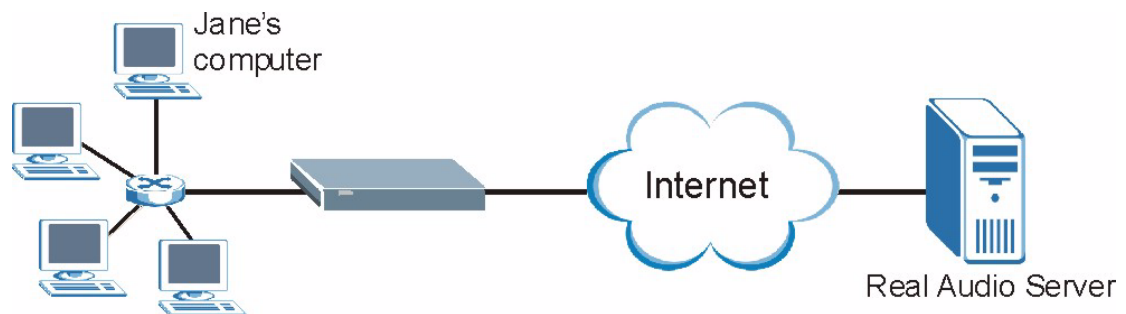
Figure 147 Trigger Port Forwarding Process: Example

- 1 Jane requests a file from the Real Audio server (port 7070).
- 2 Port 7070 is a "trigger" port and causes the ZyWALL to record Jane's computer IP address. The ZyWALL associates Jane's computer IP address with the "incoming" port range of 6970-7170.
- 3 The Real Audio server responds using a port number ranging between 6970-7170.

- 4 The ZyWALL forwards the traffic to Jane's computer IP address.
- 5 Only Jane can connect to the Real Audio server until the connection is closed or times out. The ZyWALL times out in three minutes with UDP (User Datagram Protocol) or two hours with TCP/IP (Transfer Control Protocol/Internet Protocol).

To change your ZyWALL's trigger port settings, click **NAT** and the **Port Triggering** tab. The screen appears as shown.

Figure 148 Port Triggering

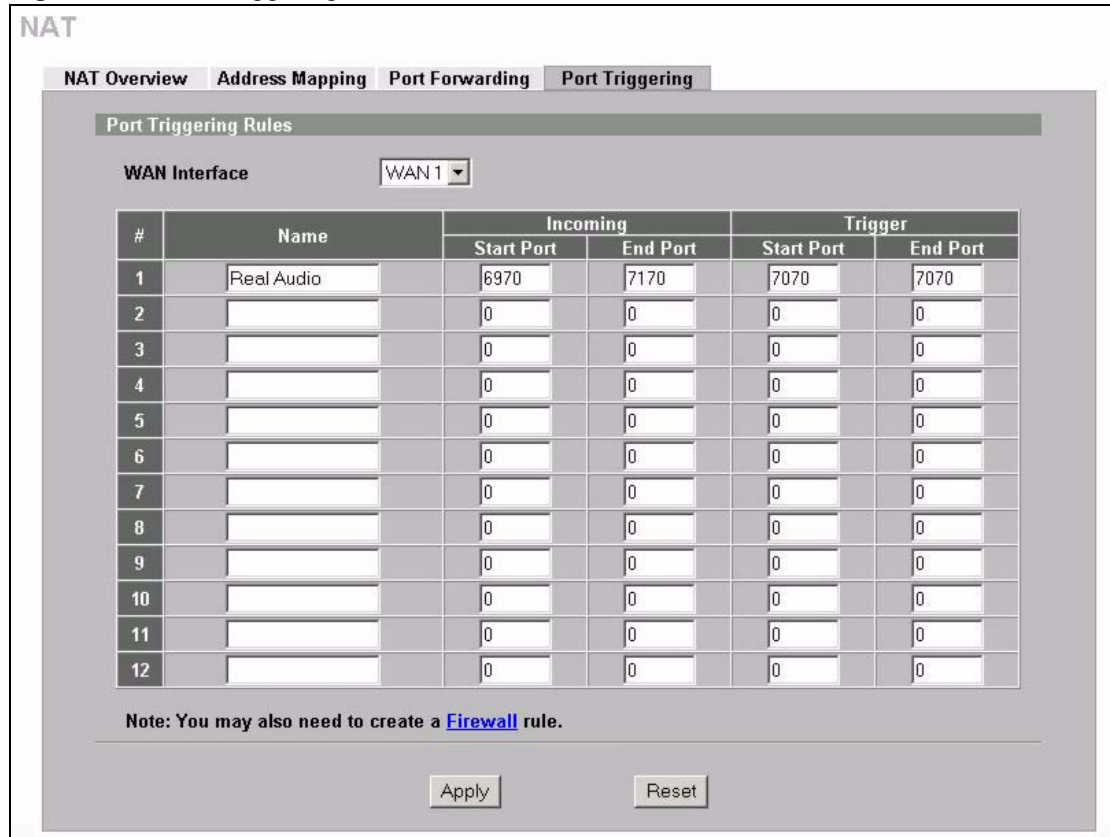

The following table describes the labels in this screen.

Table 104 Port Triggering

LABEL	DESCRIPTION
WAN Interface	Select the WAN port for which you want to view or configure address mapping rules.
#	This is the rule index number (read-only).
Name	Type a unique name (up to 15 characters) for identification purposes. All characters are permitted - including spaces.
Incoming	Incoming is a port (or a range of ports) that a server on the WAN uses when it sends out a particular service. The ZyWALL forwards the traffic with this port (or range of ports) to the client computer on the LAN that requested the service.
Start Port	Type a port number or the starting port number in a range of port numbers.
End Port	Type a port number or the ending port number in a range of port numbers.

Table 104 Port Triggering

LABEL	DESCRIPTION
Trigger	The trigger port is a port (or a range of ports) that causes (or triggers) the ZyWALL to record the IP address of the LAN computer that sent the traffic to a server on the WAN.
Start Port	Type a port number or the starting port number in a range of port numbers.
End Port	Type a port number or the ending port number in a range of port numbers.
Apply	Click Apply to save your changes back to the ZyWALL.
Reset	Click Reset to begin configuring this screen afresh.

CHAPTER 18

Static Route

This chapter shows you how to configure static routes for your ZyWALL.

18.1 Static Route Overview

Each remote node specifies only the network to which the gateway is directly connected, and the ZyWALL has no knowledge of the networks beyond. For instance, the ZyWALL knows about network N2 in the following figure through remote node Router 1. However, the ZyWALL is unable to route a packet to network N3 because it doesn't know that there is a route through the same remote node Router 1 (via gateway Router 2). The static routes are for you to tell the ZyWALL about the networks beyond the remote nodes.

Figure 149 Example of Static Routing Topology

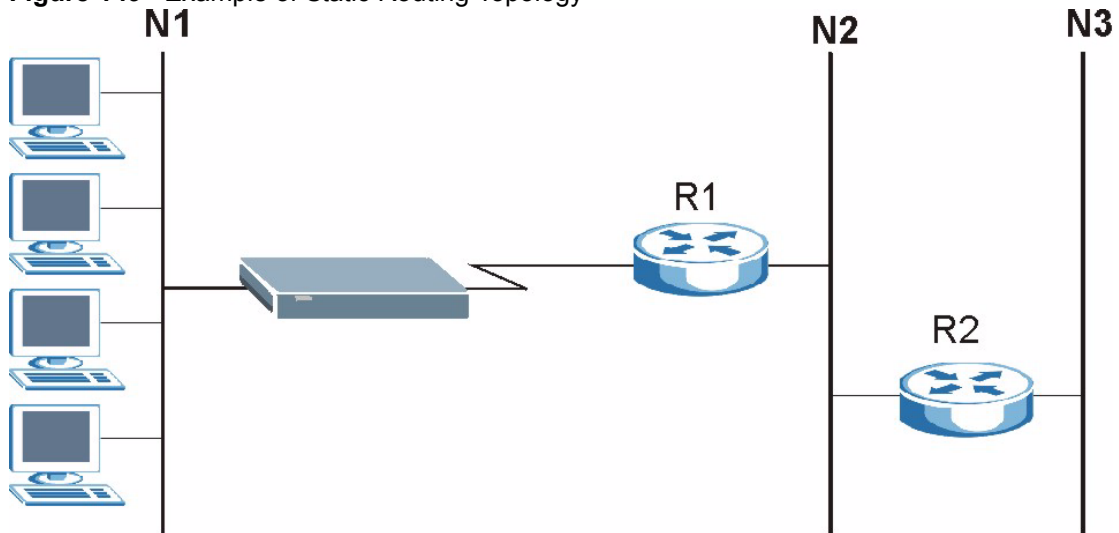

18.2 Configuring IP Static Route

Click **STATIC ROUTE** to open the **IP Static Route** screen (some of the screen's blank rows are not shown).

Note: The first two static route entries are for default WAN1 and WAN2 routes and cannot be modified or deleted. The name of each default static route is left blank unless you configure a static WAN IP address.

Note: The default route is disabled after you change the static WAN IP address to a dynamic WAN IP address.

Figure 150 IP Static Route

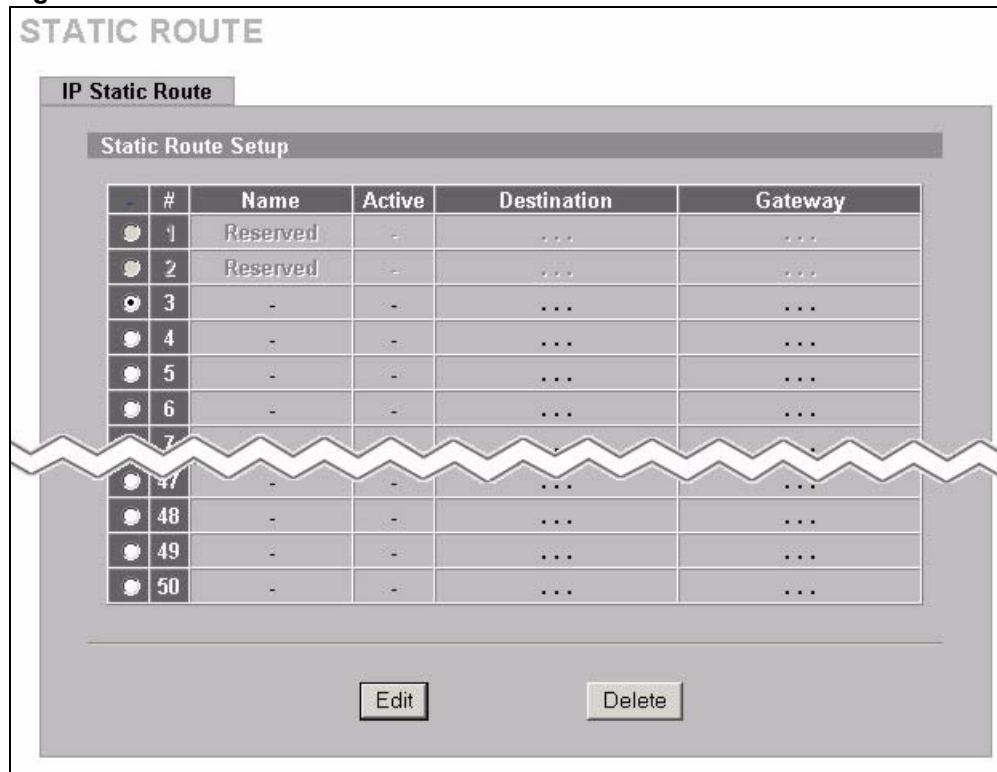

The following table describes the labels in this screen.

Table 105 IP Static Route

LABEL	DESCRIPTION
#	This is the number of an individual static route.
Name	This is the name that describes or identifies this route.
Active	This field shows whether this static route is active (Yes) or not (No).
Destination	This parameter specifies the IP network address of the final destination. Routing is always based on network number.
Gateway	This is the IP address of the gateway. The gateway is a router or switch on the same network segment as the device's LAN or WAN port. The gateway helps forward packets to their destinations.
Edit	Select the radio button next to a static route index number and then click Edit to set up a static route on the ZyWALL.
Delete	Select the radio button next to a static route index number and then click Delete to remove a static route on the ZyWALL.

18.2.1 Configuring a Static Route Entry

Select a static route index number and click **Edit**. The screen shown next appears. Fill in the required information for each static route.

Figure 151 Edit IP Static Route

The following table describes the labels in this screen.

Table 106 Edit IP Static Route

LABEL	DESCRIPTION
Route Name	Enter the name of the IP static route. Leave this field blank to delete this static route.
Active	This field allows you to activate/deactivate this static route.
Destination IP Address	This parameter specifies the IP network address of the final destination. Routing is always based on network number. If you need to specify a route to a single host, use a subnet mask of 255.255.255.255 in the subnet mask field to force the network number to be identical to the host ID.
IP Subnet Mask	Enter the IP subnet mask here.
Gateway IP Address	Enter the IP address of the gateway. The gateway is a router or switch on the same network segment as the device's LAN or WAN port. The gateway helps forward packets to their destinations.
Metric	Metric represents the "cost" of transmission for routing purposes. IP routing uses hop count as the measurement of cost, with a minimum of 1 for directly connected networks. Enter a number that approximates the cost for this link. The number need not be precise, but it must be between 1 and 15. In practice, 2 or 3 is usually a good number.
Private	This parameter determines if the ZyWALL will include this route to a remote node in its RIP broadcasts. Select this check box to keep this route private and not included in RIP broadcasts. Clear this check box to propagate this route to other hosts through RIP broadcasts.
Apply	Click Apply to save your changes back to the ZyWALL.
Cancel	Click Cancel to exit this screen without saving.

CHAPTER 19

Policy Route

This chapter covers setting and applying policies used for IP routing.

19.1 Introduction to IP Policy Routing

Traditionally, routing is based on the destination address only and the ZyWALL takes the shortest path to forward a packet. IP Policy Routing (IPPR) provides a mechanism to override the default routing behavior and alter the packet forwarding based on the policy defined by the network administrator. Policy-based routing is applied to incoming packets on a per interface basis, prior to the normal routing.

19.2 Benefits

- Source-Based Routing – Network administrators can use policy-based routing to direct traffic from different users through different connections.
- Quality of Service (QoS) – Organizations can differentiate traffic by setting the precedence or ToS (Type of Service) values in the IP header at the periphery of the network to enable the backbone to prioritize traffic.
- Cost Savings – IPPR allows organizations to distribute interactive traffic on high-bandwidth, high-cost paths while using low-cost paths for batch traffic.
- Load Sharing – Network administrators can use IPPR to distribute traffic among multiple paths.

19.3 Routing Policy

Individual routing policies are used as part of the overall IPPR process. A policy defines the matching criteria and the action to take when a packet meets the criteria. The action is taken only when all the criteria are met. The criteria include the source address and port, IP protocol (ICMP, UDP, TCP, etc.), destination address and port, ToS and precedence (fields in the IP header) and length. The inclusion of length criterion is to differentiate between interactive and bulk traffic. Interactive applications, e.g., telnet, tend to have short packets, while bulk traffic, e.g., file transfer, tends to have large packets.

The actions that can be taken include:

- Routing the packet to a different gateway (and hence the outgoing interface).
- Setting the ToS and precedence fields in the IP header.

IPPR follows the existing packet filtering facility of RAS in style and in implementation.

19.4 IP Routing Policy Setup

Click **POLICY ROUTE** to open the **Policy Route Summary** screen (some of the screen's blank rows are not shown).

Figure 152 Policy Route Summary

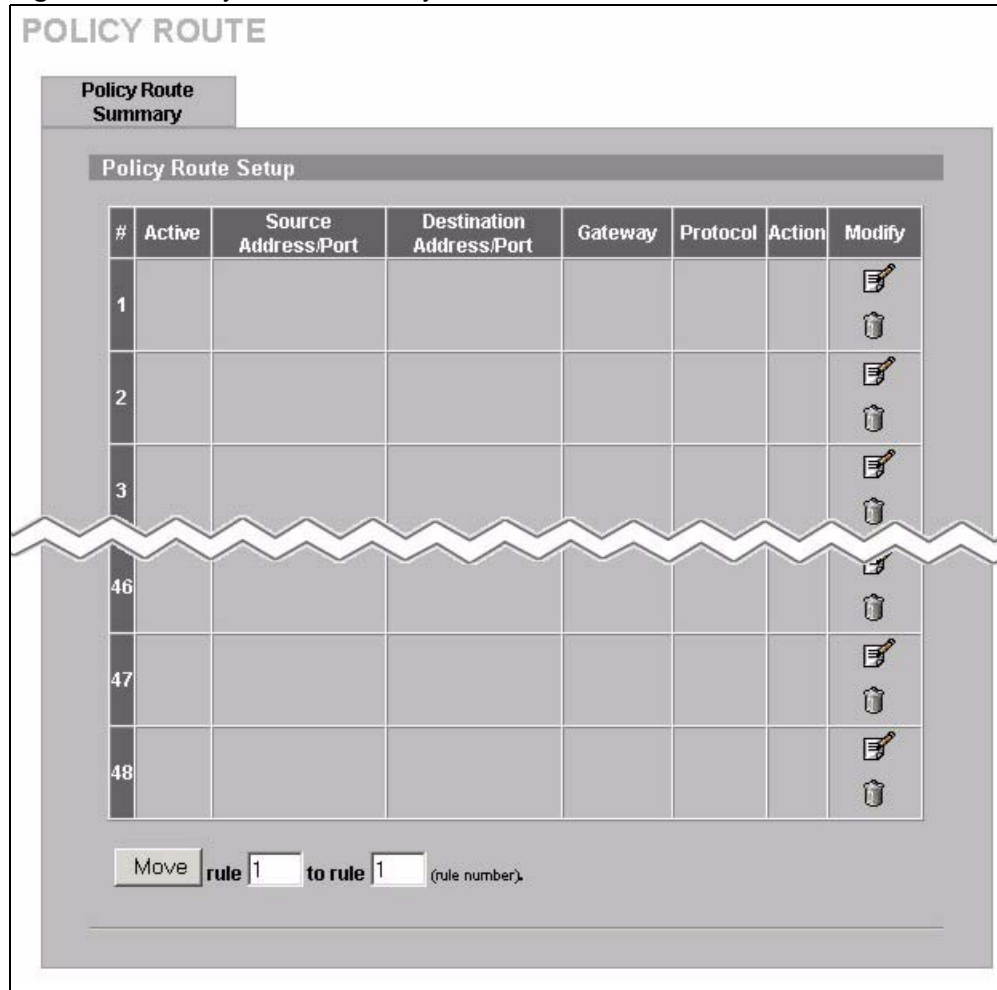

The following table describes the labels in this screen.

Table 107 Policy Route Setup

LABEL	DESCRIPTION
#	This is the number of an individual policy route.
Active	This field shows whether the policy is active or inactive.

Table 107 Policy Route Setup

LABEL	DESCRIPTION
Source Address/ Port	This is the source IP address range and/or port number range.
Destination Address/Port	This is the destination IP address range and/or port number range.
Gateway	Enter the IP address of the gateway. The gateway is a router or switch on the same network segment as the device's LAN or WAN port. The gateway helps forward packets to their destinations.
Protocol	This is the IP protocol and can be ICMP, UDP, TCP or ALL .
Action	This field specifies whether action should be taken on criteria Matched or Not Matched .
Modify	Click the edit icon to go to the screen where you can edit the routing policy on the ZyWALL. Click the delete icon to remove an existing routing policy from the ZyWALL. A window display asking you to confirm that you want to delete the address mapping rule.
Move	Type a policy route's index number and the number for where you want to put that rule. Click Move to move the rule to the number that you typed. The ordering of your rules is important as they are applied in order of their numbering.

19.5 Configuring the IP Policy Route Entry

Click the edit icon to open the screen as shown next.

Figure 153 Edit IP Policy Route

The following table describes the labels in this screen.

Table 108 Edit IP Policy Route

LABEL	DESCRIPTION
Criteria	
Active	Select the check box to activate the policy.
Rule Index	This is the index number of the policy route.
IP Protocol	Select Predefined and then the IP protocol from ALL(0), ICMP(1), IGMP(2), TCP(6), UDP(17), GRE(47), ESP(50) or AH(51) . Otherwise, select Custom and enter a number from 0 to 255.
Type of Service	Prioritize incoming network traffic by choosing from Any, Normal, Min Delay, Max Thruput, Max Reliable or Mix Cost .
Precedence	Precedence value of the incoming packet. Select a value from 0 to 7 or Any .

Table 108 Edit IP Policy Route (continued)

LABEL	DESCRIPTION
Packet Length	Type a length of packet (in bytes). The operators in the Len Compare field apply to incoming packets of this length.
Length Comparison	Choose from Equal, Not Equal, Less, Greater, Less or Equal or Greater or Equal .
Source	
Interface	Use the check box to select LAN, DMZ, WAN_1 and/or WAN_2 .
Starting IP Address	Enter the source starting IP address.
Ending IP Address	Enter the source ending IP address.
Starting Port	Enter the source starting port number. This field is applicable only when you select TCP or UDP in the IP Protocol field.
Ending Port	Enter the source ending port number. This field is applicable only when you select TCP or UDP in the IP Protocol field.
Destination	
Starting IP Address	Enter the destination starting IP address.
Ending IP Address	Enter the destination ending IP address.
Starting Port	Enter the destination starting port number. This field is applicable only when you select TCP or UDP in the IP Protocol field.
Ending Port	Enter the destination ending port number. This field is applicable only when you select TCP or UDP in the IP Protocol field.
Action Applies to	Specifies whether action should be taken on criteria Matched or Not Matched .
Routing Action	
Gateway	<p>Select User-Defined and enter the IP address of the gateway if you want to specify the IP address of the gateway. The gateway is an immediate neighbor of your ZyWALL that will forward the packet to the destination. The gateway must be a router on the same segment as your ZyWALL's LAN or WAN port.</p> <p>Select WAN Interface to have the ZyWALL send traffic that matches the policy route through a specific WAN port. Select the WAN port from the drop-down list box.</p> <p>Select the Use another interface when the specified WAN interface is not available. check box to have the ZyWALL send traffic that matches the policy route through the other WAN interface if it cannot send the traffic through the WAN interface you selected. This option is only available when you select WAN Interface.</p>
Converted Type of Service	Set the new TOS value of the outgoing packet. Prioritize incoming network traffic by choosing Don't Change, Normal, Min Delay, Max Thruput, Max Reliable or Min Cost .
Converted Precedence	Set the new outgoing packet precedence value. Values are 0 to 7 or Don't Change .
Log	Select Yes from the drop-down list box to make an entry in the system log when a policy is executed.
Apply	Click Apply to save your changes back to the ZyWALL.
Cancel	Click Cancel to exit this screen without saving.

CHAPTER 20

Bandwidth Management

This chapter describes the functions and configuration of bandwidth management with multiple levels of sub-classes.

20.1 Bandwidth Management Overview

Bandwidth management allows you to allocate an interface's outgoing capacity to specific types of traffic. It can also help you make sure that the ZyWALL forwards certain types of traffic (especially real-time applications) with minimum delay. With the use of real-time applications such as Voice-over-IP (VoIP) increasing, the requirement for bandwidth allocation is also increasing.

Bandwidth management addresses questions such as:

- Who gets how much access to specific applications?
- What priority level should you give to each type of traffic?
- Which traffic must have guaranteed delivery?
- How much bandwidth should be allotted to guarantee delivery?

Bandwidth management also allows you to configure the allowed output for an interface to match what the network can handle. This helps reduce delays and dropped packets at the next routing device. For example, you can set the WAN interface speed to 1024 kbps (or less) if the broadband device connected to the WAN port has an upstream speed of 1024 kbps.

20.2 Bandwidth Classes and Filters

Use bandwidth classes and sub-classes to allocate specific amounts of bandwidth capacity (bandwidth budgets). Configure a bandwidth filter to define a bandwidth class (or sub-class) based on a specific application and/or subnet. Use the **Class Setup** screen (see [Section 20.11.1 on page 334](#)) to set up a bandwidth class's name, bandwidth allotment, and bandwidth filter. You can configure up to one bandwidth filter per bandwidth class. You can also configure bandwidth classes without bandwidth filters. However, it is recommended that you configure sub-classes with filters for any classes that you configure without filters. The ZyWALL leaves the bandwidth budget allocated and unused for a class that does not have a filter or sub-classes with filters. View your configured bandwidth classes and sub-classes in the **Class Setup** screen (see [Section 20.11 on page 332](#) for details).

The total of the configured bandwidth budgets for sub-classes cannot exceed the configured bandwidth budget speed of the parent class.

20.3 Proportional Bandwidth Allocation

Bandwidth management allows you to define how much bandwidth each class gets; however, the actual bandwidth allotted to each class decreases or increases in proportion to actual available bandwidth.

20.4 Application-based Bandwidth Management

You can create bandwidth classes based on individual applications (like VoIP, Web, FTP, E-mail and Video for example).

20.5 Subnet-based Bandwidth Management

You can create bandwidth classes based on subnets. The following figure shows LAN subnets. You could configure one bandwidth class for subnet A and another for subnet B.

Figure 154 Subnet-based Bandwidth Management Example

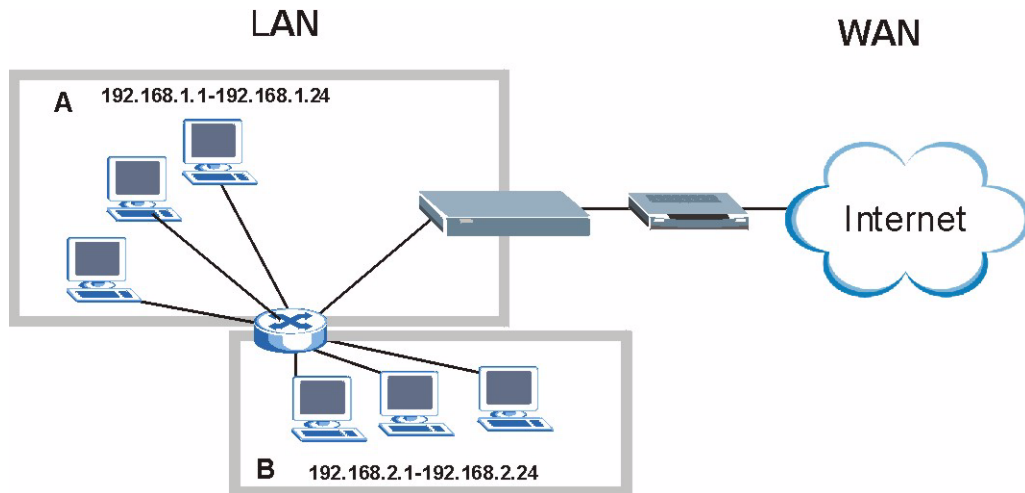

20.6 Application and Subnet-based Bandwidth Management

You could also create bandwidth classes based on a combination of a subnet and an application. The following example table shows bandwidth allocations for application specific traffic from separate LAN subnets.

Table 109 Application and Subnet-based Bandwidth Management Example

TRAFFIC TYPE	FROM SUBNET A	FROM SUBNET B
VoIP	64 Kbps	64 Kbps
Web	64 Kbps	64 Kbps

Table 109 Application and Subnet-based Bandwidth Management Example (continued)

TRAFFIC TYPE	FROM SUBNET A	FROM SUBNET B
FTP	64 Kbps	64 Kbps
E-mail	64 Kbps	64 Kbps
Video	64 Kbps	64 Kbps

20.7 Scheduler

The scheduler divides up an interface's bandwidth among the bandwidth classes. The ZyWALL has two types of scheduler: fairness-based and priority-based.

20.7.1 Priority-based Scheduler

With the priority-based scheduler, the ZyWALL forwards traffic from bandwidth classes according to the priorities that you assign to the bandwidth classes. The larger a bandwidth class's priority number is, the higher the priority. Assign real-time applications (like those using audio or video) a higher priority number to provide smoother operation.

20.7.2 Fairness-based Scheduler

The ZyWALL divides bandwidth equally among bandwidth classes when using the fairness-based scheduler; thus preventing one bandwidth class from using all of the interface's bandwidth.

20.8 Maximize Bandwidth Usage

The maximize bandwidth usage option (see [Figure 155 on page 331](#)) allows the ZyWALL to divide up any available bandwidth on the interface (including unallocated bandwidth and any allocated bandwidth that a class is not using) among the bandwidth classes that require more bandwidth.

When you enable maximize bandwidth usage, the ZyWALL first makes sure that each bandwidth class gets up to its bandwidth allotment. Next, the ZyWALL divides up an interface's available bandwidth (bandwidth that is unbudgeted or unused by the classes) depending on how many bandwidth classes require more bandwidth and on their priority levels. When only one class requires more bandwidth, the ZyWALL gives extra bandwidth to that class.

When multiple classes require more bandwidth, the ZyWALL gives the highest priority classes the available bandwidth first (as much as they require, if there is enough available bandwidth), and then to lower priority classes if there is still bandwidth available. The ZyWALL distributes the available bandwidth equally among classes with the same priority level.

20.8.1 Reserving Bandwidth for Non-Bandwidth Class Traffic

Do the following three steps to configure the ZyWALL to allow bandwidth for traffic that is not defined in a bandwidth filter.

- 1 Leave some of the interface's bandwidth unbudgeted.
- 2 Do not enable the interface's **Maximize Bandwidth Usage** option.
- 3 Do not enable bandwidth borrowing on the sub-classes that have the root class as their parent (see [Section 20.9 on page 329](#)).

20.8.2 Maximize Bandwidth Usage Example

Here is an example of a ZyWALL that has maximize bandwidth usage enabled on an interface. The following table shows each bandwidth class's bandwidth budget. The classes are set up based on subnets. The interface is set to 10240 kbps. Each subnet is allocated 2048 kbps. The unbudgeted 2048 kbps allows traffic not defined in any of the bandwidth filters to go out when you do not select the maximize bandwidth option.

Table 110 Maximize Bandwidth Usage Example

BANDWIDTH CLASSES AND ALLOTMENTS	
Root Class: 10240 kbps	Administration: 2048 kbps
	Sales: 2048 kbps
	Marketing: 2048 kbps
	Research: 2048 kbps

The ZyWALL divides up the unbudgeted 2048 kbps among the classes that require more bandwidth. If the administration department only uses 1024 kbps of the budgeted 2048 kbps, the ZyWALL also divides the remaining 1024 kbps among the classes that require more bandwidth. Therefore, the ZyWALL divides a total of 3072 kbps of unbudgeted and unused bandwidth among the classes that require more bandwidth.

20.8.2.1 Priority-based Allotment of Unused and Unbudgeted Bandwidth

The following table shows the priorities of the bandwidth classes and the amount of bandwidth that each class gets.

Table 111 Priority-based Allotment of Unused and Unbudgeted Bandwidth Example

BANDWIDTH CLASSES, PRIORITIES AND ALLOTMENTS	
Root Class: 10240 kbps	Administration: Priority 4, 1024 kbps
	Sales: Priority 6, 3584 kbps
	Marketing: Priority 6, 3584 kbps
	Research: Priority 5, 2048 kbps

Suppose that all of the classes except for the administration class need more bandwidth.

- Each class gets up to its budgeted bandwidth. The administration class only uses 1024 kbps of its budgeted 2048 kbps.
- The sales and marketing are first to get extra bandwidth because they have the highest priority (6). If they each require 1536 kbps or more of extra bandwidth, the ZyWALL divides the total 3072 kbps total of unbudgeted and unused bandwidth equally between the sales and marketing departments (1536 kbps extra to each for a total of 3584 kbps for each) because they both have the highest priority level.
- Research requires more bandwidth but only gets its budgeted 2048 kbps because all of the unbudgeted and unused bandwidth goes to the higher priority sales and marketing classes.

20.8.2.2 Fairness-based Allotment of Unused and Unbudgeted Bandwidth

The following table shows the amount of bandwidth that each class gets.

Table 112 Fairness-based Allotment of Unused and Unbudgeted Bandwidth Example

BANDWIDTH CLASSES AND ALLOTMENTS	
Root Class: 10240 kbps	Administration: 1024 kbps
	Sales: 3072 kbps
	Marketing: 3072 kbps
	Research: 3072 kbps

Suppose that all of the classes except for the administration class need more bandwidth.

- Each class gets up to its budgeted bandwidth. The administration class only uses 1024 kbps of its budgeted 2048 kbps.
- The ZyWALL divides the total 3072 kbps total of unbudgeted and unused bandwidth equally among the other classes. 1024 kbps extra goes to each so the other classes each get a total of 3072 kbps.

20.9 Bandwidth Borrowing

Bandwidth borrowing allows a sub-class to borrow unused bandwidth from its parent class, whereas maximize bandwidth usage allows bandwidth classes to borrow any unused or unbudgeted bandwidth on the whole interface.

Enable bandwidth borrowing on a sub-class to allow the sub-class to use its parent class's unused bandwidth. A parent class's unused bandwidth is given to the highest priority sub-class first. The sub-class can also borrow bandwidth from a higher parent class (grandparent class) if the sub-class's parent class is also configured to borrow bandwidth from its parent class. This can go on for as many levels as are configured to borrow bandwidth from their parent class (see [Section 20.9.1 on page 330](#)).

The total of the bandwidth allotments for sub-classes cannot exceed the bandwidth allotment of their parent class. The ZyWALL uses the scheduler to divide a parent class's unused bandwidth among the sub-classes.

20.9.1 Bandwidth Borrowing Example

Here is an example of bandwidth management with classes configured for bandwidth borrowing. The classes are set up based on departments and individuals within certain departments.

Table 113 Bandwidth Borrowing Example

BANDWIDTH CLASSES AND BANDWIDTH BORROWING SETTINGS			
Root Class:	Administration: Borrowing Enabled		
	Sales: Borrowing Disabled	Sales USA: Borrowing Enabled	Bill: Borrowing Enabled
			Amy: Borrowing Disabled
		Sales Asia: Borrowing Disabled	Tina: Borrowing Enabled
			Fred: Borrowing Disabled
	Marketing: Borrowing Enabled		
	Research: Borrowing Enabled	Software: Borrowing Enabled	
		Hardware: Borrowing Enabled	

- The Bill class can borrow unused bandwidth from the Sales USA class because the Bill class has bandwidth borrowing enabled.
- The Bill class can also borrow unused bandwidth from the Sales class because the Sales USA class also has bandwidth borrowing enabled.
- The Bill class cannot borrow unused bandwidth from the Root class because the Sales class has bandwidth borrowing disabled.
- The Amy class cannot borrow unused bandwidth from the Sales USA class because the Amy class has bandwidth borrowing disabled.
- The Research Software and Hardware classes can both borrow unused bandwidth from the Research class because the Research Software and Hardware classes both have bandwidth borrowing enabled.
- The Research Software and Hardware classes can also borrow unused bandwidth from the Root class because the Research class also has bandwidth borrowing enabled.

20.9.2 Maximize Bandwidth Usage With Bandwidth Borrowing

If you configure both maximize bandwidth usage (on the interface) and bandwidth borrowing (on individual sub-classes), the ZyWALL functions as follows.

- 1 The ZyWALL sends traffic according to each bandwidth class's bandwidth budget.

- 2 The ZyWALL assigns a parent class's unused bandwidth to its sub-classes that have more traffic than their budgets and have bandwidth borrowing enabled. The ZyWALL gives priority to sub-classes of higher priority and treats classes of the same priority equally.
- 3 The ZyWALL assigns any remaining unused or unbudgeted bandwidth on the interface to any class that requires it. The ZyWALL gives priority to classes of higher priority and treats classes of the same level equally.
- 4 If the bandwidth requirements of all of the traffic classes are met and there is still some unbudgeted bandwidth, the ZyWALL assigns it to traffic that does not match any of the classes.

20.10 Configuring Summary

Click **BW MGMT** to open the **Summary** screen.

Enable bandwidth management on an interface and set the maximum allowed bandwidth for that interface.

Figure 155 Bandwidth Management: Summary

Class	Active	Speed (kbps)	Scheduler	Maximize Bandwidth Usage
WAN1	<input checked="" type="checkbox"/>	100000	Priority-Based	<input checked="" type="checkbox"/>
WAN2	<input type="checkbox"/>	100000	Fairness-Based	<input type="checkbox"/>
LAN	<input type="checkbox"/>	100000	Fairness-Based	<input type="checkbox"/>
DMZ	<input type="checkbox"/>	100000	Fairness-Based	<input type="checkbox"/>

The following table describes the labels in this screen.

Table 114 Bandwidth Management: Summary

LABEL	DESCRIPTION
WAN1 WAN2 LAN DMZ	These read-only labels represent the physical interfaces. Select an interface's check box to enable bandwidth management on that interface. Bandwidth management applies to all traffic flowing out of the router through the interface, regardless of the traffic's source.
Active	Traffic redirect or IP alias may cause LAN-to-LAN or DMZ-to-DMZ traffic to pass through the ZyWALL and be managed by bandwidth management. Select an interface's check box to enable bandwidth management on that interface.

Table 114 Bandwidth Management: Summary (continued)

LABEL	DESCRIPTION
Speed (kbps)	Enter the amount of bandwidth for this interface that you want to allocate using bandwidth management. This appears as the bandwidth budget of the interface's root class (see Section 20.11 on page 332). The recommendation is to set this speed to match what the device connected to the port can handle. For example, set the WAN interface speed to 1000 kbps if the broadband device connected to the WAN port has an upstream speed of 1000 kbps.
Scheduler	Select either Priority-Based or Fairness-Based from the drop-down menu to control the traffic flow. Select Priority-Based to give preference to bandwidth classes with higher priorities. Select Fairness-Based to treat all bandwidth classes equally. See Section 20.7 on page 327 .
Maximize Bandwidth Usage	Select this check box to have the ZyWALL divide up all of the interface's unallocated and/or unused bandwidth among the bandwidth classes that require bandwidth. Do not select this if you want to reserve bandwidth for traffic that does not match a bandwidth class (see Section 20.8.1 on page 328) or you want to limit the speed of this interface (see the Speed field description).
Apply	Click Apply to save your changes back to the ZyWALL.
Reset	Click Reset to begin configuring this screen afresh.

20.11 Configuring Class Setup

The **Class Setup** screen displays the configured bandwidth classes by individual interface. Select an interface and click the buttons to perform the actions described next. Click “+” to expand the class tree or click “-” to collapse the class tree. Each interface has a permanent root class. The bandwidth budget of the root class is equal to the speed you configured on the interface (see [Section 20.10 on page 331](#) to configure the speed of the interface). Configure sub-class layers for the root class.

To add or delete child classes on an interface, click **BW MGMT**, then the **Class Setup** tab. The screen appears as shown (with example classes).

Figure 156 Bandwidth Management: Class Setup

BANDWIDTH MANAGEMENT

Summary **Class Setup** Monitor

Class Setup

Interface: WAN1

Bandwidth Management: Active

Root Class: 100000 kbps
 Administration: 15000 kbps
 COE: 5000 kbps
 CPE: 5000 kbps

Add Sub-Class Edit Delete Statistics

Filter List

#	Filter Name	Service	Destination IP Address	Destination Port	Source IP Address	Source Port	Protocol ID
1	Administration	FTP	0.0.0.0/0	0	192.168.1.0/24	0	0
2	COE	H.323	0.0.0.0/0	0	192.168.2.0/24	0	0
3	CPE	SIP	0.0.0.0/0	0	192.168.3.0/24	0	0

Move filter 0 to filter 0 (filter number).

The following table describes the labels in this screen.

Table 115 Bandwidth Management: Class Setup

LABEL	DESCRIPTION
Interface	Select an interface from the drop-down list box for which you wish to set up classes.
Bandwidth Management	This field displays whether bandwidth management on the interface you selected in the field above is enabled (Active) or not (Inactive).
Add Sub-Class	Click Add Sub-class to add a sub-class.
Edit	Click Edit to configure the selected class. You cannot edit the root class.
Delete	Click Delete to delete the class and all its sub-classes. You cannot delete the root class.
Statistics	Click Statistics to display the status of the selected class.
Filter List	This list displays the bandwidth management filters that are configured for the classes on the selected interface. The ZyWALL applies the bandwidth management filters in the order that they appear here. Once a connection matches a bandwidth management filter, the ZyWALL applies the rules of the corresponding bandwidth management class and does not check the connection against any other bandwidth management filters.
#	This is the index number of an individual bandwidth management filter.
Filter Name	This is the name that identifies a bandwidth management filter.
Service	This is the service that this bandwidth management filter is configured to manage.

Table 115 Bandwidth Management: Class Setup (continued)

LABEL	DESCRIPTION
Destination IP Address	This is the destination IP address for connections to which this bandwidth management filter applies.
Destination Port	This is the destination port for connections to which this bandwidth management filter applies.
Source IP Address	This is the source IP address for connections to which this bandwidth management filter applies.
Source Port	This is the source port for connections to which this bandwidth management filter applies.
Protocol ID	This is the protocol ID (service type) number for connections to which this bandwidth management filter applies. For example: 1 for ICMP, 6 for TCP or 17 for UDP.
Move	Type a filter's index number and the number for where you want to put that filter. Click Move to move the filter to the number that you typed. The ordering of your filters is important as they are applied in order of their numbering.

20.11.1 Bandwidth Manager Class Configuration

Configure a bandwidth management class in the **Class Setup** screen. You must use the **Summary** screen to enable bandwidth management on an interface before you can configure classes for that interface.

To add a child class, click **BW MGMT**, then the **Class Setup** tab. Click the **Add Sub-Class** button to open the following screen.

Figure 157 Bandwidth Management: Edit Class

BANDWIDTH MANAGEMENT - EDIT CLASS

Class Configuration

Class Name
Bandwidth Budget (Kbps)
Priority (0-7)
 Borrow bandwidth from parent class

Filter Configuration

Enable Bandwidth Filter
Service
Destination IP Address
Destination Subnet Mask
Destination Port
Source IP Address
Source Subnet Mask
Source Port
Protocol ID

The following table describes the labels in this screen.

Table 116 Bandwidth Management: Edit Class

LABEL	DESCRIPTION
Class Configuration	
Class Name	Use the auto-generated name or enter a descriptive name of up to 20 alphanumeric characters, including spaces.
Bandwidth Budget (kbps)	Specify the maximum bandwidth allowed for the class in kbps. The recommendation is a setting between 20 kbps and 20000 kbps for an individual class.
Priority	Enter a number between 0 and 7 to set the priority of this class. The higher the number, the higher the priority. The default setting is 3.
Borrow bandwidth from parent class	<p>Select this option to allow a sub-class to borrow bandwidth from its parent class if the parent class is not using up its bandwidth budget.</p> <p>Bandwidth borrowing is governed by the priority of the sub-classes. That is, a sub-class with the highest priority (7) is the first to borrow bandwidth from its parent class.</p> <p>Do not select this for the classes directly below the root class if you want to leave bandwidth available for other traffic types (see Section 20.8.1 on page 328) or you want to set the interface's speed to match what the next device in network can handle (see the Speed field description in Table 114 on page 331).</p>

Table 116 Bandwidth Management: Edit Class (continued)

LABEL	DESCRIPTION
Filter Configuration	
Enable Bandwidth Filter	<p>Select Enable Bandwidth Filter to have the ZyWALL use this bandwidth filter when it performs bandwidth management.</p> <p>You must enter a value in at least one of the following fields (other than the Subnet Mask fields which are only available when you enter the destination or source IP address).</p>
Service	<p>This field simplifies bandwidth class configuration by allowing you to select a predefined application. When you select a predefined application, you do not configure the rest of the bandwidth filter fields (other than enabling or disabling the filter).</p> <p>FTP (File Transfer Program) is a program to enable fast transfer of files, including large files that may not be possible by e-mail. Select FTP from the drop-down list box to configure the bandwidth filter for FTP traffic.</p> <p>H.323 is a protocol standard used for multimedia communications over networks, for example NetMeeting. Select H.323 from the drop-down list box to configure the bandwidth filter for H.323 traffic.</p> <p>SIP (Session Initiation Protocol) is a signaling protocol used in Internet telephony, instant messaging, events notification and conferencing. The ZyWALL supports SIP traffic pass-through. Select SIP from the drop-down list box to configure this bandwidth filter for SIP traffic. This option makes it easier to manage bandwidth for SIP traffic and is useful for example when there is a VoIP (Voice over Internet Protocol) device on your LAN.</p> <p>Note: If you select SIP, make sure you also use the <code>ip alg enable ALG_SIP</code> command to turn on the SIP ALG. See Appendix I on page 627 for more on the SIP ALG.</p> <p>Select Custom from the drop-down list box if you do not want to use a predefined application for the bandwidth class. When you select Custom, you need to configure at least one of the following fields (other than the Subnet Mask fields which you only enter if you also enter a corresponding destination or source IP address).</p>
Destination IP Address	Enter the destination IP address in dotted decimal notation.
Destination Subnet Mask	Enter the destination subnet mask. This field is N/A if you do not specify a Destination IP Address . Refer to Appendix D on page 595 for more information on IP subnetting.
Destination Port	Enter the port number of the destination. See Section 10.8 on page 194 for a table of services and port numbers.
Source IP Address	Enter the source IP address.
Source Subnet Mask	Enter the source subnet mask. This field is N/A if you do not specify a Source IP Address . Refer to Appendix D on page 595 for more information on IP subnetting.
Source Port	Enter the port number of the source. See the following table for some common services and port numbers.
Protocol ID	Enter the protocol ID (service type) number, for example: 1 for ICMP, 6 for TCP or 17 for UDP.

Table 116 Bandwidth Management: Edit Class (continued)

LABEL	DESCRIPTION
Apply	Click Apply to save your changes back to the ZyWALL.
Cancel	Click Cancel to exit this screen without saving.

Table 117 Services and Port Numbers

SERVICES	PORT NUMBER
ECHO	7
FTP (File Transfer Protocol)	21
SMTP (Simple Mail Transfer Protocol)	25
DNS (Domain Name System)	53
Finger	79
HTTP (Hyper Text Transfer protocol or WWW, Web)	80
POP3 (Post Office Protocol)	110
NNTP (Network News Transport Protocol)	119
SNMP (Simple Network Management Protocol)	161
SNMP trap	162
PPTP (Point-to-Point Tunneling Protocol)	1723

20.11.2 Bandwidth Management Statistics

Use the **Bandwidth Management Statistics** screen to view network performance information. Click the **Statistics** button in the **Class Setup** screen to open the **Statistics** screen.

Figure 158 Bandwidth Management: Statistics

Class Name: Root Class		Budget: 100000 (kbps)	
Tx Packets	Tx Bytes	Dropped Packets	Dropped Bytes
1147096	206423548	0	0

Bandwidth Statistics for the Past 8 Seconds							
t-8	t-7	t-6	t-5	t-4	t-3	t-2	t-1
1155	1391	1416	1208	1311	1312	1310	1296

Update Period (Seconds)

The following table describes the labels in this screen.

Table 118 Bandwidth Management: Statistics

LABEL	DESCRIPTION
Class Name	This field displays the name of the class the statistics page is showing.
Budget (kbps)	This field displays the amount of bandwidth allocated to the class.
Tx Packets	This field displays the total number of packets transmitted.
Tx Bytes	This field displays the total number of bytes transmitted.
Dropped Packets	This field displays the total number of packets dropped.
Dropped Bytes	This field displays the total number of bytes dropped.
Bandwidth Statistics for the Past 8 Seconds (t-8 to t-1)	
This field displays the bandwidth statistics (in bps) for the past one to eight seconds. For example, t-1 means one second ago.	
Update Period (Seconds)	Enter the time interval in seconds to define how often the information should be refreshed.
Set Interval	Click Set Interval to apply the new update period you entered in the Update Period field above.
Stop Update	Click Stop Update to stop the browser from refreshing bandwidth management statistics.
Clear Counter	Click Clear Counter to clear all of the bandwidth management statistics.

20.12 Configuring Monitor

To view the device's bandwidth usage and allotments, click **BW MGMT**, then the **Monitor** tab. The screen appears as shown.

Figure 159 Bandwidth Management: Monitor

BANDWIDTH MANAGEMENT

Summary Class Setup **Monitor**

Monitor

Interface: WAN2

Class	Budget (kbps)	Current Usage (kbps)
Root Class	100000	0
VoIP	15000	0
Web	10000	0
FTP	15000	0
Default Class	60000	0

Refresh

The following table describes the labels in this screen.

Table 119 Bandwidth Management: Monitor

LABEL	DESCRIPTION
Interface	Select an interface from the drop-down list box to view the bandwidth usage of its bandwidth classes.
Class	This field displays the name of the bandwidth class. A Default Class automatically displays for all the bandwidth in the Root Class that is not allocated to bandwidth classes. If you do not enable maximize bandwidth usage on an interface, the ZyWALL uses the bandwidth in this default class to send traffic that does not match any of the bandwidth classes. ^a
Budget (kbps)	This field displays the amount of bandwidth allocated to the bandwidth class.
Current Usage (kbps)	This field displays the amount of bandwidth that each bandwidth class is using.
Refresh	Click Refresh to update the page.

a. If you allocate all the root class's bandwidth to the bandwidth classes, the default class still displays a budget of 2 kbps (the minimum amount of bandwidth that can be assigned to a bandwidth class).

CHAPTER 21

DNS

This chapter shows you how to configure the DNS screens.

21.1 DNS Overview

DNS (Domain Name System) is for mapping a domain name to its corresponding IP address and vice versa. The DNS server is extremely important because without it, you must know the IP address of a machine before you can access it. The ZyWALL uses a system DNS server (in the order you specify in the **DNS System** screen) to resolve domain names, for example, VPN, DDNS and the time server.

21.2 DNS Server Address Assignment

The ZyWALL can get the DNS server addresses in the following ways.

- 1 The ISP tells you the DNS server addresses, usually in the form of an information sheet, when you sign up. If your ISP gives you DNS server addresses, manually enter them in the DNS server fields.
- 2 If your ISP dynamically assigns the DNS server IP addresses (along with the ZyWALL's WAN IP address), set the DNS server fields to get the DNS server address from the ISP.
- 3 You can manually enter the IP addresses of other DNS servers. These servers can be public or private. A DNS server could even be behind a remote IPsec router (see [Section 21.5.1 on page 342](#)).

21.3 DNS Servers

There are three places where you can configure DNS setup on the ZyWALL.

- 1 Use the **DNS System** screen to configure the ZyWALL to use a DNS server to resolve domain names for ZyWALL system features like VPN, DDNS and the time server.
- 2 Use the **DNS LAN** screen to configure the DNS server information that the ZyWALL sends to the DHCP client devices on the LAN.
- 3 Use the **REMOTE MGMT DNS** screen to configure the ZyWALL (in router mode) to accept or discard DNS queries.

21.4 Address Record

An address record contains the mapping of a fully qualified domain name (FQDN) to an IP address. An FQDN consists of a host and domain name and includes the top-level domain. For example, `www.zyxel.com.tw` is a fully qualified domain name, where “www” is the host, “zyxel” is the second-level domain, and “com.tw” is the top level domain. `mail.myZyXEL.com.tw` is also a FQDN, where "mail" is the host, "myZyXEL" is the second-level domain, and "com.tw" is the top level domain.

The ZyWALL allows you to configure address records about the ZyWALL itself or another device. This way you can keep a record of DNS names and addresses that people on your network may use frequently. If the ZyWALL receives a DNS query for an FQDN for which the ZyWALL has an address record, the ZyWALL can send the IP address in a DNS response without having to query a DNS name server.

21.4.1 DNS Wildcard

Enabling the wildcard feature for your host causes `*.yourhost.com` to be aliased to the same IP address as `yourhost.com`. This feature is useful if you want to be able to use, for example, `www.yourhost.com` and still reach your hostname.

21.5 Name Server Record

A name server record contains a DNS server's IP address. The ZyWALL can query the DNS server to resolve domain names for features like VPN, DDNS and the time server. A domain zone may also be included. A domain zone is a fully qualified domain name without the host. For example, `zyxel.com.tw` is the domain zone for the `www.zyxel.com.tw` fully qualified domain name.

21.5.1 Private DNS Server

In cases where you want to use domain names to access Intranet servers on a remote private network that has a DNS server, you must identify that DNS server. You cannot use DNS servers on the LAN or from the ISP since these DNS servers cannot resolve domain names to private IP addresses on the remote private network.

The following figure depicts an example where three VPN tunnels are created from ZyWALL A; one to branch office 2, one to branch office 3 and another to headquarters (HQ). In order to access computers that use private domain names on the HQ network, the ZyWALL at branch office 1 uses the Intranet DNS server in headquarters.

Figure 160 Private DNS Server Example

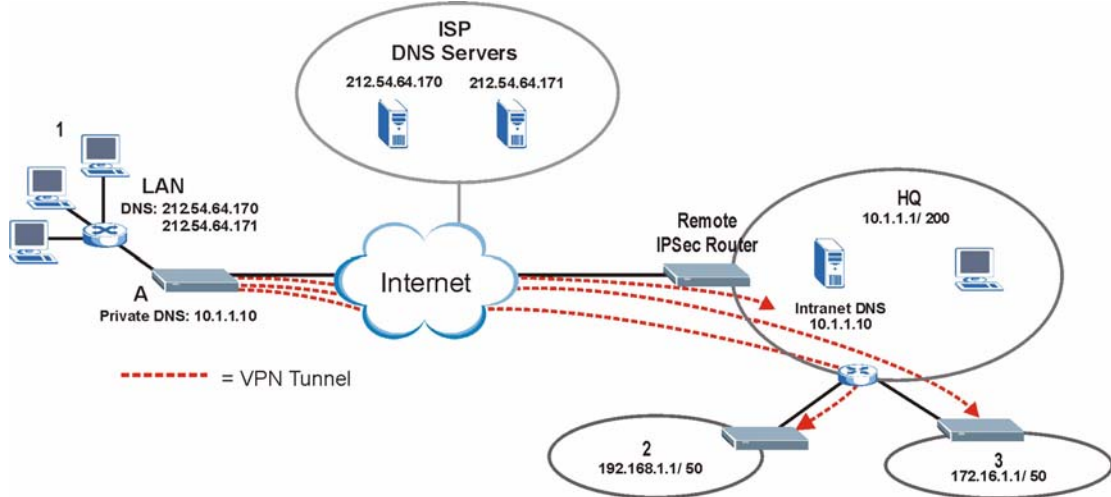

Note: If you do not specify an Intranet DNS server on the remote network, then the VPN host must use IP addresses to access the computers on the remote private network.

21.6 System Screen

To configure your ZyWALL's DNS address and name server records, click **DNS**. The screen appears as shown.

Figure 161 System DNS

DNS

System	Cache	LAN	DDNS	
Address Record				
#	FQDN	Wildcard	IP Address	Modify
1	www.zyxel.com.tw	Yes	0.0.0.0 (WAN_1)	
2	mail.zyxel.com.tw	No	172.21.3.200	
<input type="button" value="Add"/>				
Name Server Record				
#	Domain Zone	From	DNS Server	Modify
1	nctu/edu.tw	User-Defined	140.113.68.10	
-	*	Default	None	N/A
<input type="button" value="Insert"/> new record before record <input type="text" value="1"/> (record number).				

The following table describes the labels in this screen.

Table 120 System DNS

LABEL	DESCRIPTION
Address Record	An address record specifies the mapping of a fully qualified domain name (FQDN) to an IP address. An FQDN consists of a host and domain name and includes the top-level domain. For example, www.zyxel.com.tw is a fully qualified domain name, where "www" is the host, "zyxel" is the second-level domain, and "com.tw" is the top level domain.
#	This is the index number of the address record.
FQDN	This is a host's fully qualified domain name.
Wildcard	This column displays whether or not the DNS wildcard feature is enabled for this domain name.
IP Address	This is the IP address of a host.
Modify	Click the edit icon to go to the screen where you can edit the record. Click the delete icon to remove an existing record. A window display asking you to confirm that you want to delete the record. Note that subsequent records move up by one when you take this action.
Add	Click Add to open a screen where you can add a new address record. Refer to Table 121 on page 345 for information on the fields.
Name Server Record	A name server record contains a DNS server's IP address. The ZyWALL can query the DNS server to resolve domain names for features like VPN, DDNS and the time server. When the ZyWALL needs to resolve a domain name, it checks it against the name server record entries in the order that they appear in this list. A "*" indicates a name server record without a domain zone. The default record is grayed out. The ZyWALL uses this default record if the domain name that needs to be resolved does not match any of the other name server records.
#	This is the index number of the name server record.
Domain Zone	A domain zone is a fully qualified domain name without the host. For example, zyxel.com.tw is the domain zone for the www.zyxel.com.tw fully qualified domain name.
From	This field displays whether the IP address of a DNS server is from a WAN interface (and which it is) or specified by the user.
DNS Server	This is the IP address of a DNS server.
Modify	Click a triangle icon to move the record up or down in the list. Click the edit icon to go to the screen where you can edit the record. Click the delete icon to remove an existing record. A window display asking you to confirm that you want to delete the record. Note that subsequent records move up by one when you take this action.
Insert	Click Insert to open a screen where you can insert a new name server record. Refer to Table 122 on page 346 for information on the fields.

21.6.1 Adding an Address Record

Click **Add** in the **System** screen to add an address record.

Figure 162 System DNS: Add Address Record

The following table describes the labels in this screen.

Table 121 System DNS: Add Address Record

LABEL	DESCRIPTION
FQDN	Type a fully qualified domain name (FQDN) of a server. An FQDN starts with a host name and continues all the way up to the top-level domain name. For example, www.zyxel.com.tw is a fully qualified domain name, where “www” is the host, “zyxel” is the second-level domain, and “com.tw” is the top level domain.
IP Address	If this entry is for one of the WAN ports, select WAN Interface and select WAN 1 or WAN 2 from the drop-down list box. For entries that are not for one of the WAN ports, select Custom and enter the IP address of the host in dotted decimal notation.
Wildcard	Select the check box to enable DNS wildcard.
Apply	Click Apply to save your changes back to the ZyWALL.
Cancel	Click Cancel to exit this screen without saving.

21.6.2 Inserting a Name Server record

Click **Insert** in the **System** screen to insert a name server record.

Figure 163 System DNS: Insert Name Server Record

The following table describes the labels in this screen.

Table 122 System DNS: Insert Name Server Record

LABEL	DESCRIPTION
Domain Zone	<p>This field is optional.</p> <p>A domain zone is a fully qualified domain name without the host. For example, zyxel.com.tw is the domain zone for the www.zyxel.com.tw fully qualified domain name. For example, whenever the ZyWALL receives needs to resolve a zyxel.com.tw domain name, it can send a query to the recorded name server IP address.</p> <p>Leave this field blank if all domain zones are served by the specified DNS server(s).</p>
DNS Server	<p>Select the DNS Server(s) from ISP radio button if your ISP dynamically assigns DNS server information. The fields below display the (read-only) DNS server IP address(es) that the ISP assigns. N/A displays for any DNS server IP address fields for which the ISP does not assign an IP address. N/A displays for all of the DNS server IP address fields if the ZyWALL has a fixed WAN IP address.</p> <p>Select Public DNS Server if you have the IP address of a DNS server. The IP address must be public or a private address on your local LAN. Enter the DNS server's IP address in the field to the right.</p> <p>Public DNS Server entries with the IP address set to 0.0.0.0 are not allowed.</p> <p>Select Private DNS Server if the DNS server has a private IP address and is located behind a VPN peer. Enter the DNS server's IP address in the field to the right.</p> <p>With a private DNS server, you must also configure the first DNS server entry in the DNS LAN screen to use DNS Relay.</p> <p>You must also configure a VPN rule since the ZyWALL uses a VPN tunnel when it relays DNS queries to the private DNS server. The rule must include the LAN IP address of the ZyWALL as a local IP address and the IP address of the DNS server as a remote IP address.</p> <p>Private DNS Server entries with the IP address set to 0.0.0.0 are not allowed.</p>
Apply	Click Apply to save your changes back to the ZyWALL.
Cancel	Click Cancel to exit this screen without saving.

21.7 DNS Cache

DNS cache is the temporary storage area where a router stores responses from DNS servers. When the ZyWALL receives a positive or negative response for a DNS query, it records the response in the DNS cache. A positive response means that the ZyWALL received the IP address for a domain name that it checked with a DNS server within the five second DNS timeout period. A negative response means that the ZyWALL did not receive a response for a query it sent to a DNS server within the five second DNS timeout period.

When the ZyWALL receives DNS queries, it compares them against the DNS cache before querying a DNS server. If the DNS query matches a positive entry, the ZyWALL responds with the IP address from the entry. If the DNS query matches a negative entry, the ZyWALL replies that the DNS query failed.

21.8 Configure DNS Cache

To configure your ZyWALL's DNS caching, click **DNS**, then the **Cache** tab. The screen appears as shown.

Figure 164 DNS Cache

DNS

System Cache LAN DDNS

DNS Cache Setup

Cache Positive DNS Resolutions
Maximum TTL (60~3600 sec)

Cache Negative DNS Resolutions
Negative Cache Period (60~3600 sec)

DNS Cache Entry

#	Cache Type▲	Domain Name	IP Address	Remaining Time (sec)	Modify
1	Positive	www.zyxel.com	65.170.185.66	2902	
2	Positive	www.zyxel.com.tw	211.21.188.14	2880	
3	Positive	ntp3.cs.wisc.edu	128.105.37.11	1146	
4	Positive	www.google.com.tw	216.239.57.104	7	

The following table describes the labels in this screen.

Table 123 DNS Cache

LABEL	DESCRIPTION
DNS Cache Setup	
Cache Positive DNS Resolutions	Select the check box to record the positive DNS resolutions in the cache. Caching positive DNS resolutions helps speed up the ZyWALL's processing of commonly queried domain names and reduces the amount of traffic that the ZyWALL sends out to the WAN.
Maximum TTL	Type the maximum time to live (TTL) (60 to 3600 seconds). This sets how long the ZyWALL is to allow a positive resolution entry to remain in the DNS cache before discarding it.
Cache Negative DNS Resolutions	Caching negative DNS resolutions helps speed up the ZyWALL's processing of commonly queried domain names (for which DNS resolution has failed) and reduces the amount of traffic that the ZyWALL sends out to the WAN.
Negative Cache Period	Type the time (60 to 3600 seconds) that the ZyWALL is to allow a negative resolution entry to remain in the DNS cache before discarding it.
Apply	Click Apply to save your changes back to the ZyWALL.
Reset	Click Reset to begin configuring this screen afresh.
DNS Cache Entry	
Flush	Click this button to clear the cache manually. After you flush the cache, the ZyWALL must query the DNS servers again for any domain names that had been previously resolved.
Refresh	Click this button to reload the cache.
#	This is the index number of a record.
Cache Type	This displays whether the response for the DNS request is positive or negative.
Domain Name	This is the domain name of a host.
IP Address	This is the (resolved) IP address of a host. This field displays 0.0.0.0 for negative DNS resolution entries.
Remaining Time (sec)	This is the number of seconds left before the DNS resolution entry is discarded from the cache.
Modify	Click the delete icon to remove the DNS resolution entry from the cache.

21.9 Configuring DNS LAN

Click **DNS** and then the **LAN** tab to open the **DNS LAN** screen shown next. Use this screen to configure the DNS server information that the ZyWALL sends to its LAN DHCP clients.

Figure 165 DNS LAN

The following table describes the labels in this screen.

Table 124 DNS LAN

LABEL	DESCRIPTION
DNS Servers Assigned by DHCP Server	The ZyWALL passes a DNS (Domain Name System) server IP address (in the order you specify here) to the DHCP clients. The ZyWALL only passes this information to the LAN DHCP clients when you select the DHCP Server check box. When you clear the DHCP Server check box, DHCP service is disabled and you must have another DHCP sever on your LAN, or else the computers must have their DNS server addresses manually configured.
First DNS Server Second DNS Server Third DNS Server	<p>Select From ISP if your ISP dynamically assigns DNS server information (and the ZyWALL's WAN IP address). Use the drop-down list box to select a DNS server IP address that the ISP assigns in the field to the right.</p> <p>Select User-Defined if you have the IP address of a DNS server. Enter the DNS server's IP address in the field to the right. If you chose User-Defined, but leave the IP address set to 0.0.0.0, User-Defined changes to None after you click Apply. If you set a second choice to User-Defined, and enter the same IP address, the second User-Defined changes to None after you click Apply.</p> <p>Select DNS Relay to have the ZyWALL act as a DNS proxy. The ZyWALL's LAN IP address displays in the field to the right (read-only). The ZyWALL tells the DHCP clients on the LAN that the ZyWALL itself is the DNS server. When a computer on the LAN sends a DNS query to the ZyWALL, the ZyWALL forwards the query to the ZyWALL's system DNS server (configured in the DNS System screen) and relays the response back to the computer. You can only select DNS Relay for one of the three servers; if you select DNS Relay for a second or third DNS server, that choice changes to None after you click Apply.</p> <p>Select None if you do not want to configure DNS servers. If you do not configure a DNS server, you must know the IP address of a computer in order to access it.</p>
Apply	Click Apply to save your changes back to the ZyWALL.
Reset	Click Reset to begin configuring this screen afresh.

21.10 Dynamic DNS

Dynamic DNS allows you to update your current dynamic IP address with one or many dynamic DNS services so that anyone can contact you (in NetMeeting, CU-SeeMe, etc.). You can also access your FTP server or Web site on your own computer using a domain name (for instance myhost.dhs.org, where myhost is a name of your choice) that will never change instead of using an IP address that changes each time you reconnect. Your friends or relatives will always be able to call you even if they don't know your IP address.

First of all, you need to have registered a dynamic DNS account with www.dyndns.org. This is for people with a dynamic IP from their ISP or DHCP server that would still like to have a domain name. The Dynamic DNS service provider will give you a password or key.

Note: You must go to the Dynamic DNS service provider's website and register a user account and a domain name before you can use the Dynamic DNS service with your ZyWALL.

21.10.1 DYNDNS Wildcard

Enabling the wildcard feature for your host causes *.yourhost.dyndns.org to be aliased to the same IP address as yourhost.dyndns.org. This feature is useful if you want to be able to use, for example, www.yourhost.dyndns.org and still reach your hostname.

Note: If you have a private WAN IP address, then you cannot use Dynamic DNS.

21.10.2 High Availability

A DNS server maps a domain name to a port's IP address. If that WAN port loses its connection, high availability allows the router to substitute another port's IP address for the domain name mapping.

21.11 Configuring Dynamic DNS

To change your ZyWALL's DDNS, click **DNS**, then the **DDNS** tab. The screen appears as shown.

Figure 166 DDNS

DNS

System Cache LAN **DDNS**

Account Setup

Active

Service Provider WWW.DynDNS.ORG

Username

Password

My Domain Names

#	Domain Name	DDNS Type	Offline	Wildcard	WAN Interface	IP Address Update Policy	HA*
1	ZyWALL 70	Dynamic	<input type="checkbox"/>	<input checked="" type="checkbox"/>	WAN 1	Use WAN IP Address	<input checked="" type="checkbox"/>
2	ZyWALL_70	Dynamic	<input type="checkbox"/>	<input checked="" type="checkbox"/>	WAN 2	Let DDNS Server Auto Detect	<input checked="" type="checkbox"/>
3	<input type="text"/>	Dynamic	<input type="checkbox"/>	<input type="checkbox"/>	WAN 1	Use User-Defined 0 . 0 . 0 . 0	<input type="checkbox"/>
4	<input type="text"/>	Dynamic	<input type="checkbox"/>	<input type="checkbox"/>	WAN 1	Use WAN IP Address	<input type="checkbox"/>
5	<input type="text"/>	Dynamic	<input type="checkbox"/>	<input type="checkbox"/>	WAN 1	Use WAN IP Address	<input type="checkbox"/>

*HA: High Availability. Enable this option to bind with another WAN interface when the specified WAN interface is not available.

Apply Reset

The following table describes the labels in this screen.

Table 125 DDNS

LABEL	DESCRIPTION
Account Setup	
Active	Select this check box to use dynamic DNS.
Service Provider	This is the name of your Dynamic DNS service provider.
Username	Enter your user name. You can use up to 31 alphanumeric characters (and the underscore). Spaces are not allowed.
Password	Enter the password associated with the user name above. You can use up to 31 alphanumeric characters (and the underscore). Spaces are not allowed.
My Domain Names	
Domain Name 1~5	Enter the host names in these fields.
DDNS Type	Select the type of service that you are registered for from your Dynamic DNS service provider. Select Dynamic if you have the Dynamic DNS service. Select Static if you have the Static DNS service. Select Custom if you have the Custom DNS service.
Offline	This option is available when Custom is selected in the DDNS Type field. Check with your Dynamic DNS service provider to have traffic redirected to a URL (that you can specify) while you are off line.
Wildcard	Select the check box to enable DYNDNS Wildcard.
WAN Interface	Select the WAN port to use for updating the IP address of the domain name.

Table 125 DDNS

LABEL	DESCRIPTION
IP Address Update Policy	<p>Select Use WAN IP Address to have the ZyWALL update the domain name with the WAN port's IP address.</p> <p>Select Use User-Defined and enter the IP address if you have a static IP address.</p> <p>Select Let DDNS Server Auto Detect only when there are one or more NAT routers between the ZyWALL and the DDNS server. This feature has the DDNS server automatically detect and use the IP address of the NAT router that has a public IP address.</p> <p>Note: The DDNS server may not be able to detect the proper IP address if there is an HTTP proxy server between the ZyWALL and the DDNS server.</p>
HA	<p>Select this check box to enable the high availability (HA) feature. High availability has the ZyWALL update a domain name with another port's IP address when the normal WAN port does not have a connection.</p> <p>If the WAN port specified in the WAN Interface field does not have a connection, the ZyWALL will attempt to use the IP address of another WAN port to update the domain name.</p> <p>When the WAN ports are in the active/passive operating mode, the ZyWALL will update the domain name with the IP address of whichever WAN port has a connection, regardless of the setting in the WAN Interface field.</p> <p>Disable this feature and the ZyWALL will only update the domain name with an IP address of the WAN port specified in the WAN Interface field. If that WAN port does not have a connection, the ZyWALL will not update the domain name with another port's IP address.</p> <p>Note: If you enable high availability, DDNS can also function when the ZyWALL uses the dial backup port. DDNS does not function when the ZyWALL uses traffic redirect.</p>
Apply	Click Apply to save your changes back to the ZyWALL.
Reset	Click Reset to begin configuring this screen afresh.

CHAPTER 22

Remote Management

This chapter provides information on the Remote Management screens.

22.1 Remote Management Overview

Remote management allows you to determine which services/protocols can access which ZyWALL interface (if any) from which computers.

Note: When you configure remote management to allow management from the WAN, you still need to configure a firewall rule to allow access. See [Chapter 10 on page 179](#) for details on configuring firewall rules.

You may manage your ZyWALL from a remote location via:

- Internet (WAN only)
- LAN only,
- Neither (Disable).
- ALL (LAN&WAN&DMZ)
- DMZ only,

Note: When you choose **WAN only** or **ALL** (LAN & WAN& DMZ), you still need to configure a firewall rule to allow access.

To disable remote management of a service, select **Disable** in the corresponding **Server Access** field.

You may only have one remote management session running at a time. The ZyWALL automatically disconnects a remote management session of lower priority when another remote management session of higher priority starts. The priorities for the different types of remote management sessions are as follows.

- 1 Console port
- 2 SSH
- 3 Telnet
- 4 HTTPS and HTTP

22.1.1 Remote Management Limitations

- 1 Remote management over LAN or WAN will not work when:

- 2 A filter in SMT menu 3.1 (LAN) or in menu 11.5 (WAN) is applied to block a Telnet, FTP or Web service.
- 3 You have disabled that service in one of the remote management screens.
- 4 The IP address in the **Secure Client IP Address** field does not match the client IP address. If it does not match, the ZyWALL will disconnect the session immediately.
- 5 There is already another remote management session with an equal or higher priority running. You may only have one remote management session running at one time.
- 6 There is a firewall rule that blocks it.

22.1.2 Remote Management and NAT

When NAT is enabled:

- Use the ZyWALL's WAN IP address when configuring from the WAN.
- Use the ZyWALL's LAN IP address when configuring from the LAN.

22.1.3 System Timeout

There is a default system management idle timeout of five minutes (three hundred seconds). The ZyWALL automatically logs you out if the management session remains idle for longer than this timeout period. The management session does not time out when a statistics screen is polling. You can change the timeout period in the **System** screen.

22.2 Introduction to HTTPS

HTTPS (HyperText Transfer Protocol over Secure Socket Layer, or HTTP over SSL) is a web protocol that encrypts and decrypts web pages. Secure Socket Layer (SSL) is an application-level protocol that enables secure transactions of data by ensuring confidentiality (an unauthorized party cannot read the transferred data), authentication (one party can identify the other party) and data integrity (you know if data has been changed).

It relies upon certificates, public keys, and private keys (see [Chapter 15 on page 267](#) for more information).

HTTPS on the ZyWALL is used so that you may securely access the ZyWALL using the web configurator. The SSL protocol specifies that the SSL server (the ZyWALL) must always authenticate itself to the SSL client (the computer which requests the HTTPS connection with the ZyWALL), whereas the SSL client only should authenticate itself when the SSL server requires it to do so (select **Authenticate Client Certificates** in the **REMOTE MGMT, WWW** screen). **Authenticate Client Certificates** is optional and if selected means the SSL-client must send the ZyWALL a certificate. You must apply for a certificate for the browser from a CA that is a trusted CA on the ZyWALL.

Please refer to the following figure.

- 1 HTTPS connection requests from an SSL-aware web browser go to port 443 (by default) on the ZyWALL's WS (web server).
- 2 HTTP connection requests from a web browser go to port 80 (by default) on the ZyWALL's WS (web server).

Figure 167 HTTPS Implementation

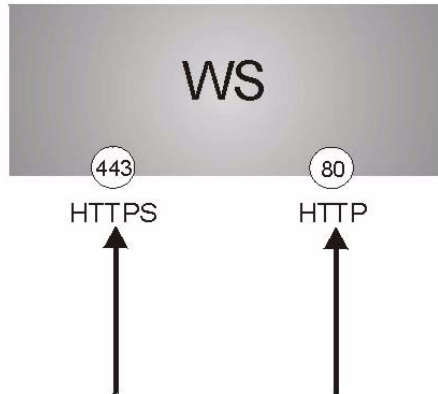

Note: If you disable **HTTP Server Access (Disable)** in the **REMOTE MGMT WWW** screen, then the ZyWALL blocks all HTTP connection attempts.

22.3 Configuring WWW

To change your ZyWALL's web settings, click **REMOTE MGMT** to open the **WWW** screen.

Figure 168 WWW

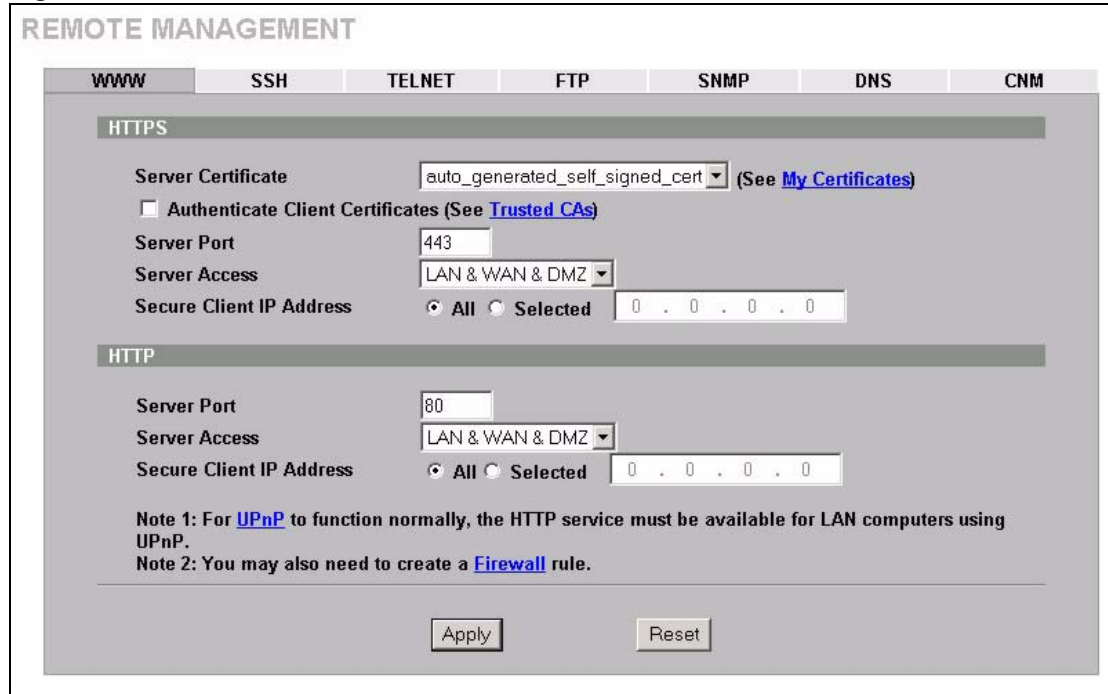

The following table describes the labels in this screen.

Table 126 WWW

LABEL	DESCRIPTION
HTTPS	
Server Certificate	Select the Server Certificate that the ZyWALL will use to identify itself. The ZyWALL is the SSL server and must always authenticate itself to the SSL client (the computer which requests the HTTPS connection with the ZyWALL).
Authenticate Client Certificates	Select Authenticate Client Certificates (optional) to require the SSL client to authenticate itself to the ZyWALL by sending the ZyWALL a certificate. To do that the SSL client must have a CA-signed certificate from a CA that has been imported as a trusted CA on the ZyWALL (see Appendix K on page 645 on importing certificates for details).
Server Port	The HTTPS proxy server listens on port 443 by default. If you change the HTTPS proxy server port to a different number on the ZyWALL, for example 8443, then you must notify people who need to access the ZyWALL web configurator to use "https://ZyWALL IP Address: 8443 " as the URL.
Server Access	Select a ZyWALL interface from Server Access on which incoming HTTPS access is allowed. You can allow only secure web configurator access by setting the HTTP Server Access field to Disable and setting the HTTPS Server Access field to an interface(s).
Secure Client IP Address	A secure client is a "trusted" computer that is allowed to communicate with the ZyWALL using this service. Select All to allow any computer to access the ZyWALL using this service. Choose Selected to just allow the computer with the IP address that you specify to access the ZyWALL using this service.
HTTP	

Table 126 WWW (continued)

LABEL	DESCRIPTION
Server Port	You may change the server port number for a service if needed, however you must use the same port number in order to use that service for remote management.
Server Access	Select the interface(s) through which a computer may access the ZyWALL using this service.
Secure Client IP Address	A secure client is a "trusted" computer that is allowed to communicate with the ZyWALL using this service. Select All to allow any computer to access the ZyWALL using this service. Choose Selected to just allow the computer with the IP address that you specify to access the ZyWALL using this service.
Apply	Click Apply to save your customized settings and exit this screen.
Reset	Click Reset to begin configuring this screen afresh.

22.4 HTTPS Example

If you haven't changed the default HTTPS port on the ZyWALL, then in your browser enter "https://ZyWALL IP Address/" as the web site address where "ZyWALL IP Address" is the IP address or domain name of the ZyWALL you wish to access.

22.4.1 Internet Explorer Warning Messages

When you attempt to access the ZyWALL HTTPS server, a Windows dialog box pops up asking if you trust the server certificate. Click **View Certificate** if you want to verify that the certificate is from the ZyWALL.

You see the following **Security Alert** screen in Internet Explorer. Select **Yes** to proceed to the web configurator login screen; if you select **No**, then web configurator access is blocked.

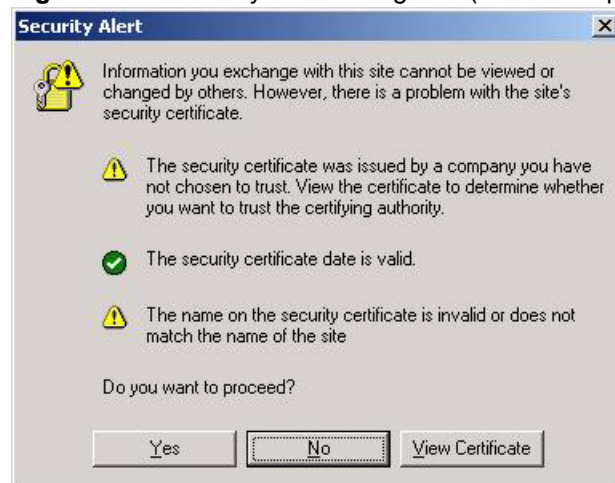
Figure 169 Security Alert Dialog Box (Internet Explorer)

22.4.2 Netscape Navigator Warning Messages

When you attempt to access the ZyWALL HTTPS server, a **Website Certified by an Unknown Authority** screen pops up asking if you trust the server certificate. Click **Examine Certificate** if you want to verify that the certificate is from the ZyWALL.

If **Accept this certificate temporarily for this session** is selected, then click **OK** to continue in Netscape.

Select **Accept this certificate permanently** to import the ZyWALL's certificate into the SSL client.

Figure 170 Security Certificate 1 (Netscape)

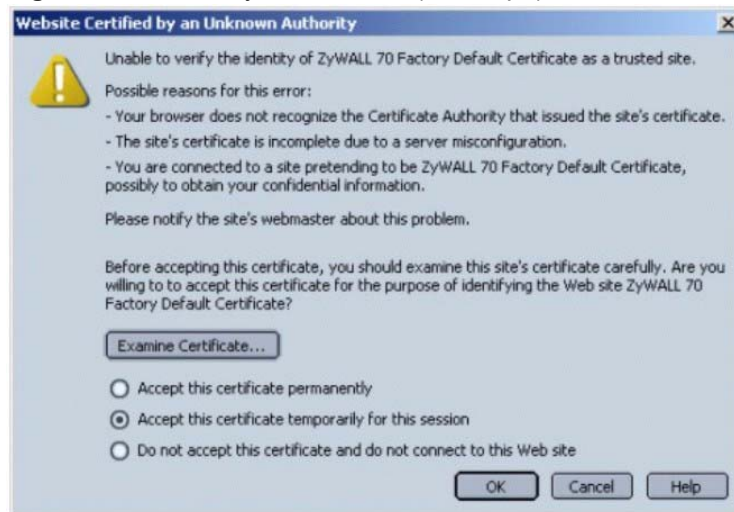

Figure 171 Security Certificate 2 (Netscape)



22.4.3 Avoiding the Browser Warning Messages

The following describes the main reasons that your browser displays warnings about the ZyWALL's HTTPS server certificate and what you can do to avoid seeing the warnings.

- The issuing certificate authority of the ZyWALL's HTTPS server certificate is not one of the browser's trusted certificate authorities. The issuing certificate authority of the ZyWALL's factory default certificate is the ZyWALL itself since the certificate is a self-signed certificate.
 - For the browser to trust a self-signed certificate, import the self-signed certificate into your operating system as a trusted certificate.
 - To have the browser trust the certificates issued by a certificate authority, import the certificate authority's certificate into your operating system as a trusted certificate. Refer to [Appendix K on page 645](#) for details.
- The actual IP address of the HTTPS server (the IP address of the ZyWALL's port that you are trying to access) does not match the common name specified in the ZyWALL's HTTPS server certificate that your browser received. Do the following to check the common name specified in the certificate that your ZyWALL sends to HTTPS clients.
 - a Click **REMOTE MGMT**. Write down the name of the certificate displayed in the **Server Certificate** field.
 - b Click **CERTIFICATES**. Find the certificate and check its **Subject** column. CN stands for certificate's common name (see [Figure 175 on page 361](#) for an example).

Use this procedure to have the ZyWALL use a certificate with a common name that matches the ZyWALL's actual IP address. You cannot use this procedure if you need to access the WAN port and it uses a dynamically assigned IP address.

- a Create a new certificate for the ZyWALL that uses the IP address (of the ZyWALL's port that you are trying to access) as the certificate's common name. For example, to use HTTPS to access a LAN port with IP address 192.168.1.1, create a certificate that uses 192.168.1.1 as the common name.
- b Go to the remote management **WWW** screen and select the newly created certificate in the **Server Certificate** field. Click **Apply**.

22.4.4 Login Screen

After you accept the certificate, the ZyWALL login screen appears. The lock displayed in the bottom right of the browser status bar denotes a secure connection.

Figure 172 Login Screen (Internet Explorer)



Figure 173 Login Screen (Netscape)



Click **Login** and you then see the next screen.

The factory default certificate is a common default certificate for all ZyWALL models.

Figure 174 Replace Certificate



Click **Apply** in the **Replace Certificate** screen to create a certificate using your ZyWALL's MAC address that will be specific to this device. Click **CERTIFICATES** to open the **My Certificates** screen. You will see information similar to that shown in the following figure.

Figure 175 Device-specific Certificate



CERTIFICATES

My Certificates Trusted CAs Trusted Remote Hosts Directory Servers

PKI Storage Space in Use

0% 3% 100%

My Certificates

#	Name	Type	Subject	Issuer	Valid From	Valid To	Modify
1	auto_generated_self_signed_cert	*SELF	CN=ZyWALL 70 00A0C5012345	CN=ZyWALL 70 00A0C5012345	2000 Jan 1st, 00:00:00 GMT	2030 Jan 1st, 00:00:00 GMT	 

Import Create Refresh

Click **Ignore** in the **Replace Certificate** screen to use the common ZyWALL certificate. You will then see this information in the **My Certificates** screen.

Figure 176 Common ZyWALL Certificate

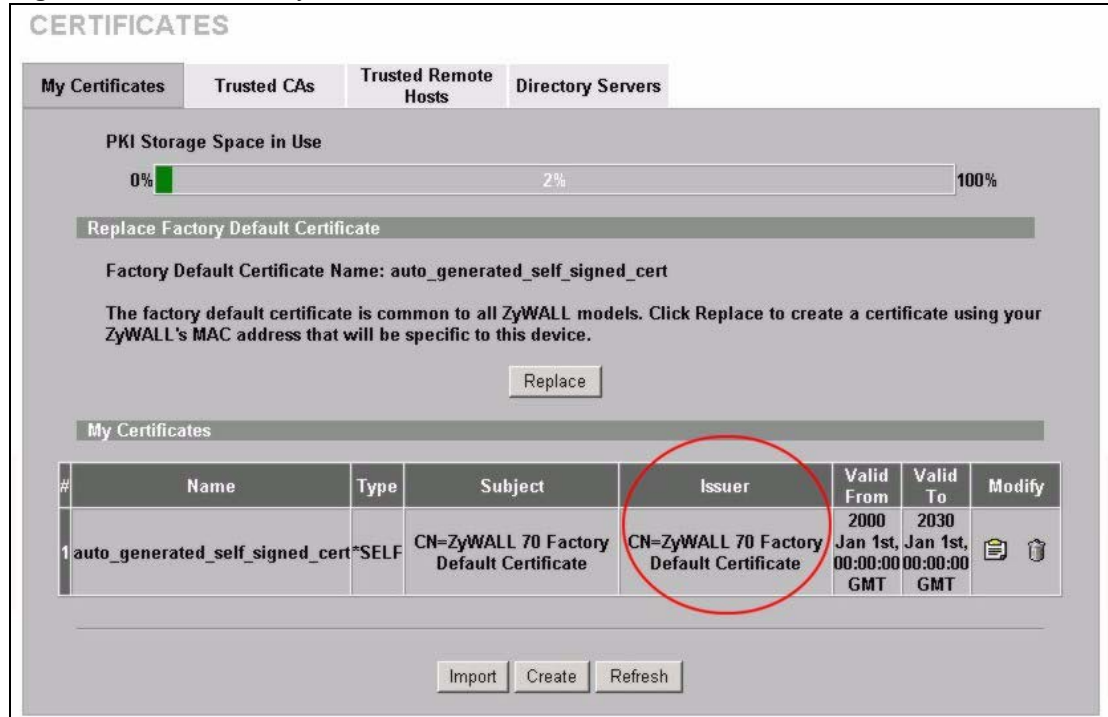

22.5 SSH Overview

Unlike Telnet or FTP, which transmit data in clear text, SSH (Secure Shell) is a secure communication protocol that combines authentication and data encryption to provide secure encrypted communication

between two hosts over an unsecured network.

Figure 177 SSH Communication Example



22.6 How SSH works

The following table summarizes how a secure connection is established between two remote hosts.

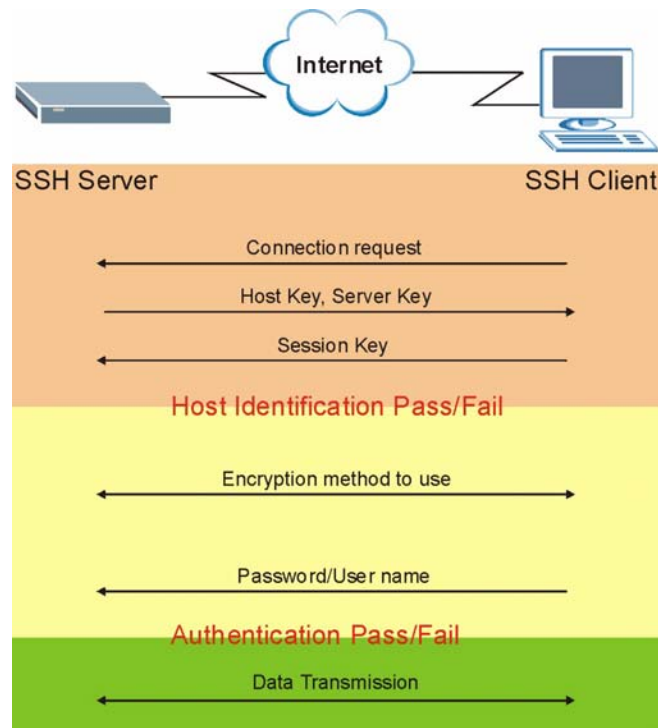
Figure 178 How SSH Works**1 Host Identification**

The SSH client sends a connection request to the SSH server. The server identifies itself with a host key. The client encrypts a randomly generated session key with the host key and server key and sends the result back to the server.

The client automatically saves any new server public keys. In subsequent connections, the server public key is checked against the saved version on the client computer.

2 Encryption Method

Once the identification is verified, both the client and server must agree on the type of encryption method to use.

3 Authentication and Data Transmission

After the identification is verified and data encryption activated, a secure tunnel is established between the client and the server. The client then sends its authentication information (user name and password) to the server to log in to the server.

22.7 SSH Implementation on the ZyWALL

Your ZyWALL supports SSH version 1.5 using RSA authentication and three encryption methods (DES, 3DES and Blowfish). The SSH server is implemented on the ZyWALL for remote SMT management and file transfer on port 22. Only one SSH connection is allowed at a time.

22.7.1 Requirements for Using SSH

You must install an SSH client program on a client computer (Windows or Linux operating system) that is used to connect to the ZyWALL over SSH.

22.8 Configuring SSH

To change your ZyWALL's Secure Shell settings, click **REMOTE MGMT**, then the **SSH** tab. The screen appears as shown.

Figure 179 SSH

The following table describes the labels in this screen.

Table 127 SSH

LABEL	DESCRIPTION
Server Host Key	Select the certificate whose corresponding private key is to be used to identify the ZyWALL for SSH connections. You must have certificates already configured in the My Certificates screen (Click My Certificates and see Chapter 15 on page 267 for details).
Server Port	You may change the server port number for a service if needed, however you must use the same port number in order to use that service for remote management.
Server Access	Select the interface(s) through which a computer may access the ZyWALL using this service.
Secure Client IP Address	A secure client is a “trusted” computer that is allowed to communicate with the ZyWALL using this service. Select All to allow any computer to access the ZyWALL using this service. Choose Selected to just allow the computer with the IP address that you specify to access the ZyWALL using this service.
Apply	Click Apply to save your customized settings and exit this screen.
Reset	Click Reset to begin configuring this screen afresh.

Note: It is recommended that you disable Telnet and FTP when you configure SSH for secure connections.

22.9 Secure Telnet Using SSH Examples

This section shows two examples using a command interface and a graphical interface SSH client program to remotely access the ZyWALL. The configuration and connection steps are similar for most SSH client programs. Refer to your SSH client program user's guide.

22.9.1 Example 1: Microsoft Windows

This section describes how to access the ZyWALL using the Secure Shell Client program.

- 1 Launch the SSH client and specify the connection information (IP address, port number or device name) for the ZyWALL.
- 2 Configure the SSH client to accept connection using SSH version 1.
- 3 A window displays prompting you to store the host key in you computer. Click **Yes** to continue.

Figure 180 SSH Example 1: Store Host Key



Enter the password to log in to the ZyWALL. The SMT main menu displays next.

22.9.2 Example 2: Linux

This section describes how to access the ZyWALL using the OpenSSH client program that comes with most Linux distributions.

- 1 Test whether the SSH service is available on the ZyWALL.

Enter `telnet 192.168.1.1 22` at a terminal prompt and press [ENTER]. The computer attempts to connect to port 22 on the ZyWALL (using the default IP address of 192.168.1.1).

A message displays indicating the SSH protocol version supported by the ZyWALL.

Figure 181 SSH Example 2: Test

```
$ telnet 192.168.1.1 22
Trying 192.168.1.1...
Connected to 192.168.1.1.
Escape character is '^]'.
SSH-1.5-1.0.0
```

- 2 Enter “ssh -1 192.168.1.1”. This command forces your computer to connect to the ZyWALL using SSH version 1. If this is the first time you are connecting to the ZyWALL using SSH, a message displays prompting you to save the host information of the ZyWALL. Type “yes” and press [ENTER].

Then enter the password to log in to the ZyWALL.

Figure 182 SSH Example 2: Log in

```
$ ssh -1 192.168.1.1
The authenticity of host '192.168.1.1 (192.168.1.1)' can't be
established.
RSA1 key fingerprint is
21:6c:07:25:7e:f4:75:80:ec:af:bd:d4:3d:80:53:d1.
Are you sure you want to continue connecting (yes/no)? yes
Warning: Permanently added '192.168.1.1' (RSA1) to the list of
known hosts.
Administrator@192.168.1.1's password:
```

- 3 The SMT main menu displays next.

22.10 Secure FTP Using SSH Example

This section shows an example on file transfer using the OpenSSH client program. The configuration and connection steps are similar for other SSH client programs. Refer to your SSH client program user's guide.

- 1 Enter “sftp -1 192.168.1.1”. This command forces your computer to connect to the ZyWALL for secure file transfer using SSH version 1. If this is the first time you are connecting to the ZyWALL using SSH, a message displays prompting you to save the host information of the ZyWALL. Type “yes” and press [ENTER].
- 2 Enter the password to login to the ZyWALL.
- 3 Use the “put” command to upload a new firmware to the ZyWALL.

Figure 183 Secure FTP: Firmware Upload Example

```

$ sftp -l 192.168.1.1
Connecting to 192.168.1.1...
The authenticity of host '192.168.1.1 (192.168.1.1)' can't be
established.
RSA1 key fingerprint is
21:6c:07:25:7e:f4:75:80:ec:af:bd:d4:3d:80:53:d1.
Are you sure you want to continue connecting (yes/no)? yes
Warning: Permanently added '192.168.1.1' (RSA1) to the list of
known hosts.
Administrator@192.168.1.1's password:
sftp> put firmware.bin ras
Uploading firmware.bin to /ras
Read from remote host 192.168.1.1: Connection reset by peer
Connection closed
$

```

22.11 Telnet

You can configure your ZyWALL for remote Telnet access as shown next.

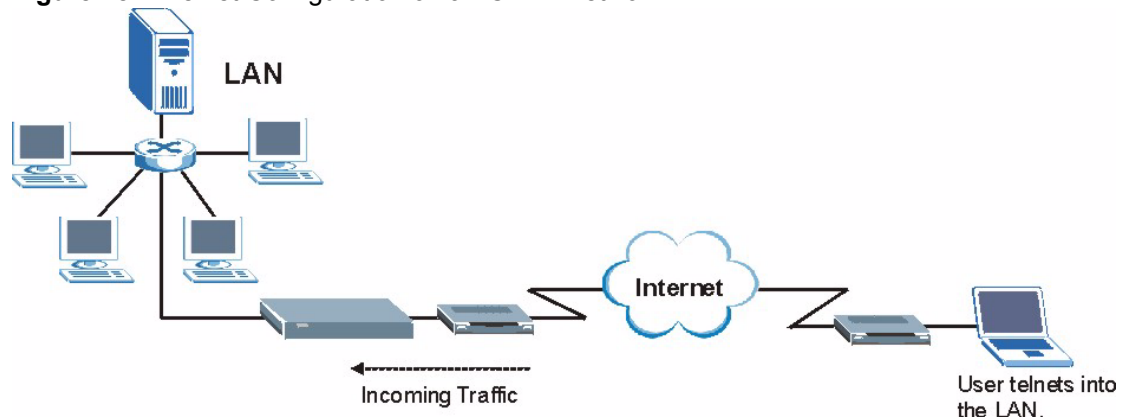
Figure 184 Telnet Configuration on a TCP/IP Network

22.12 Configuring TELNET

Click **REMOTE MGMT**, then the **TELNET** tab. The screen appears as shown.

Figure 185 Telnet



The following table describes the labels in this screen.

Table 128 Telnet

LABEL	DESCRIPTION
Server Port	You may change the server port number for a service if needed, however you must use the same port number in order to use that service for remote management.
Server Access	Select the interface(s) through which a computer may access the ZyWALL using this service.
Secure Client IP Address	A secure client is a “trusted” computer that is allowed to communicate with the ZyWALL using this service. Select All to allow any computer to access the ZyWALL using this service. Choose Selected to just allow the computer with the IP address that you specify to access the ZyWALL using this service.
Apply	Click Apply to save your customized settings and exit this screen.
Reset	Click Reset to begin configuring this screen afresh.

22.13 Configuring FTP

You can upload and download the ZyWALL’s firmware and configuration files using FTP, please see the chapter on firmware and configuration file maintenance for details. To use this feature, your computer must have an FTP client.

To change your ZyWALL’s FTP settings, click **REMOTE MGMT**, then the **FTP** tab. The screen appears as shown.

Figure 186 FTP

REMOTE MANAGEMENT

WWW SSH TELNET **FTP** SNMP DNS CNM

FTP

Server Port: 21

Server Access: LAN & WAN & DMZ

Secure Client IP Address: All Selected 0 . 0 . 0 . 0

Note: You may also need to create a [Firewall](#) rule.

Apply Reset

The following table describes the labels in this screen.

Table 129 FTP

LABEL	DESCRIPTION
Server Port	You may change the server port number for a service if needed, however you must use the same port number in order to use that service for remote management.
Server Access	Select the interface(s) through which a computer may access the ZyWALL using this service.
Secure Client IP Address	A secure client is a “trusted” computer that is allowed to communicate with the ZyWALL using this service. Select All to allow any computer to access the ZyWALL using this service. Choose Selected to just allow the computer with the IP address that you specify to access the ZyWALL using this service.
Apply	Click Apply to save your customized settings.
Reset	Click Reset to begin configuring this screen afresh.

22.14 Configuring SNMP

Simple Network Management Protocol is a protocol used for exchanging management information between network devices. SNMP is a member of the TCP/IP protocol suite. Your ZyWALL supports SNMP agent functionality, which allows a manager station to manage and monitor the ZyWALL through the network. The ZyWALL supports SNMP version one (SNMPv1). The next figure illustrates an SNMP management operation. SNMP is only available if TCP/IP is configured.

Note: SNMP is only available if TCP/IP is configured.

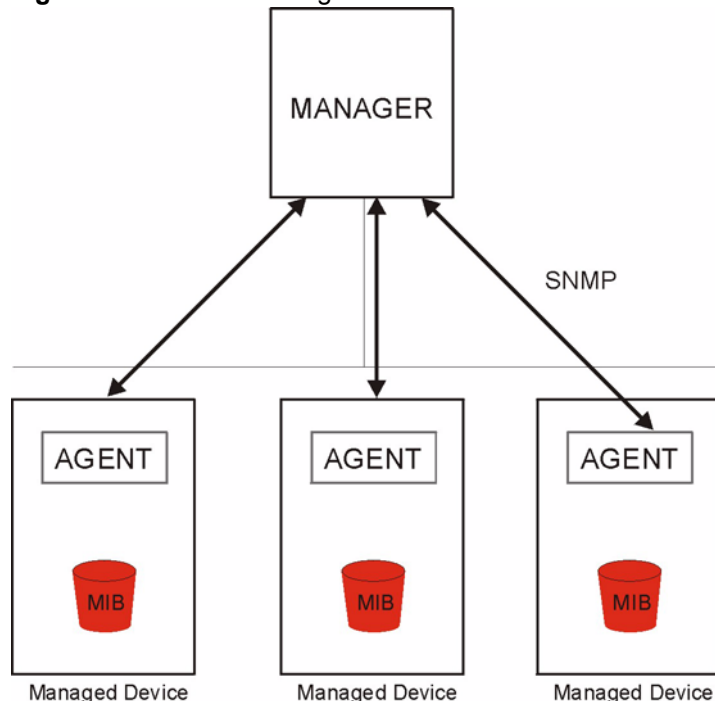
Figure 187 SNMP Management Model

An SNMP managed network consists of two main types of component: agents and a manager.

An agent is a management software module that resides in a managed device (the ZyWALL). An agent translates the local management information from the managed device into a form compatible with SNMP. The manager is the console through which network administrators perform network management functions. It executes applications that control and monitor managed devices.

The managed devices contain object variables/managed objects that define each piece of information to be collected about a device. Examples of variables include such as number of packets received, node port status etc. A Management Information Base (MIB) is a collection of managed objects. SNMP allows a manager and agents to communicate for the purpose of accessing these objects.

SNMP itself is a simple request/response protocol based on the manager/agent model. The manager issues a request and the agent returns responses using the following protocol operations:

- Get - Allows the manager to retrieve an object variable from the agent.
- GetNext - Allows the manager to retrieve the next object variable from a table or list within an agent. In SNMPv1, when a manager wants to retrieve all elements of a table from an agent, it initiates a Get operation, followed by a series of GetNext operations.
- Set - Allows the manager to set values for object variables within an agent.
- Trap - Used by the agent to inform the manager of some events.

22.14.1 Supported MIBs

The ZyWALL supports MIB II that is defined in RFC-1213 and RFC-1215. The focus of the MIBs is to let administrators collect statistical data and monitor status and performance.

22.14.2 SNMP Traps

The ZyWALL will send traps to the SNMP manager when any one of the following events occurs:

Table 130 SNMP Traps

TRAP #	TRAP NAME	DESCRIPTION
0	coldStart (defined in <i>RFC-1215</i>)	A trap is sent after booting (power on).
1	warmStart (defined in <i>RFC-1215</i>)	A trap is sent after booting (software reboot).
4	authenticationFailure (defined in <i>RFC-1215</i>)	A trap is sent to the manager when receiving any SNMP get or set requirements with the wrong community (password).
6	whyReboot (defined in ZYXEL-MIB)	A trap is sent with the reason of restart before rebooting when the system is going to restart (warm start).
6a	For intentional reboot :	A trap is sent with the message "System reboot by user!" if reboot is done intentionally, (for example, download new files, CLI command "sys reboot", etc.).
6b	For fatal error :	A trap is sent with the message of the fatal code if the system reboots because of fatal errors.

22.14.3 REMOTE MANAGEMENT: SNMP

To change your ZyWALL's SNMP settings, click **REMOTE MGMT**, then the **SNMP** tab. The screen appears as shown.

Figure 188 SNMP

The following table describes the labels in this screen.

Table 131 SNMP

LABEL	DESCRIPTION
SNMP Configuration	
Get Community	Enter the Get Community , which is the password for the incoming Get and GetNext requests from the management station. The default is public and allows all requests.
Set Community	Enter the Set community , which is the password for incoming Set requests from the management station. The default is public and allows all requests.
Trap	
Community	Type the trap community, which is the password sent with each trap to the SNMP manager. The default is public and allows all requests.
Destination	Type the IP address of the station to send your SNMP traps to.
SNMP	
Service Port	You may change the server port number for a service if needed, however you must use the same port number in order to use that service for remote management.
Service Access	Select the interface(s) through which a computer may access the ZyWALL using this service.
Secure Client IP Address	A secure client is a “trusted” computer that is allowed to communicate with the ZyWALL using this service. Select All to allow any computer to access the ZyWALL using this service. Choose Selected to just allow the computer with the IP address that you specify to access the ZyWALL using this service.
Apply	Click Apply to save your customized settings.
Reset	Click Reset to begin configuring this screen afresh.

22.15 Configuring DNS

Use DNS (Domain Name System) to map a domain name to its corresponding IP address and vice versa. Refer to [Chapter 7 on page 131](#) for more information.

To change your ZyWALL's DNS settings, click **REMOTE MGMT**, then the **DNS** tab. The screen appears as shown. This feature is not available when the ZyWALL is set to bridge mode.

Figure 189 DNS

The screenshot shows the 'REMOTE MANAGEMENT' interface with the 'DNS' tab selected. The configuration fields are as follows:

- Service Port:** 53
- Service Access:** LAN & WAN & DMZ
- Secure Client IP Address:** All Selected 0 . 0 . 0 . 0

A note below the fields reads: "Note: You may also need to create a [Firewall rule](#)." At the bottom, there are 'Apply' and 'Reset' buttons.

The following table describes the labels in this screen.

Table 132 DNS

LABEL	DESCRIPTION
Server Port	The DNS service port number is 53 and cannot be changed here.
Service Access	Select the interface(s) through which a computer may send DNS queries to the ZyWALL.
Secure Client IP Address	A secure client is a "trusted" computer that is allowed to send DNS queries to the ZyWALL. Select All to allow any computer to send DNS queries to the ZyWALL. Choose Selected to just allow the computer with the IP address that you specify to send DNS queries to the ZyWALL.
Apply	Click Apply to save your customized settings.
Reset	Click Reset to begin configuring this screen afresh.

22.16 Introducing Vantage CNM

Vantage CNM (Centralized Network Management) is a browser-based global management solution that allows an administrator from any location to easily configure, manage, monitor and troubleshoot ZyXEL devices located worldwide. See the *Vantage CNM User's Guide* for details.

If you allow your ZyWALL to be managed by the Vantage CNM server, then you should not do any configurations directly to the ZyWALL (using either the web configurator, SMT menus or commands) without notifying the Vantage CNM administrator.

22.17 Configuring CNM

Vantage CNM is disabled on the device by default. Click **REMOTE MGMT** in the navigation panel and then click the **CNM** tab.

Figure 190 CNM

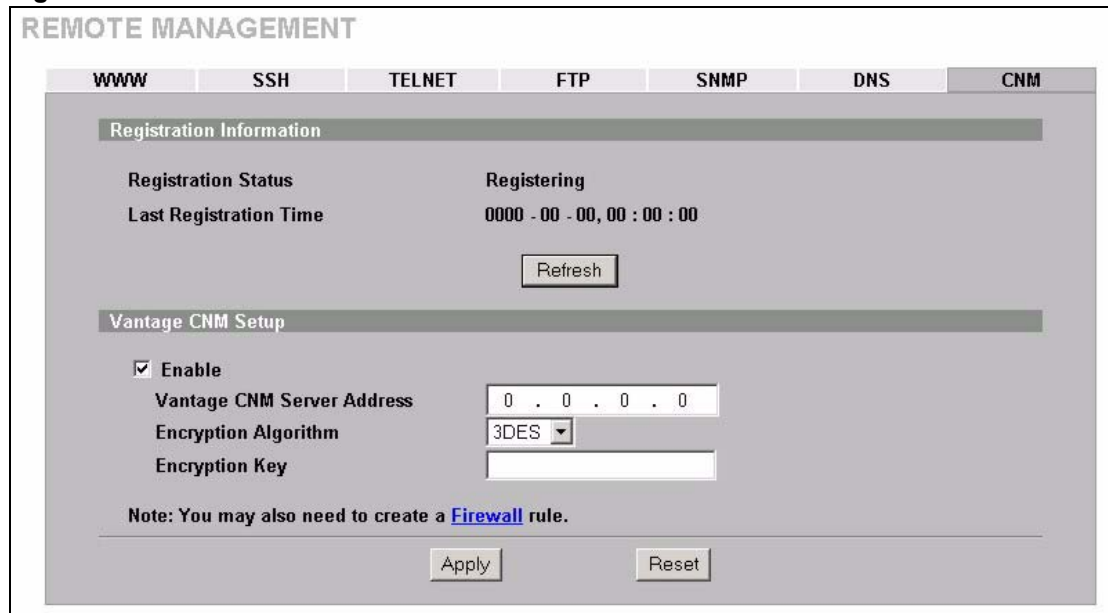

The following table describes the labels in this screen.

Table 133 CNM

LABEL	DESCRIPTION
Registration Information	
Registration Status	<p>This read only field displays Not Registered when Enable is not selected. It displays Registering when the ZyWALL first connects with the Vantage CNM server and then Registered after it has been successfully registered with the Vantage CNM server. It will continue to display Registering until it successfully registers with the Vantage CNM server. It will not be able to register with the Vantage CNM server if:</p> <ul style="list-style-type: none"> • The Vantage CNM server is down. • The Vantage CNM server IP address is incorrect. • The Vantage CNM server is behind a NAT router or firewall that does not forward packets through to the Vantage CNM server. • The encryption algorithms and/or encryption keys do not match between the ZyWALL and the Vantage CNM server.

Table 133 CNM (continued)

LABEL	DESCRIPTION
Last Registration Time	This field displays the last date (year-month-date) and time (hours-minutes-seconds) that the ZyWALL registered with the Vantage CNM server. It displays all zeroes if it has not yet registered with the Vantage CNM server.
Refresh	Click Refresh to update the registration status and last registration time.
Vantage CNM Setup	
Enable	Select this check box to allow Vantage CNM to manage your ZyWALL.
Vantage CNM Server Address	<p>If the Vantage server is on the same subnet as the ZyXEL device, enter the private or public IP address of the Vantage server.</p> <p>If the Vantage CNM server is on a different subnet to the ZyWALL, enter the public IP address of the Vantage server.</p> <p>If the Vantage CNM server is on a different subnet to the ZyWALL and is behind a NAT router, enter the WAN IP address of the NAT router here and configure the NAT router to forward UDP port 1864 traffic to the Vantage CNM server.</p> <p>If the Vantage CNM server is behind a firewall, you may have to create a rule on the firewall to allow UDP port 1864 traffic through to the Vantage CNM server (most (new) ZyXEL firewalls automatically allow this).</p>
Encryption Algorithm	The Encryption Algorithm field is used to encrypt communications between the ZyWALL and the Vantage CNM server. Choose from None (no encryption), DES or 3DES . The Encryption Key field appears when you select DES or 3DES . The ZyWALL must use the same encryption algorithm as the Vantage CNM server.
Encryption Key	Type eight alphanumeric characters ("0" to "9", "a" to "z" or "A" to "Z") when you choose the DES encryption algorithm and 24 alphanumeric characters ("0" to "9", "a" to "z" or "A" to "Z") when you choose the 3DES encryption algorithm. The ZyWALL must use the same encryption key as the Vantage CNM server.
Apply	Click Apply to save your changes back to the ZyWALL.
Reset	Click Reset to begin configuring this screen afresh.

CHAPTER 23

UPnP

This chapter introduces the Universal Plug and Play feature. This chapter is only applicable when the ZyWALL is in router mode.

23.1 Universal Plug and Play Overview

Universal Plug and Play (UPnP) is a distributed, open networking standard that uses TCP/IP for simple peer-to-peer network connectivity between devices. A UPnP device can dynamically join a network, obtain an IP address, convey its capabilities and learn about other devices on the network. In turn, a device can leave a network smoothly and automatically when it is no longer in use.

23.1.1 How Do I Know If I'm Using UPnP?

UPnP hardware is identified as an icon in the Network Connections folder (Windows XP). Each UPnP compatible device installed on your network will appear as a separate icon. Selecting the icon of a UPnP device will allow you to access the information and properties of that device.

23.1.2 NAT Traversal

UPnP NAT traversal automates the process of allowing an application to operate through NAT. UPnP network devices can automatically configure network addressing, announce their presence in the network to other UPnP devices and enable exchange of simple product and service descriptions. NAT traversal allows the following:

- Dynamic port mapping
- Learning public IP addresses
- Assigning lease times to mappings

Windows Messenger is an example of an application that supports NAT traversal and UPnP.

See [Chapter 17 on page 297](#) for further information about NAT.

23.1.3 Cautions with UPnP

The automated nature of NAT traversal applications in establishing their own services and opening firewall ports may present network security issues. Network information and configuration may also be obtained and modified by users in some network environments.

All UPnP-enabled devices may communicate freely with each other without additional configuration. Disable UPnP if this is not your intention.

23.2 UPnP and ZyXEL

ZyXEL has achieved UPnP certification from the Universal Plug and Play Forum Creates UPnP™ Implementers Corp. (UIC). ZyXEL's UPnP implementation supports IGD 1.0 (Internet Gateway Device). At the time of writing ZyXEL's UPnP implementation supports Windows Messenger 4.6 and 4.7 while Windows Messenger 5.0 and Xbox are still being tested.

The ZyWALL only sends UPnP multicasts to the LAN.

Please see later in this *User's Guide* for examples of installing UPnP in Windows XP and Windows Me as well as an example of using UPnP in Windows.

23.3 Configuring UPnP

Click **UPnP** to display the screen shown next.

Figure 191 Configuring UPnP

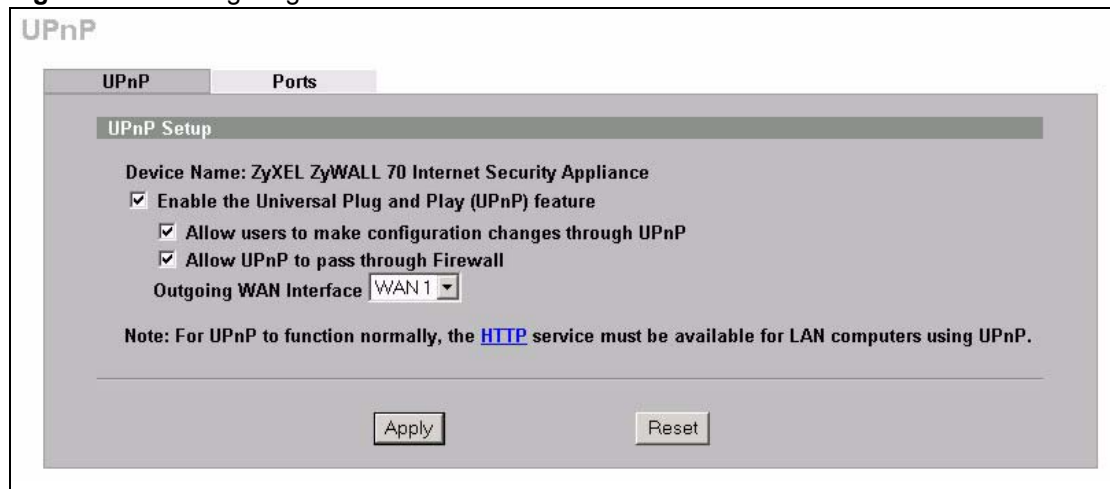

The following table describes the fields in this screen.

Table 134 Configuring UPnP

LABEL	DESCRIPTION
UPnP Setup	
Device Name	This identifies the ZyXEL device in UPnP applications.

Table 134 Configuring UPnP

LABEL	DESCRIPTION
Enable the Universal Plug and Play (UPnP) feature	Select this checkbox to activate UPnP. Be aware that anyone could use a UPnP application to open the web configurator's login screen without entering the ZyWALL's IP address (although you must still enter the password to access the web configurator).
Allow users to make configuration changes through UPnP	Select this check box to allow UPnP-enabled applications to automatically configure the ZyWALL so that they can communicate through the ZyWALL, for example by using NAT traversal. UPnP applications automatically reserve a NAT forwarding port in order to communicate with another UPnP enabled device; this eliminates the need to manually configure port forwarding for the UPnP enabled application.
Allow UPnP to pass through Firewall	Select this check box to allow traffic from UPnP-enabled applications to bypass the firewall. Clear this check box to have the firewall block all UPnP application packets (for example, MSN packets).
Outgoing WAN Interface	Select through which WAN port you want to send out traffic from UPnP-enabled applications. If the WAN port you select loses its connection, the ZyWALL attempts to use the other WAN port. If the other WAN port also does not work, the ZyWALL drops outgoing packets from UPnP-enabled applications.
Apply	Click Apply to save your changes back to the ZyWALL.
Reset	Click Reset to begin configuring this screen afresh.

23.4 Displaying UPnP Port Mapping

Click **UPnP** and then **Ports** to display the screen as shown next. Use this screen to view the NAT port mapping rules that UPnP creates on the ZyWALL.

Figure 192 UPnP Ports

The screenshot shows the 'UPnP Ports' configuration page. At the top, there are two tabs: 'UPnP' and 'Ports'. Below the tabs is a 'Ports Setup' section with a checked checkbox labeled 'Reserve UPnP NAT rules in flash after system bootup'. Underneath, it indicates 'WAN Interface in Use: WAN 1'. A table with the following columns is displayed: '#', 'Remote Host', 'External Port', 'Protocol', 'Internal Port', 'Internal Client', 'Enabled', 'Description', and 'Lease Duration'. At the bottom of the page, there are two buttons: 'Apply' and 'Refresh'.

The following table describes the labels in this screen.

Table 135 UPnP Ports

LABEL	DESCRIPTION
Reserve UPnP NAT rules in flash after system bootup	Select this check box to have the ZyWALL retain UPnP created NAT rules even after restarting. If you use UPnP and you set a port on your computer to be fixed for a specific service (for example FTP for file transfers), this option allows the ZyWALL to keep a record when your computer uses UPnP to create a NAT forwarding rule for that service.
WAN Interface in Use	This field displays through which WAN port the ZyWALL is currently sending out traffic from UPnP-enabled applications. This field displays None when UPnP is disabled or neither of the WAN ports has a connection.
The following read-only table displays information about the UPnP-created NAT mapping rule entries in the ZyWALL's NAT routing table.	
#	This is the index number of the UPnP-created NAT mapping rule entry.
Remote Host	This field displays the source IP address (on the WAN) of inbound IP packets. Since this is often a wildcard, the field may be blank. When the field is blank, the ZyWALL forwards all traffic sent to the External Port on the WAN interface to the Internal Client on the Internal Port . When this field displays an external IP address, the NAT rule has the ZyWALL forward inbound packets to the Internal Client from that IP address only.
External Port	This field displays the port number that the ZyWALL "listens" on (on the WAN port) for connection requests destined for the NAT rule's Internal Port and Internal Client . The ZyWALL forwards incoming packets (from the WAN) with this port number to the Internal Client on the Internal Port (on the LAN). If the field displays "0", the ZyWALL ignores the Internal Port value and forwards requests on all external port numbers (that are otherwise unmapped) to the Internal Client .
Protocol	This field displays the protocol of the NAT mapping rule (TCP or UDP).
Internal Port	This field displays the port number on the Internal Client to which the ZyWALL should forward incoming connection requests.
Internal Client	This field displays the DNS host name or IP address of a client on the LAN. Multiple NAT clients can use a single port simultaneously if the internal client field is set to 255.255.255.255 for UDP mappings.
Enabled	This field displays whether or not this UPnP-created NAT mapping rule is turned on. The UPnP-enabled device that connected to the ZyWALL and configured the UPnP-created NAT mapping rule on the ZyWALL determines whether or not the rule is enabled.
Description	This field displays a text explanation of the NAT mapping rule.
Lease Duration	This field displays a dynamic port-mapping rule's time to live (in seconds). It displays "0" if the port mapping is static.
Apply	Click Apply to save your changes back to the ZyWALL.
Refresh	Click Refresh update the screen's table.

23.5 Installing UPnP in Windows Example

This section shows how to install UPnP in Windows Me and Windows XP.

23.5.1 Installing UPnP in Windows Me

Follow the steps below to install UPnP in Windows Me.

- 1 Click **Start, Settings and Control Panel**. Double-click **Add/Remove Programs**.
- 2 Click on the **Windows Setup** tab and select **Communication** in the **Components** selection box. Click **Details**.
- 3 In the **Communications** window, select the **Universal Plug and Play** check box in the **Components** selection box.
- 4 Click **OK** to go back to the **Add/Remove Programs Properties** window and click **Next**.
- 5 Restart the computer when prompted.

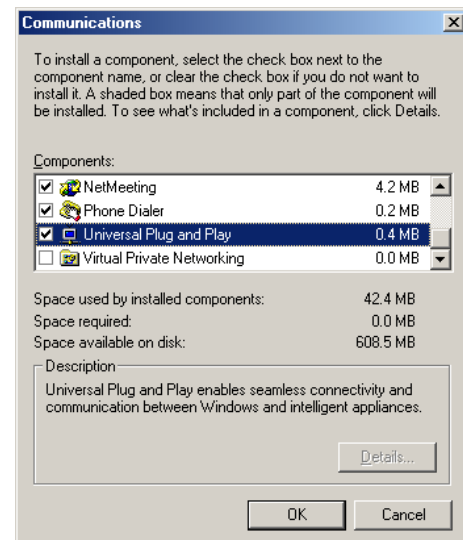
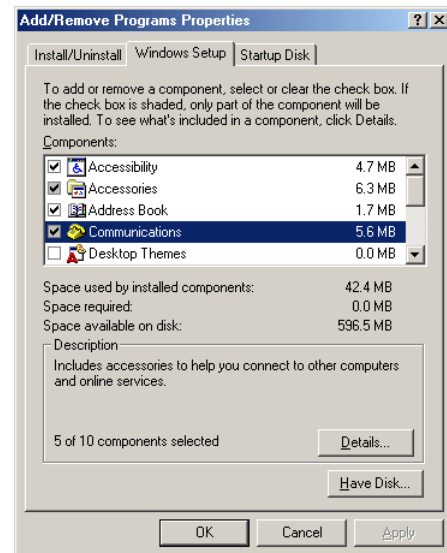

23.5.2 Installing UPnP in Windows XP

Follow the steps below to install UPnP in Windows XP.

- 1 Click **Start, Settings and Control Panel**.
- 2 Double-click **Network Connections**.
- 3 In the **Network Connections** window, click **Advanced** in the main menu and select **Optional Networking Components ...**.
The **Windows Optional Networking Components Wizard** window displays.
- 4 Select **Networking Service** in the **Components** selection box and click **Details**.
- 5 In the **Networking Services** window, select the **Universal Plug and Play** check box.
- 6 Click **OK** to go back to the **Windows Optional Networking Component Wizard** window and click **Next**.

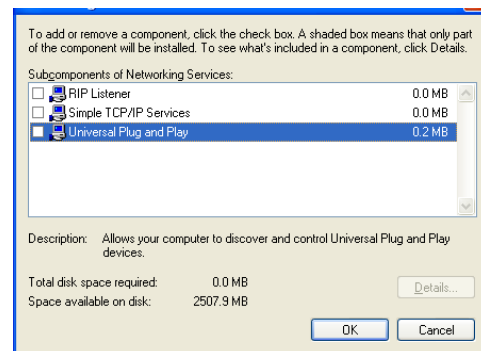
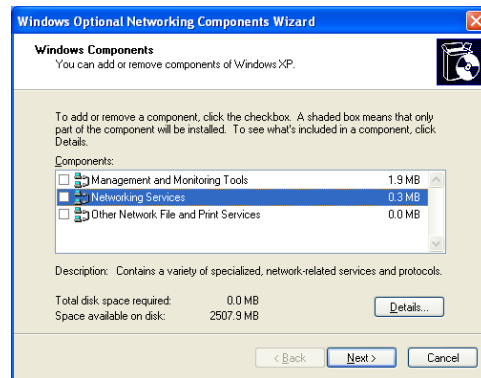
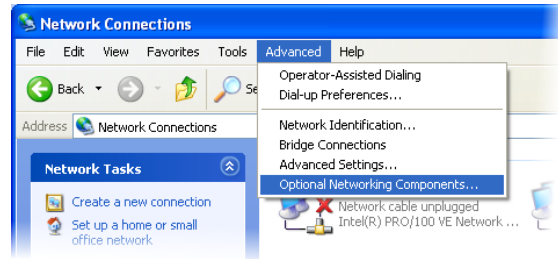

23.6 Using UPnP in Windows XP Example

This section shows you how to use the UPnP feature in Windows XP. You must already have UPnP installed in Windows XP and UPnP activated on the ZyXEL device.

Make sure the computer is connected to a LAN port of the ZyXEL device. Turn on your computer and the ZyXEL device.

23.6.1 Auto-discover Your UPnP-enabled Network Device

- 1 Click **Start** and **Control Panel**. Double-click **Network Connections**. An icon displays under **Internet Gateway**.
- 2 Right-click the icon and select **Properties**.

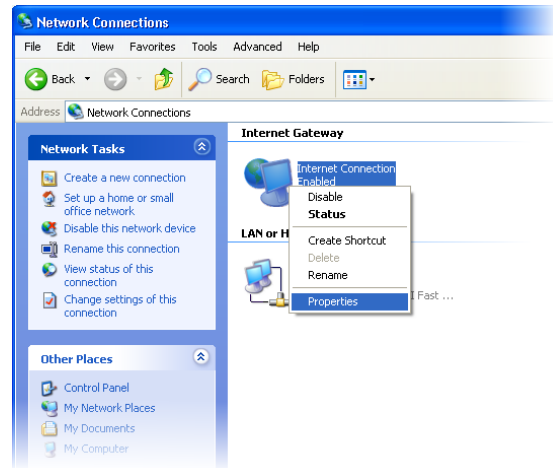

- 3 In the **Internet Connection Properties** window, click **Settings** to see the port mappings that were automatically created.

You may edit or delete the port mappings or click **Add** to manually add port mappings.

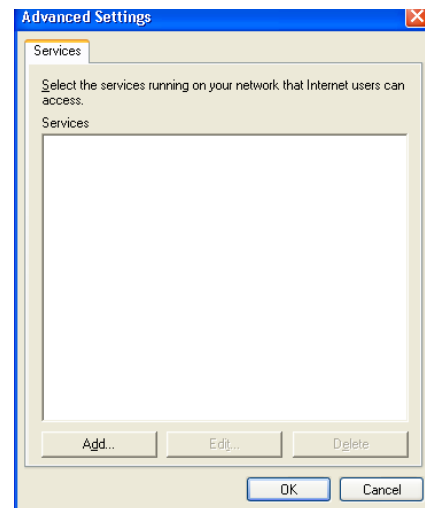
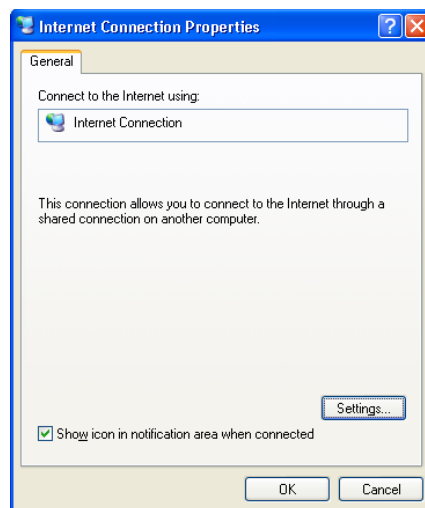

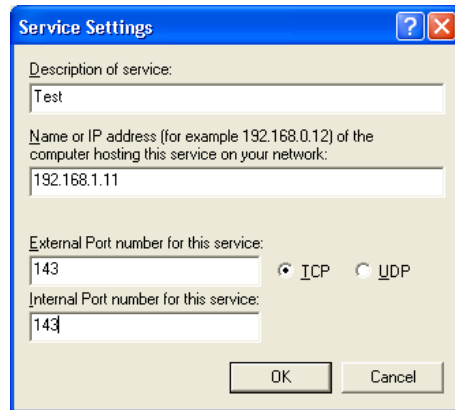

Note: When the UPnP-enabled device is disconnected from your computer, all port mappings will be deleted automatically.

- 4 Select the **Show icon in notification area when connected** check box and click **OK**. An icon displays in the system tray.

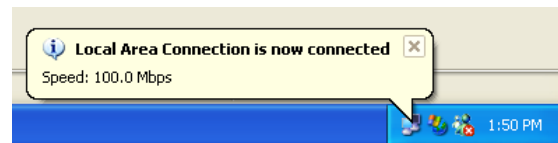

- 5 Double-click the icon to display your current Internet connection status.

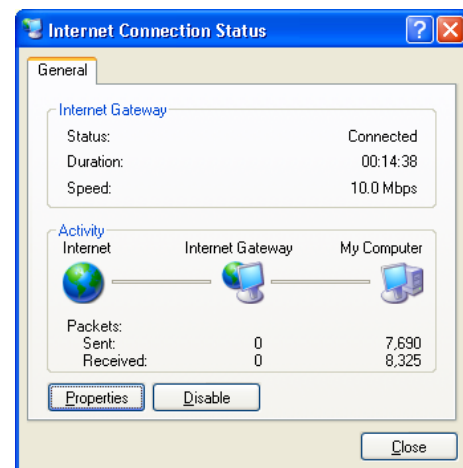

23.6.2 Web Configurator Easy Access

With UPnP, you can access the web-based configurator on the ZyXEL device without finding out the IP address of the ZyXEL device first. This is helpful if you do not know the IP address of the ZyXEL device.

Follow the steps below to access the web configurator.

- 1 Click **Start** and then **Control Panel**.
- 2 Double-click **Network Connections**.
- 3 Select **My Network Places** under **Other Places**.

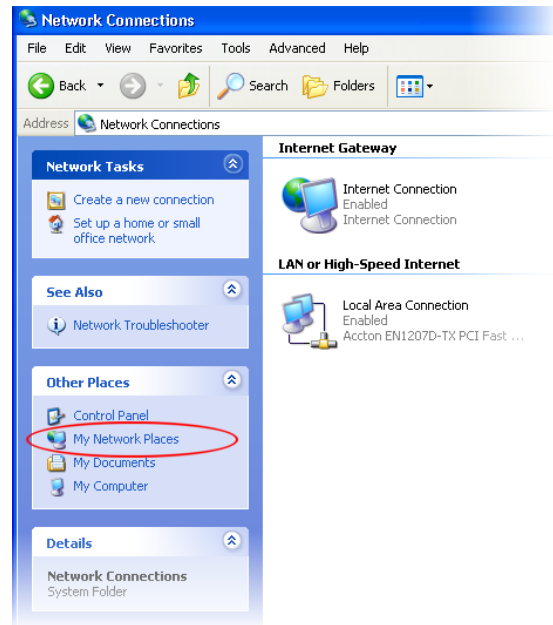

- 4 An icon with the description for each UPnP-enabled device displays under **Local Network**.
- 5 Right-click the icon for your ZyXEL device and select **Invoke**. The web configurator login screen displays.

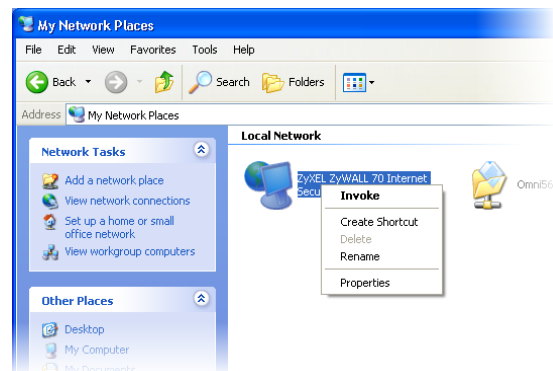

- 6 Right-click the icon for your ZyXEL device and select **Properties**. A properties window displays with basic information about the ZyXEL device.

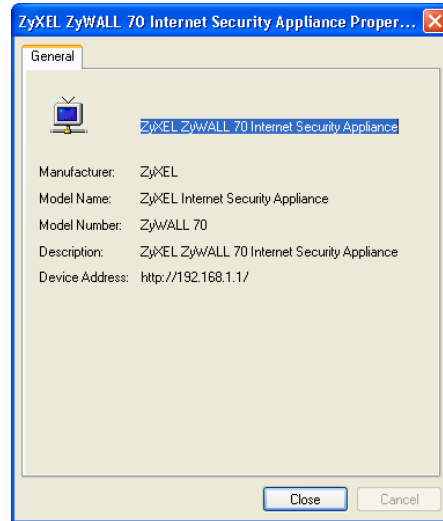

CHAPTER 24

Logs Screens

This chapter contains information about configuring general log settings and viewing the ZyWALL's logs. Refer to [Appendix R on page 677](#) for example log message explanations.

24.1 Configuring View Log

The web configurator allows you to look at all of the ZyWALL's logs in one location.

Click **LOGS** to open the **View Log** screen. Use the **View Log** screen to see the logs for the categories that you selected in the **Log Settings** screen (see [Section 24.3 on page 389](#)).

Options include logs about system maintenance, system errors, access control, allowed or blocked web sites, blocked web features (such as ActiveX controls, java and cookies), attacks (such as DoS) and IPSec.

Log entries in red indicate system error logs. The log wraps around and deletes the old entries after it fills. Click a column heading to sort the entries. A triangle indicates ascending or descending sort order.

Figure 193 View Log

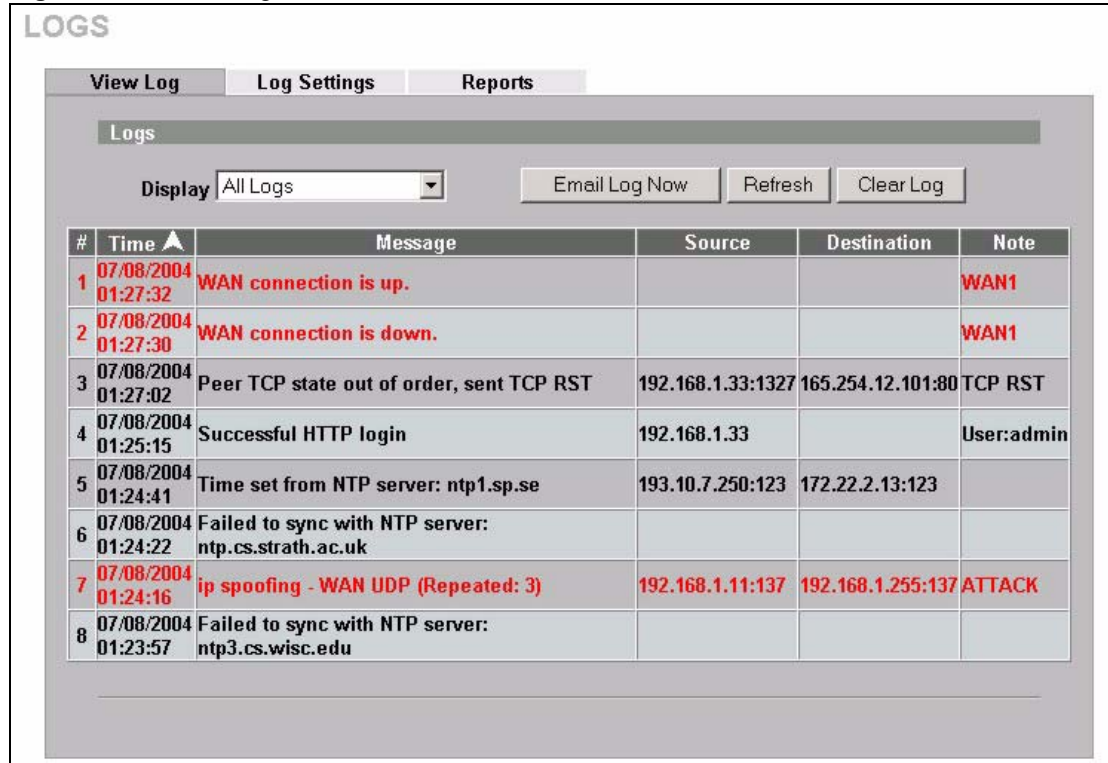

The following table describes the labels in this screen.

Table 136 View Log

LABEL	DESCRIPTION
Display	The categories that you select in the Log Settings page (see Section 24.3 on page 389) display in the drop-down list box. Select a category of logs to view; select All Logs to view logs from all of the log categories that you selected in the Log Settings page.
#	This field displays the log number.
Time	This field displays the time the log was recorded. See Section 25.5 on page 400 to configure the ZyWALL's time and date.
Message	This field states the reason for the log.
Source	This field lists the source IP address and the port number of the incoming packet.
Destination	This field lists the destination IP address and the port number of the incoming packet.
Note	This field displays additional information about the log entry.
Email Log Now	Click Email Log Now to send the log screen to the e-mail address specified in the Log Settings page (make sure that you have first filled in the E-mail Log Settings fields in Log Settings , see Section 24.3 on page 389).
Refresh	Click Refresh to renew the log screen.
Clear Log	Click Clear Log to delete all the logs.

24.2 Log Description Example

The following is an example of how a log displays in the command line interpreter and a description of the sample log. Refer to the appendices for more log message descriptions and details on using the command line interpreter to display logs.

```
# .time          source          destination
notes
message
5|06/08/2004 05:58:20 |172.21.4.187:137      |172.21.255.255:137
|ACCESS BLOCK
Firewall default policy: UDP (W to W/ZW)
```

Table 137 Example Log Description

LABEL	DESCRIPTION
#	This is log number five.
time	The log was generated on June 8, 2004 at 5:58 and 20 seconds AM.
source	The log was generated due to a NetBIOS packet sent from IP address 172.21.4.187 port 137.
destination	The NetBIOS packet was sent to the 172.21.255.255 subnet port 137. This was a NetBIOS UDP broadcast packet meant to discover devices on the network.
notes	The ZyWALL blocked the packet.
message	The ZyWALL blocked the packet in accordance with the firewall's default policy of blocking sessions that are initiated from the WAN. "UDP" means that this was a User Datagram Protocol packet. "W to W/ZW" indicates that the packet was traveling from the WAN to the WAN or the ZyWALL.

24.3 Configuring Log Settings

To change your ZyWALL's log settings, click **LOGS**, then the **Log Settings** tab. The screen appears as shown.

Use the **Log Settings** screen to configure to where the ZyWALL is to send logs; the schedule for when the ZyWALL is to send the logs and which logs and/or immediate alerts the ZyWALL is to send.

An alert is a type of log that warrants more serious attention. They include system errors, attacks (access control) and attempted access to blocked web sites or web sites with restricted web features such as cookies, active X and so on. Some categories such as **System Errors** consist of both logs and alerts. You may differentiate them by their color in the **View Log** screen. Alerts display in red and logs display in black.

Note: Alerts are e-mailed as soon as they happen. Logs may be e-mailed as soon as the log is full (see **Log Schedule**). Selecting many alert and/or log categories (especially **Access Control**) may result in many e-mails being sent.

Figure 194 Log Settings

LOGS

View Log
Log Settings
Reports

E-mail Log Settings

Mail Server (Outgoing SMTP Server Name or IP Address)
Mail Subject
Send Log to (E-Mail Address)
Send Alerts to (E-Mail Address)
Log Schedule
Day for Sending Log
Time for Sending Log (Hour) (Minute)

SMTP Authentication
User Name
Password

Syslog Logging

Active
Syslog Server (Server Name or IP Address)
Log Facility

Active Log and Alert

Log	Send Immediate Alert
<input checked="" type="checkbox"/> System Maintenance	<input type="checkbox"/> System Errors
<input checked="" type="checkbox"/> System Errors	<input type="checkbox"/> Access Control
<input checked="" type="checkbox"/> Access Control	<input type="checkbox"/> Blocked Web Sites
<input type="checkbox"/> Asymmetrical Routes	<input type="checkbox"/> Blocked Java etc.
<input type="checkbox"/> Multicasts / Broadcasts	<input type="checkbox"/> Attacks
<input type="checkbox"/> TCP Reset	<input type="checkbox"/> IPSec
<input type="checkbox"/> Packet Filter	<input type="checkbox"/> IKE
<input checked="" type="checkbox"/> ICMP	<input type="checkbox"/> PKI
<input checked="" type="checkbox"/> Remote Management	
<input checked="" type="checkbox"/> Call Record	
<input checked="" type="checkbox"/> PPP	
<input type="checkbox"/> UPnP	
<input type="checkbox"/> Forward Web Sites	
<input checked="" type="checkbox"/> Blocked Web Sites	
<input checked="" type="checkbox"/> Blocked Java etc.	
<input checked="" type="checkbox"/> Attacks	
<input checked="" type="checkbox"/> IPSec	
<input checked="" type="checkbox"/> IKE	
<input checked="" type="checkbox"/> PKI	
<input checked="" type="checkbox"/> SSL/TLS	
<input checked="" type="checkbox"/> 802.1X	
<input checked="" type="checkbox"/> Wireless	

Log Consolidation

Active
Log Consolidation Period 1 ~ 600 (Seconds)

The following table describes the labels in this screen.

Table 138 Log Settings

LABEL	DESCRIPTION
E-mail Log Settings	
Mail Server	Enter the server name or the IP address of the mail server for the e-mail addresses specified below. If this field is left blank, logs and alert messages will not be sent via e-mail.
Mail Subject	Type a title that you want to be in the subject line of the log e-mail message that the ZyWALL sends.
Send Log To	Logs are sent to the e-mail address specified in this field. If this field is left blank, logs will not be sent via e-mail.
Send Alerts To	Alerts are sent to the e-mail address specified in this field. If this field is left blank, alerts will not be sent via e-mail.
Log Schedule	<p>This drop-down menu is used to configure the frequency of log messages being sent as E-mail:</p> <ul style="list-style-type: none"> • Daily • Weekly • Hourly • When Log is Full • None. <p>If you select Weekly or Daily, specify a time of day when the E-mail should be sent. If you select Weekly, then also specify which day of the week the E-mail should be sent. If you select When Log is Full, an alert is sent when the log fills up. If you select None, no log messages are sent.</p>
Day for Sending Log	Use the drop down list box to select which day of the week to send the logs.
Time for Sending Log	Enter the time of the day in 24-hour format (for example 23:00 equals 11:00 pm) to send the logs.
SMTP Authentication	<p>SMTP (Simple Mail Transfer Protocol) is the message-exchange standard for the Internet. SMTP enables you to move messages from one e-mail server to another.</p> <p>Select the check box to activate SMTP authentication. If mail server authentication is needed but this feature is disabled, you will not receive the e-mail logs.</p>
User Name	Enter the user name (up to 31 characters) (usually the user name of a mail account).
Password	Enter the password associated with the user name above.
Syslog Logging	Syslog logging sends a log to an external syslog server used to store logs.
Active	Click Active to enable syslog logging.
Syslog Server	Enter the server name or IP address of the syslog server that will log the selected categories of logs.
Log Facility	Select a location from the drop down list box. The log facility allows you to log the messages to different files in the syslog server. Refer to the documentation of your syslog program for more details.
Active Log and Alert	
Log	Select the categories of logs that you want to record. Logs include alerts.
Send Immediate Alert	Select the categories of alerts for which you want the ZyWALL to instantly e-mail alerts to the e-mail address specified in the Send Alerts To field.
Log Consolidation	

Table 138 Log Settings (continued)

LABEL	DESCRIPTION
Active	Some logs (such as the Attacks logs) may be so numerous that it becomes easy to ignore other important log messages. Select this check box to merge logs with identical messages into one log. You can use the <code>sys log consolidate msglist</code> command to see what log messages will be consolidated.
Log Consolidation Period	Specify the time interval during which the ZyWALL merges logs with identical messages into one log.
Apply	Click Apply to save your changes back to the ZyWALL.
Reset	Click Reset to begin configuring this screen afresh.

24.4 Configuring Reports

The **Reports** page displays which computers on the LAN send and receive the most traffic, what kinds of traffic are used the most and which web sites are visited the most often. Use the **Reports** screen to have the ZyWALL record and display the following network usage details:

- Web sites visited the most often
- Number of times the most visited web sites were visited
- The most-used protocols or service ports
- The amount of traffic for the most used protocols or service ports
- The LAN IP addresses to and/or from which the most traffic has been sent
- How much traffic has been sent to and from the LAN IP addresses to and/or from which the most traffic has been sent

Note: The web site hit count may not be 100% accurate because sometimes when an individual web page loads, it may contain references to other web sites that also get counted as hits.

The ZyWALL records web site hits by counting the HTTP GET packets. Many web sites include HTTP GET references to other web sites and the ZyWALL may count these as hits, thus the web hit count is not (yet) 100% accurate.

To change your ZyWALL's log reports, click **LOGS**, then the **Reports** tab. The screen appears as shown.

Figure 195 Reports

Note: Enabling the ZyWALL's reporting function decreases the overall throughput by about 1 Mbps.

The following table describes the labels in this screen.

Table 139 Reports

LABEL	DESCRIPTION
Collect Statistics	Select the check box and click Apply to have the ZyWALL record report data.
Send Raw Traffic Statistics to Syslog Server for Analysis	Select the check box and click Apply to have the ZyWALL send unprocessed traffic statistics to a syslog server for analysis. You must have the syslog server already configured in the Log Settings screen.
Apply	Click Apply to save your changes back to the ZyWALL.
Reset	Click Reset to begin configuring this screen afresh.
Interface	Select on which interface (LAN or DMZ) the logs will be collected. The logs on the DMZ or LAN IP alias 1 and 2 are also recorded.
Report Type	Use the drop-down list box to select the type of reports to display. Web Site Hits displays the web sites that have been visited the most often from the LAN and how many times they have been visited. Protocol/Port displays the protocols or service ports that have been used the most and the amount of traffic for the most used protocols or service ports. LAN IP Address displays the LAN IP addresses to and /or from which the most traffic has been sent and how much traffic has been sent to and from those IP addresses.
Refresh	Click Refresh to update the report display. The report also refreshes automatically when you close and reopen the screen.
Flush	Click Flush to discard the old report data and update the report display.

Note: All of the recorded reports data is erased when you turn off the ZyWALL.

24.4.1 Viewing Web Site Hits

In the **Reports** screen, select **Web Site Hits** from the **Report Type** drop-down list box to have the ZyWALL record and display which web sites have been visited the most often and how many times they have been visited.

Figure 196 Web Site Hits Report Example

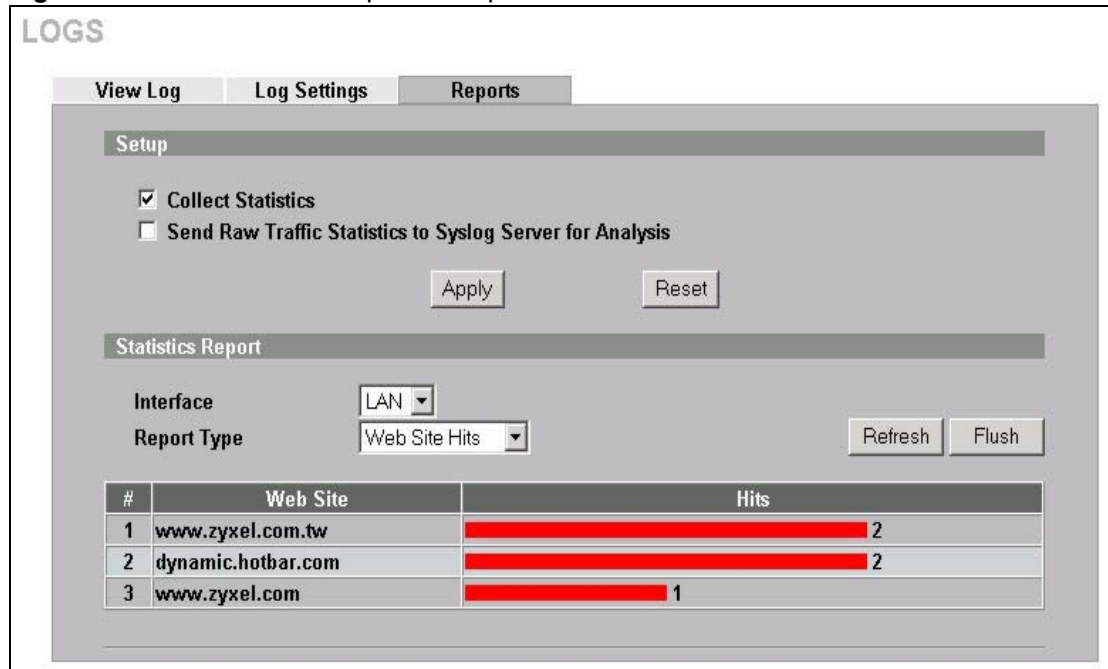

The following table describes the label in this screen.

Table 140 Web Site Hits Report

LABEL	DESCRIPTION
Web Site	This column lists the domain names of the web sites visited most often from computers on the LAN. The names are ranked by the number of visits to each web site and listed in descending order with the most visited web site listed first. The ZyWALL counts each page viewed in a web site as another hit on the web site.
Hits	This column lists how many times each web site has been visited. The count starts over at 0 if a web site passes the hit count limit (see Table 143 on page 396).

24.4.2 Viewing Protocol/Port

In the **Reports** screen, select **Protocol/Port** from the **Report Type** drop-down list box to have the ZyWALL record and display which protocols or service ports have been used the most and the amount of traffic for the most used protocols or service ports.

Figure 197 Protocol/Port Report Example

#	Protocol / Port	Direction	Amount
1	HTTP(TCP:80)	Incoming	280786 (bytes)
2	HTTP(TCP:80)	Outgoing	28489 (bytes)
3	DNS(TCP/UDP:53)	Incoming	26200 (bytes)
4	DNS(TCP/UDP:53)	Outgoing	14091 (bytes)
5	POP3(TCP:110)	Incoming	516 (bytes)
6	POP3(TCP:110)	Outgoing	364 (bytes)

The following table describes the labels in this screen.

Table 141 Protocol/ Port Report

LABEL	DESCRIPTION
Protocol/Port	This column lists the protocols or service ports for which the most traffic has gone through the ZyWALL. The protocols or service ports are listed in descending order with the most used protocol or service port listed first.
Direction	This field displays Incoming to denote traffic that is coming in from the WAN to the LAN or DMZ. This field displays Outgoing to denote traffic that is going out from the LAN or DMZ to the WAN.
Amount	This column lists how much traffic has been sent and/or received for each protocol or service port. The measurement unit shown (bytes, Kbytes, Mbytes or Gbytes) varies with the amount of traffic for the particular protocol or service port. The count starts over at 0 if a protocol or port passes the bytes count limit (see Table 143 on page 396).

24.4.3 Viewing LAN IP Address

In the **Reports** screen, select **LAN IP Address** from the **Report Type** drop-down list box to have the ZyWALL record and display the LAN IP addresses that the most traffic has been sent to and/or from and how much traffic has been sent to and/or from those IP addresses.

Note: Computers take turns using dynamically assigned LAN IP addresses. The ZyWALL continues recording the bytes sent to or from a LAN IP address when it is assigned to a different computer.

Figure 198 LAN IP Address Report Example

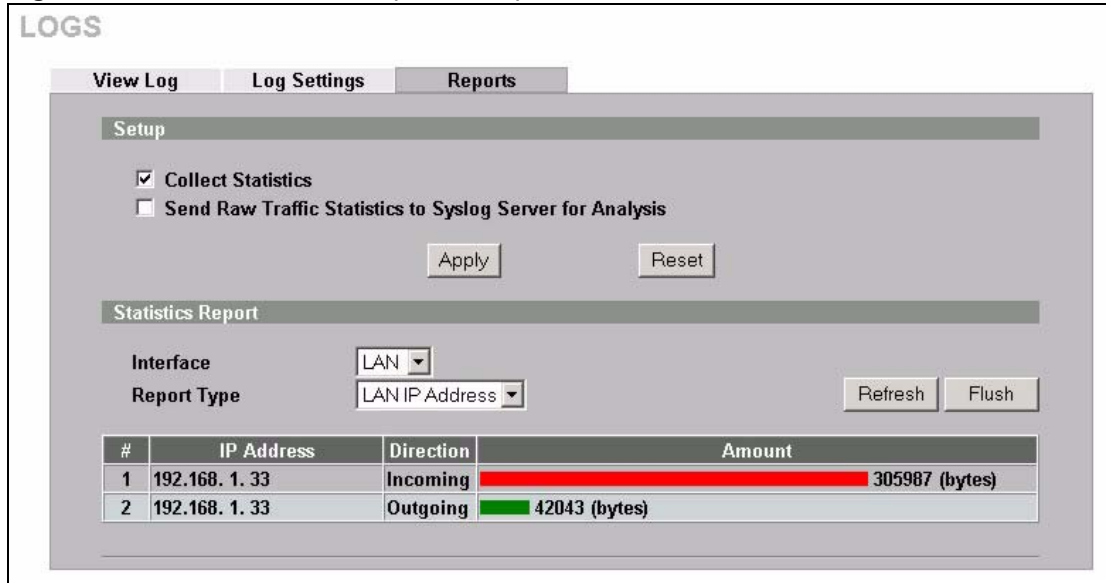

The following table describes the labels in this screen.

Table 142 LAN IP Address Report

LABEL	DESCRIPTION
IP Address	This column lists the LAN IP addresses to and/or from which the most traffic has been sent. The LAN IP addresses are listed in descending order with the LAN IP address to and/or from which the most traffic was sent listed first.
Direction	This field displays Incoming to denote traffic that is coming in from the WAN to the LAN or DMZ. This field displays Outgoing to denote traffic that is going out from the LAN or DMZ to the WAN.
Amount	This column displays how much traffic has gone to and from the listed LAN IP addresses. The measurement unit shown (bytes, Kbytes, Mbytes or Gbytes) varies with the amount of traffic sent to and from the LAN IP address. The count starts over at 0 if the total traffic sent to and from a LAN IP passes the bytes count limit (see Table 143 on page 396).

24.4.4 Reports Specifications

The following table lists detailed specifications on the reports feature.

Table 143 Report Specifications

LABEL	DESCRIPTION
Number of web sites/protocols or ports/IP addresses listed:	20
Hit count limit:	Up to 2 ³² hits can be counted per web site. The count starts over at 0 if it passes four billion.
Bytes count limit:	Up to 2 ⁶⁴ bytes can be counted per protocol/port or LAN IP address. The count starts over at 0 if it passes 2 ⁶⁴ bytes.

CHAPTER 25

Maintenance

This chapter displays information on the maintenance screens.

25.1 Maintenance Overview

The maintenance screens can help you view system information, upload new firmware, manage configuration and restart your ZyWALL.

25.2 General Setup

25.2.1 General Setup and System Name

General Setup contains administrative and system-related information. **System Name** is for identification purposes. However, because some ISPs check this name you should enter your computer's "Computer Name".

- In Windows 95/98 click **Start, Settings, Control Panel, Network**. Click the Identification tab, note the entry for the **Computer Name** field and enter it as the **System Name**.
- In Windows 2000, click **Start, Settings, Control Panel** and then double-click **System**. Click the **Network Identification** tab and then the **Properties** button. Note the entry for the **Computer name** field and enter it as the **System Name**.
- In Windows XP, click **Start, My Computer, View system information** and then click the **Computer Name** tab. Note the entry in the **Full computer name** field and enter it as the ZyWALL **System Name**.

25.2.2 Domain Name

The **Domain Name** entry is what is propagated to the DHCP clients on the LAN. If you leave this blank, the domain name obtained by DHCP from the ISP is used. While you must enter the host name (System Name), the domain name can be assigned from the ZyWALL via DHCP.

Click **MAINTENANCE** to open the **General** screen.

Figure 199 General Setup

The following table describes the labels in this screen.

Table 144 General Setup

LABEL	DESCRIPTION
General Setup	
System Name	Choose a descriptive name for identification purposes. It is recommended you enter your computer's "Computer name" in this field. This name can be up to 30 alphanumeric characters long. Spaces are not allowed, but dashes "-" and underscores "_" are accepted.
Domain Name	Enter the domain name (if you know it) here. If you leave this field blank, the ISP may assign a domain name via DHCP. The domain name entered by you is given priority over the ISP assigned domain name.
Administrator Inactivity Timer	Type how many minutes a management session (either via the web configurator or SMT) can be left idle before the session times out. The default is 5 minutes. After it times out you have to log in with your password again. Very long idle timeouts may have security risks. A value of "0" means a management session never times out, no matter how long it has been left idle (not recommended).
Apply	Click Apply to save your changes back to the ZyWALL.
Reset	Click Reset to begin configuring this screen afresh.

25.3 Configuring Password

To change your ZyWALL's password (recommended), click **MAINTENANCE**, then the **Password** tab. The screen appears as shown. This screen allows you to change the ZyWALL's password.

Figure 200 Password Setup

The screenshot shows the 'MAINTENANCE' interface with the 'Password' tab selected. The 'Password Setup' section contains three text input fields labeled 'Old Password', 'New Password', and 'Retype to Confirm'. Below these fields are two buttons: 'Apply' and 'Reset'.

The following table describes the labels in this screen.

Table 145 Password Setup

LABEL	DESCRIPTION
Old Password	Type the default password or the existing password you use to access the system in this field.
New Password	Type your new system password (up to 30 characters). Note that as you type a password, the screen displays a (*) for each character you type.
Retype to Confirm	Type the new password again for confirmation.
Apply	Click Apply to save your changes back to the ZyWALL.
Reset	Click Reset to begin configuring this screen afresh.

25.4 Pre-defined NTP Time Servers List

The ZyWALL uses the following pre-defined list of NTP time servers if you do not specify a time server or it cannot synchronize with the time server you specified.

Note: The ZyWALL can use this pre-defined list of time servers regardless of the **Time Protocol** you select.

When the ZyWALL uses the pre-defined list of NTP time servers, it randomly selects one server and tries to synchronize with it. If the synchronization fails, then the ZyWALL goes through the rest of the list in order from the first one tried until either it is successful or all the pre-defined NTP time servers have been tried.

Table 146 Default Time Servers

ntp1.cs.wisc.edu
ntp1.gbg.netnod.se
ntp2.cs.wisc.edu
tock.usno.navy.mil
ntp3.cs.wisc.edu

Table 146 Default Time Servers

ntp.cs.strath.ac.uk
ntp1.sp.se
time1.stupi.se
tick.stdtime.gov.tw
tock.stdtime.gov.tw
time.stdtime.gov.tw

25.5 Configuring Time and Date

To change your ZyWALL's time and date, click **MAINTENANCE**, then the **Time and Date** tab. The screen appears as shown. Use this screen to configure the ZyWALL's time based on your local time zone.

Figure 201 Time and Date

MAINTENANCE

General Password **Time and Date** Device Mode F/W Upload Configuration Restart

Current Time and Date

Current Time 02:17:56
Current Date 2004-07-07

Time and Date Setup

Manual

New Time (hh:mm:ss) 2 : 4 : 31
New Date (yyyy-mm-dd) 2004 - 7 - 7

Get from Time Server

Time Protocol NTP (RFC-1305)
Time Server Address* a.ntp.alphazed.net

* Optional. There is a pre-defined NTP time server list.

Time Zone Setup

Time Zone (GMT) Greenwich Mean Time : Dublin, Edinburgh, Lisbon, London

Enable Daylight Saving

Start Date Second Wednesday of January at 0 o'clock
End Date First Wednesday of January at 0 o'clock

The following table describes the labels in this screen.

Table 147 Time and Date

LABEL	DESCRIPTION
Current Time and Date	
Current Time	This field displays the time of your ZyWALL. Each time you reload this page, the ZyWALL synchronizes the time with the time server.
Current Date	This field displays the date of your ZyWALL. Each time you reload this page, the ZyWALL synchronizes the date with the time server.
Time and Date Setup	
Manual	Select this radio button to enter the time and date manually. If you configure a new time and date, Time Zone and Daylight Saving at the same time, the new time and date you entered has priority and the Time Zone and Daylight Saving settings do not affect it.
New Time (hh:mm:ss)	This field displays the last updated time from the time server or the last time configured manually. When you set Time and Date Setup to Manual , enter the new time in this field and then click Apply .
New Date (yyyy-mm-dd)	This field displays the last updated date from the time server or the last date configured manually. When you set Time and Date Setup to Manual , enter the new date in this field and then click Apply .
Get from Time Server	Select this radio button to have the ZyWALL get the time and date from the time server you specified below.
Time Protocol	Select the time service protocol that your time server uses. Not all time servers support all protocols, so you may have to check with your ISP/network administrator or use trial and error to find a protocol that works. The main difference between them is the format. Daytime (RFC 867) format is day/month/year/time zone of the server. Time (RFC 868) format displays a 4-byte integer giving the total number of seconds since 1970/1/1 at 0:0:0. The default, NTP (RFC 1305) , is similar to Time (RFC 868) .
Time Server Address	Enter the IP address or URL of your time server. Check with your ISP/network administrator if you are unsure of this information.
Synchronize Now	Click this button to have the ZyWALL get the time and date from a time server (see the Time Server Address field). This also saves your changes (including the time server address).
Time Zone Setup	
Time Zone	Choose the time zone of your location. This will set the time difference between your time zone and Greenwich Mean Time (GMT).
Enable Daylight Saving	Daylight saving is a period from late spring to early fall when many countries set their clocks ahead of normal local time by one hour to give more daytime light in the evening. Select this option if you use Daylight Saving Time.

Table 147 Time and Date (continued)

LABEL	DESCRIPTION
Start Date	<p>Configure the day and time when Daylight Saving Time starts if you selected Enable Daylight Saving. The o'clock field uses the 24 hour format. Here are a couple of examples:</p> <p>Daylight Saving Time starts in most parts of the United States on the first Sunday of April. Each time zone in the United States starts using Daylight Saving Time at 2 A.M. local time. So in the United States you would select First, Sunday, April and type 2 in the o'clock field.</p> <p>Daylight Saving Time starts in the European Union on the last Sunday of March. All of the time zones in the European Union start using Daylight Saving Time at the same moment (1 A.M. GMT or UTC). So in the European Union you would select Last, Sunday, March. The time you type in the o'clock field depends on your time zone. In Germany for instance, you would type 2 because Germany's time zone is one hour ahead of GMT or UTC (GMT+1).</p>
End Date	<p>Configure the day and time when Daylight Saving Time ends if you selected Enable Daylight Saving. The o'clock field uses the 24 hour format. Here are a couple of examples:</p> <p>Daylight Saving Time ends in the United States on the last Sunday of October. Each time zone in the United States stops using Daylight Saving Time at 2 A.M. local time. So in the United States you would select Last, Sunday, October and type 2 in the o'clock field.</p> <p>Daylight Saving Time ends in the European Union on the last Sunday of October. All of the time zones in the European Union stop using Daylight Saving Time at the same moment (1 A.M. GMT or UTC). So in the European Union you would select Last, Sunday, October. The time you type in the o'clock field depends on your time zone. In Germany for instance, you would type 2 because Germany's time zone is one hour ahead of GMT or UTC (GMT+1).</p>
Apply	Click Apply to save your changes back to the ZyWALL.
Reset	Click Reset to begin configuring this screen afresh.

25.5.1 Resetting the Time

The ZyWALL resets the time in the following instances:

- When you click **Synchronize Now**.
- On saving your changes.
- When the ZyWALL starts up.
- 24-hour intervals after starting.

25.5.2 Time Server Synchronization

Click the **Synchronize Now** button to get the time and date from the predefined time server or the time server you specified in the **Time Server Address** field.

When the **System Time and Date Synchronization in Process** screen appears, wait up to one minute.

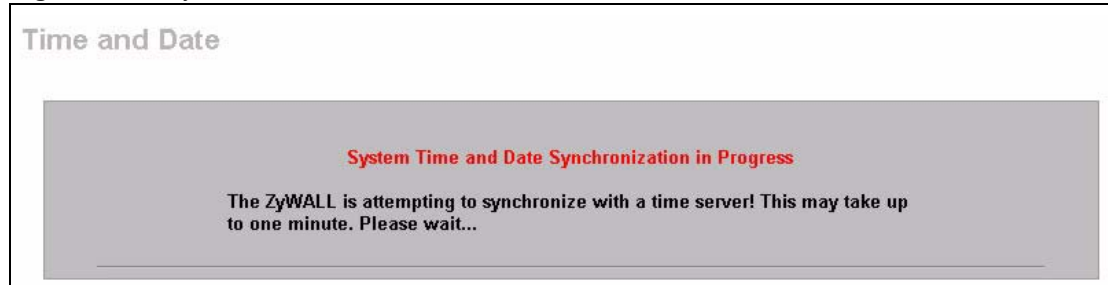
Figure 202 Synchronization in Process

Click the **Return** button to go back to the **Time and Date** screen after the time and date is updated successfully.

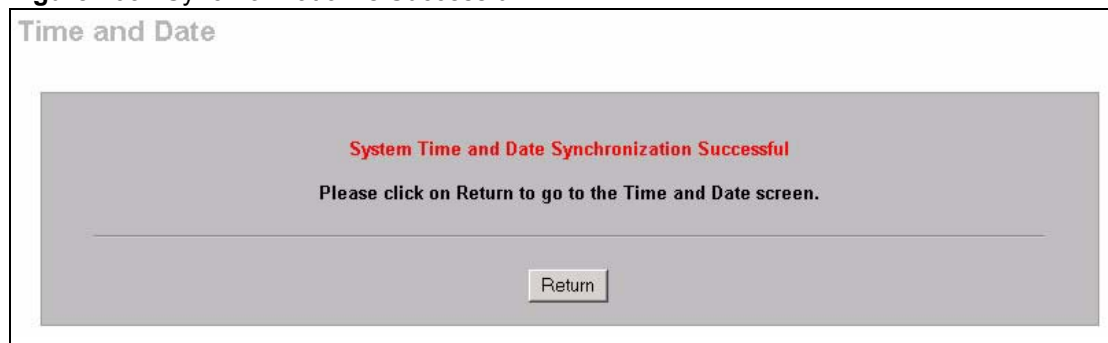
Figure 203 Synchronization is Successful

If the update was not successful, the following screen appears. Click **Return** to go back to the **Time and Date** screen.

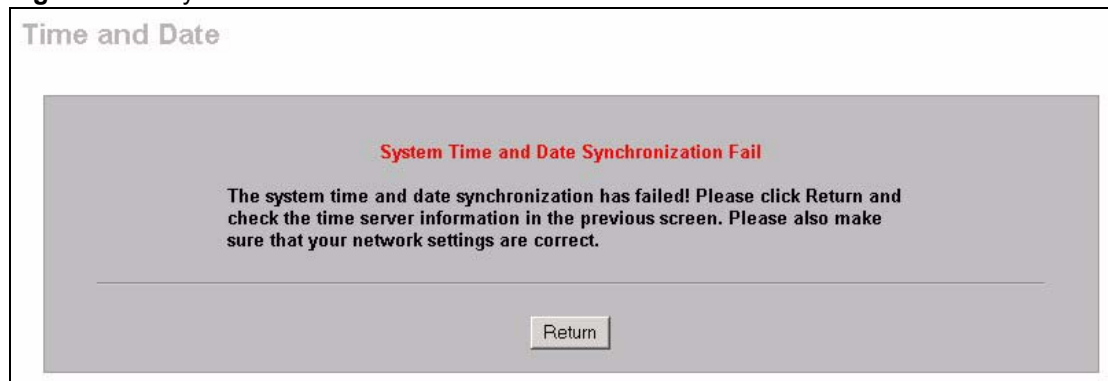
Figure 204 Synchronization Fail

25.6 Introduction To Transparent Bridging

A transparent bridge is invisible to the operation of a network in that it does not modify the frames it forwards. The bridge checks the source address of incoming frames on the port and learns MAC addresses to associate with that port. All future communications to that MAC address will only be sent on that port.

The bridge gradually builds a host MAC-address-to-port mapping table such as in the following example, during the learning process.

Table 148 MAC-address-to-port Mapping Table

HOST MAC ADDRESS	PORT
00a0c5123456	3
00a0c5123478 (host A)	1
00a0c512349a	3
00a0c51234bc	2
00a0c51234de	4

For example, if a bridge receives a frame via port 1 from host A (MAC address 00a0c5123478), the bridge associates host A with port 1. When the bridge receives another frame on one of its ports with destination address 00a0c5123478, it forwards the frame directly through port 1 after checking the internal table.

The bridge takes one of these actions after it checks the destination address of an incoming frame with its internal table:

- If the table contains an association between the destination address and any of the bridge's ports aside from the one on which the frame was received, the frame is forwarded out the associated port.
- If no association is found, the frame is flooded to all ports except the inbound port. Broadcasts and multicasts also are flooded in this way.
- If the associated port is the same as the incoming port, then the frame is dropped (filtered).

25.7 Transparent Firewalls

A transparent firewall (also known as a transparent, in-line, shadow, stealth or bridging firewall) has the following advantages over “router firewalls”:

- 1** The use of a bridging firewall reduces configuration and deployment time because no networking configuration changes to your existing network (hosts, neighboring routers and the firewall itself) are needed. Just put it in-line with the network it is protecting. As it only moves frames between ports (after inspecting them), it is completely transparent.
- 2** Performance is improved as there's less processing overhead.
- 3** As a transparent bridge does not modify the frames it forwards, it is effectively “stealth” as it is invisible to attackers.

Bridging devices are most useful in complex environments that require a rapid or new firewall deployment. A transparent, bridging firewall can also be good for companies with several branch offices since the setups at these offices are often the same and it's likely that one design can be used for many of the networks. A bridging firewall could be configured at HQ, sent to the branches and then installed directly without additional configuration.

25.8 Configuring Device Mode

To configure and have your ZyWALL work as a router or a bridge, click **MAINTENANCE**, then the **Device Mode** tab. When the ZyWALL is in router mode, the screen appears as shown next.

Figure 205 Device Mode (Router Mode)

The following table describes the labels in this screen.

Table 149 Device Mode (Router Mode)

LABEL	DESCRIPTION
Current Device Mode	
Device Mode	This displays whether the ZyWALL is functioning as a router or a bridge.
Device Mode Setup	
Router	When the ZyWALL is in router mode, there is no need to select or clear this radio button.
IP Address	Click LAN , WAN or DMZ to go to the LAN , WAN or DMZ screen where you can view and/or change the corresponding settings.
Bridge	Select this radio button and configure the following fields, then click Apply to set the ZyWALL to bridge mode.
IP Address	Enter the IP address of your ZyWALL in dotted decimal notation.

Table 149 Device Mode (Router Mode) (continued)

LABEL	DESCRIPTION
Subnet Mask	Enter the IP subnet mask of the ZyWALL.
Gateway IP Address	Enter the gateway IP address.
Apply	Click Apply to save your changes back to the ZyWALL. After you click Apply , please wait for one minute and use the IP address you configured in the IP Address field to access the ZyWALL again.
Reset	Click Reset to begin configuring this screen afresh.

When the ZyWALL is in bridge mode, the screen appears as shown next

Figure 206 Device Mode (Bridge Mode)

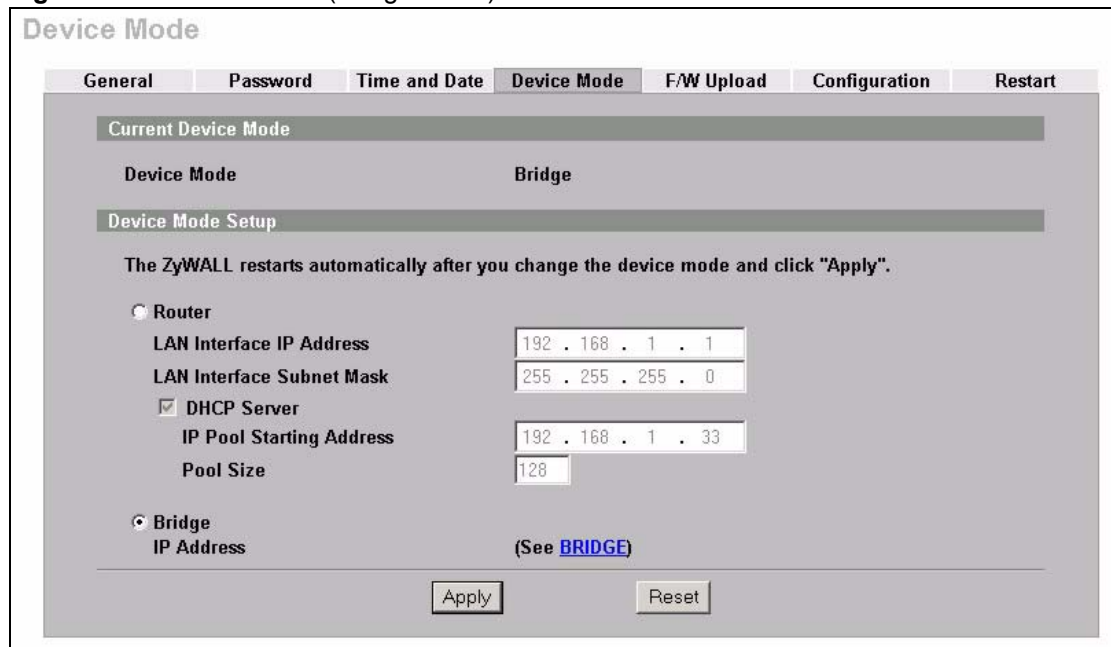

The following table describes the labels in this screen.

Table 150 Device Mode (Bridge Mode)

LABEL	DESCRIPTION
Current Device Mode	
Device Mode	This displays whether the ZyWALL is functioning as a router or a bridge.
Device Mode Setup	
Router	Select this radio button and click Apply to set the ZyWALL to router mode.
LAN Interface IP Address	Enter the IP address of your ZyWALL' s LAN port in dotted decimal notation. 192.168.1.1 is the factory default.
LAN Interface Subnet Mask	Enter the IP subnet mask of the ZyWALL's LAN port.

Table 150 Device Mode (Bridge Mode) (continued)

LABEL	DESCRIPTION
DHCP Server	DHCP (Dynamic Host Configuration Protocol, RFC 2131 and RFC 2132) allows individual clients (computers) to obtain TCP/IP configuration at startup from a server. Unless you are instructed by your ISP, leave the DHCP Server check box selected. Clear it to stop the ZyWALL from acting as a DHCP server. When configured as a server, the ZyWALL provides TCP/IP configuration for the clients. If not, DHCP service is disabled and you must have another DHCP server on your LAN, or else the computers must be manually configured. When set as a server, fill in the rest of the DHCP setup fields.
IP Pool Starting Address	This field specifies the first of the contiguous addresses in the IP address pool.
Pool Size	This field specifies the size, or count of the IP address pool.
Bridge	When the ZyWALL is in bridge mode, there is no need to select or clear this radio button.
IP Address	Click Bridge to go to the Bridge screen where you can view and/or change the bridge settings.
Apply	Click Apply to save your changes back to the ZyWALL. After you click Apply , please wait for one minute and use the IP address you configured in the LAN Interface IP Address field to access the ZyWALL again.
Reset	Click Reset to begin configuring this screen afresh.

25.9 F/W Upload Screen

Find firmware at www.zyxel.com in a file that (usually) uses the system model name with a .bin extension, for example, "zywall.bin". The upload process uses HTTP (Hypertext Transfer Protocol) and may take up to two minutes. After a successful upload, the system will reboot. See [Section 40.5 on page 532](#) for upgrading firmware using FTP/TFTP commands.

Click **MAINTENANCE**, and then the **F/W UPLOAD** tab. Follow the instructions in this screen to upload firmware to your ZyWALL.

Figure 207 Firmware Upload

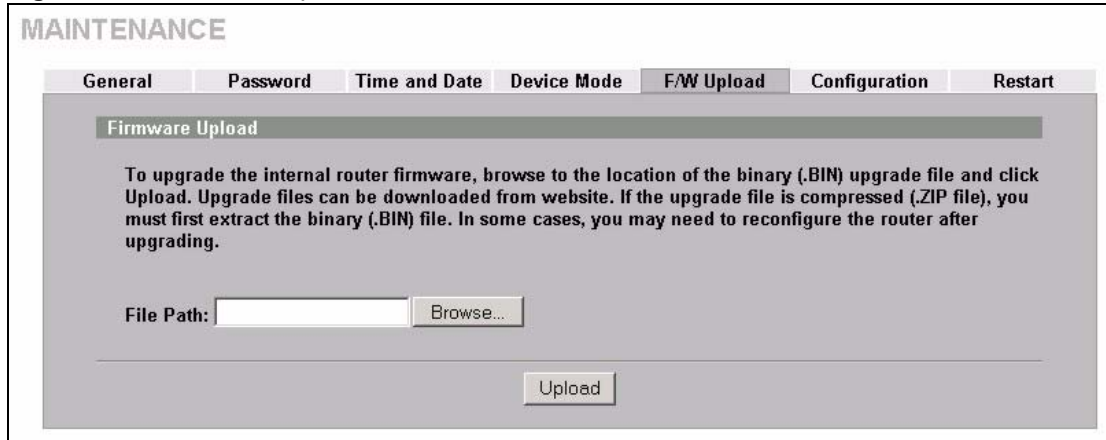

The following table describes the labels in this screen.

Table 151 Firmware Upload

LABEL	DESCRIPTION
File Path	Type in the location of the file you want to upload in this field or click Browse ... to find it.
Browse...	Click Browse... to find the .bin file you want to upload. Remember that you must decompress compressed (.zip) files before you can upload them.
Upload	Click Upload to begin the upload process. This process may take up to two minutes.

Note: Do not turn off the ZyWALL while firmware upload is in progress!

After you see the **Firmware Upload in Process** screen, wait two minutes before logging into the ZyWALL again.

Figure 208 Firmware Upload In Process

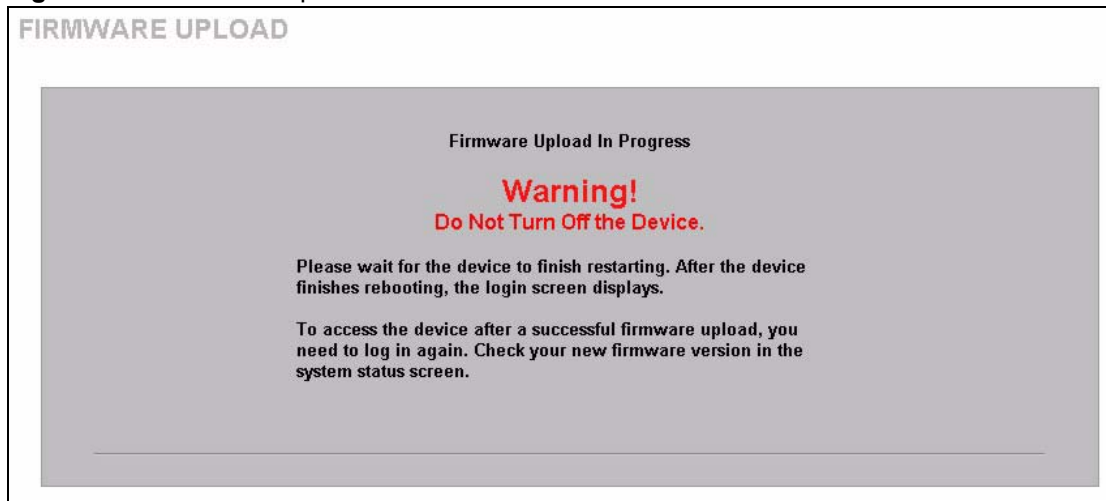

The ZyWALL automatically restarts in this time causing a temporary network disconnect. In some operating systems, you may see the following icon on your desktop.

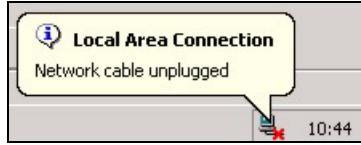
Figure 209 Network Temporarily Disconnected

After two minutes, log in again and check your new firmware version in the **System Status** screen.

If the upload was not successful, the following screen will appear. Click **Return** to go back to the **F/W Upload** screen.

Figure 210 Firmware Upload Error

25.10 Configuration Screen

See [Section 40.5 on page 532](#) for transferring configuration files using FTP/TFTP commands.

Click **MAINTENANCE**, and then the **Configuration** tab. Information related to factory defaults, backup configuration, and restoring configuration appears as shown next.

Figure 211 Configuration

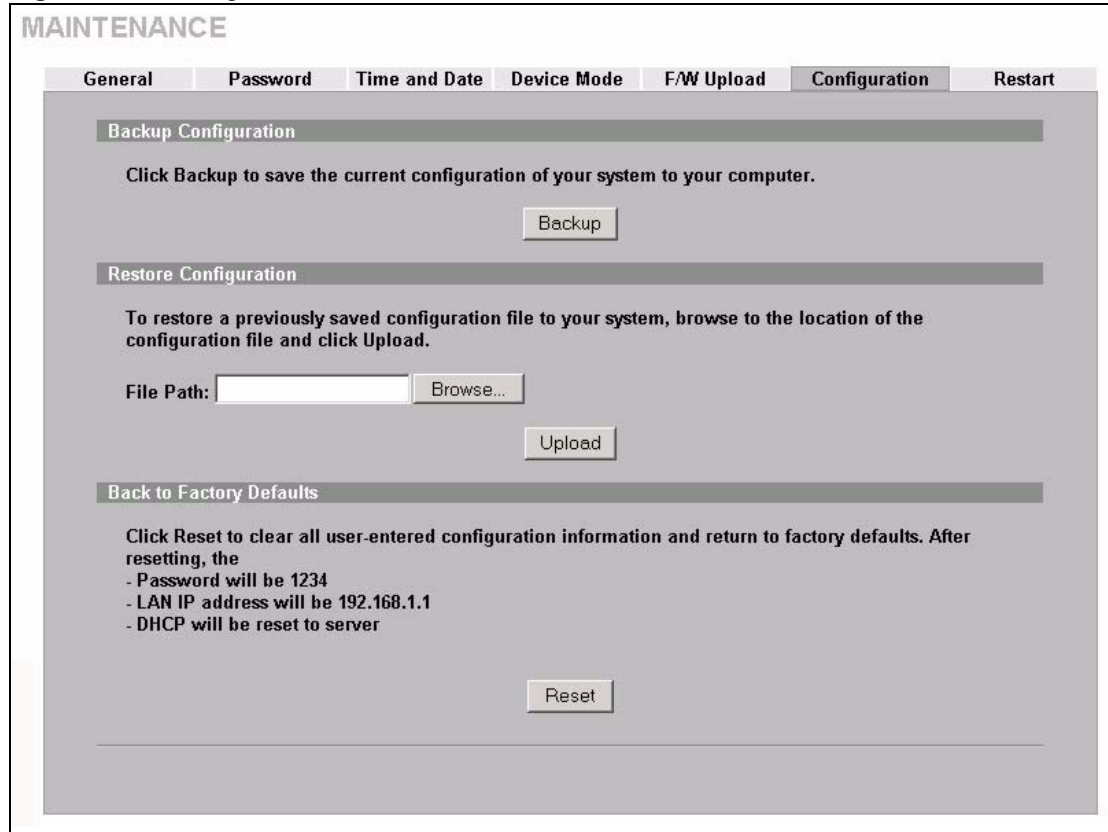

25.10.1 Backup Configuration

Backup Configuration allows you to back up (save) the ZyWALL’s current configuration to a file on your computer. Once your ZyWALL is configured and functioning properly, it is highly recommended that you back up your configuration file before making configuration changes. The backup configuration file will be useful in case you need to return to your previous settings.

Click **Backup** to save the ZyWALL’s current configuration to your computer.

25.10.2 Restore Configuration

Restore Configuration allows you to upload a new or previously saved configuration file from your computer to your ZyWALL.

Table 152 Restore Configuration

LABEL	DESCRIPTION
File Path	Type in the location of the file you want to upload in this field or click Browse ... to find it.
Browse...	Click Browse... to find the file you want to upload. Remember that you must decompress compressed (.ZIP) files before you can upload them.
Upload	Click Upload to begin the upload process.

Note: Do not turn off the ZyWALL while configuration file upload is in progress.

After you see a “restore configuration successful” screen, you must then wait one minute before logging into the ZyWALL again.

Figure 212 Configuration Upload Successful



The ZyWALL automatically restarts in this time causing a temporary network disconnect. In some operating systems, you may see the following icon on your desktop.

Figure 213 Network Temporarily Disconnected



If you uploaded the default configuration file you may need to change the IP address of your computer to be in the same subnet as that of the default device IP address (192.168.1.1). See your *Quick Start Guide* for details on how to set up your computer's IP address.

If the upload was not successful, the following screen will appear. Click **Return** to go back to the **Configuration** screen.

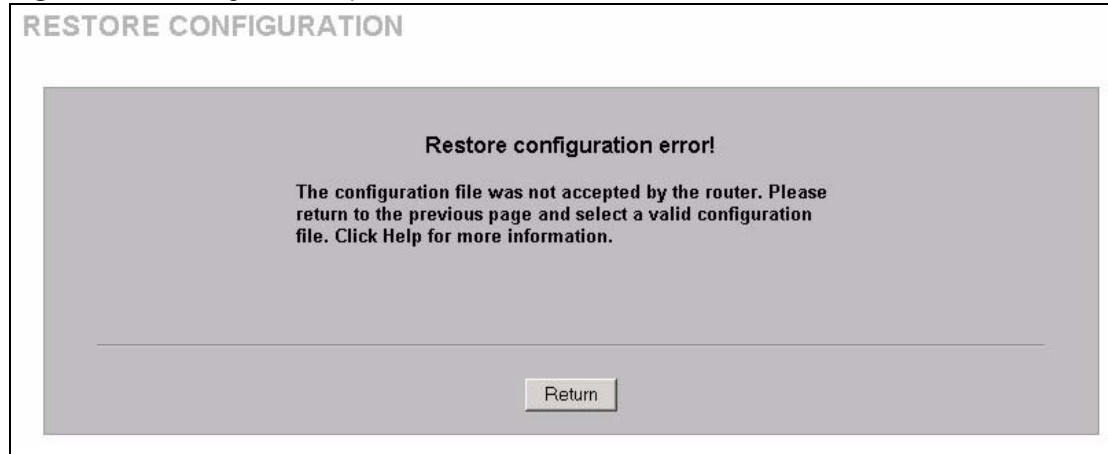
Figure 214 Configuration Upload Error

25.10.3 Back to Factory Defaults

Pressing the **Reset** button in this section clears all user-entered configuration information and returns the ZyWALL to its factory defaults as shown on the screen. The following warning screen will appear.

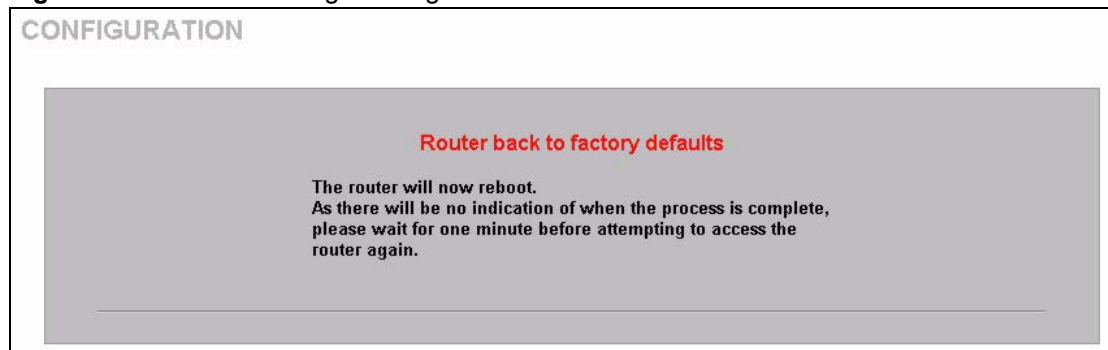
Figure 215 Reset Warning Message

You can also press the **RESET** button on the rear panel to reset the factory defaults of your ZyWALL. Refer to [Section 2.3 on page 60](#) for more information on the **RESET** button.

25.11 Restart Screen

System restart allows you to reboot the ZyWALL without turning the power off.

Click **MAINTENANCE**, and then **Restart**. Click **Restart** to have the ZyWALL reboot. This does not affect the ZyWALL's configuration.

Figure 216 Restart Screen

CHAPTER 26

Introducing the SMT

This chapter explains how to access the System Management Terminal and gives an overview of its menus.

26.1 Introduction to the SMT

The ZyWALL's SMT (System Management Terminal) is a menu-driven interface that you can access from a terminal emulator through the console port or over a telnet connection. This chapter shows you how to access the SMT (System Management Terminal) menus via console port, how to navigate the SMT and how to configure SMT menus.

26.2 Accessing the SMT via the Console Port

Make sure you have the physical connection properly set up as described in the *Quick Start Guide*.

When configuring using the console port, you need a computer equipped with communications software configured to the following parameters:

- VT100 terminal emulation.
- 9600 Baud.
- No parity, 8 data bits, 1 stop bit, flow control set to none.

26.2.1 Initial Screen

When you turn on your ZyWALL, it performs several internal tests as well as line initialization.

After the tests, the ZyWALL asks you to press [ENTER] to continue, as shown next.

Figure 217 Initial Screen

```

Copyright (c) 1994 - 2004 ZyXEL Communications Corp.

initialize ch =0, ethernet address: 00:A0:C5:01:23:45
initialize ch =1, ethernet address: 00:A0:C5:01:23:46
initialize ch =2, ethernet address: 00:A0:C5:01:23:47
initialize ch =3, ethernet address: 00:A0:C5:01:23:48
initialize ch =4, ethernet address: 00:00:00:00:00:00
AUX port init . done
Modem init . inactive

Press ENTER to continue...
    
```

26.2.2 Entering the Password

The login screen appears after you press [ENTER], prompting you to enter the password, as shown below.

For your first login, enter the default password “1234”. As you type the password, the screen displays an “X” for each character you type.

Please note that if there is no activity for longer than five minutes after you log in, your ZyWALL will automatically log you out and display a blank screen. If you see a blank screen, press [ENTER] to bring up the login screen again.

Figure 218 Password Screen

```

Enter Password : XXXX
    
```

26.3 Navigating the SMT Interface

The SMT is an interface that you use to configure your ZyWALL.

Several operations that you should be familiar with before you attempt to modify the configuration are listed in the table below.

Table 153 Main Menu Commands

OPERATION	KEYSTROKES	DESCRIPTION
Move down to another menu	[ENTER]	To move forward to a submenu, type in the number of the desired submenu and press [ENTER].
Move up to a previous menu	[ESC]	Press the [ESC] key to move back to the previous menu.

Table 153 Main Menu Commands

OPERATION	KEYSTROKES	DESCRIPTION
Move to a "hidden" menu	Press [SPACE BAR] to change No to Yes then press [ENTER].	Fields beginning with "Edit" lead to hidden menus and have a default setting of No. Press [SPACE BAR] to change No to Yes, and then press [ENTER] to go to a "hidden" menu.
Move the cursor	[ENTER] or [UP]/[DOWN] arrow keys	Within a menu, press [ENTER] to move to the next field. You can also use the [UP]/[DOWN] arrow keys to move to the previous and the next field, respectively. When you are at the top of a menu, press the [UP] arrow key to move to the bottom of a menu.
Entering information	Fill in, or press [SPACE BAR], then press [ENTER] to select from choices.	You need to fill in two types of fields. The first requires you to type in the appropriate information. The second allows you to cycle through the available choices by pressing [SPACE BAR].
Required fields	<? >	All fields with the symbol <?> must be filled in order be able to save the new configuration.
N/A fields	<N/A>	Some of the fields in the SMT will show a <N/A>. This symbol refers to an option that is Not Applicable.
Save your configuration	[ENTER]	Save your configuration by pressing [ENTER] at the message "Press ENTER to confirm or ESC to cancel". Saving the data on the screen will take you, in most cases to the previous menu. Make sure you save your settings in each screen that you configure.
Exit the SMT	Type 99, then press [ENTER].	Type 99 at the main menu prompt and press [ENTER] to exit the SMT interface.

26.3.1 Main Menu

After you enter the password, the SMT displays the **ZyWALL Main Menu**, as shown next.

Figure 219 Main Menu (Router Mode)

```

Copyright (c) 1994 - 2004 ZyXEL Communications Corp.

ZyWALL 70 Main Menu

Getting Started
  1. General Setup
  2. WAN Setup
  3. LAN Setup
  4. Internet Access Setup
  5. DMZ Setup
  6. Route Setup
Advanced Applications
  11. Remote Node Setup
  12. Static Routing Setup
  15. NAT Setup
Advanced Management
  21. Filter and Firewall Setup
  22. SNMP Configuration
  23. System Password
  24. System Maintenance
  25. IP Routing Policy Setup
  26. Schedule Setup

99. Exit

Enter Menu Selection Number:

```

Figure 220 Main Menu (Bridge Mode)

```

Copyright (c) 1994 - 2004 ZyXEL Communications Corp.

ZyWALL 70 Main Menu

Getting Started
  1. General Setup
Advanced Management
  21. Filter and Firewall Setup
  22. SNMP Configuration
  23. System Password
  24. System Maintenance

99. Exit

Enter Menu Selection Number:

```

The following table describes the fields in this menu.

Table 154 Main Menu Summary

NO.	MENU TITLE	FUNCTION
1	General Setup	Use this menu to set up device mode, dynamic DNS and administrative information.
2	WAN Setup	Use this menu to clone a MAC address from a computer on your LAN and configure the backup WAN dial-up connection.

Table 154 Main Menu Summary

NO.	MENU TITLE	FUNCTION
3	LAN Setup	Use this menu to apply LAN filters, configure LAN DHCP and TCP/IP settings and configure the wireless LAN port.
4	Internet Access Setup	Configure your Internet Access setup (Internet address, gateway, login, etc.) with this menu.
5	DMZ Setup	Use this menu to configure your public servers connected to the DMZ port.
6	Route Setup	Use this menu to configure your WAN route assessment, traffic redirect properties and failover parameters.
11	Remote Node Setup	Use this menu to configure detailed remote node settings (your ISP is also a remote node) as well as apply WAN filters.
12	Static Routing Setup	Configure IP static routes in this menu.
15	NAT Setup	Use this menu to configure Network Address Translation.
21	Filter and Firewall Setup	Configure filters, activate/deactivate the firewall and view the firewall log.
22	SNMP Configuration	Use this menu to configure SNMP-related parameters.
23	System Password	Change your password in this menu (recommended).
24	System Maintenance	From displaying system status to uploading firmware, this menu provides comprehensive system maintenance.
25	IP Routing Policy Setup	From displaying system status to uploading firmware, this menu provides comprehensive system maintenance.
26	Schedule Setup	Use this menu to schedule outgoing calls.
99	Exit	Use this menu to exit (necessary for remote configuration).

26.3.2 SMT Menus Overview

The following table gives you an overview of your ZyWALL's various SMT menus.

Table 155 SMT Menus Overview

MENUS	SUB MENUS		
1 General Setup	1.1 Configure Dynamic DNS	1.1.1 DDNS Host Summary	1.1.1 DDNS Edit Host
2 WAN Setup	2.1 Advanced WAN Setup		
3 LAN Setup	3.1 LAN Port Filter Setup		
	3.2 TCP/IP and DHCP Setup	3.2.1 IP Alias Setup	
	3.5 Wireless LAN Setup	3.5.1 WLAN MAC Address Filter	
4 Internet Access Setup			
5. DMZ Setup	5.1 DMZ Port Filter Setup		
	5.2 TCP/IP Setup	5.2.1 IP Alias Setup	
6. Route Setup	6.1 Route Assessment		
	6.2 Traffic Redirect		
	6.3 Route Failover		

Table 155 SMT Menus Overview (continued)

MENUS	SUB MENUS		
11 Remote Node Setup	11.1 Remote Node Profile	11.1.2 Remote Node Network Layer Options	
		11.1.4 Remote Node Filter	
	11.2 Remote Node Profile	11.2.2 Remote Node Network Layer Options	
		11.2.4 Remote Node Filter	
	11.3 Remote Node Profile (Backup ISP)	11.3.1 Remote Node PPP Options	
		11.3.2 Remote Node Network Layer Options	
		11.3.3 Remote Node Script	
11.3.4 Remote Node Filter			
12 Static Routing Setup	12.1 Edit Static Route Setup		
15 NAT Setup	15.1 Address Mapping Sets	15.1.x Address Mapping Rules	15.1.x.x Address Mapping Rule
	15.2 NAT Server Sets	15.2.x NAT Server Setup	15.2.x.x - NAT Server Configuration
	15.3 Trigger Ports	15.3.x Trigger Port Setup	
21 Filter and Firewall Setup	21.1 Filter Set Configuration	21.1.x Filter Rules Summary	21.1.x.x Generic Filter Rule
			21.1.x.x TCP/IP Filter Rule
	21.2 Firewall Setup		
23 System Password			

Table 155 SMT Menus Overview (continued)

MENUS	SUB MENUS		
24 System Maintenance	24.1 System Status		
	24.2 System Information and Console Port Speed	24.2.1 System Information	
		24.2.2 Console Port Speed	
	24.3 Log and Trace	24.3.1 View Error Log	
		24.3.2 Syslog Logging	
		24.3.4 Call-Triggering Packet	
	24.4 Diagnostic		
	24.5 Backup Configuration		
	24.6 Restore Configuration		
	24.7 Upload Firmware	24.7.1 Upload System Firmware	
		24.7.2 Upload System Configuration File	
	24.8 Command Interpreter Mode		
	24.9 Call Control	24.9.1 Budget Management	
24.9.2 Call History			
24.10 Time and Date Setting			
24.11 Remote Management Setup			
25 IP Routing Policy Summary	25.1 IP Routing Policy Setup	25.1.1 IP Routing Policy Setup	
26 Schedule Setup	26.1 Schedule Set Setup		

26.4 Changing the System Password

Change the system password by following the steps shown next.

- 1 Enter 23 in the main menu to open **Menu 23 - System Password** as shown next.

Figure 221 Menu 23: System Password

Menu 23 - System Password

Old Password= ?
New Password= ?
Retype to confirm= ?

Enter here to CONFIRM or ESC to CANCEL:

- 2** Type your existing password and press [ENTER].
- 3** Type your new system password and press [ENTER].
- 4** Re-type your new system password for confirmation and press [ENTER].

Note that as you type a password, the screen displays an “x” for each character you type.

26.5 Resetting the ZyWALL

See [Chapter 2 on page 59](#) for directions on resetting the ZyWALL.

CHAPTER 27

SMT Menu 1 - General Setup

Menu 1 - General Setup contains administrative and system-related information.

27.1 Introduction to General Setup

Menu 1 - General Setup contains administrative and system-related information.

27.2 Configuring General Setup

- 1 Enter 1 in the main menu to open **Menu 1 - General Setup**.
- 2 The **Menu 1 - General Setup** screen appears, as shown next. Fill in the required fields.

Figure 222 Menu 1: General Setup (Router Mode)

```

Menu 1 - General Setup

System Name=
Domain Name=

Device Mode= Router Mode

Edit Dynamic DNS= No

Press ENTER to Confirm or ESC to Cancel:

```

The following table describes the fields in this menu.

Table 156 Menu 1: General Setup (Router Mode)

FIELD	DESCRIPTION
System Name	Choose a descriptive name for identification purposes. It is recommended you enter your computer's "Computer name" in this field. This name can be up to 30 alphanumeric characters long. Spaces are not allowed, but dashes "-" and underscores "_" are accepted.
Domain Name	Enter the domain name (if you know it) here. If you leave this field blank, the ISP may assign a domain name via DHCP. You can go to menu 24.8 and type "sys domain name" to see the current domain name used by your router. The domain name entered by you is given priority over the ISP assigned domain name. If you want to clear this field just press [SPACE BAR] and then [ENTER].
Device Mode	Press [SPACE BAR] and then [ENTER] to select Router Mode .

Table 156 Menu 1: General Setup (Router Mode) (continued)

FIELD	DESCRIPTION
Edit Dynamic DNS	Press [SPACE BAR] and then [ENTER] to select Yes or No (default). Select Yes to configure Menu 1.1: Configure Dynamic DNS discussed next.
When you have completed this menu, press [ENTER] at the prompt "Press ENTER to Confirm..." to save your configuration, or press [ESC] at any time to cancel.	

Figure 223 Menu 1: General Setup (Bridge Mode)

```

Menu 1 - General Setup

System Name=
Domain Name=

Device Mode= Bridge Mode

IP Address= 192.168.1.1
Network Mask= 255.255.255.0
Gateway= 0.0.0.0
First System DNS Server
  IP Address= 0.0.0.0
Second System DNS Server
  IP Address= 0.0.0.0
Third System DNS Server
  IP Address= 0.0.0.0

Press ENTER to Confirm or ESC to Cancel:

```

The following table describes the fields not previously discussed (see [Table 156 on page 423](#)).

Table 157 Menu 1: General Setup (Bridge Mode)

FIELD	DESCRIPTION
Device Mode	Press [SPACE BAR] and then [ENTER] to select Bridge Mode .
IP Address	Enter the IP address of your ZyWALL in dotted decimal notation.
Network Mask	Enter the subnet mask of your ZyWALL.
Gateway	Enter the gateway IP address.
First System DNS Server Second System DNS Server Third System DNS Server	Enter the DNS server's IP address(es) in the IP Address field(s) if you have the IP address(es) of the DNS server(s).

27.2.1 Configuring Dynamic DNS

To configure Dynamic DNS, set the ZyWALL to router mode in menu 1 or in the **MAINTENANCE Device Mode** screen and go to **Menu 1 - General Setup** and press [SPACE BAR] to select **Yes** in the **Edit Dynamic DNS** field. Press [ENTER] to display **Menu 1.1 - Configure Dynamic DNS** (shown next).

Figure 224 Menu 1.1: Configure Dynamic DNS

```

Menu 1.1 - Configure Dynamic DNS

Service Provider= WWW.DynDNS.ORG
Active= No
Username=
Password= *****
Edit Host= No

Press ENTER to Confirm or ESC to Cancel:

```

Follow the instructions in the next table to configure Dynamic DNS parameters.

Table 158 Menu 1.1: Configure Dynamic DNS

FIELD	DESCRIPTION
Service Provider	This is the name of your Dynamic DNS service provider.
Active	Press [SPACE BAR] to select Yes and then press [ENTER] to make dynamic DNS active.
Username	Enter your user name.
Password	Enter the password assigned to you.
Edit Host	Press [SPACE BAR] and then [ENTER] to select Yes if you want to configure a DDNS host.
When you have completed this menu, press [ENTER] at the prompt "Press ENTER to Confirm..." to save your configuration, or press [ESC] at any time to cancel.	

27.2.1.1 Editing DDNS Host

To configure a DDNS host, follow the procedure below.

- 1 Configure your ZyWALL as a router in menu 1 or the **MAINTENANCE Device Mode** screen.
- 2 Enter 1 in the main menu to open **Menu 1 - General Setup**.
- 3 Press [SPACE BAR] to select **Yes** in the **Edit Dynamic DNS** field. Press [ENTER] to display **Menu 1.1 - Configure Dynamic DNS**.
- 4 Press [SPACE BAR] and then [ENTER] to select **Yes** in the **Edit Host** field. Press [ENTER] to display **Menu 1.1.1 - DDNS Host Summary**.

Figure 225 Menu 1.1.1: DDNS Host Summary

```

Menu 1.1.1 DDNS Host Summary

#          Summary
-----
01  Hostname=ZyWALL,
    Type=Dynamic,WC=Yes,Offline=No,Policy=DDNS Server
    Detect, WAN1, HA=Yes
02  _____
03  _____
04  _____
05  _____

Select Command= None          Select Rule= N/A
Press ENTER to Confirm or ESC to Cancel:
    
```

The following table describes the fields in this screen.

Table 159 Menu 1.1.1: DDNS Host Summary

FIELD	DESCRIPTION
#	This is the DDNS host index number.
Summary	This displays the details about the DDNS host.
Select Command	Press [SPACE BAR] to choose from None , Edit , Delete , Next Page or Previous Page and then press [ENTER]. You must select a DDNS host in the next field when you choose the Edit or Delete commands. Select None and then press [ENTER] to go to the "Press ENTER to Confirm..." prompt. Use Edit to create or edit a rule. Use Delete to remove a rule. To edit or delete a DDNS host, first make sure you are on the correct page. When a rule is deleted, subsequent rules do not move up in the page list. Select Next Page or Previous Page to view the next or previous page of DDNS hosts (respectively).
Select Rule	Type the DDNS host index number you wish to edit or delete and then press [ENTER].
When you have completed this menu, press [ENTER] at the prompt "Press ENTER to Confirm..." to save your configuration, or press [ESC] at any time to cancel.	

- 5 Select **Edit** in the **Select Command** field; type the index number of the DDNS host you want to configure in the **Select Rule** field and press [ENTER] to open **Menu 1.1.1 - DDNS Edit Host** (see the next figure).

Figure 226 Menu 1.1.1: DDNS Edit Host

```

Menu 1.1.1 - DDNS Edit Host

Hostname= ZyWALL
DDNS Type= DynamicDNS
Enable Wildcard Option= Yes
Enable Off Line Option= N/A
Bind WAN= 1
HA= Yes
IP Address Update Policy:
  Let DDNS Server Auto Detect= Yes
  Use User-Defined= N/A
  Use WAN IP Address= N/A

Press ENTER to Confirm or ESC to Cancel:

```

The following table describes the fields in this screen.

Table 160 Menu 1.1.1: DDNS Edit Host

FIELD	DESCRIPTION
Host Name	Enter your host name in this field.
DDNS Type	Press [SPACE BAR] and then [ENTER] to select DynamicDNS if you have the Dynamic DNS service. Select StaticDNS if you have the Static DNS service. Select CustomDNS if you have the Custom DNS service.
Enable Wildcard Option	Your ZyWALL supports DYNDNS Wildcard. Press [SPACE BAR] and then [ENTER] to select Yes or No . This field is N/A when you choose DDNS client as your service provider.
Enable Off Line Option	This field is only available when CustomDNS is selected in the DDNS Type field. Press [SPACE BAR] and then [ENTER] to select Yes . When Yes is selected, http://www.dyndns.org/ traffic is redirected to a URL that you have previously specified (see www.dyndns.org for details).
Bind WAN	Enter the WAN port to use for updating the IP address of the domain name.
HA	Press [SPACE BAR] and then [ENTER] to select Yes to enable the high availability (HA) feature. If the WAN port specified in the Bind WAN field does not have a connection, the ZyWALL will attempt to use the IP address of another WAN port to update the domain name. When the WAN ports are in the active/passive operating mode, the ZyWALL will update the domain name with the IP address of whichever WAN port has a connection, regardless of the setting in the Bind WAN field. Clear this check box and the ZyWALL will not update the domain name with an IP address if the WAN port specified in the Bind WAN field does not have a connection. Note: If you enable high availability, DDNS can also function when the ZyWALL uses the dial backup port. DDNS does not function when the ZyWALL uses traffic redirect. Refer to Section 21.10.2 on page 350 for detailed information.

Table 160 Menu 1.1.1: DDNS Edit Host (continued)

FIELD	DESCRIPTION
IP Address Update Policy:	<p>You can select Yes in either the Let DDNS Server Auto Detect field (recommended) or the Use User-Defined field, but not both.</p> <p>With the Let DDNS Server Auto Detect and Use User-Defined fields both set to No, the DDNS server automatically updates the IP address of the host name(s) with the ZyWALL's WAN IP address.</p> <p>DDNS does not work with a private IP address. When both fields are set to No, the ZyWALL must have a public WAN IP address in order for DDNS to work.</p>
Let DDNS Server Auto Detect	<p>Only select this option when there are one or more NAT routers between the ZyWALL and the DDNS server. Press [SPACE BAR] to select Yes and then press [ENTER] to have the DDNS server automatically detect and use the IP address of the NAT router that has a public IP address.</p> <p>Note: The DDNS server may not be able to detect the proper IP address if there is an HTTP proxy server between the ZyWALL and the DDNS server.</p>
Use User-Defined	<p>Press [SPACE BAR] to select Yes and then press [ENTER] to update the IP address of the host name(s) to the IP address specified below.</p> <p>Only select Yes if the ZyWALL uses or is behind a static public IP address.</p>
Use WAN IP Address	<p>Enter the static public IP address if you select Yes in the Use User-Defined field.</p>
<p>When you have completed this menu, press [ENTER] at the prompt "Press ENTER to Confirm..." to save your configuration, or press [ESC] at any time to cancel.</p>	

The IP address updates when you reconfigure menu 1 or perform DHCP client renewal.

CHAPTER 28

WAN and Dial Backup Setup

This chapter describes how to configure the WAN using menu 2 and dial-backup using menus 2.1 and 11.1.

28.1 Introduction to WAN and Dial Backup Setup

This chapter explains how to configure settings for your WAN port and how to configure the ZyWALL for a dial backup connection.

28.2 WAN Setup

From the main menu, enter 2 to open menu 2.

Figure 227 MAC Address Cloning in WAN Setup

```
Menu 2 - WAN Setup

WAN 1 MAC Address:
Assigned By= Factory default
IP Address= N/A
WAN 2 MAC Address:
Assigned By= Factory default
IP Address= N/A

Dial-Backup:
Active= No
Port Speed= 115200
AT Command String:
Init= at&fs0=0
Edit Advanced Setup= No

Press ENTER to Confirm or ESC to Cancel:
```

The following table describes the fields in this screen.

Table 161 MAC Address Cloning in WAN Setup

FIELD	DESCRIPTION
WAN 1/2 MAC Address	
Assigned By	Press [SPACE BAR] and then [ENTER] to choose one of two methods to assign a MAC Address. Choose Factory Default to select the factory assigned default MAC Address. Choose IP address attached on LAN to use the MAC Address of that computer whose IP you give in the following field.
IP Address	This field is applicable only if you choose the IP address attached on LAN method in the Assigned By field. Enter the IP address of the computer on the LAN whose MAC you are cloning.
When you have completed this menu, press [ENTER] at the prompt "Press ENTER to Confirm..." to save your configuration, or press [ESC] at any time to cancel.	

28.3 Dial Backup

The Dial Backup port can be used in reserve, as a traditional dial-up connection should the broadband connection to the WAN port fail. To set up the auxiliary port (Dial Backup) for use in the event that the regular WAN connection is dropped, first make sure you have set up the switch and port connection (see the *Quick Start Guide*), then configure

- 1 Menu 2 - WAN Setup,
- 2 Menu 2.1 - Advanced WAN Setup and
- 3 Menu 11.1 - Remote Node Profile (Backup ISP) as shown next

Refer also to the section about traffic redirect for information on an alternate backup WAN connection.

28.4 Configuring Dial Backup in Menu 2

From the main menu, enter 2 to open menu 2.

Figure 228 Menu 2: Dial Backup Setup

```

Menu 2 - WAN Setup

WAN 1 MAC Address:
Assigned By= Factory default
IP Address= N/A
WAN 2 MAC Address:
Assigned By= Factory default
IP Address= N/A

Dial-Backup:
Active= No
Port Speed= 115200
AT Command String:
Init= at&fs0=0
Edit Advanced Setup= Yes

Press ENTER to Confirm or ESC to Cancel:

```

The following table describes the fields in this menu.

Table 162 Menu 2: Dial Backup Setup

FIELD	DESCRIPTION
Dial-Backup:	
Active	Use this field to turn the dial-backup feature on (Yes) or off (No).
Port Speed	Press [SPACE BAR] and then press [ENTER] to select the speed of the connection between the Dial Backup port and the external device. Available speeds are: 9600, 19200, 38400, 57600, 115200 or 230400 bps.
AT Command String:	
Init	Enter the AT command string to initialize the WAN device. Consult the manual of your WAN device connected to your Dial Backup port for specific AT commands.
Edit Advanced Setup	To edit the advanced setup for the Dial Backup port, move the cursor to this field; press the [SPACE BAR] to select Yes and then press [ENTER] to go to Menu 2.1 - Advanced Setup .
When you have completed this menu, press [ENTER] at the prompt "Press ENTER to Confirm..." to save your configuration, or press [ESC] at any time to cancel.	

28.5 Advanced WAN Setup

Note: Consult the manual of your WAN device connected to your Dial Backup port for specific AT commands.

To edit the advanced setup for the Dial Backup port, move the cursor to the **Edit Advanced Setup** field in **Menu 2 - WAN Setup**, press the [SPACE BAR] to select **Yes** and then press [ENTER].

Figure 229 Menu 2.1: Advanced WAN Setup

```

Menu 2.1 - Advanced WAN Setup

AT Command Strings:
Dial= atdt
Drop= ~+~+~+~ath
Answer= ata

Drop DTR When Hang Up= Yes

AT Response Strings:
CLID= NMBR =
Called Id=
Speed= CONNECT

Call Control:
Dial Timeout(sec)= 60
Retry Count= 0
Retry Interval(sec)= N/A
Drop Timeout(sec)= 20
Call Back Delay(sec)= 15

Press ENTER to Confirm or ESC to Cancel:
    
```

The following table describes fields in this menu.

Table 163 Advanced WAN Port Setup: AT Commands Fields

FIELD	DESCRIPTION
AT Command Strings:	
Dial	Enter the AT Command string to make a call.
Drop	Enter the AT Command string to drop a call. "~" represents a one second wait, e.g., "~+~+~+~ath" can be used if your modem has a slow response time.
Answer	Enter the AT Command string to answer a call.
Drop DTR When Hang Up	Press the [SPACE BAR] to choose either Yes or No . When Yes is selected (the default), the DTR (Data Terminal Ready) signal is dropped after the "AT Command String: Drop" is sent out.
AT Response Strings:	
CLID (Calling Line Identification)	Enter the keyword that precedes the CLID (Calling Line Identification) in the AT response string. This lets the ZyWALL capture the CLID in the AT response string that comes from the WAN device. CLID is required for CLID authentication.
Called Id	Enter the keyword preceding the dialed number.
Speed	Enter the keyword preceding the connection speed.

Table 164 Advanced WAN Port Setup: Call Control Parameters

FIELD	DESCRIPTION
Call Control	
Dial Timeout (sec)	Enter a number of seconds for the ZyWALL to keep trying to set up an outgoing call before timing out (stopping). The ZyWALL times out and stops if it cannot set up an outgoing call within the timeout value.
Retry Count	Enter a number of times for the ZyWALL to retry a busy or no-answer phone number before blacklisting the number.
Retry Interval (sec)	Enter a number of seconds for the ZyWALL to wait before trying another call after a call has failed. This applies before a phone number is blacklisted.
Drop Timeout (sec)	Enter a number of seconds for the ZyWALL to wait before dropping the DTR signal if it does not receive a positive disconnect confirmation.
Call Back Delay (sec)	Enter a number of seconds for the ZyWALL to wait between dropping a callback request call and dialing the co-responding callback call.

28.6 Remote Node Profile (Backup ISP)

Enter **3** in **Menu 11 - Remote Node Setup** to open **Menu 11.3 - Remote Node Profile (Backup ISP)** (shown below) and configure the setup for your Dial Backup port connection.

Figure 230 Menu 11.3: Remote Node Profile (Backup ISP)

```

Menu 11.3 - Remote Node Profile (Backup ISP)

Rem Node Name=                               Edit PPP Options= No
Active= No                                     Edit IP= No
                                                Edit Script Options= No

Outgoing:
  My Login= ChangeMe
  My Password= *****
  Retype to Confirm= *****
  Authen= CHAP/PAP
  Pri Phone #= 0
  Sec Phone #=

Telco Option:
  Allocated Budget(min)= 0
  Period(hr)= 0
  Schedules=
  Always On= No

Session Options:
  Edit Filter Sets= No
  Idle Timeout(sec)= 100

Press ENTER to Confirm or ESC to Cancel:

```

The following table describes the fields in this menu.

Table 165 Menu 11.3: Remote Node Profile (Backup ISP)

FIELD	DESCRIPTION
Rem Node Name	Enter a descriptive name for the remote node. This field can be up to eight characters.
Active	Press [SPACE BAR] and then [ENTER] to select Yes to enable the remote node or No to disable the remote node.
Outgoing	
My Login	Enter the login name assigned by your ISP for this remote node.
My Password	Enter the password assigned by your ISP for this remote node.
Retype to Confirm	Enter your password again to make sure that you have entered is correctly.
Authen	This field sets the authentication protocol used for outgoing calls. Options for this field are: CHAP/PAP - Your ZyWALL will accept either CHAP or PAP when requested by this remote node. CHAP - accept CHAP only. PAP - accept PAP only.
Pri Phone # Sec Phone #	Enter the first (primary) phone number from the ISP for this remote node. If the Primary Phone number is busy or does not answer, your ZyWALL dials the Secondary Phone number if available. Some areas require dialing the pound sign # before the phone number for local calls. Include a # symbol at the beginning of the phone numbers as required.
Edit PPP Options	Move the cursor to this field and use the space bar to select [Yes] and press [Enter] to edit the PPP options for this remote node. This brings you to Menu 11.3.1 - Remote Node PPP Options (see Section 28.7 on page 435).
Edit IP	This field leads to a "hidden" menu. Press [SPACE BAR] to select Yes and press [ENTER] to go to Menu 11.3.2 - Remote Node Network Layer Options . See Section 28.8 on page 435 for more information.
Edit Script Options	Press [SPACE BAR] to select Yes and press [ENTER] to edit the AT script for the dial backup remote node (Menu 11.3.3 - Remote Node Script). See Section 28.9 on page 437 for more information.
Telco Option	
Allocated Budget	Enter the maximum number of minutes that this remote node may be called within the time period configured in the Period field. The default for this field is 0 meaning there is no budget control and no time limit for accessing this remote node.
Period(hr)	Enter the time period (in hours) for how often the budget should be reset. For example, to allow calls to this remote node for a maximum of 10 minutes every hour, set the Allocated Budget to 10 (minutes) and the Period to 1 (hour).
Schedules	You can apply up to four schedule sets here. For more details please refer to Chapter 44 on page 559 .
Always On	Press [SPACE BAR] to select Yes to set this connection to be on all the time, regardless of whether or not there is any traffic. Select No to have this connection act as a dial-up connection.
Session Options	
Edit Filter sets	This field leads to another "hidden" menu. Use [SPACE BAR] to select Yes and press [ENTER] to open menu 11.3.4 to edit the filter sets. See Section 28.10 on page 439 for more details.

Table 165 Menu 11.3: Remote Node Profile (Backup ISP) (continued)

FIELD	DESCRIPTION
Idle Timeout	Enter the number of seconds of idle time (when there is no traffic from the ZyWALL to the remote node) that can elapse before the ZyWALL automatically disconnects the PPP connection. This option only applies when the ZyWALL initiates the call.
Once you have configured this menu, press [ENTER] at the message "Press ENTER to Confirm..." to save your configuration, or press [ESC] at any time to cancel.	

28.7 Editing PPP Options

The ZyWALL's dial back-up feature uses PPP. To edit the remote node PPP Options, move the cursor to the **Edit PPP Options** field in **Menu 11.3 - Remote Node Profile (Backup ISP)**, and use the space bar to select **Yes**. Press [Enter] to open **Menu 11.3.1 - Remote Node PPP Options** as shown next.

Figure 231 Menu 11.3.1: Remote Node PPP Options

```

Menu 11.3.1 - Remote Node PPP Options

Encapsulation= Standard PPP
Compression= No

Enter here to CONFIRM or ESC to CANCEL:

```

This table describes the Remote Node PPP Options Menu, and contains instructions on how to configure the PPP options fields.

Table 166 Menu 11.3.1: Remote Node PPP Options

FIELD	DESCRIPTION
Encapsulation	Press [SPACE BAR] and then [ENTER] to select CISCO PPP if your Dial Backup WAN device uses Cisco PPP encapsulation, otherwise select Standard PPP .
Compression	Press [SPACE BAR] and then [ENTER] to select Yes to enable or No to disable Stac compression.
Once you have configured this menu, press [ENTER] at the message "Press ENTER to Confirm..." to save your configuration, or press [ESC] at any time to cancel.	

28.8 Editing TCP/IP Options

Move the cursor to the **Edit IP** field in menu 11.3, then press [SPACE BAR] to select **Yes**. Press [ENTER] to open **Menu 11.3.2 - Remote Node Network Layer Options**.

Figure 232 Menu 11.3.2: Remote Node Network Layer Options

```

Menu 11.3.2 - Remote Node Network Layer Options

IP Address Assignment= Static
Rem IP Addr= 0.0.0.0
Rem Subnet Mask= 0.0.0.0
My WAN Addr= 0.0.0.0

Network Address Translation= SUA Only
NAT Lookup Set= 255
Metric= 15
Private= No
RIP Direction= None
    Version= N/A
Multicast= None

Enter here to CONFIRM or ESC to CANCEL:
    
```

The following table describes the fields in this menu.

Table 167 Menu 11.3.2: Remote Node Network Layer Options

FIELD	DESCRIPTION
IP Address Assignment	If your ISP did not assign you a fixed IP address, press [SPACE BAR] and then [ENTER] to select Dynamic , otherwise select Static and enter the IP address and subnet mask in the following fields.
Rem IP Address	Enter the (fixed) IP address assigned to you by your ISP (static IP address assignment is selected in the previous field).
Rem Subnet Mask	Enter the subnet mask associated with your static IP.
My WAN Addr	Leave the field set to 0.0.0.0 to have the ISP or other remote router dynamically (automatically) assign your WAN IP address if you do not know it. Enter your WAN IP address here if you know it (static). This is the address assigned to your local ZyWALL, not the remote router.
Network Address Translation	Network Address Translation (NAT) allows the translation of an Internet protocol address used within one network (for example a private IP address used in a local network) to a different IP address known within another network (for example a public IP address used on the Internet). Press [SPACE BAR] and then [ENTER] to select either Full Feature , None or SUA Only . Choose None to disable NAT. Choose SUA Only if you have a single public IP address. SUA (Single User Account) is a subset of NAT that supports two types of mapping: Many-to-One and Server . Choose Full Feature if you have multiple public IP addresses. Full Feature mapping types include: One-to-One , Many-to-One (SUA/PAT), Many-to-Many Overload , Many- One-to-One and Server . When you select Full Feature you must configure at least one address mapping set. See Chapter 17 on page 297 for a full discussion on this feature.

Table 167 Menu 11.3.2: Remote Node Network Layer Options

FIELD	DESCRIPTION
NAT Lookup Set	If you select SUA Only in the Network Address Translation field, it displays 255 and indicates the SMT will use the pre-configured Set 255 (read only) in menu 15.1. If you select Full Feature or None in the Network Address Translation field, it displays 1 , 2 or 3 and indicates the SMT will use the pre-configured Set 1 in menu 15.1 for the first WAN port, Set 2 in menu 15.1 for the second WAN port and Set 3 for the Backup port. Refer to Section 35.2 on page 475 for more information.
Metric	Enter a number from 1 to 15 to set this route's priority among the ZyWALL's routes. The smaller the number, the higher priority the route has.
Private	This parameter determines if the ZyWALL will include the route to this remote node in its RIP broadcasts. If set to Yes , this route is kept private and not included in RIP broadcasts. If No , the route to this remote node will be propagated to other hosts through RIP broadcasts.
RIP Direction	Press [SPACE BAR] and then [ENTER] to select the RIP Direction from Both , None , In Only , Out Only and None .
Version	Press [SPACE BAR] and then [ENTER] to select the RIP version from RIP-1 , RIP-2B and RIP-2M .
Multicast	IGMP (Internet Group Multicast Protocol) is a session-layer protocol used to establish membership in a Multicast group. The ZyWALL supports both IGMP version 1 (IGMP-v1) and version 2 (IGMP-v2). Press the [SPACE BAR] to enable IP Multicasting or select None to disable it. See Chapter 4 on page 93 for more information on this feature.
Once you have completed filling in Menu 11.3.2 Remote Node Network Layer Options , press [ENTER] at the message "Press ENTER to Confirm..." to save your configuration and return to menu 11.3, or press [ESC] at any time to cancel.	

28.9 Editing Login Script

For some remote gateways, text login is required before PPP negotiation is started. The ZyWALL provides a script facility for this purpose. The script has six programmable sets; each set is composed of an 'Expect' string and a 'Send' string. After matching a message from the server to the 'Expect' field, the ZyWALL returns the set's 'Send' string to the server.

For instance, a typical login sequence starts with the server printing a banner, a login prompt for you to enter the user name and a password prompt to enter the password:

```
Welcome to Acme, Inc.
Login: myLogin
Password:
```

To handle the first prompt, you specify "ogin: " as the 'Expect' string and "myLogin" as the 'Send' string in set 1. The reason for leaving out the leading "L" is to avoid having to know exactly whether it is upper or lower case. Similarly, you specify "word: " as the 'Expect' string and your password as the 'Send' string for the second prompt in set 2.

You can use two variables, `$USERNAME` and `$PASSWORD` (all UPPER case), to represent the actual user name and password in the script, so they will not show in the clear. They are replaced with the outgoing login name and password in the remote node when the ZyWALL sees them in a 'Send' string. Please note that both variables must be entered exactly as shown. No other characters may appear before or after, either, i.e., they must be used alone in response to login and password prompts.

Please note that the ordering of the sets is significant, i.e., starting from set 1, the ZyWALL will wait until the 'Expect' string is matched before it proceeds to set 2, and so on for the rest of the script. When both the 'Expect' and the 'Send' fields of the current set are empty, the ZyWALL will terminate the script processing and start PPP negotiation. This implies two things: first, the sets must be contiguous; the sets after an empty one are ignored. Second, the last set should match the final message sent by the server. For instance, if the server prints:

```
login successful.  
Starting PPP...
```

after you enter the password, then you should create a third set to match the final "PPP . . ." but without a "Send" string. Otherwise, the ZyWALL will start PPP prematurely right after sending your password to the server.

If there are errors in the script and it gets stuck at a set for longer than the "Dial Timeout" in menu 2 (default 60 seconds), the ZyWALL will timeout and drop the line. To debug a script, go to Menu 24.4 to initiate a manual call and watch the trace display to see if the sequence of messages and prompts from the server differs from what you expect.

Figure 233 Menu 11.3.3: Remote Node Script

```
Menu 11.3.3 - Remote Node Script  
  
Active= No  
  
Set 1:                               Set 5:  
  Expect=                             Expect=  
  Send=                               Send=  
Set 2:                               Set 6:  
  Expect=                             Expect=  
  Send=                               Send=  
Set 3:  
  Expect=  
  Send=  
Set 4:  
  Expect=  
  Send=  
  
Enter here to CONFIRM or ESC to CANCEL:
```

The following table describes the fields in this menu.

Table 168 Menu 11.3.3: Remote Node Script

FIELD	DESCRIPTION
Active	Press [SPACE BAR] and then [ENTER] to select either Yes to enable the AT strings or No to disable them.
Set 1-6: Expect	Enter an Expect string to match. After matching the Expect string, the ZyWALL returns the string in the Send field.
Set 1-6: Send	Enter a string to send out after the Expect string is matched.

28.10 Remote Node Filter

Move the cursor to the field **Edit Filter Sets** in menu 11.3, and then press [SPACE BAR] to set the value to **Yes**. Press [ENTER] to open **Menu 11.3.4 - Remote Node Filter**.

Use menu 11.3.4 to specify the filter set(s) to apply to the incoming and outgoing traffic between this remote node and the ZyWALL to prevent certain packets from triggering calls. You can specify up to four filter sets separated by commas, for example, 1, 5, 9, 12, in each filter field. Note that spaces are accepted in this field. Please refer to [Chapter 37 on page 495](#) for more information on defining the filters.

Figure 234 Menu 11.3.4: Remote Node Filter

```

Menu 11.3.4 - Remote Node Filter

Input Filter Sets:
  protocol filters=
  device filters=
Output Filter Sets:
  protocol filters=
  device filters=
Call Filter Sets:
  protocol filters=
  device filters=

Enter here to CONFIRM or ESC to CANCEL:

```

CHAPTER 29

LAN Setup

This chapter describes how to configure the LAN using **Menu 3 - LAN Setup**.

29.1 Introduction to LAN Setup

This chapter describes how to configure the ZyWALL for LAN and wireless LAN connections.

29.2 Accessing the LAN Menus

From the main menu, enter 3 to open **Menu 3 - LAN Setup**.

Figure 235 Menu 3: LAN Setup

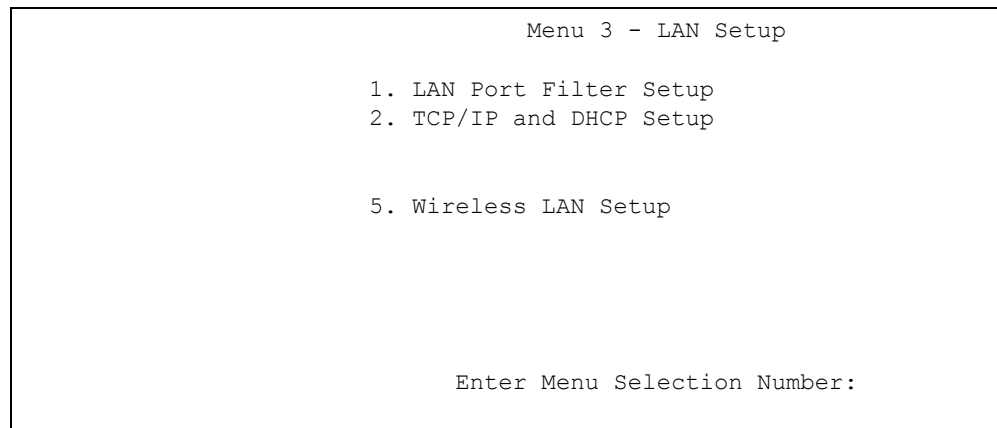

29.3 LAN Port Filter Setup

This menu allows you to specify the filter sets that you wish to apply to the LAN traffic. You seldom need to filter the LAN traffic, however, the filter sets may be useful to block certain packets, reduce traffic and prevent security breaches.

Figure 236 Menu 3.1: LAN Port Filter Setup

```
Menu 3.1 - LAN Port Filter Setup

Input Filter Sets:
  protocol filters=
  device filters=
Output Filter Sets:
  protocol filters=
  device filters=

Press ENTER to Confirm or ESC to Cancel:
```

29.4 TCP/IP and DHCP Ethernet Setup Menu

From the main menu, enter 3 to open **Menu 3 - LAN Setup** to configure TCP/IP (RFC 1155) and DHCP Ethernet setup.

Figure 237 Menu 3: TCP/IP and DHCP Setup

```
Menu 3 - LAN Setup

1. LAN Port Filter Setup
2. TCP/IP and DHCP Setup

5. Wireless LAN Setup

Enter Menu Selection Number:
```

From menu 3, select the submenu option **TCP/IP and DHCP Setup** and press [ENTER]. The screen now displays **Menu 3.2 - TCP/IP and DHCP Ethernet Setup**, as shown next.

Figure 238 Menu 3.2: TCP/IP and DHCP Ethernet Setup

```

Menu 3.2 - TCP/IP and DHCP Ethernet Setup

DHCP= Server          TCP/IP Setup:
Client IP Pool:
  Starting Address= 192.168.1.33  IP Address= 192.168.1.1
  Size of Client IP Pool= 128    IP Subnet Mask= 255.255.255.0
                                   RIP Direction= Both
                                   Version= RIP-1
                                   Multicast= None
                                   Edit IP Alias= No

DHCP Server Address= N/A

Press ENTER to Confirm or ESC to Cancel:

```

Follow the instructions in the next table on how to configure the DHCP fields.

Table 169 Menu 3.2: DHCP Ethernet Setup Fields

FIELD	DESCRIPTION
DHCP	This field enables/disables the DHCP server. If set to Server , your ZyWALL will act as a DHCP server. If set to None , the DHCP server will be disabled. If set to Relay , the ZyWALL acts as a surrogate DHCP server and relays requests and responses between the remote server and the clients. When set to Server , the following items need to be set:
Client IP Pool:	
Starting Address	This field specifies the first of the contiguous addresses in the IP address pool.
Size of Client IP Pool	This field specifies the size, or count of the IP address pool.
DHCP Server Address	If Relay is selected in the DHCP field above, then type the IP address of the actual, remote DHCP server here.

Use the instructions in the following table to configure TCP/IP parameters for the LAN port.

Note: LAN and DMZ IP addresses must be on separate subnets.

Table 170 Menu 3.2: LAN TCP/IP Setup Fields

FIELD	DESCRIPTION
TCP/IP Setup:	
IP Address	Enter the IP address of your ZyWALL in dotted decimal notation
IP Subnet Mask	Your ZyWALL will automatically calculate the subnet mask based on the IP address that you assign. Unless you are implementing subnetting, use the subnet mask computed by the ZyWALL.

Table 170 Menu 3.2: LAN TCP/IP Setup Fields (continued)

FIELD	DESCRIPTION
RIP Direction	Press [SPACE BAR] and then [ENTER] to select the RIP direction. Options are: Both, In Only, Out Only or None .
Version	Press [SPACE BAR] and then [ENTER] to select the RIP version. Options are: RIP-1, RIP-2B or RIP-2M .
Multicast	IGMP (Internet Group Multicast Protocol) is a session-layer protocol used to establish membership in a Multicast group. The ZyWALL supports both IGMP version 1 (IGMP-v1) and version 2 (IGMP-v2). Press [SPACE BAR] and then [ENTER] to enable IP Multicasting or select None (default) to disable it.
Edit IP Alias	The ZyWALL supports three logical LAN interfaces via its single physical Ethernet interface with the ZyWALL itself as the gateway for each LAN network. Press [SPACE BAR] to select Yes and then press [ENTER] to display menu 3.2.1
When you have completed this menu, press [ENTER] at the prompt [Press ENTER to Confirm...] to save your configuration, or press [ESC] at any time to cancel.	

29.4.1 IP Alias Setup

IP alias allows you to partition a physical network into different logical networks over the same Ethernet interface. The ZyWALL supports three logical LAN interfaces via its single physical Ethernet interface with the ZyWALL itself as the gateway for each LAN network.

You must use menu 3.2 to configure the first network. Move the cursor to the **Edit IP Alias** field, press [SPACE BAR] to choose **Yes** and press [ENTER] to configure the second and third network.

Press [ENTER] to open **Menu 3.2.1 - IP Alias Setup**, as shown next.

Figure 239 Menu 3.2.1: IP Alias Setup

```

Menu 3.2.1 - IP Alias Setup

IP Alias 1= Yes
  IP Address= 192.168.2.1
  IP Subnet Mask= 255.255.255.0
  RIP Direction= None
  Version= RIP-1
  Incoming protocol filters=
  Outgoing protocol filters=
IP Alias 2= No
  IP Address= N/A
  IP Subnet Mask= N/A
  RIP Direction= N/A
  Version= N/A
  Incoming protocol filters= N/A
  Outgoing protocol filters= N/A

Enter here to CONFIRM or ESC to CANCEL:

```

Use the instructions in the following table to configure IP alias parameters.

Table 171 Menu 3.2.1: IP Alias Setup

FIELD	DESCRIPTION
IP Alias 1, 2	Choose Yes to configure the LAN network for the ZyWALL.
IP Address	Enter the IP address of your ZyWALL in dotted decimal notation.
IP Subnet Mask	Your ZyWALL will automatically calculate the subnet mask based on the IP address that you assign. Unless you are implementing subnetting, use the subnet mask computed by the ZyWALL.
RIP Direction	Press [SPACE BAR] and then [ENTER] to select the RIP direction. Options are Both , In Only , Out Only or None .
Version	Press [SPACE BAR] and then [ENTER] to select the RIP version. Options are RIP-1 , RIP-2B or RIP-2M .
Incoming Protocol Filters	Enter the filter set(s) you wish to apply to the incoming traffic between this node and the ZyWALL.
Outgoing Protocol Filters	Enter the filter set(s) you wish to apply to the outgoing traffic between this node and the ZyWALL.
When you have completed this menu, press [ENTER] at the prompt [Press ENTER to Confirm...] to save your configuration, or press [ESC] at any time to cancel.	

29.5 Wireless LAN Setup

Use menu 3.5 to set up your ZyWALL as the wireless access point.

Note: If you are configuring the ZyWALL from a computer connected to the wireless LAN and you change the ZyWALL's ESSID or WEP settings, you will lose your wireless connection when you press [ENTER] to confirm. You must then change the wireless settings of your computer to match the ZyWALL's new settings.

From the main menu, enter 3 to open **Menu 3 - LAN Setup** to configure the Wireless LAN setup. To edit the wireless LAN configuration, enter 5 to open **Menu 3.5 - Wireless LAN Setup** as shown next.

Figure 240 Menu 3.5: Wireless LAN Setup

```

Menu 3.5 - Wireless LAN Setup

Enable Wireless LAN= No
ESSID= Wireless
Hide ESSID= No
Channel ID= CH06 2437MHz
RTS Threshold= 2432
Frag. Threshold= 2432
WEP= Disable
    Default Key= N/A
    Key1= N/A
    Key2= N/A
    Key3= N/A
    Key4= N/A
Edit MAC Address Filter= No

Press ENTER to Confirm or ESC to Cancel:
    
```

Note: The settings of all client stations on the wireless LAN must match those of the ZyWALL.

Follow the instructions in the next table on how to configure the wireless LAN parameters.

Table 172 Menu 3.5: Wireless LAN Setup

FIELD	DESCRIPTION
Enable Wireless LAN	Press [SPACE BAR] to select Yes to turn on the wireless LAN. The wireless LAN is off by default. Configure wireless LAN security features such as Mac filters and 802.1X before you turn on the wireless LAN.
ESSID	(Extended Service Set Identification) The ESSID identifies the AP to which the wireless stations associate. Wireless stations associating to the Access Point must have the same ESSID. Enter a descriptive name (up to 32 characters) for the wireless LAN.
Hide ESSID	Press [SPACE BAR] to select Yes to hide the ESSID in the outgoing beacon frame so a station cannot obtain the ESSID through passive scanning.
Channel ID	This allows you to set the operating frequency/channel depending on your particular region. Use the [SPACE BAR] to select a channel.

Table 172 Menu 3.5: Wireless LAN Setup

FIELD	DESCRIPTION
RTS Threshold	(Request To Send) The threshold (number of bytes) for enabling RTS/CTS handshake. Data with its frame size larger than this value will perform the RTS/CTS handshake. Setting this attribute to be larger than the maximum MSDU (MAC service data unit) size turns off the RTS/CTS handshake. Setting this attribute to zero turns on the RTS/CTS handshake. Enter a value between 0 and 2432 .
Frag. Threshold	The threshold (number of bytes) for the fragmentation boundary for directed messages. It is the maximum data fragment size that can be sent. Enter a value between 256 and 2432 .
WEP	Select Disable to allow wireless stations to communicate with the access points without any data encryption. Select 64-bit WEP or 128-bit WEP to enable data encryption.
Default Key	Enter the key number (1 to 4) in this field. Only one key can be enabled at any one time. This key must be the same on the ZyWALL and the wireless stations to communicate.
Key 1 to Key 4	The WEP keys are used to encrypt data. Both the ZyWALL and the wireless stations must use the same WEP key for data transmission. If you chose 64-bit WEP in the WEP Encryption field, then enter any 5 ASCII characters or 10 hexadecimal characters ("0-9", "A-F"). If you chose 128-bit WEP in the WEP Encryption field, then enter 13 ASCII characters or 26 hexadecimal characters ("0-9", "A-F"). Note: Enter "0x" before the key to denote a hexadecimal key. Don't enter "0x" before the key to denote an ASCII key.
Edit MAC Address Filter	Press [SPACE BAR] to select Yes and then press [ENTER] to display menu 3.5.1.
When you have completed this menu, press [ENTER] at the prompt "Press ENTER to Confirm..." to save your configuration, or press [ESC] at any time to cancel.	

Note: The ZyWALL LAN Ethernet and wireless ports can transparently communicate with each other (transparent bridge).

29.5.1 MAC Address Filter Setup

Your ZyWALL checks the MAC address of the wireless station device against a list of allowed or denied MAC addresses. However, intruders could fake allowed MAC addresses so MAC-based authentication is less secure than EAP authentication.

Follow the steps below to create the MAC address table on your ZyWALL.

- 1** From the main menu, enter 3 to open **Menu 3 - LAN Setup**.
- 2** Enter 5 to display **Menu 3.5 - Wireless LAN Setup**.
- 3** In the **Edit MAC Address Filter** field, press [SPACE BAR] to select **Yes** and press [ENTER]. **Menu 3.5.1 - WLAN MAC Address Filter** displays as shown next.

Figure 241 Menu 3.5.1: WLAN MAC Address Filter

```

Menu 3.5.1 - WLAN MAC Address Filter

Active= No
Filter Action= Allowed Association
MAC Address Filter
  Address 1= 00:00:00:00:00:00
  Address 2= 00:00:00:00:00:00
  Address 3= 00:00:00:00:00:00
  Address 4= 00:00:00:00:00:00
  Address 5= 00:00:00:00:00:00
  Address 6= 00:00:00:00:00:00
  Address 7= 00:00:00:00:00:00
  Address 8= 00:00:00:00:00:00
  Address 9= 00:00:00:00:00:00
  Address 10= 00:00:00:00:00:00
  Address 11= 00:00:00:00:00:00
  Address 12= 00:00:00:00:00:00

Enter here to CONFIRM or ESC to CANCEL:
    
```

The following table describes the fields in this menu.

Table 173 Menu 3.5.1: WLAN MAC Address Filter

FIELD	DESCRIPTION
Active	To enable MAC address filtering, press [SPACE BAR] to select Yes and press [ENTER].
Filter Action	Define the filter action for the list of MAC addresses in the MAC address filter table. To deny access to the ZyWALL, press [SPACE BAR] to select Deny Association and press [ENTER]. MAC addresses not listed will be allowed to access the router. The default action, Allowed Association , permits association with the ZyWALL. MAC addresses not listed will be denied access to the router.
MAC Address Filter	
Address 1..12	Enter the MAC addresses (in XX:XX:XX:XX:XX:XX format) of the client computers that are allowed or denied access to the ZyWALL in these address fields.
When you have completed this menu, press [ENTER] at the prompt [Press ENTER to Confirm...] to save your configuration, or press [ESC] at any time to cancel.	

CHAPTER 30

Internet Access

This chapter shows you how to configure your ZyWALL for Internet access.

30.1 Introduction to Internet Access Setup

Use information from your ISP along with the instructions in this chapter to set up your ZyWALL to access the Internet. There are three different menu 4 screens depending on whether you chose **Ethernet**, **PPTP** or **PPPoE** Encapsulation. Contact your ISP to determine what encapsulation type you should use.

30.2 Ethernet Encapsulation

If you choose **Ethernet** in menu 4 you will see the next menu.

Figure 242 Menu 4: Internet Access Setup (Ethernet)

```
Menu 4 - Internet Access Setup

ISP's Name= WAN_1
Encapsulation= Ethernet
  Service Type= Standard
  My Login= N/A
  My Password= N/A
  Retype to Confirm= N/A
  Login Server= N/A
  Relogin Every (min)= N/A
IP Address Assignment= Dynamic
  IP Address= N/A
  IP Subnet Mask= N/A
  Gateway IP Address= N/A
Network Address Translation= SUA Only

Press ENTER to Confirm or ESC to Cancel:
```

The following table describes the fields in this menu.

Table 174 Menu 4: Internet Access Setup (Ethernet)

FIELD	DESCRIPTION
ISP's Name	This is the descriptive name of your ISP for identification purposes. You can only configure the WAN 2 port in Menu 11.2 - Remote Node Profile or in the WAN WAN 2 screen via the web configurator.
Encapsulation	Press [SPACE BAR] and then press [ENTER] to choose Ethernet . The encapsulation method influences your choices for the IP Address field.
Service Type	Press [SPACE BAR] and then [ENTER] to select Standard , RR-Toshiba (RoadRunner Toshiba authentication method), RR-Manager (RoadRunner Manager authentication method), RR-Telstra or Telia Login . Choose a RoadRunner flavor if your ISP is Time Warner's RoadRunner; otherwise choose Standard .
Note: DSL users must choose the Standard option only. The My Login , My Password and Login Server fields are not applicable in this case.	
My Login	Enter the login name given to you by your ISP.
My Password	Type your password again for confirmation.
Retype to Confirm	Enter your password again to make sure that you have entered is correctly.
Login Server	The ZyWALL will find the RoadRunner Server IP if this field is left blank. If it does not, then you must enter the authentication server IP address.
Relogin Every (min)	This field is available when you select Telia Login in the Service Type field. The Telia server logs the ZyWALL out if the ZyWALL does not log in periodically. Type the number of minutes from 1 to 59 (30 recommended) for the ZyWALL to wait between logins.
IP Address Assignment	If your ISP did not assign you a fixed IP address, press [SPACE BAR] and then [ENTER] to select Dynamic , otherwise select Static and enter the IP address and subnet mask in the following fields.
IP Address	Enter the (fixed) IP address assigned to you by your ISP (static IP address assignment is selected in the previous field).
IP Subnet Mask	Enter the subnet mask associated with your static IP.
Gateway IP Address	Enter the gateway IP address associated with your static IP.
Network Address Translation	Network Address Translation (NAT) allows the translation of an Internet protocol address used within one network (for example a private IP address used in a local network) to a different IP address known within another network (for example a public IP address used on the Internet). Choose None to disable NAT. Choose SUA Only if you have a single public IP address. SUA (Single User Account) is a subset of NAT that supports two types of mapping: Many-to-One and Server . Choose Full Feature if you have multiple public IP addresses. Full Feature mapping types include: One-to-One , Many-to-One (SUA/PAT), Many-to-Many Overload , Many- One-to-One and Server . When you select Full Feature you must configure at least one address mapping set! Please see Chapter 17 on page 297 for a more detailed discussion on the Network Address Translation feature.
When you have completed this menu, press [ENTER] at the prompt "Press ENTER to Confirm..." to save your configuration, or press [ESC] at any time to cancel.	

30.3 Configuring the PPTP Client

Note: The ZyWALL supports only one PPTP server connection at any given time.

To configure a PPTP client, you must configure the **My Login** and **Password** fields for a PPP connection and the PPTP parameters for a PPTP connection.

After configuring **My Login** and **Password** for PPP connection, press [SPACE BAR] and then [ENTER] in the **Encapsulation** field in **Menu 4 -Internet Access Setup** to choose **PPTP** as your encapsulation option. This brings up the following screen.

Figure 243 Internet Access Setup (PPTP)

```

Menu 4 - Internet Access Setup

ISP's Name= WAN_1
Encapsulation= PPTP
Service Type= N/A
My Login=
My Password= *****
Retype to Confirm= *****
Idle Timeout= 100

IP Address Assignment= Dynamic
IP Address= N/A
IP Subnet Mask= N/A
Gateway IP Address= N/A
Network Address Translation= SUA Only

Press ENTER to Confirm or ESC to Cancel:

```

The following table contains instructions about the new fields when you choose **PPTP** in the **Encapsulation** field in menu 4.

Table 175 New Fields in Menu 4 (PPTP) Screen

FIELD	DESCRIPTION
Encapsulation	Press [SPACE BAR] and then press [ENTER] to choose PPTP . The encapsulation method influences your choices for the IP Address field.
Idle Timeout	This value specifies the time, in seconds, that elapses before the ZyWALL automatically disconnects from the PPTP server.

30.4 Configuring the PPPoE Client

If you enable PPPoE in menu 4, you will see the next screen. For more information on PPPoE, please see [Appendix E on page 603](#).

Figure 244 Internet Access Setup (PPPoE)

```

Menu 4 - Internet Access Setup

ISP's Name= WAN_1
Encapsulation= PPPoE
Service Type= N/A
My Login=
My Password= *****
Retype to Confirm= *****
Idle Timeout= 100

IP Address Assignment= Dynamic
IP Address= N/A
IP Subnet Mask= N/A
Gateway IP Address= N/A
Network Address Translation= SUA Only

Press ENTER to Confirm or ESC to Cancel:
    
```

The following table contains instructions about the new fields when you choose **PPPoE** in the **Encapsulation** field in menu 4.

Table 176 New Fields in Menu 4 (PPPoE) screen

FIELD	DESCRIPTION
Encapsulation	Press [SPACE BAR] and then press [ENTER] to choose PPPoE . The encapsulation method influences your choices in the IP Address field.
Idle Timeout	This value specifies the time in seconds that elapses before the ZyWALL automatically disconnects from the PPPoE server.

If you need a PPPoE service name to identify and reach the PPPoE server, please go to menu 11 and enter the PPPoE service name provided to you in the **Service Name** field.

30.5 Basic Setup Complete

Well done! You have successfully connected, installed and set up your ZyWALL to operate on your network as well as access the Internet.

Note: When the firewall is activated, the default policy allows all communications to the Internet that originate from the LAN, and blocks all traffic to the LAN that originates from the Internet.

You may deactivate the firewall in menu 21.2 or via the ZyWALL embedded web configurator. You may also define additional firewall rules or modify existing ones but please exercise extreme caution in doing so. See the chapters on firewall for more information on the firewall.

CHAPTER 31

DMZ Setup

This chapter describes how to configure the ZyWALL's DMZ using **Menu 5 - DMZ Setup**.

31.1 Configuring DMZ Setup

From the main menu, enter 5 to open **Menu 5 – DMZ Setup**.

Figure 245 Menu 5: DMZ Setup

```
Menu 5 - DMZ Setup

1. DMZ Port Filter Setup
2. TCP/IP Setup

Enter Menu Selection Number:
```

31.2 DMZ Port Filter Setup

This menu allows you to specify the filter sets that you wish to apply to your public server(s) traffic.

Figure 246 Menu 5.1: DMZ Port Filter Setup

```
Menu 5.1 - DMZ Port Filter Setup

Input Filter Sets:
  protocol filters=
  device filters=
Output Filter Sets:
  protocol filters=
  device filters=

Press ENTER to Confirm or ESC to Cancel:
```

31.3 TCP/IP Setup

For more detailed information about RIP setup, IP Multicast and IP alias, please refer to [Chapter 4 on page 93](#).

31.3.1 IP Address

From the main menu, enter 5 to open **Menu 5 - DMZ Setup** to configure TCP/IP (RFC 1155).

Figure 247 Menu 5: TCP/IP Setup

```
Menu 5 - DMZ Setup

1. DMZ Port Filter Setup
2. TCP/IP Setup

Enter Menu Selection Number:
```

From menu 5, select the submenu option **2. TCP/IP Setup** and press [ENTER]. The screen now displays **Menu 5.2 - TCP/IP Setup**, as shown next.

Figure 248 Menu 5.2: TCP/IP Setup

```
Menu 5.2 - TCP/IP Ethernet Setup

TCP/IP Setup:
IP Address= 0.0.0.0
IP Subnet Mask= 0.0.0.0
RIP Direction= Both
Version= RIP-1
Multicast= None
Edit IP Alias= No

Press ENTER to Confirm or ESC to Cancel:
```

The TCP/IP setup fields are the same as the ones in **Menu 3.2 - TCP/IP Ethernet Setup**. Each public server will need a unique IP address. Refer to [Section 29.4 on page 442](#) for information on how to configure these fields.

Note: DMZ and LAN IP addresses must be on separate subnets. You must also configure NAT for the DMZ port (see [Chapter 35 on page 473](#)) in menus 15.1 and 15.2.

31.3.2 IP Alias Setup

You must use menu 5.2 to configure the first network. Move the cursor to the **Edit IP Alias** field, press [SPACE BAR] to choose **Yes** and press [ENTER] to configure the second and third network.

Pressing [ENTER] opens **Menu 5.2.1 - IP Alias Setup**, as shown next.

Figure 249 Menu 5.2.1: IP Alias Setup

```
Menu 5.2.1 - IP Alias Setup

IP Alias 1= No
  IP Address= N/A
  IP Subnet Mask= N/A
  RIP Direction= N/A
  Version= N/A
  Incoming protocol filters= N/A
  Outgoing protocol filters= N/A
IP Alias 2= No
  IP Address= N/A
  IP Subnet Mask= N/A
  RIP Direction= N/A
  Version= N/A
  Incoming protocol filters= N/A
  Outgoing protocol filters= N/A

Enter here to CONFIRM or ESC to CANCEL:
```

Refer to [Table 171 on page 445](#) for instructions on configuring IP alias parameters.

CHAPTER 32

Route Setup

This chapter describes how to configure the ZyWALL's traffic redirect.

32.1 Configuring Route Setup

From the main menu, enter 6 to open **Menu 6 - Route Setup**.

Figure 250 Menu 6: Route Setup

```
Menu 6 - Route Setup

1. Route Assessment
2. Traffic Redirect
3. Route Failover

Enter Menu Selection Number:
```

32.2 Route Assessment

This menu allows you to configure traffic redirect properties.

Figure 251 Menu 6.1: Route Assessment

```
Menu 6.1 - Route Assessment

Probing WAN 1 Check Point= Yes
  Use Default Gateway as Check Point= Yes
  Check Point= N/A
Probing WAN 2 Check Point= Yes
  Use Default Gateway as Check Point= Yes
  Check Point= N/A
Probing Traffic Redirection Check Point= No
  Use Default Gateway as Check Point= N/A
  Check Point= N/A

Press ENTER to Confirm or ESC to Cancel:
```

The following table describes the fields in this menu.

Table 177 Menu 6.1: Route Assessment

FIELD	DESCRIPTION
Probing WAN 1/2 Check Point	Press [SPACE BAR] and then press [ENTER] to choose Yes to test your ZyWALL's WAN accessibility. If you do not select No in the Use Default Gateway as Check Point field and enter a domain name or IP address of a reliable nearby computer (for example, your ISP's DNS server address) in the Check Point field, the ZyWALL will use the default gateway IP address.
Probing Traffic Redirection Check Point	Press [SPACE BAR] and then press [ENTER] to choose Yes to test your ZyWALL's traffic redirect connection. If you do not select No in the Use Default Gateway as Check Point field and enter a domain name or IP address of a reliable nearby computer (for example, your ISP's DNS server address) in the Check Point field, the ZyWALL will use the default gateway IP address.
When you have completed this menu, press [ENTER] at the prompt "Press ENTER to Confirm..." to save your configuration, or press [ESC] at any time to cancel.	

32.3 Traffic Redirect

To configure the parameters for traffic redirect, enter **2** in **Menu 6 - Route Setup** to open **Menu 6.2 - Traffic Redirect** as shown next.

Figure 252 Menu 6.2: Traffic Redirect

```

Menu 6.2 - Traffic Redirect

Active= No
Configuration:
Backup Gateway IP Address= 0.0.0.0
Metric= 14

Press ENTER to Confirm or ESC to Cancel:
    
```

The following table describes the fields in this menu.

Table 178 Menu 6.2: Traffic Redirect

FIELD	DESCRIPTION
Active	Press [SPACE BAR] and select Yes (to enable) or No (to disable) traffic redirect setup. The default is No.
Backup Gateway IP Address	Enter the IP address of your backup gateway in dotted decimal notation. The ZyWALL automatically forwards traffic to this IP address if the ZyWALL's Internet connection terminates.

Table 178 Menu 6.2: Traffic Redirect

FIELD	DESCRIPTION
Metric	This field sets this route's priority among the routes the ZyWALL uses. Enter a number from 1 to 15 to set this route's priority among the ZyWALL's routes (see Section 7.5 on page 135) The smaller the number, the higher priority the route has.
When you have completed this menu, press [ENTER] at the prompt "Press ENTER to Confirm..." to save your configuration, or press [ESC] at any time to cancel.	

32.4 Route Failover

This menu allows you to configure how the ZyWALL uses the route assessment ping check function.

Figure 253 Menu 6.3: Route Failover

```

Menu 6.3 - Route Failover

Period= 5
Timeout=: 3
Fail Tolerance= 3

Press ENTER to Confirm or ESC to Cancel:

```

The following table describes the fields in this menu.

Table 179 Menu 6.3: Route Failover

FIELD	DESCRIPTION
Period	Type the number of seconds for the ZyWALL to wait between checks to see if it can connect to the WAN IP address (in the Check Point field of menu 6.1) or the default gateway. Allow more time if your destination IP address handles lots of traffic.
Timeout	Type the number of seconds for your ZyWALL to wait for a ping response from the IP address in the Check Point field of menu 6.1 before it times out. The WAN connection is considered "down" after the ZyWALL times out the number of times specified in the Fail Tolerance field. Use a higher value in this field if your network is busy or congested.
Fail Tolerance	Type the number of times your ZyWALL may attempt and fail to connect to the Internet before traffic is forwarded to the backup gateway.
When you have completed this menu, press [ENTER] at the prompt "Press ENTER to Confirm..." to save your configuration, or press [ESC] at any time to cancel.	

CHAPTER 33

Remote Node Setup

This chapter shows you how to configure a remote node.

33.1 Introduction to Remote Node Setup

A remote node is required for placing calls to a remote gateway. A remote node represents both the remote gateway and the network behind it across a WAN connection. Note that when you use menu 4 to set up Internet access, you are actually configuring a remote node. The following describes how to configure **Menu 11.x (where x is 1 or 2) - Remote Node Profile**, **Menu 11.x.2 - Remote Node Network Layer Options** and **Menu 11.x.4 - Remote Node Filter**.

33.2 Remote Node Setup

From the main menu, select menu option 11 to open **Menu 11 - Remote Node Setup** (shown below).

Then enter **1** or **2** to open **Menu 11.x - Remote Node Profile** and configure the setup for your first or second WAN port. Enter **3** to open **Menu 11.3 Remote Node Profile (Backup ISP)** and configure the setup for your Dial Backup port connection (see [Chapter 28 on page 429](#)).

Figure 254 Menu 11: Remote Node Setup

```
Menu 11 - Remote Node Setup

1. WAN_1 (ISP, SUA)
2. WAN_2 (ISP, NAT)
3. -Dial (BACKUP_ISP, SUA)

Enter Node # to Edit:
```

33.3 Remote Node Profile Setup

The following explains how to configure the remote node profile menu.

33.3.1 Ethernet Encapsulation

There are three variations of menu 11.x depending on whether you choose **Ethernet Encapsulation**, **PPPoE Encapsulation** or **PPTP Encapsulation**. You must choose the **Ethernet** option when the WAN port is used as a regular Ethernet. The first menu 11.x screen you see is for Ethernet encapsulation shown next.

Figure 255 Menu 11.1: Remote Node Profile for Ethernet Encapsulation

```

Menu 11.1 - Remote Node Profile

Rem Node Name= WAN_1                Route= IP
Active= Yes

Encapsulation= Ethernet             Edit IP= No
Service Type= Standard              Session Options:
                                     Edit Filter Sets= No

Outgoing:
My Login= N/A
My Password= N/A
Retype to Confirm= N/A
Server= N/A
Relogin Every (min)= N/A

Press ENTER to Confirm or ESC to Cancel:

```

The following table describes the fields in this menu.

Table 180 Menu 11.1: Remote Node Profile for Ethernet Encapsulation

FIELD	DESCRIPTION
Rem Node Name	Enter a descriptive name for the remote node. This field can be up to eight characters.
Active	Press [SPACE BAR] and then [ENTER] to select Yes (activate remote node) or No (deactivate remote node).
Encapsulation	Ethernet is the default encapsulation. Press [SPACE BAR] and then [ENTER] to change to PPPoE or PPTP encapsulation.
Service Type	Press [SPACE BAR] and then [ENTER] to select from Standard , RR-Toshiba (RoadRunner Toshiba authentication method), RR-Manager (RoadRunner Manager authentication method), RR-Telstra or Telia Login . Choose one of the RoadRunner methods if your ISP is Time Warner's RoadRunner; otherwise choose Standard .
Outgoing	
My Login	This field is applicable for PPPoE encapsulation only. Enter the login name assigned by your ISP when the ZyWALL calls this remote node. Some ISPs append this field to the Service Name field above (e.g., jim@poelc) to access the PPPoE server.
My Password	Enter the password assigned by your ISP when the ZyWALL calls this remote node. Valid for PPPoE encapsulation only.

Table 180 Menu 11.1: Remote Node Profile for Ethernet Encapsulation (continued)

FIELD	DESCRIPTION
Retype to Confirm	Type your password again to make sure that you have entered it correctly.
Server	This field is valid only when RoadRunner is selected in the Service Type field. The ZyWALL will find the RoadRunner Server IP automatically if this field is left blank. If it does not, then you must enter the authentication server IP address here.
Relogin Every (min)	This field is available when you select Telia Login in the Service Type field. The Telia server logs the ZyWALL out if the ZyWALL does not log in periodically. Type the number of minutes from 1 to 59 (30 recommended) for the ZyWALL to wait between logins.
Route	This field refers to the protocol that will be routed by your ZyWALL – IP is the only option for the ZyWALL.
Edit IP	This field leads to a “hidden” menu. Press [SPACE BAR] to select Yes and press [ENTER] to go to Menu 11.x.2 - Remote Node Network Layer Options .
Session Options	
Edit Filter Sets	This field leads to another “hidden” menu. Use [SPACE BAR] to select Yes and press [ENTER] to open menu 11.x.4 to edit the filter sets. See Section 33.5 on page 468 for more details.
Once you have configured this menu, press [ENTER] at the message “Press ENTER to Confirm...” to save your configuration, or press [ESC] at any time to cancel.	

33.3.2 PPPoE Encapsulation

The ZyWALL supports PPPoE (Point-to-Point Protocol over Ethernet). You can only use PPPoE encapsulation when you're using the ZyWALL with a DSL modem as the WAN device. If you change the Encapsulation to **PPPoE**, then you will see the next screen. Please see [Appendix E on page 603](#) for more information on PPPoE.

Figure 256 Menu 11.1: Remote Node Profile for PPPoE Encapsulation

```
Menu 11.1 - Remote Node Profile

Rem Node Name= ChangeMe           Route= IP
Active= Yes

Encapsulation= PPPoE              Edit IP= No
Service Type= Standard            Telco Option:
Service Name=                     Allocated Budget(min)= 0
Outgoing:                          Period(hr)= 0
  My Login=                        Schedules=
  My Password= *****            Nailed-Up Connection= No
  Retype to Confirm= *****
  Authen= CHAP/PAP

                                   Session Options:
                                   Edit Filter Sets= No
                                   Idle Timeout(sec)= 100

                                   Press ENTER to Confirm or ESC to Cancel:
```

33.3.2.1 Outgoing Authentication Protocol

Generally speaking, you should employ the strongest authentication protocol possible, for obvious reasons. However, some vendor's implementation includes a specific authentication protocol in the user profile. It will disconnect if the negotiated protocol is different from that in the user profile, even when the negotiated protocol is stronger than specified. If you encounter a case where the peer disconnects right after a successful authentication, please make sure that you specify the correct authentication protocol when connecting to such an implementation.

33.3.2.2 Nailed-Up Connection

A nailed-up connection is a dial-up line where the connection is always up regardless of traffic demand. The ZyWALL does two things when you specify a nailed-up connection. The first is that idle timeout is disabled. The second is that the ZyWALL will try to bring up the connection when turned on and whenever the connection is down. A nailed-up connection can be very expensive for obvious reasons.

Do not specify a nailed-up connection unless your telephone company offers flat-rate service or you need a constant connection and the cost is of no concern.

The following table describes the fields not already described in [Table 180 on page 462](#).

33.3.2.3 Metric

See [Section 7.5 on page 135](#) for details on the **Metric** field.

Table 181 Fields in Menu 11.1 (PPPoE Encapsulation Specific)

FIELD	DESCRIPTION
Service Name	If you are using PPPoE encapsulation, then type the name of your PPPoE service here. Only valid with PPPoE encapsulation.
Authen	This field sets the authentication protocol used for outgoing calls. Options for this field are: CHAP/PAP - Your ZyWALL will accept either CHAP or PAP when requested by this remote node. CHAP - accept CHAP only. PAP - accept PAP only.
Telco Option	
Allocated Budget	The field sets a ceiling for outgoing call time for this remote node. The default for this field is 0 meaning no budget control.
Period(hr)	This field is the time period that the budget should be reset. For example, if we are allowed to call this remote node for a maximum of 10 minutes every hour, then the Allocated Budget is (10 minutes) and the Period(hr) is 1 (hour).
Schedules	You can apply up to four schedule sets here. For more details please refer to Chapter 44 on page 559 .
Nailed-Up Connection	This field specifies if you want to make the connection to this remote node a nailed-up connection. More details are given earlier in this section.
Session Options	
Idle Timeout	Type the length of idle time (when there is no traffic from the ZyWALL to the remote node) in seconds that can elapse before the ZyWALL automatically disconnects the PPPoE connection. This option only applies when the ZyWALL initiates the call.

33.3.3 PPTP Encapsulation

If you change the Encapsulation to **PPTP** in menu 11.1, then you will see the next screen. Please see [Appendix F on page 605](#) for information on PPTP.

Figure 257 Menu 11.1: Remote Node Profile for PPTP Encapsulation

```

Menu 11.1 - Remote Node Profile

Rem Node Name= ChangeMe           Route= IP
Active= Yes

Encapsulation= PPTP               Edit IP= No
Service Type= Standard            Telco Option:
                                   Allocated Budget(min)= 0
                                   Period(hr)= 0
                                   Schedules=
Outgoing:                          Nailed-Up Connection= No
  My Login=
  My Password= *****
  Retype to Confirm= *****
  Authen= CHAP/PAP
PPTP:                               Session Options:
  My IP Addr= 10.0.0.140           Edit Filter Sets= No
  My IP Mask= 255.255.255.0       Idle Timeout(sec)= 100
  Server IP Addr= 10.0.0.138
  Connection ID/Name=

                                   Press ENTER to Confirm or ESC to Cancel:

```

The next table shows how to configure fields in menu 11.1 not previously discussed.

Table 182 Menu 11.1: Remote Node Profile for PPTP Encapsulation

FIELD	DESCRIPTION
Encapsulation	Press [SPACE BAR] and then [ENTER] to select PPTP . You must also go to menu 11.3 to check the IP Address setting once you have selected the encapsulation method.
My IP Addr	Enter the IP address of the WAN Ethernet port.
My IP Mask	Enter the subnet mask of the WAN Ethernet port.
Server IP Addr	Enter the IP address of the ANT modem.
Connection ID/ Name	Enter the connection ID or connection name in the ANT. It must follow the "c:id" and "n:name" format. This field is optional and depends on the requirements of your DSL modem.
Schedules	You can apply up to four schedule sets here. For more details refer to Chapter 44 on page 559 .
Nailed-Up Connections	Press [SPACE BAR] and then [ENTER] to select Yes if you want to make the connection to this remote node a nailed-up connection.

33.4 Edit IP

Move the cursor to the **Edit IP** field in menu 11.1, then press [SPACE BAR] to select **Yes**. Press [ENTER] to open **Menu 11.1.2 - Remote Node Network Layer Options**.

Figure 258 Menu 11.1.2: Remote Node Network Layer Options for Ethernet Encapsulation

```

Menu 11.1.2 - Remote Node Network Layer Options

IP Address Assignment= Dynamic
Rem IP Addr= N/A
Rem Subnet Mask= N/A
My WAN Addr= N/A

Network Address Translation= SUA Only
NAT Lookup Set= 255
Metric= 1
Private= No
RIP Direction= None
  Version= N/A
Multicast= None

Enter here to CONFIRM or ESC to CANCEL:

```

This menu displays the **My WAN Addr** field for **PPPoE** and **PPTP** encapsulations and **Gateway IP Addr** field for **Ethernet** encapsulation. The following table describes the fields in this menu.

Table 183 Remote Node Network Layer Options Menu Fields

FIELD	DESCRIPTION
IP Address Assignment	If your ISP did not assign you an explicit IP address, press [SPACE BAR] and then [ENTER] to select Dynamic ; otherwise select Static and enter the IP address & subnet mask in the following fields.
(Rem) IP Address	If you have a static IP Assignment, enter the IP address assigned to you by your ISP.
(Rem) IP Subnet Mask	If you have a static IP Assignment, enter the subnet mask assigned to you.
Gateway IP Addr	This field is applicable to Ethernet encapsulation only. Enter the gateway IP address assigned to you if you are using a static IP address.
My WAN Addr	This field is applicable to PPPoE and PPTP encapsulations only. Some implementations, especially the UNIX derivatives, require the WAN link to have a separate IP network number from the LAN and each end must have a unique address within the WAN network number. If this is the case, enter the IP address assigned to the WAN port of your ZyWALL. Note that this is the address assigned to your local ZyWALL, not the remote router.
Network Address Translation	Network Address Translation (NAT) allows the translation of an Internet protocol address used within one network (for example a private IP address used in a local network) to a different IP address known within another network (for example a public IP address used on the Internet). Choose None to disable NAT. Choose SUA Only if you have a single public IP address. SUA (Single User Account) is a subset of NAT that supports two types of mapping: Many-to-One and Server . Choose Full Feature if you have multiple public IP addresses. Full Feature mapping types include: One-to-One , Many-to-One (SUA/PAT), Many-to-Many Overload , Many- One-to-One and Server . When you select Full Feature you must configure at least one address mapping set. See Chapter 17 on page 297 for a full discussion on this feature.

Table 183 Remote Node Network Layer Options Menu Fields (continued)

FIELD	DESCRIPTION
NAT Lookup Set	If you select SUA Only in the Network Address Translation field, it displays 255 and indicates the SMT will use the pre-configured Set 255 (read only) in menu 15.1. If you select Full Feature or None in the Network Address Translation field, it displays 1 , 2 or 3 and indicates the SMT will use the pre-configured Set 1 in menu 15.1 for the first WAN port, Set 2 in menu 15.1 for the second WAN port and Set 3 for the Backup port. Refer to Section 35.2 on page 475 for more information.
Metric	Enter a number from 1 to 15 to set this route's priority among the ZyWALL's routes (see Section 7.5 on page 135). The smaller the number, the higher priority the route has.
Private	This field is valid only for PPTP/PPPoE encapsulation. This parameter determines if the ZyWALL will include the route to this remote node in its RIP broadcasts. If set to Yes , this route is kept private and not included in RIP broadcast. If No , the route to this remote node will be propagated to other hosts through RIP broadcasts.
RIP Direction	Press [SPACE BAR] and then [ENTER] to select the RIP direction from Both/ None/In Only/Out Only . See Chapter 4 on page 93 for more information on RIP. The default for RIP on the WAN side is None . It is recommended that you do not change this setting.
Version	Press [SPACE BAR] and then [ENTER] to select the RIP version from RIP-1/RIP-2B/RIP-2M or None .
Multicast	IGMP (Internet Group Multicast Protocol) is a network-layer protocol used to establish membership in a Multicast group. The ZyWALL supports both IGMP version 1 (IGMP-v1) and version 2 (IGMP-v2). Press [SPACE BAR] to enable IP Multicasting or select None to disable it. See Chapter 4 on page 93 for more information on this feature.
Once you have completed filling in Menu 11.3 Remote Node Network Layer Options , press [ENTER] at the message "Press ENTER to Confirm..." to save your configuration and return to menu 11, or press [ESC] at any time to cancel.	

33.5 Remote Node Filter

Move the cursor to the field **Edit Filter Sets** in menu 11.1, and then press [SPACE BAR] to set the value to **Yes**. Press [ENTER] to open **Menu 11.1.4 - Remote Node Filter**.

Use menu 11.1.4 to specify the filter set(s) to apply to the incoming and outgoing traffic between this remote node and the ZyWALL to prevent certain packets from triggering calls. You can specify up to 4 filter sets separated by commas, for example, 1, 5, 9, 12, in each filter field. Note that spaces are accepted in this field. For more information on defining the filters, please refer to [Chapter 37 on page 495](#). For PPPoE or PPTP encapsulation, you have the additional option of specifying remote node call filter sets.

Figure 259 Menu 11.1.4: Remote Node Filter (Ethernet Encapsulation)

```
Menu 11.1.4 - Remote Node Filter

Input Filter Sets:
  protocol filters=
  device filters=
Output Filter Sets:
  protocol filters=
  device filters=

Enter here to CONFIRM or ESC to CANCEL:
```

Figure 260 Menu 11.1.4: Remote Node Filter (PPPoE or PPTP Encapsulation)

```
Menu 11.1.4 - Remote Node Filter

Input Filter Sets:
  protocol filters=
  device filters=
Output Filter Sets:
  protocol filters=
  device filters=
Call Filter Sets:
  protocol filters=
  device filters=

Enter here to CONFIRM or ESC to CANCEL:
```

CHAPTER 34

IP Static Route Setup

This chapter shows you how to configure static routes with your ZyWALL.

34.1 IP Static Route Setup

Enter 12 from the main menu. Select one of the IP static routes as shown next to configure IP static routes in menu 12.1.

Note: The first two static route entries are for default WAN1 and WAN2 routes and cannot be modified or deleted. The name of each default static route is left blank unless you configure a static WAN IP address. The route name changes from “default” to “-default” after you change the static WAN IP address to a dynamic WAN IP address, indicating the static route is inactive.

Figure 261 Menu 12: IP Static Route Setup

Menu 12 - IP Static Route Setup			
1. Reserved	16. _____	31. _____	46. _____
2. Reserved	17. _____	32. _____	47. _____
3. _____	18. _____	33. _____	48. _____
4. _____	19. _____	34. _____	49. _____
5. _____	20. _____	35. _____	50. _____
6. _____	21. _____	36. _____	
7. _____	22. _____	37. _____	
8. _____	23. _____	38. _____	
9. _____	24. _____	39. _____	
10. _____	25. _____	40. _____	
11. _____	26. _____	41. _____	
12. _____	27. _____	42. _____	
13. _____	28. _____	43. _____	
14. _____	29. _____	44. _____	
15. _____	30. _____	45. _____	

Enter selection number:

Now, enter the index number of the static route that you want to configure.

Figure 262 Menu 12. 1: Edit IP Static Route

```

Menu 12.1 - Edit IP Static Route

Route #: 3
Route Name= ?
Active= No
Destination IP Address= ?
IP Subnet Mask= ?
Gateway IP Address= ?
Metric= 2
Private= No

Press ENTER to CONFIRM or ESC to CANCEL:

```

The following table describes the IP Static Route Menu fields.

Table 184 Menu 12. 1: Edit IP Static Route

FIELD	DESCRIPTION
Route #	This is the index number of the static route that you chose in menu 12.
Route Name	Enter a descriptive name for this route. This is for identification purposes only.
Active	This field allows you to activate/deactivate this static route.
Destination IP Address	This parameter specifies the IP network address of the final destination. Routing is always based on network number. If you need to specify a route to a single host, use a subnet mask of 255.255.255.255 in the subnet mask field to force the network number to be identical to the host ID.
IP Subnet Mask	Enter the IP subnet mask for this destination.
Gateway IP Address	Enter the IP address of the gateway. The gateway is an immediate neighbor of your ZyWALL that will forward the packet to the destination. On the LAN, the gateway must be a router on the same segment as your ZyWALL; over the WAN, the gateway must be the IP address of one of the remote nodes.
Metric	Enter a number from 1 to 15 to set this route's priority among the ZyWALL's routes (see Section 7.5 on page 135). The smaller the number, the higher priority the route has.
Private	This parameter determines if the ZyWALL will include the route to this remote node in its RIP broadcasts. If set to Yes , this route is kept private and not included in RIP broadcast. If No , the route to this remote node will be propagated to other hosts through RIP broadcasts.
Once you have completed filling in this menu, press [ENTER] at the message "Press ENTER to Confirm..." to save your configuration, or press [ESC] to cancel.	

CHAPTER 35

Network Address Translation (NAT)

This chapter discusses how to configure NAT on the ZyWALL.

35.1 Using NAT

Note: You must create a firewall rule in addition to setting up SUA/NAT, to allow traffic from the WAN to be forwarded through the ZyWALL.

35.1.1 SUA (Single User Account) Versus NAT

SUA (Single User Account) is a ZyNOS implementation of a subset of NAT that supports two types of mapping, **Many-to-One** and **Server**. See [Section 35.2.1 on page 476](#) for a detailed description of the NAT set for SUA. The ZyWALL also supports **Full Feature** NAT to map multiple global IP addresses to multiple private LAN IP addresses of clients or servers using mapping types.

Note: Choose **SUA Only** if you have just one public WAN IP address for your ZyWALL.

Choose **Full Feature** if you have multiple public WAN IP addresses for your ZyWALL.

35.1.2 Applying NAT

You apply NAT via menus 4 or 11.1.2 as displayed next. The next figure shows you how to apply NAT for Internet access in menu 4. Enter 4 from the main menu to go to **Menu 4 - Internet Access Setup**.

Figure 263 Menu 4: Applying NAT for Internet Access

```
Menu 4 - Internet Access Setup

ISP's Name= ChangeMe
Encapsulation= Ethernet
  Service Type= Standard
My Login= N/A
My Password= N/A
Retype to Confirm= N/A
Login Server= N/A
Relogin Every (min)= N/A
IP Address Assignment= Dynamic
  IP Address= N/A
  IP Subnet Mask= N/A
  Gateway IP Address= N/A
Network Address Translation= SUA Only

Press ENTER to Confirm or ESC to Cancel:
```

The following figure shows how you apply NAT to the remote node in menu 11.1.

- 1 Enter 11 from the main menu.
- 2 Enter 1 to open **Menu 11.1 - Remote Node Profile**.
- 3 Move the cursor to the **Edit IP** field, press [SPACE BAR] to select **Yes** and then press [ENTER] to bring up **Menu 11.1.2 - Remote Node Network Layer Options**.

Figure 264 Menu 11.1.2: Applying NAT to the Remote Node

```
Menu 11.1.2 - Remote Node Network Layer Options

IP Address Assignment= Dynamic
IP Address= N/A
IP Subnet Mask= N/A
Gateway IP Addr= N/A

Network Address Translation= Full Feature
Metric= 1
Private= N/A
RIP Direction= None
  Version= N/A
Multicast= None

Enter here to CONFIRM or ESC to CANCEL:
```

The following table describes the fields in this menu.

Table 185 Applying NAT in Menus 4 & 11.1.2

FIELD	DESCRIPTION	OPTIONS
Network Address Translation	When you select this option the SMT will use Address Mapping Set 1 (menu 15.1 - see Section 35.2.1 on page 476 for further discussion). You can configure any of the mapping types described in Chapter 17 on page 297 . Choose Full Feature if you have multiple public WAN IP addresses for your ZyWALL. When you select Full Feature you must configure at least one address mapping set.	Full Feature
	NAT is disabled when you select this option.	None
	When you select this option the SMT will use Address Mapping Set 255 (menu 15.1 - see Section 35.2.1 on page 476). Choose SUA Only if you have just one public WAN IP address for your ZyWALL.	SUA Only

35.2 NAT Setup

Use the address mapping sets menus and submenus to create the mapping table used to assign global addresses to computers on the LAN and the DMZ. **Set 255** is used for SUA. When you select **Full Feature** in menu 4, menu 11.1.2 or menu 11.2.2, the SMT will use **Set 1** for the first WAN port and **Set 2** for the second WAN port. When you select **SUA Only**, the SMT will use the pre-configured **Set 255** (read only).

The server set is a list of LAN and DMZ servers mapped to external ports. To use this set, a server rule must be set up inside the NAT address mapping set. Please see the section on port forwarding in [Chapter 17 on page 297](#) for further information on these menus. To configure NAT, enter 15 from the main menu to bring up the following screen.

Figure 265 Menu 15: NAT Setup

```

Menu 15 - NAT Setup

    1. Address Mapping Sets
    2. Port Forwarding Setup
    3. Trigger Port Setup

Enter Menu Selection Number:

```

Note: Configure DMZ and LAN IP addresses in NAT menus 15.1 and 15.2. DMZ IP addresses must be on subnets separate from LAN IP addresses.

35.2.1 Address Mapping Sets

Enter 1 to bring up **Menu 15.1 - Address Mapping Sets**.

Figure 266 Menu 15.1: Address Mapping Sets

```

Menu 15.1 - Address Mapping Sets

    1. NAT_SET
    2. example
   255. SUA (read only)

Enter Menu Selection Number:

```

35.2.1.1 SUA Address Mapping Set

Enter 255 to display the next screen (see also [Section 35.1.1 on page 473](#)). The fields in this menu cannot be changed.

Figure 267 Menu 15.1.255: SUA Address Mapping Rules

```

Menu 15.1.1 - Address Mapping Rules

Set Name= SUA

Idx  Local Start IP   Local End IP   Global Start IP  Global End IP   Type
---  -
1.   0.0.0.0          255.255.255.255  0.0.0.0          M-1
2.                                     0.0.0.0          Server
3.
4.
5.
6.
7.
8.
9.
10.

Press ENTER to Confirm or ESC to Cancel:

```

The following table explains the fields in this menu.

Note: Menu 15.1.255 is read-only.

Table 186 SUA Address Mapping Rules

FIELD	DESCRIPTION
Set Name	This is the name of the set you selected in menu 15.1 or enter the name of a new set you want to create.
Idx	This is the index or rule number.
Local Start IP	Local Start IP is the starting local IP address (ILA).
Local End IP	Local End IP is the ending local IP address (ILA). If the rule is for all local IPs, then the start IP is 0.0.0.0 and the end IP is 255.255.255.255.
Global Start IP	This is the starting global IP address (IGA). If you have a dynamic IP, enter 0.0.0.0 as the Global Start IP .
Global End IP	This is the ending global IP address (IGA).
Type	These are the mapping types discussed above. Server allows us to specify multiple servers of different types behind NAT to this machine. See later for some examples.
Once you have finished configuring a rule in this menu, press [ENTER] at the message "Press ENTER to Confirm..." to save your configuration, or press [ESC] to cancel.	

35.2.1.2 User-Defined Address Mapping Sets

Now look at option 1 in menu 15.1. Enter 1 to bring up this menu. Look at the differences from the previous menu. Note the extra **Action** and **Select Rule** fields mean you can configure rules in this screen. Note also that the [?] in the **Set Name** field means that this is a required field and you must enter a name for the set.

Note: The entire set will be deleted if you leave the Set Name field blank and press [ENTER] at the bottom of the screen.

Figure 268 Menu 15.1.1: First Set

```

Menu 15.1.1.1 - Address Mapping Rules

Set Name= NAT_SET

Idx  Local Start IP  Local End IP  Global Start IP  Global End IP  Type
---  -
1.   0.0.0.0         255.255.255.255  0.0.0.0         M-1
2.                                     0.0.0.0         Server
3.
4.
5.
6.
7.
8.
9.
10.

Action= None          Select Rule= N/A

Press ENTER to Confirm or ESC to Cancel:
    
```

Note: The Type, Local and Global Start/End IPs are configured in menu 15.1.1.1 (described later) and the values are displayed here.

35.2.1.3 Ordering Your Rules

Ordering your rules is important because the ZyWALL applies the rules in the order that you specify. When a rule matches the current packet, the ZyWALL takes the corresponding action and the remaining rules are ignored. If there are any empty rules before your new configured rule, your configured rule will be pushed up by that number of empty rules. For example, if you have already configured rules 1 to 6 in your current set and now you configure rule number 9. In the set summary screen, the new rule will be rule 7, not 9.

Now if you delete rule 4, rules 5 to 7 will be pushed up by 1 rule, so as old rule 5 becomes rule 4, old rule 6 becomes rule 5 and old rule 7 becomes rule 6.

Table 187 Fields in Menu 15.1.1

FIELD	DESCRIPTION
Set Name	Enter a name for this set of rules. This is a required field. If this field is left blank, the entire set will be deleted.

Table 187 Fields in Menu 15.1.1 (continued)

FIELD	DESCRIPTION
Action	The default is Edit . Edit means you want to edit a selected rule (see following field). Insert Before means to insert a rule before the rule selected. The rules after the selected rule will then be moved down by one rule. Delete means to delete the selected rule and then all the rules after the selected one will be advanced one rule. None disables the Select Rule item.
Select Rule	When you choose Edit , Insert Before or Delete in the previous field the cursor jumps to this field to allow you to select the rule to apply the action in question.

Note: You must press [ENTER] at the bottom of the screen to save the whole set. You must do this again if you make any changes to the set – including deleting a rule. No changes to the set take place until this action is taken.

Selecting **Edit** in the **Action** field and then selecting a rule brings up the following menu, **Menu 15.1.1.1 - Address Mapping Rule** in which you can edit an individual rule and configure the **Type**, **Local** and **Global Start/End IPs**.

Note: An IP End address must be numerically greater than its corresponding IP Start address.

Figure 269 Menu 15.1.1.1: Editing/Configuring an Individual Rule in a Set

```

Menu 15.1.1.1 Address Mapping Rule

Type= One-to-One

Local IP:
  Start=
  End  = N/A

Global IP:
  Start=
  End  = N/A

Server Mapping Set= N/A

Press ENTER to Confirm or ESC to Cancel:

```

The following table describes the fields in this menu.

Table 188 Menu 15.1.1.1: Editing/Configuring an Individual Rule in a Set

FIELD	DESCRIPTION
Type	Press [SPACE BAR] and then [ENTER] to select from a total of five types. These are the mapping types discussed in Chapter 17 on page 297 . Server allows you to specify multiple servers of different types behind NAT to this computer. See Section 35.4.3 on page 485 for an example.
Local IP	Only local IP fields are N/A for server; Global IP fields MUST be set for Server .
Start	Enter the starting local IP address (ILA).
End	Enter the ending local IP address (ILA). If the rule is for all local IPs, then put the Start IP as 0.0.0.0 and the End IP as 255.255.255.255. This field is N/A for One-to-One and Server types.
Global IP	
Start	Enter the starting global IP address (IGA). If you have a dynamic IP, enter 0.0.0.0 as the Global IP Start . Note that Global IP Start can be set to 0.0.0.0 only if the types are Many-to-One or Server .
End	Enter the ending global IP address (IGA). This field is N/A for One-to-One , Many-to-One and Server types.
Server Mapping Set	This field is available only when you select Server in the Type field.
Once you have finished configuring a rule in this menu, press [ENTER] at the message "Press ENTER to Confirm..." to save your configuration, or press [ESC] to cancel.	

35.3 Configuring a Server behind NAT

Note: If you do not assign a **Default Server** IP address, the ZyWALL discards all packets received for ports that are not specified here or in the remote management setup.

Follow these steps to configure a server behind NAT:

- 1 Enter 15 in the main menu to go to **Menu 15 - NAT Setup**.
- 2 Enter 2 to open **Menu 15.2 - NAT Server Sets**.

Figure 270 Menu 15.2: NAT Server Sets

```

Menu 15.2 - NAT Server Sets

1. Server Set 1
2. Server Set 2

Enter Set Number to Edit:

```

- 3** Enter 1 to go to **Menu 15.2.1 - NAT Server Setup** and configure the address mapping rules for the WAN 1 port.

Figure 271 Menu 15.2.1: NAT Server Sets

```

Menu 15.2.1 - NAT Server Setup

Default Server: 0.0.0.0

```

Rule	Act.	Start Port	End Port	IP Address
001	No	0	0	0.0.0.0
002	No	0	0	0.0.0.0
003	No	0	0	0.0.0.0
004	No	0	0	0.0.0.0
005	No	0	0	0.0.0.0
006	No	0	0	0.0.0.0
007	No	0	0	0.0.0.0
008	No	0	0	0.0.0.0
009	No	0	0	0.0.0.0
010	No	0	0	0.0.0.0

```

Select Command= None          Select Rule= N/A
Press ENTER to Confirm or ESC to Cancel:

```

- 4** Select **Edit Rule** in the **Select Command** field; type the index number of the NAT server you want to configure in the **Select Rule** field and press [ENTER] to open **Menu 15.2.1.2 - NAT Server Configuration** (see the next figure).

Figure 272 15.2.1.2: NAT Server Configuration

```

15.2.1.2 - NAT Server Configuration

      Wan= 1                               Index= 2

-----

      Name= 1

      Active= Yes

      Start port= 21                       End port= 25

      IP Address= 192.168.1.33

      Press ENTER to Confirm or ESC to Cancel:

```

The following table describes the fields in this screen.

Table 189 15.2.1.2: NAT Server Configuration

FIELD	DESCRIPTION
WAN	The ZyWALL has two WAN ports. You can configure port forwarding and trigger port rules for the first WAN port and separate sets of rules for the second WAN port. This is the WAN port (server set) you select in menu 15.2.
Index	This is the index number of an individual port forwarding server entry.
Name	Enter a name to identify this port-forwarding rule.
Active	Press [SPACE BAR] and then [ENTER] to select Yes to enable the NAT server entry.
Start Port	Enter a port number in the Start Port field. To forward only one port, enter it again in the End Port field. To specify a range of ports, enter the last port to be forwarded in the End Port field.
End Port	
IP Address	Enter the inside IP address of the server.
When you have completed this menu, press [ENTER] at the prompt "Press ENTER to Confirm..." to save your configuration, or press [ESC] at any time to cancel.	

- 5** Enter a port number in the **Start Port** field. To forward only one port, enter it again in the **End Port** field. To specify a range of ports, enter the last port to be forwarded in the **End Port** field.
- 6** Enter the inside IP address of the server in the **IP Address** field. In the following figure, you have a computer acting as an FTP, Telnet and SMTP server (ports 21, 23 and 25) at 192.168.1.33.
- 7** Press [ENTER] at the "Press ENTER to confirm ..." prompt to save your configuration after you define all the servers or press [ESC] at any time to cancel.

Figure 273 Menu 15.2.1: NAT Server Setup

Menu 15.2.1 - NAT Server Setup				
Default Server: 0.0.0.0				
Rule	Act.	Start Port	End Port	IP Address
001	No	0	0	0.0.0.0
002	Yes	21	25	192.168.1.33
003	No	0	0	0.0.0.0
004	No	0	0	0.0.0.0
005	No	0	0	0.0.0.0
006	No	0	0	0.0.0.0
007	No	0	0	0.0.0.0
008	No	0	0	0.0.0.0
009	No	0	0	0.0.0.0
010	No	0	0	0.0.0.0

Select Command= None Select Rule= N/A
Press ENTER to Confirm or ESC to Cancel:

You assign the private network IP addresses. The NAT network appears as a single host on the Internet. A is the FTP/Telnet/SMTP server.

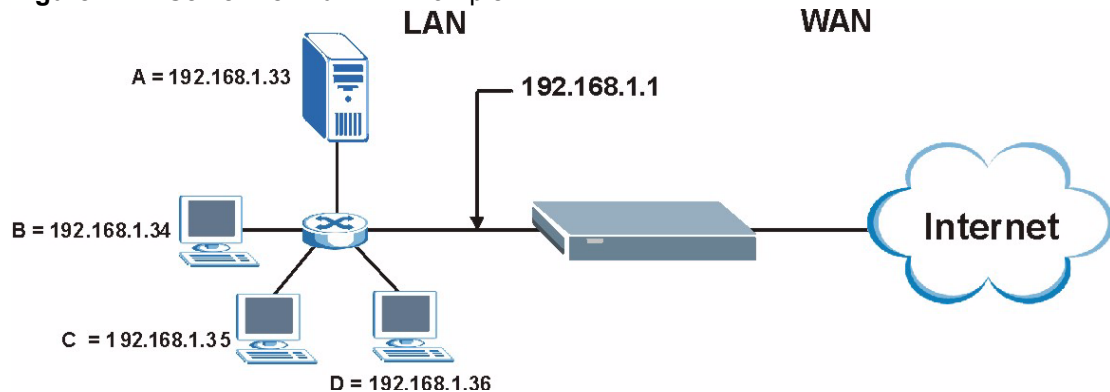
Figure 274 Server Behind NAT Example

35.4 General NAT Examples

The following are some examples of NAT configuration.

35.4.1 Internet Access Only

In the following Internet access example, you only need one rule where all your ILAs (Inside Local addresses) map to one dynamic IGA (Inside Global Address) assigned by your ISP.

Figure 275 NAT Example 1

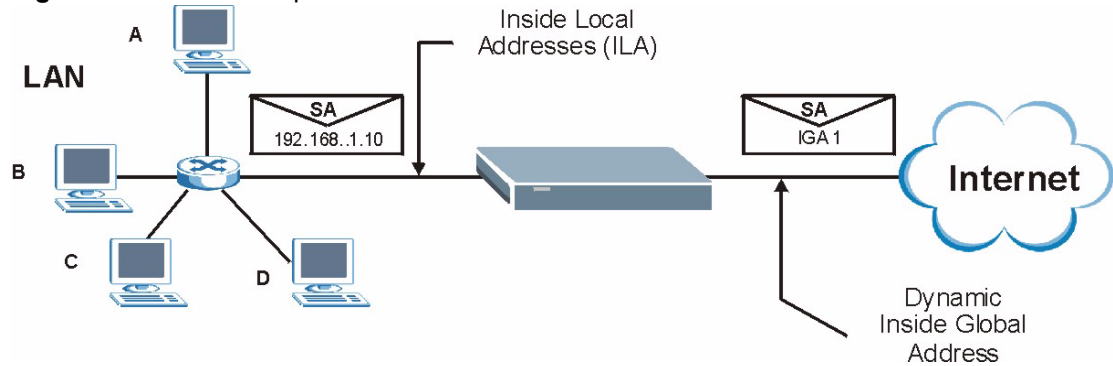

Figure 276 Menu 4: Internet Access & NAT Example

```

Menu 4 - Internet Access Setup

ISP's Name= ChangeMe
Encapsulation= Ethernet
Service Type= Standard
My Login= N/A
My Password= N/A
Retype to Confirm= N/A
Login Server= N/A
Relogin Every (min)= N/A
IP Address Assignment= Dynamic
IP Address= N/A
IP Subnet Mask= N/A
Gateway IP Address= N/A
Network Address Translation= SUA Only

Press ENTER to Confirm or ESC to Cancel:

```

From menu 4 shown above, simply choose the **SUA Only** option from the **Network Address Translation** field. This is the Many-to-One mapping discussed in [Section 35.4 on page 483](#). The **SUA Only** read-only option from the **Network Address Translation** field in menus 4 and 11.3 is specifically pre-configured to handle this case.

35.4.2 Example 2: Internet Access with an Default Server

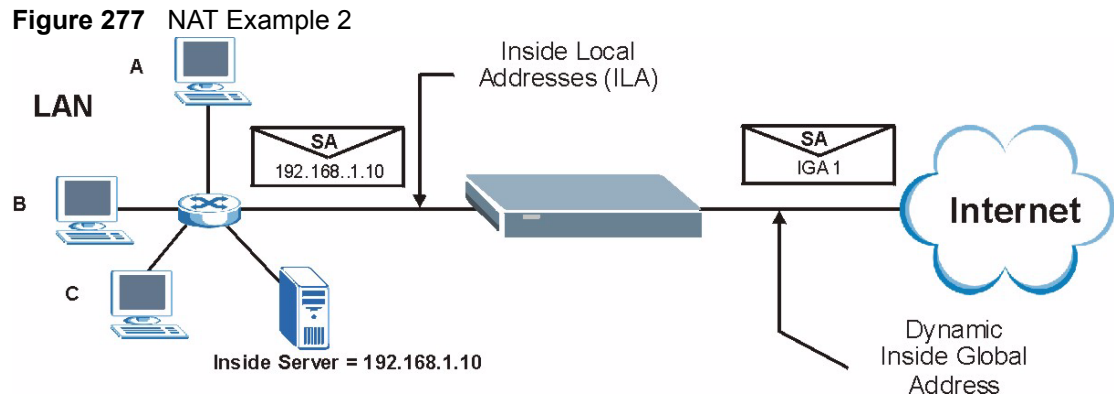

In this case, you do exactly as above (use the convenient pre-configured **SUA Only** set) and also go to menu 15.2.1 to specify the **Default Server** behind the NAT as shown in the next figure.

Figure 278 Menu 15.2.1: Specifying an Inside Server

Menu 15.2.1 - NAT Server Setup

Default Server: 192.168.1.10

Rule	Act.	Start Port	End Port	IP Address
001	No	0	0	0.0.0.0
002	Yes	21	25	192.168.1.33
003	No	0	0	0.0.0.0
004	No	0	0	0.0.0.0
005	No	0	0	0.0.0.0
006	No	0	0	0.0.0.0
007	No	0	0	0.0.0.0
008	No	0	0	0.0.0.0
009	No	0	0	0.0.0.0
010	No	0	0	0.0.0.0

Select Command= None Select Rule= N/A
Press ENTER to Confirm or ESC to Cancel:

35.4.3 Example 3: Multiple Public IP Addresses With Inside Servers

In this example, there are 3 IGAs from our ISP. There are many departments but two have their own FTP server. All departments share the same router. The example will reserve one IGA for each department with an FTP server and all departments use the other IGA. Map the FTP servers to the first two IGAs and the other LAN traffic to the remaining IGA. Map the third IGA to an inside web server and mail server. Four rules need to be configured, two bi-directional and two uni-directional as follows.

- 1 Map the first IGA to the first inside FTP server for FTP traffic in both directions (**1 : 1** mapping, giving both local and global IP addresses).
- 2 Map the second IGA to our second inside FTP server for FTP traffic in both directions (**1 : 1** mapping, giving both local and global IP addresses).
- 3 Map the other outgoing LAN traffic to IGA3 (**Many : 1** mapping).
- 4 You also map your third IGA to the web server and mail server on the LAN. Type **Server** allows you to specify multiple servers, of different types, to other computers behind NAT on the LAN.

The example situation looks somewhat like this:

Figure 279 NAT Example 3

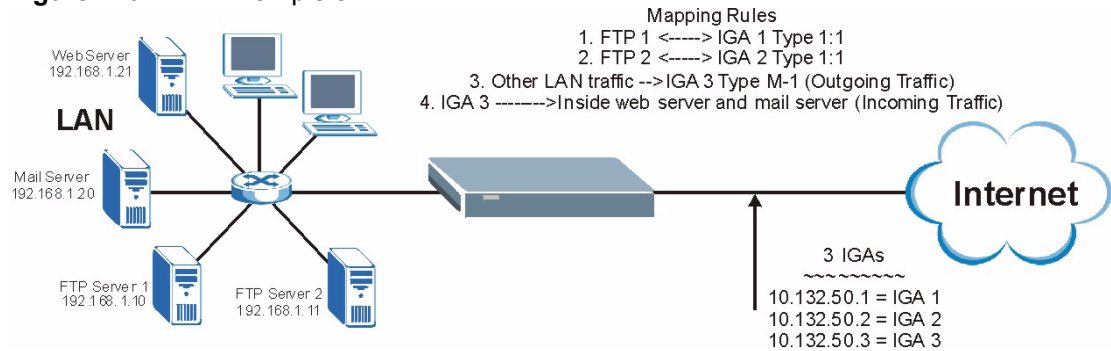

- 1 In this case you need to configure Address Mapping Set 1 from **Menu 15.1 - Address Mapping Sets**. Therefore you must choose the **Full Feature** option from the **Network Address Translation** field (in menu 4 or menu 11.3) in [Figure 280 on page 487](#).
- 2 Then enter 15 from the main menu.
- 3 Enter 1 to configure the Address Mapping Sets.
- 4 Enter 1 to begin configuring this new set. Enter a Set Name, choose the **Edit Action** and then enter 1 for the **Select Rule** field. Press [ENTER] to confirm.
- 5 Select **Type** as **One-to-One** (direct mapping for packets going both ways), and enter the local **Start IP** as 192.168.1.10 (the IP address of FTP Server 1), the global **Start IP** as 10.132.50.1 (our first IGA). (See [Figure 281 on page 487](#)).
- 6 Repeat the previous step for rules 2 to 4 as outlined above.
- 7 When finished, menu 15.1.1 should look like as shown in [Figure 282 on page 488](#).

Figure 280 Example 3: Menu 11.1.2

```
Menu 11.1.2 - Remote Node Network Layer Options

IP Address Assignment= Dynamic
IP Address= N/A
IP Subnet Mask= N/A
Gateway IP Addr= N/A

Network Address Translation= SUA Only
Metric= 2
Private=
RIP Direction= None
    Version= N/A
Multicast= None

Enter here to CONFIRM or ESC to CANCEL:
```

The following figure shows how to configure the first rule.

Figure 281 Example 3: Menu 15.1.1.1

```
Menu 15.1.1.1 Address Mapping Rule

Type= One-to-One

Local IP:
    Start= 192.168.1.10
    End = N/A

Global IP:
    Start= 10.132.50.1
    End = N/A

Server Mapping Set= N/A

Press ENTER to Confirm or ESC to Cancel:
```

Figure 282 Example 3: Final Menu 15.1.1

```
Menu 15.1.1 - Address Mapping Rules

Set Name= Example3

Idx  Local Start IP  Local End IP  Global Start IP  Global End IP  Type
---  -
1.  192.168.1.10      10.132.50.1   1-1
2.  192.168.1.11      10.132.50.2   1-1
3.  0.0.0.0           255.255.255.255  10.132.50.3   M-1
4.                                     10.132.50.3   Server
5.
6.
7.
8.
9.
10.

Action= Edit      Select Rule=

Press ENTER to Confirm or ESC to Cancel:
```

Now configure the IGA3 to map to our web server and mail server on the LAN.

- 1 Enter 15 from the main menu.
- 2 Enter 2 to go to **Menu 15.2 - NAT Server Sets**.
- 3 Now enter 1 from this menu and configure it as shown in [Figure 283 on page 489](#).

Figure 283 Example 3: Menu 15.2.1

Menu 15.2.1 - NAT Server Setup				
Default Server: 0.0.0.0				
Rule	Act.	Start Port	End Port	IP Address
001	Yes	80	80	192.168.1.21
002	Yes	25	25	192.168.1.20
003	No	0	0	0.0.0.0
004	No	0	0	0.0.0.0
005	No	0	0	0.0.0.0
006	No	0	0	0.0.0.0
007	No	0	0	0.0.0.0
008	No	0	0	0.0.0.0
009	No	0	0	0.0.0.0
010	No	0	0	0.0.0.0

Select Command= None Select Rule= N/A
Press ENTER to Confirm or ESC to Cancel:

35.4.4 Example 4: NAT Unfriendly Application Programs

Some applications do not support NAT Mapping using TCP or UDP port address translation. In this case it is better to use **Many-One-to-One** mapping as port numbers do *not* change for **Many-One-to-One** (and **One-to-One**) NAT mapping types. The following figure illustrates this.

Figure 284 NAT Example 4

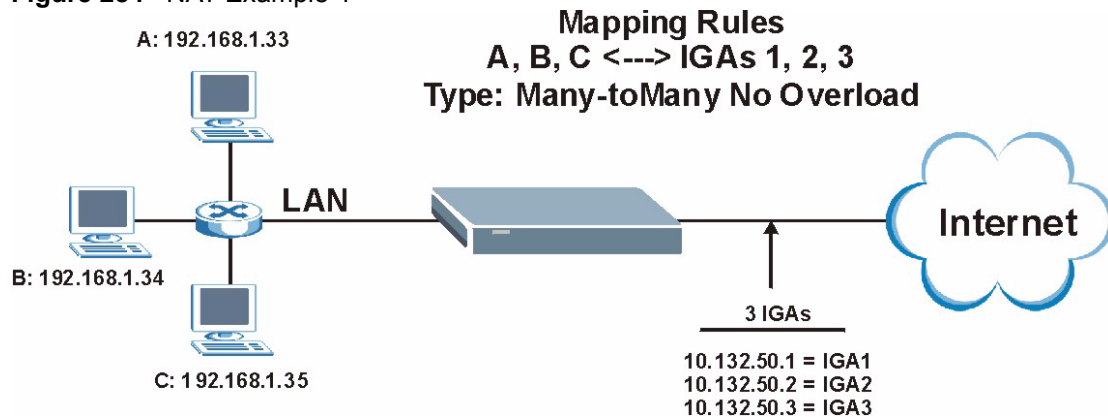

Note: Other applications such as some gaming programs are NAT unfriendly because they embed addressing information in the data stream. These applications won't work through NAT even when using **One-to-One** and **Many-One-to-One** mapping types.

Follow the steps outlined in example 3 above to configure these two menus as follows.

Figure 285 Example 4: Menu 15.1.1.1: Address Mapping Rule

```

Menu 15.1.1.1 Address Mapping Rule

Type= Many-One-to-One

Local IP:
  Start= 192.168.1.10
  End  = 192.168.1.12

Global IP:
  Start= 10.132.50.1
  End  = 10.132.50.3

Press ENTER to Confirm or ESC to Cancel:
    
```

After you've configured your rule, you should be able to check the settings in menu 15.1.1 as shown next.

Figure 286 Example 4: Menu 15.1.1: Address Mapping Rules

```

Menu 15.1.1 - Address Mapping Rules

Set Name= Example4

Idx  Local Start IP  Local End IP  Global Start IP  Global End IP  Type
---  -
1.   192.168.1.10    192.168.1.12  10.132.50.1     10.132.50.3   M-1-1
2.
3.
4.
5.
6.
7.
8.
9.
10.

Action= Edit          Select Rule=

Press ENTER to Confirm or ESC to Cancel:
    
```

35.5 Trigger Port Forwarding

Some services use a dedicated range of ports on the client side and a dedicated range of ports on the server side. With regular port forwarding you set a forwarding port in NAT to forward a service (coming in from the server on the WAN) to the IP address of a computer on the client side (LAN). The problem is that port forwarding only forwards a service to a single LAN IP address. In order to use the same service on a different LAN computer, you have to manually replace the LAN computer's IP address in the forwarding port with another LAN computer's IP address.

Trigger port forwarding solves this problem by allowing computers on the LAN to dynamically take turns using the service. The ZyWALL records the IP address of a LAN computer that sends traffic to the WAN to request a service with a specific port number and protocol (a "trigger" port). When the ZyWALL's WAN port receives a response with a specific port number and protocol ("incoming" port), the ZyWALL forwards the traffic to the LAN IP address of the computer that sent the request. After that computer's connection for that service closes, another computer on the LAN can use the service in the same manner. This way you do not need to configure a new IP address each time you want a different LAN computer to use the application.

35.5.1 Two Points To Remember About Trigger Ports

- 1 Trigger events only happen on data that is going coming from inside the ZyWALL and going to the outside.
- 2 If an application needs a continuous data stream, that port (range) will be tied up so that another computer on the LAN can't trigger it.

Note: Only one LAN computer can use a trigger port (range) at a time.

Enter 3 in menu 15 to display **Menu 15.3 - Trigger Ports**, and enter 1 or 2 to go to **Menu 15.3.x (where x is 1 or 2) - Trigger Port Setup** and configure trigger port rules for the first or second WAN port, shown next.

Figure 287 Menu 15.3.1: Trigger Port Setup

Menu 15.3.1 - Trigger Port Setup						
Rule	Name	Incoming		Trigger		
		Start Port	End Port	Start Port	End Port	
1.	Real Audio	6970	7170	7070	7070	
2.		0	0	0	0	
3.		0	0	0	0	
4.		0	0	0	0	
5.		0	0	0	0	
6.		0	0	0	0	
7.		0	0	0	0	
8.		0	0	0	0	
9.		0	0	0	0	
10.		0	0	0	0	
11.		0	0	0	0	
12.		0	0	0	0	

Press ENTER to Confirm or ESC to Cancel:

HTTP:80 FTP:21 Telnet:23 SMTP:25 POP3:110 PPTP:1723

The following table describes the fields in this menu.

Table 190 Menu 15.3: Trigger Port Setup

FIELD	DESCRIPTION
Rule	This is the rule index number.
Name	Enter a unique name for identification purposes. You may enter up to 15 characters in this field. All characters are permitted - including spaces.
Incoming	Incoming is a port (or a range of ports) that a server on the WAN uses when it sends out a particular service. The ZyWALL forwards the traffic with this port (or range of ports) to the client computer on the LAN that requested the service.
Start Port	Enter a port number or the starting port number in a range of port numbers.
End Port	Enter a port number or the ending port number in a range of port numbers.
Trigger	The trigger port is a port (or a range of ports) that causes (or triggers) the ZyWALL to record the IP address of the LAN computer that sent the traffic to a server on the WAN.
Start Port	Enter a port number or the starting port number in a range of port numbers.
End Port	Enter a port number or the ending port number in a range of port numbers.
Press [ENTER] at the message "Press ENTER to Confirm..." to save your configuration, or press [ESC] at any time to cancel.	

CHAPTER 36

Introducing the ZyWALL Firewall

This chapter shows you how to get started with the ZyWALL firewall.

36.1 Using ZyWALL SMT Menus

From the main menu enter 21 to go to **Menu 21 - Filter Set and Firewall Configuration** to display the screen shown next.

Figure 288 Menu 21: Filter and Firewall Setup

```
Menu 21 - Filter and Firewall Setup

      1. Filter Setup
      2. Firewall Setup

Enter Menu Selection Number:
```

36.1.1 Activating the Firewall

Enter option 2 in this menu to bring up the following screen. Press [SPACE BAR] and then [ENTER] to select **Yes** in the **Active** field to activate the firewall. The firewall must be active to protect against Denial of Service (DoS) attacks. Use the web configurator to configure firewall rules.

Figure 289 Menu 21.2: Firewall Setup

```
Menu 21.2 - Firewall Setup

The firewall protects against Denial of Service (DoS) attacks
when it is active.

Your network is vulnerable to attacks when the firewall is
turned off.

Refer to the User's Guide for details about the firewall
default policies.

You may define additional policy rules or modify existing ones
but please exercise extreme caution in doing so.

Active: Yes

You can use the Web Configurator to configure the firewall.

Press ENTER to Confirm or ESC to Cancel:
```

Note: Configure the firewall rules using the web configurator or CLI commands.

CHAPTER 37

Filter Configuration

This chapter shows you how to create and apply filters.

37.1 Introduction to Filters

Your ZyWALL uses filters to decide whether to allow passage of a data packet and/or to make a call. There are two types of filter applications: data filtering and call filtering. Filters are subdivided into device and protocol filters, which are discussed later.

Data filtering screens the data to determine if the packet should be allowed to pass. Data filters are divided into incoming and outgoing filters, depending on the direction of the packet relative to a port. Data filtering can be applied on either the WAN side or the LAN side. Call filtering is used to determine if a packet should be allowed to trigger a call. Remote node call filtering is only applicable when using PPPoE encapsulation. Outgoing packets must undergo data filtering before they encounter call filtering as shown in the following figure.

Figure 290 Outgoing Packet Filtering Process

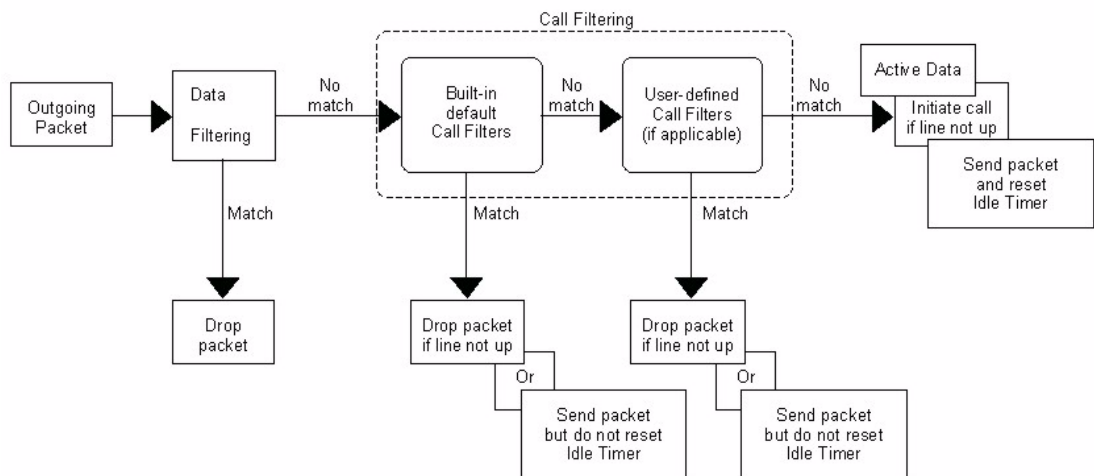

For incoming packets, your ZyWALL applies data filters only. Packets are processed depending upon whether a match is found. The following sections describe how to configure filter sets.

37.1.1 The Filter Structure of the ZyWALL

A filter set consists of one or more filter rules. Usually, you would group related rules, e.g., all the rules for NetBIOS, into a single set and give it a descriptive name. The ZyWALL allows you to configure up to twelve filter sets with six rules in each set, for a total of 72 filter rules in the system. You cannot mix device filter rules and protocol filter rules within the same set. You can apply up to four filter sets to a particular port to block multiple types of packets. With each filter set having up to six rules, you can have a maximum of 24 rules active for a single port.

Sets of factory default filter rules have been configured in menu 21 to prevent NetBIOS traffic from triggering calls and to prevent incoming telnet sessions. A summary of their filter rules is shown in the figures that follow.

The following figure illustrates the logic flow when executing a filter rule. See also [Figure 295 on page 502](#) for the logic flow when executing an IP filter.

Figure 291 Filter Rule Process

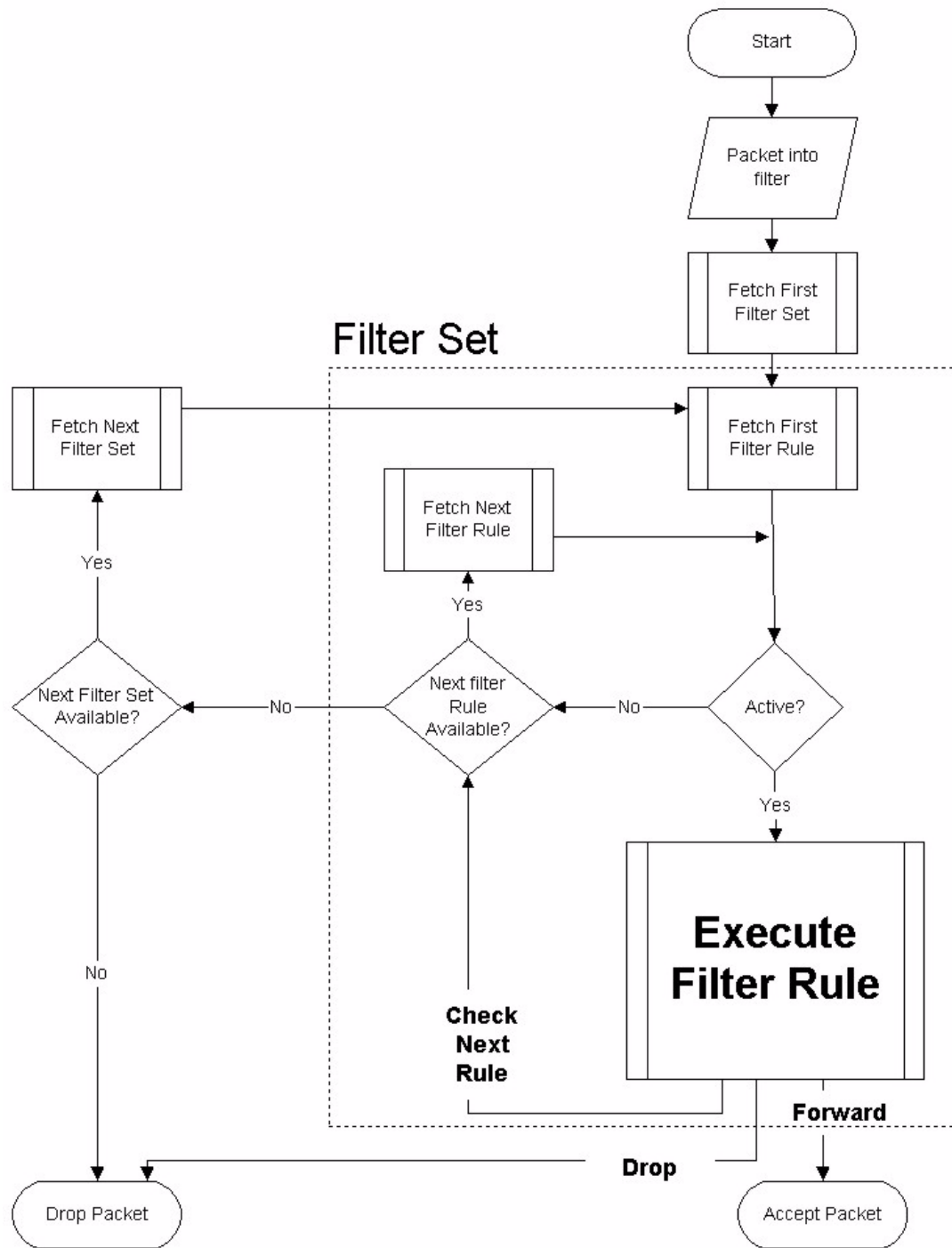

You can apply up to four filter sets to a particular port to block multiple types of packets. With each filter set having up to six rules, you can have a maximum of 24 rules active for a single port.

37.2 Configuring a Filter Set

The ZyWALL includes filtering for NetBIOS over TCP/IP packets by default. To configure another filter set, follow the procedure below.

- 1 Enter 21 in the main menu to open menu 21.

Figure 292 Menu 21: Filter and Firewall Setup

```

Menu 21 - Filter and Firewall Setup

      1. Filter Setup
      2. Firewall Setup

Enter Menu Selection Number:
    
```

- 2 Enter 1 to bring up the following menu.

Figure 293 Menu 21.1: Filter Set Configuration

```

Menu 21.1 - Filter Set Configuration

Filter Set #      Comments      Filter Set #      Comments
-----
1      _____      7      _____
2      _____      8      _____
3      _____      9      _____
4      _____     10     _____
5      _____     11     _____
6      _____     12     _____

Enter Filter Set Number to Configure= 0

Edit Comments= N/A

Press ENTER to Confirm or ESC to Cancel:
    
```

- 3 Select the filter set you wish to configure (1-12) and press [ENTER].
- 4 Enter a descriptive name or comment in the **Edit Comments** field and press [ENTER].
- 5 Press [ENTER] at the message [Press ENTER to confirm] to open **Menu 21.1.1 - Filter Rules Summary**.

This screen shows the summary of the existing rules in the filter set. The following tables contain a brief description of the abbreviations used in the previous menus.

Table 191 Abbreviations Used in the Filter Rules Summary Menu

FIELD	DESCRIPTION
A	Active: "Y" means the rule is active. "N" means the rule is inactive.
Type	The type of filter rule: "GEN" for Generic, "IP" for TCP/IP.
Filter Rules	These parameters are displayed here.
M	More. "Y" means there are more rules to check which form a rule chain with the present rule. An action cannot be taken until the rule chain is complete. "N" means there are no more rules to check. You can specify an action to be taken i.e., forward the packet, drop the packet or check the next rule. For the latter, the next rule is independent of the rule just checked.
m	Action Matched. "F" means to forward the packet immediately and skip checking the remaining rules. "D" means to drop the packet. "N" means to check the next rule.
n	Action Not Matched. "F" means to forward the packet immediately and skip checking the remaining rules. "D" means to drop the packet. "N" means to check the next rule.

The protocol dependent filter rules abbreviation are listed as follows:

Table 192 Rule Abbreviations Used

ABBREVIATION	DESCRIPTION
IP	Pr Protocol
	SA Source Address
	SP Source Port number
	DA Destination Address
	DP Destination Port number
GEN	Off Offset
	Len Length

Refer to the next section for information on configuring the filter rules.

37.2.1 Configuring a Filter Rule

To configure a filter rule, type its number in **Menu 21.1.1 - Filter Rules Summary** and press [ENTER] to open menu 21.1.1.1 for the rule.

To speed up filtering, all rules in a filter set must be of the same class, i.e., protocol filters or generic filters. The class of a filter set is determined by the first rule that you create. When applying the filter sets to a port, separate menu fields are provided for protocol and device filter sets. If you include a protocol filter set in a device filter field or vice versa, the ZyWALL will warn you and will not allow you to save.

37.2.2 Configuring a TCP/IP Filter Rule

This section shows you how to configure a TCP/IP filter rule. TCP/IP rules allow you to base the rule on the fields in the IP and the upper layer protocol, for example, UDP and TCP headers.

To configure TCP/IP rules, select **TCP/IP Filter Rule** from the **Filter Type** field and press [ENTER] to open **Menu 21.1.1.1 - TCP/IP Filter Rule**, as shown next.

Figure 294 Menu 21.1.1.1: TCP/IP Filter Rule

```

Menu 21.1.1.1 - TCP/IP Filter Rule

Filter #: 1,1
Filter Type= TCP/IP Filter Rule
Active= Yes
IP Protocol= 0      IP Source Route= No
Destination: IP Addr=
                IP Mask=
                Port #=
                Port # Comp= None
Source: IP Addr=
          IP Mask=
          Port #=
          Port # Comp= None
TCP Estab= N/A
More= No          Log= None
Action Matched= Check Next Rule
Action Not Matched= Check Next Rule

Press ENTER to Confirm or ESC to Cancel:
    
```

The following table describes how to configure your TCP/IP filter rule.

Table 193 Menu 21.1.1.1: TCP/IP Filter Rule

FIELD	DESCRIPTION
Active	Press [SPACE BAR] and then [ENTER] to select Yes to activate the filter rule or No to deactivate it.
IP Protocol	Protocol refers to the upper layer protocol, e.g., TCP is 6, UDP is 17 and ICMP is 1. Type a value between 0 and 255. A value of 0 matches ANY protocol.
IP Source Route	Press [SPACE BAR] and then [ENTER] to select Yes to apply the rule to packets with an IP source route option. Otherwise the packets must not have a source route option. The majority of IP packets do not have source route.

Table 193 Menu 21.1.1.1: TCP/IP Filter Rule

FIELD	DESCRIPTION
Destination	
IP Addr	Enter the destination IP Address of the packet you wish to filter. This field is ignored if it is 0.0.0.0.
IP Mask	Enter the IP mask to apply to the Destination: IP Addr .
Port #	Enter the destination port of the packets that you wish to filter. The range of this field is 0 to 65535. This field is ignored if it is 0.
Port # Comp	Press [SPACE BAR] and then [ENTER] to select the comparison to apply to the destination port in the packet against the value given in Destination: Port # . Options are None, Equal, Not Equal, Less and Greater .
Source	
IP Addr	Enter the source IP Address of the packet you wish to filter. This field is ignored if it is 0.0.0.0.
IP Mask	Enter the IP mask to apply to the Source: IP Addr .
Port #	Enter the source port of the packets that you wish to filter. The range of this field is 0 to 65535. This field is ignored if it is 0.
Port # Comp	Press [SPACE BAR] and then [ENTER] to select the comparison to apply to the source port in the packet against the value given in Source: Port # . Options are None, Equal, Not Equal, Less and Greater .
TCP Estab	This field is applicable only when the IP Protocol field is 6, TCP. Press [SPACE BAR] and then [ENTER] to select Yes , to have the rule match packets that want to establish a TCP connection (SYN=1 and ACK=0); if No , it is ignored.
More	Press [SPACE BAR] and then [ENTER] to select Yes or No . If Yes , a matching packet is passed to the next filter rule before an action is taken; if No , the packet is disposed of according to the action fields. If More is Yes , then Action Matched and Action Not Matched will be N/A .
Log	Press [SPACE BAR] and then [ENTER] to select a logging option from the following: None – No packets will be logged. Action Matched - Only packets that match the rule parameters will be logged. Action Not Matched - Only packets that do not match the rule parameters will be logged. Both – All packets will be logged.
Action Matched	Press [SPACE BAR] and then [ENTER] to select the action for a matching packet. Options are Check Next Rule, Forward and Drop .
Action Not Matched	Press [SPACE BAR] and then [ENTER] to select the action for a packet not matching the rule. Options are Check Next Rule, Forward and Drop .
When you have Menu 21.1.1.1 - TCP/IP Filter Rule configured, press [ENTER] at the message "Press ENTER to Confirm" to save your configuration, or press [ESC] to cancel. This data will now be displayed on Menu 21.1.1 - Filter Rules Summary .	

The following figure illustrates the logic flow of an IP filter.

Figure 295 Executing an IP Filter

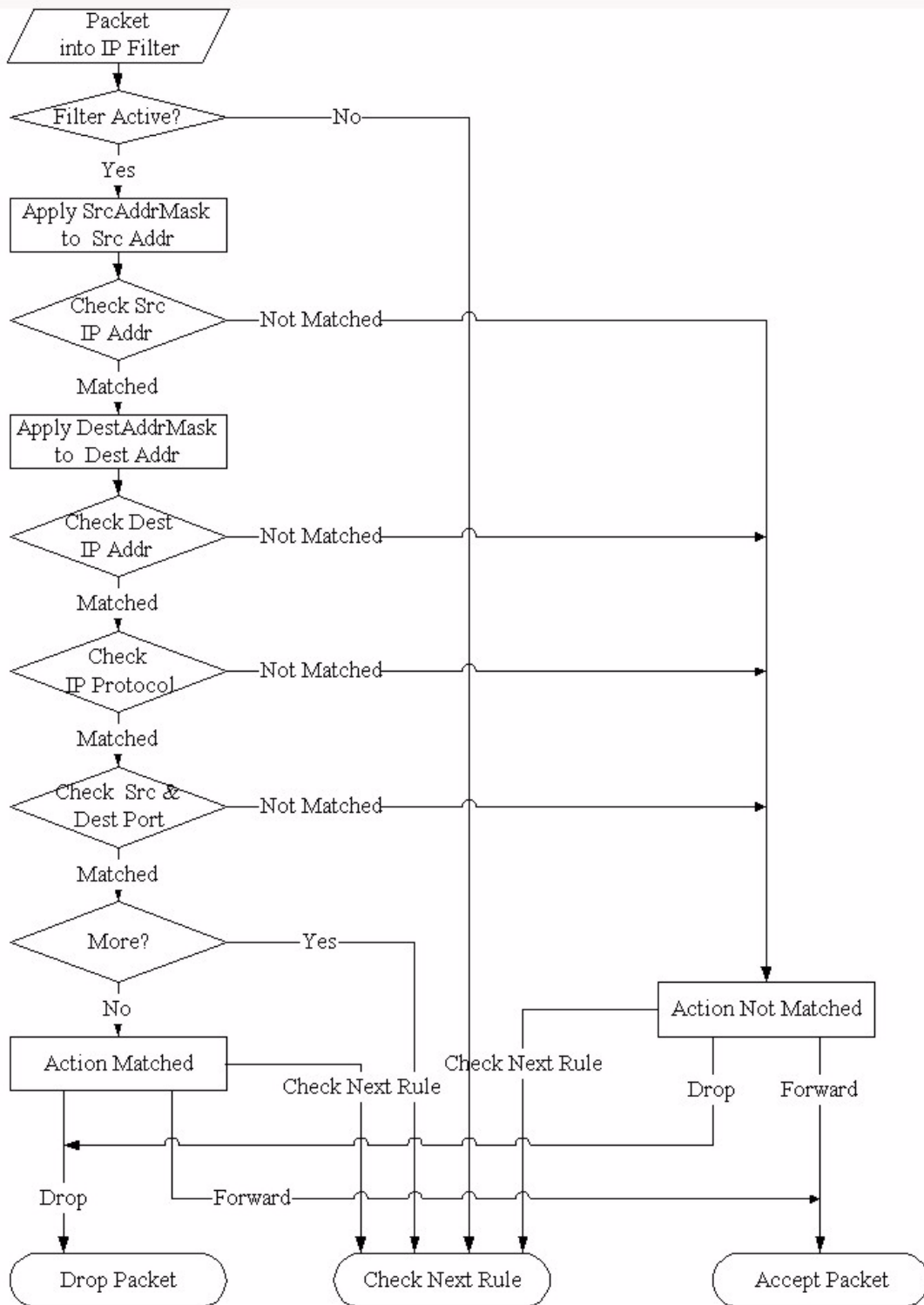

37.2.3 Configuring a Generic Filter Rule

This section shows you how to configure a generic filter rule. The purpose of generic rules is

to allow you to filter non-IP packets. For IP, it is generally easier to use the IP rules directly.

For generic rules, the ZyWALL treats a packet as a byte stream as opposed to an IP or IPX packet. You specify the portion of the packet to check with the **Offset** (from 0) and the **Length** fields, both in bytes. The ZyWALL applies the Mask (bit-wise ANDing) to the data portion before comparing the result against the Value to determine a match. The **Mask** and **Value** are specified in hexadecimal numbers. Note that it takes two hexadecimal digits to represent a byte, so if the length is 4, the value in either field will take 8 digits, for example, FFFFFFFF.

To configure a generic rule, select **Generic Filter Rule** in the **Filter Type** field in menu 21.1.1.1 and press [ENTER] to open Generic Filter Rule, as shown below.

Figure 296 Menu 21.1.1.1: Generic Filter Rule

```

Menu 21.1.1.1 - Generic Filter Rule

Filter #: 1,1
Filter Type= Generic Filter Rule
Active= No
Offset= 0
Length= 0
Mask= N/A
Value= N/A
More= No           Log= None
Action Matched= Check Next Rule
Action Not Matched= Check Next Rule

Press ENTER to Confirm or ESC to Cancel:

```

The following table describes the fields in the **Generic Filter Rule** menu.

Table 194 Generic Filter Rule Menu Fields

FIELD	DESCRIPTION
Filter #	This is the filter set, filter rule co-ordinates, i.e., 2,3 refers to the second filter set and the third rule of that set.
Filter Type	Use [SPACE BAR] and then [ENTER] to select a rule type. Parameters displayed below each type will be different. TCP/IP filter rules are used to filter IP packets while generic filter rules allow filtering of non-IP packets. Options are Generic Filter Rule and TCP/IP Filter Rule .
Active	Select Yes to turn on the filter rule or No to turn it off.
Offset	Enter the starting byte of the data portion in the packet that you wish to compare. The range for this field is from 0 to 255.
Length	Enter the byte count of the data portion in the packet that you wish to compare. The range for this field is 0 to 8.
Mask	Enter the mask (in Hexadecimal notation) to apply to the data portion before comparison.
Value	Enter the value (in Hexadecimal notation) to compare with the data portion.

Table 194 Generic Filter Rule Menu Fields

FIELD	DESCRIPTION
More	If Yes , a matching packet is passed to the next filter rule before an action is taken; else the packet is disposed of according to the action fields. If More is Yes , then Action Matched and Action Not Matched will be No .
Log	Select the logging option from the following: None - No packets will be logged. Action Matched - Only packets that match the rule parameters will be logged. Action Not Matched - Only packets that do not match the rule parameters will be logged. Both - All packets will be logged.
Action Matched	Select the action for a packet matching the rule. Options are Check Next Rule , Forward and Drop .
Action Not Matched	Select the action for a packet not matching the rule. Options are Check Next Rule , Forward and Drop .
Once you have completed filling in Menu 21.1.1.1 - Generic Filter Rule , press [ENTER] at the message "Press ENTER to Confirm" to save your configuration, or press [ESC] to cancel. This data will now be displayed on Menu 21.1.1 - Filter Rules Summary .	

37.3 Example Filter

Let's look at an example to block outside users from accessing the ZyWALL via telnet. Please see our included disk for more example filters.

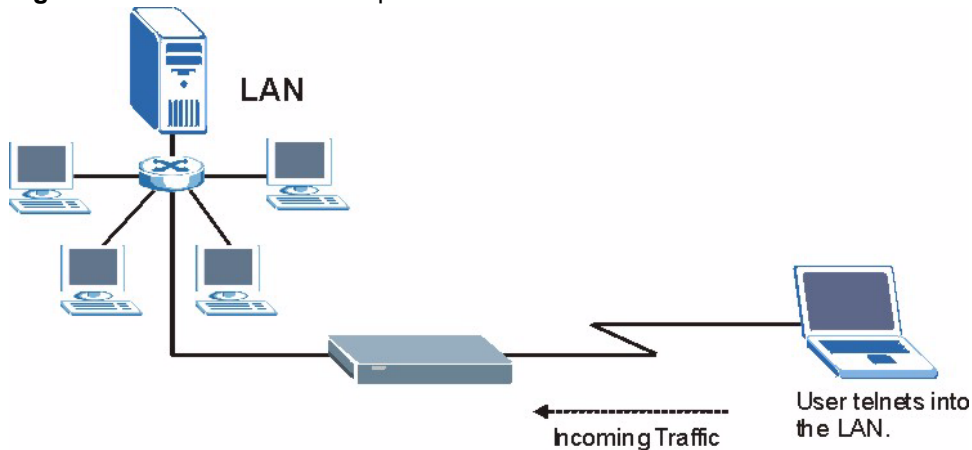
Figure 297 Telnet Filter Example

- 1 Enter 21 from the main menu to open **Menu 21 - Filter and Firewall Setup**.
- 2 Enter 1 to open Menu 21.1 - Filter Set Configuration.
- 3 Enter the index of the filter set you wish to configure (say 3) and press [ENTER].
- 4 Enter a descriptive name or comment in the **Edit Comments** field and press [ENTER].
- 5 Press [ENTER] at the message [Press ENTER to confirm] to open **Menu 21.1.3 - Filter Rules Summary**.
- 6 Enter 1 to configure the first filter rule (the only filter rule of this set). Make the entries in this menu as shown in the following figure.

Figure 298 Example Filter: Menu 21.1.3.1

```

Menu 21.1.3.1 - TCP/IP Filter Rule

Filter #: 3,1
Filter Type= TCP/IP Filter Rule
Active= Yes
IP Protocol= 6      IP Source Route= No
Destination: IP Addr= 0.0.0.0
              IP Mask= 0.0.0.0
              Port # = 23
              Port # Comp= Equal
Source: IP Addr= 0.0.0.0
        IP Mask= 0.0.0.0
        Port # = 0
        Port # Comp= None

TCP Estab= No
More= No          Log= None
Action Matched= Drop
Action Not Matched= Forward

Press ENTER to Confirm or ESC to Cancel:
Press Space Bar to Toggle.

```

The port number for the telnet service (TCP protocol) is **23**. See *RFC 1060* for port numbers of well-known services.

When you press [ENTER] to confirm, you will see the following screen. Note that there is only one filter rule in this set.

Figure 299 Example Filter Rules Summary: Menu 21.1.3

```

Menu 21.1.3 - Filter Rules Summary

# A Type          Filter Rules          M m n
- - - - -
1 Y IP   Pr=6, SA=0.0.0.0, DA=0.0.0.0, DP=23   N D F
2 N
3 N
4 N
5 N
6 N

Enter Filter Rule Number (1-6) to Configure: 1

```

This shows you that you have configured and activated (**A = Y**) a TCP/IP filter rule (**Type = IP, Pr = 6**) for destination telnet ports (**DP = 23**).

M = N means an action can be taken immediately. The action is to drop the packet (**m = D**) if the action is matched and to forward the packet immediately (**n = F**) if the action is not matched no matter whether there are more rules to be checked (there aren't in this example).

After you've created the filter set, you must apply it.

- 1 Enter 11 from the main menu to go to menu 11.
- 2 Enter 1 or 2 to open **Menu 11.x - Remote Node Profile**.
- 3 Go to the **Edit Filter Sets** field, press [SPACE BAR] to select **Yes** and press [ENTER].
- 4 This brings you to menu 11.1.4. Apply a filter set (our example filter set 3) as shown in [Figure 303 on page 508](#).
- 5 Press [ENTER] to confirm after you enter the set numbers and to leave menu 11.1.4.

37.4 Filter Types and NAT

There are two classes of filter rules, **Generic Filter** (Device) rules and protocol filter (**TCP/IP**) rules. Generic filter rules act on the raw data from/to LAN and WAN. Protocol filter rules act on the IP packets. Generic and TCP/IP filter rules are discussed in more detail in the next section. When NAT (Network Address Translation) is enabled, the inside IP address and port number are replaced on a connection-by-connection basis, which makes it impossible to know the exact address and port on the wire. Therefore, the ZyWALL applies the protocol filters to the "native" IP address and port number before NAT for outgoing packets and after NAT for incoming packets. On the other hand, the generic, or device filters are applied to the raw packets that appear on the wire. They are applied at the point when the ZyWALL is receiving and sending the packets; i.e. the interface. The interface can be an Ethernet port or any other hardware port. The following diagram illustrates this.

Figure 300 Protocol and Device Filter Sets

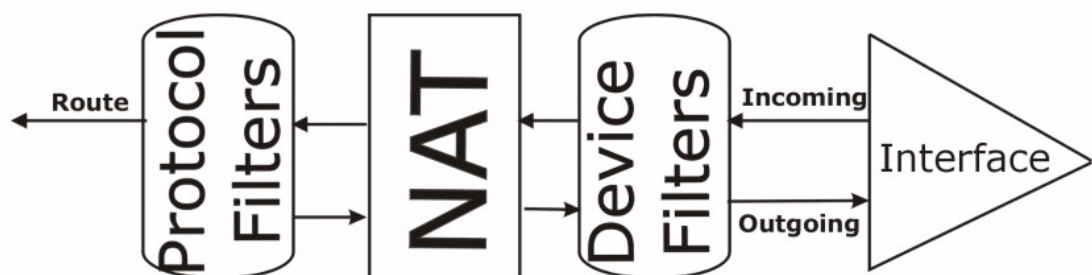

37.5 Firewall Versus Filters

Firewall configuration is discussed in [Chapter 10 on page 179](#). Further comparisons are also made between filtering, NAT and the firewall.

37.6 Applying a Filter

This section shows you where to apply the filter(s) after you design it (them). The ZyWALL already has filters to prevent NetBIOS traffic from triggering calls, and block incoming telnet, FTP and HTTP connections.

Note: If you do not activate the firewall, it is advisable to apply filters.

37.6.1 Applying LAN Filters

LAN traffic filter sets may be useful to block certain packets, reduce traffic and prevent security breaches. Go to menu 3.1 (shown next) and enter the number(s) of the filter set(s) that you want to apply as appropriate. You can choose up to four filter sets (from twelve) by entering their numbers separated by commas, e.g., 3, 4, 6, 11. Input filter sets filter incoming traffic to the ZyWALL and output filter sets filter outgoing traffic from the ZyWALL. For PPPoE or PPTP encapsulation, you have the additional option of specifying remote node call filter sets.

Figure 301 Filtering LAN Traffic

```
Menu 3.1 - LAN Port Filter Setup

Input Filter Sets:
  protocol filters=
  device filters=
Output Filter Sets:
  protocol filters=
  device filters=

Press ENTER to Confirm or ESC to Cancel:
```

37.6.2 Applying DMZ Filters

DMZ traffic filter sets may be useful to block certain packets, reduce traffic and prevent security breaches. Go to menu 5.1 (shown next) and enter the number(s) of the filter set(s) that you want to apply as appropriate. You can choose up to four filter sets (from twelve) by entering their numbers separated by commas, e.g., 3, 4, 6, 11. Input filter sets filter incoming traffic to the ZyWALL and output filter sets filter outgoing traffic from the ZyWALL. The ZyWALL already has filters to prevent NetBIOS traffic from triggering calls, and block incoming telnet, FTP and HTTP connections.

Figure 302 Filtering DMZ Traffic

```
Menu 5.1 - DMZ Port Filter Setup

Input Filter Sets:
  protocol filters=
  device filters=
Output Filter Sets:
  protocol filters=
  device filters=

Press ENTER to Confirm or ESC to Cancel:
```

37.6.3 Applying Remote Node Filters

Go to menu 11.1.4 (shown below – note that call filter sets are only present for PPPoE encapsulation) and enter the number(s) of the filter set(s) as appropriate. You can cascade up to four filter sets by entering their numbers separated by commas. The ZyWALL already has filters to prevent NetBIOS traffic from triggering calls, and block incoming telnet, FTP and HTTP connections.

Figure 303 Filtering Remote Node Traffic

```
Menu 11.1.4 - Remote Node Filter Setup

Input Filter Sets:
  protocol filters=
  device filters=
Output Filter Sets:
  protocol filters=
  device filters=

Press ENTER to Confirm or ESC to Cancel:
```

CHAPTER 38

SNMP Configuration

This chapter explains SNMP configuration menu 22.

38.1 SNMP Configuration

To configure SNMP, enter 22 from the main menu to display **Menu 22 - SNMP Configuration** as shown next. The “community” for **Get**, **Set** and **Trap** fields is SNMP terminology for password.

Figure 304 Menu 22: SNMP Configuration

```

Menu 22 - SNMP Configuration

SNMP:
  Get Community= public
  Set Community= public
  Trusted Host= 0.0.0.0
  Trap:
    Community= public
    Destination= 0.0.0.0

Press ENTER to Confirm or ESC to Cancel:

```

The following table describes the SNMP configuration parameters.

Table 195 SNMP Configuration Menu Fields

FIELD	DESCRIPTION
Get Community	Type the Get community, which is the password for the incoming Get- and GetNext requests from the management station.
Set Community	Type the Set community, which is the password for incoming Set requests from the management station.
Trusted Host	If you enter a trusted host, your ZyWALL will only respond to SNMP messages from this address. A blank (default) field means your ZyWALL will respond to all SNMP messages it receives, regardless of source.
Trap	
Community	Type the Trap community, which is the password sent with each trap to the SNMP manager.

Table 195 SNMP Configuration Menu Fields (continued)

FIELD	DESCRIPTION
Destination	Type the IP address of the station to send your SNMP traps to.
When you have completed this menu, press [ENTER] at the prompt "Press [ENTER] to confirm or [ESC] to cancel" to save your configuration or press [ESC] to cancel and go back to the previous screen.	

38.2 SNMP Traps

The ZyWALL will send traps to the SNMP manager when any one of the following events occurs:

Table 196 SNMP Traps

TRAP #	TRAP NAME	DESCRIPTION
0	coldStart (defined in <i>RFC-1215</i>)	A trap is sent after booting (power on).
1	warmStart (defined in <i>RFC-1215</i>)	A trap is sent after booting (software reboot).
4	authenticationFailure (defined in <i>RFC-1215</i>)	A trap is sent to the manager when receiving any SNMP get or set requirements with the wrong community (password).
6	whyReboot (defined in ZYXEL-MIB)	A trap is sent with the reason of restart before rebooting when the system is going to restart (warm start).
6a	For intentional reboot:	A trap is sent with the message "System reboot by user!" if reboot is done intentionally, (for example, download new files, CLI command "sys reboot", etc.).
6b	For fatal error:	A trap is sent with the message of the fatal code if the system reboots because of fatal errors.

CHAPTER 39

System Information & Diagnosis

This chapter covers SMT menus 24.1 to 24.4.

39.1 Introduction to System Status

This chapter covers the diagnostic tools that help you to maintain your ZyWALL. These tools include updates on system status, port status and log and trace capabilities.

Select menu 24 in the main menu to open **Menu 24 - System Maintenance**, as shown below.

Figure 305 Menu 24: System Maintenance

```
Menu 24 - System Maintenance

1. System Status
2. System Information and Console Port Speed
3. Log and Trace
4. Diagnostic
5. Backup Configuration
6. Restore Configuration
7. Upload Firmware
8. Command Interpreter Mode
9. Call Control
10. Time and Date Setting
11. Remote Management Setup

Enter Menu Selection Number:
```

39.2 System Status

The first selection, System Status, gives you information on the version of your system firmware and the status and statistics of the ports, as shown in the next figure. System Status is a tool that can be used to monitor your ZyWALL. Specifically, it gives you information on your system firmware version, number of packets sent and number of packets received.

To get to the System Status:

- 1 Enter number 24 to go to Menu 24 - System Maintenance.
- 2 In this menu, enter 1 to open System Maintenance - Status.

3 There are three commands in **Menu 24.1 - System Maintenance - Status**. Entering 1 drops the WAN connection, 9 resets the counters and [ESC] takes you back to the previous screen.

Figure 306 Menu 24.1: System Maintenance: Status

```

Menu 24.1 - System Maintenance - Status                                08:17:55
                                                                    Mon. Mar. 07, 2005

Port  Status      TxPkts    RxPkts    Cols    Tx B/s    Rx B/s    Up Time
WAN1  100M/Full    9439     332111    0        0         1062     2:35:42
WAN2  Down         0         0         0         0         0        0:00:00
LAN   100M/Full    7802     11353     0        354        192     2:35:42
WLAN  Down         0         0         0         0         0        0:00:00
DMZ   100M/Full    0         0         0         0         0        2:35:42

Port  Ethernet Address      IP Address      IP Mask      DHCP
WAN1  00:A0:C5:01:23:46     172.22.1.162   255.255.0.0  Client
WAN2  00:A0:C5:01:23:48     0.0.0.0        0.0.0.0      Client
LAN   00:A0:C5:01:23:45     192.168.1.1    255.255.255.0 Server
WLAN  00:00:00:00:00:00
DMZ   00:A0:C5:01:23:47     0.0.0.0        0.0.0.0      None

System up Time:      2:35:47

Press Command:

COMMANDS: 1, 2-Drop WAN1,2 9-Reset Counters  ESC-Exit
    
```

The following table describes the fields present in **Menu 24.1 - System Maintenance - Status**. These fields are READ-ONLY and meant for diagnostic purposes. The upper right corner of the screen shows the time and date according to the format you set in menu 24.10.

Table 197 System Maintenance: Status Menu Fields

FIELD	DESCRIPTION
Port	This field identifies a port (WAN1, WAN2, LAN, WLAN or DMZ) on the ZyWALL.
Status	This field shows the port speed and duplex setting if you're using Ethernet Encapsulation and Down (line is down), Idle (line (ppp) idle), Dial (starting to trigger a call) or Drop (dropping a call) if you're using PPPoE Encapsulation .
TxPkts	This is the number of transmitted packets on this port.
RxPkts	This is the number of received packets on this port.
Cols	This is the number of collisions on this port.
Tx B/s	This field shows the transmission speed in Bytes per second on this port.
Rx B/s	This field shows the reception speed in Bytes per second on this port.
Up Time	This is the total amount of time the line has been up.
Ethernet Address	This is the Ethernet address of the port listed on the left.
IP Address	This is the IP address of the port listed on the left.

Table 197 System Maintenance: Status Menu Fields (continued)

FIELD	DESCRIPTION
IP Mask	This is the IP mask of the port listed on the left.
DHCP	This is the DHCP setting of the port listed on the left.
System up Time	This is the total time the ZyWALL has been on.
You may enter 1 to drop the WAN connection, 9 to reset the counters or [ESC] to return to menu 24.	

39.3 System Information and Console Port Speed

This section describes your system and allows you to choose different console port speeds. To get to the System Information and Console Port Speed:

- 1 Enter 24 to go to **Menu 24 - System Maintenance**.
- 2 Enter 2 to open **Menu 24.2 - System Information and Console Port Speed**.
- 3 From this menu you have two choices as shown in the next figure:

Figure 307 Menu 24.2: System Information and Console Port Speed

Menu 24.2 - System Information and Console Port Speed
1. System Information 2. Console Port Speed
Please enter selection:

39.3.1 System Information

System Information gives you information about your system as shown below. More specifically, it gives you information on your routing protocol, Ethernet address, IP address, etc.

Figure 308 Menu 24.2.1: System Maintenance: Information

```

Menu 24.2.1 - System Maintenance - Information

Name:
Routing: IP
ZyNOS F/W Version: V3.64(WM.0) | 03/04/2005
Country Code: 255

LAN
Ethernet Address: 00:A0:C5:01:23:45
IP Address: 192.168.1.1
IP Mask: 255.255.255.0
DHCP: Server

Press ESC or RETURN to Exit:

```

The following table describes the fields in this screen.

Table 198 Fields in System Maintenance: Information

FIELD	DESCRIPTION
Name	This is the ZyWALL's system name + domain name assigned in menu 1. For example, System Name= xxx; Domain Name= baboo.mickey.com Name= xxx.baboo.mickey.com
Routing	Refers to the routing protocol used.
ZyNOS F/W Version	Refers to the version of ZyXEL's Network Operating System software.
Country Code	Refers to the country code of the firmware.
LAN	
Ethernet Address	Refers to the Ethernet MAC (Media Access Control) address of your ZyWALL.
IP Address	This is the IP address of the ZyWALL in dotted decimal notation.
IP Mask	This shows the IP mask of the ZyWALL.
DHCP	This field shows the DHCP setting of the ZyWALL.
When finished viewing, press [ESC] or [ENTER] to exit.	

39.3.2 Console Port Speed

You can change the speed of the console port through **Menu 24.2.2 – Console Port Speed**. Your ZyWALL supports 9600 (default), 19200, 38400, 57600, and 115200 bps for the console port. Press [SPACE BAR] and then [ENTER] to select the desired speed in menu 24.2.2, as shown next.

Figure 309 Menu 24.2.2: System Maintenance: Change Console Port Speed

```
Menu 24.2.2 - System Maintenance - Change Console Port Speed

      Console Port Speed: 9600

      Press ENTER to Confirm or ESC to Cancel:Press
      Space Bar to Toggle.
```

39.4 Log and Trace

There are two logging facilities in the ZyWALL. The first is the error logs and trace records that are stored locally. The second is the UNIX syslog facility for message logging.

39.4.1 Viewing Error Log

The first place you should look for clues when something goes wrong is the error/trace log. Follow the procedure below to view the local error/trace log:

- 1 Select option 24 from the main menu to open **Menu 24 - System Maintenance**.
- 2 From menu 24, select option 3 to open **Menu 24.3 - System Maintenance - Log and Trace**.
- 3 Select the first option from **Menu 24.3 - System Maintenance - Log and Trace** to display the error log in the system.

After the ZyWALL finishes displaying, you will have the option to clear the error log.

Figure 310 Menu 24.3: System Maintenance: Log and Trace

```
Menu 24.3 - System Maintenance - Log and Trace

1. View Error Log
2. UNIX Syslog

4. Call-Triggering Packet

      Please enter selection
```

Examples of typical error and information messages are presented in the following figure.

Figure 311 Examples of Error and Information Messages

```

52 Thu Jul 1 05:54:53 2004 PP05 ERROR Wireless LAN init fail,
code=15
53 Thu Jul 1 05:54:53 2004 PINI INFO Channel 0 ok
54 Thu Jul 1 05:54:56 2004 PP05 -WARN SNMP TRAP 3: interface
3: link up
55 Thu Jul 1 05:54:56 2004 PP0d INFO LAN promiscuous mode
<0>
57 Thu Jul 1 05:54:56 2004 PP0d INFO LAN promiscuous mode
<1>
58 Thu Jul 1 05:54:56 2004 PINI INFO Last errorlog repeat 1
Times
59 Thu Jul 1 05:54:56 2004 PINI INFO main: init completed
60 Thu Jul 1 05:55:26 2004 PSSV -WARN SNMP TRAP 0: cold start
61 Thu Jul 1 05:56:56 2004 PINI INFO SMT Session Begin
62 Thu Jul 1 07:50:58 2004 PINI INFO SMT Session End
63 Thu Jul 1 07:53:28 2004 PINI INFO SMT Session Begin
Clear Error Log (y/n):
    
```

39.4.2 Syslog Logging

The ZyWALL uses the syslog facility to log the CDR (Call Detail Record) and system messages to a syslog server. Syslog and accounting can be configured in **Menu 24.3.2 - System Maintenance - Syslog Logging**, as shown next.

Figure 312 Menu 24.3.2: System Maintenance: Syslog Logging

```

Menu 24.3.2 - System Maintenance - Syslog Logging

Syslog:
Active= No
Syslog Server IP Address= 0.0.0.0
Log Facility= Local 1

Press ENTER to Confirm or ESC to Cancel:
    
```

You need to configure the syslog parameters described in the following table to activate syslog then choose what you want to log.

Table 199 System Maintenance Menu Syslog Parameters

FIELD	DESCRIPTION
Syslog:	
Active	Press [SPACE BAR] and then [ENTER] to turn syslog on or off.
Syslog Server IP Address	Enter the server name or IP address of the syslog server that will log the selected categories of logs.

Table 199 System Maintenance Menu Syslog Parameters (continued)

FIELD	DESCRIPTION
Log Facility	Press [SPACE BAR] and then [ENTER] to select a location. The log facility allows you to log the messages to different files in the syslog server. Refer to the documentation of your syslog program for more details.
When finished configuring this screen, press [ENTER] to confirm or [ESC] to cancel.	

Your ZyWALL sends five types of syslog messages. Some examples (not all ZyWALL specific) of these syslog messages with their message formats are shown next:

1 CDR

CDR Message Format
<pre>SdcmdSyslogSend(SYSLOG_CDR, SYSLOG_INFO, String); String = board xx line xx channel xx, call xx, str board = the hardware board ID line = the WAN ID in a board Channel = channel ID within the WAN call = the call reference number which starts from 1 and increments by 1 for each new call str = C01 Outgoing Call dev xx ch xx (dev:device No. ch:channel No.) L02 Tunnel Connected(L2TP) C02 OutCall Connected xxxx (means connected speed) xxxxx (means Remote Call Number) L02 Call Terminated C02 Call Terminated Jul 19 11:19:27 192.168.102.2 ZyXEL: board 0 line 0 channel 0, call 1, C01 Outgoing Call dev=2 ch=0 40002 Jul 19 11:19:32 192.168.102.2 ZyXEL: board 0 line 0 channel 0, call 1, C02 OutCall Connected 64000 40002 Jul 19 11:20:06 192.168.102.2 ZyXEL: board 0 line 0 channel 0, call 1, C02 Call Terminated</pre>

2 Packet triggered

Packet triggered Message Format
<pre>SdcmdSyslogSend(SYSLOG_PKTTRI, SYSLOG_NOTICE, String); String = Packet trigger: Protocol=xx Data=xxxxxxxxxxxx...x Protocol: (1:IP 2:IPX 3:IPXHC 4:BPDU 5:ATALK 6:IPNG) Data: We will send forty-eight Hex characters to the server Jul 19 11:28:39 192.168.102.2 ZyXEL: Packet Trigger: Protocol=1, Data=4500003c100100001f010004c0a86614ca849a7b08004a5c020001006162636465666768696a 6b6c6d6e6f7071727374 Jul 19 11:28:56 192.168.102.2 ZyXEL: Packet Trigger: Protocol=1, Data=4500002c1b0140001f06b50ec0a86614ca849a7b0427001700195b3e0000000600220008cd4 0000020405b4 Jul 19 11:29:06 192.168.102.2 ZyXEL: Packet Trigger: Protocol=1, Data=45000028240140001f06ac12c0a86614ca849a7b0427001700195b451d143013500400007760 0000</pre>

3 Filter log

```

Filter log Message Format

SdcmdSyslogSend(SYSLOG_FILLOG, SYSLOG_NOTICE, String );
String = IP[Src=xx.xx.xx.xx Dst=xx.xx.xx.xx prot spo=xxxx dpo=xxxx] S04>R01mD
IP[...] is the packet header and S04>R01mD means filter set 4 (S) and rule 1 (R),
match (m) drop (D).
    Src: Source Address
    Dst: Destination Address
    prot: Protocol ("TCP","UDP","ICMP")
spo: Source port
dpo: Destination port
Mar 03 10:39:43 202.132.155.97 ZyXEL:
GEN[fffffffffnordff0080] }S05>R01mF
Mar 03 10:41:29 202.132.155.97 ZyXEL:
GEN[00a0c5f502fnord010080] }S05>R01mF
Mar 03 10:41:34 202.132.155.97 ZyXEL:
IP[Src=192.168.2.33 Dst=202.132.155.93 ICMP]}S04>R01mF
Mar 03 11:59:20 202.132.155.97 ZyXEL:
GEN[00a0c5f502fnord010080] }S05>R01mF
Mar 03 12:00:52 202.132.155.97 ZyXEL:
GEN[fffffffffnordff0080] }S05>R01mF
Mar 03 12:00:57 202.132.155.97 ZyXEL:
GEN[00a0c5f502010080] }S05>R01mF
Mar 03 12:01:06 202.132.155.97 ZyXEL:
IP[Src=192.168.2.33 Dst=202.132.155.93 TCP spo=01170 dpo=00021]}S04>R01mF
    
```

4 PPP log

```

PPP Log Message Format

SdcmdSyslogSend( SYSLOG_PPPLLOG, SYSLOG_NOTICE, String );
String = ppp:Proto Starting / ppp:Proto Opening / ppp:Proto Closing / ppp:Proto
Shutdown
Proto = LCP / ATCP / BACP / BCP / CBCP / CCP / CHAP/ PAP / IPCP /
IPXCP
Jul 19 11:42:44 192.168.102.2 ZyXEL: ppp:LCP Closing
Jul 19 11:42:49 192.168.102.2 ZyXEL: ppp:IPCP Closing
Jul 19 11:42:54 192.168.102.2 ZyXEL: ppp:CCP Closing
    
```

5 Firewall log

```

Firewall Log Message Format

SdcmdSyslogSend(SYSLOG_FIREWALL, SYSLOG_NOTICE, buf);
buf = IP[Src=xx.xx.xx.xx : spo=xxxx Dst=xx.xx.xx.xx : dpo=xxxx | prot | rule |
action]
Src: Source Address
spo: Source port (empty means no source port information)
Dst: Destination Address
dpo: Destination port (empty means no destination port information)
prot: Protocol ("TCP","UDP","ICMP", "IGMP", "GRE", "ESP")
rule: <a,b> where a means "set" number; b means "rule" number.
Action: nothing(N) block (B) forward (F)
08-01-200011:48:41Local1.Notice192.168.10.10RAS: FW 172.21.1.80 :137 -
>172.21.1.80 :137 |UDP|default permit:<2,0>|B
08-01-200011:48:41Local1.Notice192.168.10.10RAS: FW 192.168.77.88 :520 -
>192.168.77.88 :520 |UDP|default permit:<2,0>|B
08-01-200011:48:39Local1.Notice192.168.10.10RAS: FW 172.21.1.50 ->172.21.1.50
|IGMP<2>|default permit:<2,0>|B
08-01-200011:48:39Local1.Notice192.168.10.10RAS: FW 172.21.1.25 ->172.21.1.25
|IGMP<2>|default permit:<2,0>|B
    
```

39.4.3 Call-Triggering Packet

Call-Triggering Packet displays information about the packet that triggered a dial-out call in an easy readable format. Equivalent information is available in menu 24.1 in hex format. An example is shown next.

Figure 313 Call-Triggering Packet Example

```

IP Frame: ENET0-RECV Size: 44/ 44   Time: 17:02:44.262
Frame Type:

  IP Header:
    IP Version           = 4
    Header Length        = 20
    Type of Service      = 0x00 (0)
    Total Length         = 0x002C (44)
    Identification      = 0x0002 (2)
    Flags                = 0x00
    Fragment Offset      = 0x00
    Time to Live         = 0xFE (254)
    Protocol             = 0x06 (TCP)
    Header Checksum      = 0xFB20 (64288)
    Source IP            = 0xC0A80101 (192.168.1.1)
    Destination IP      = 0x00000000 (0.0.0.0)

  TCP Header:
    Source Port          = 0x0401 (1025)
    Destination Port     = 0x000D (13)
    Sequence Number      = 0x05B8D000 (95997952)
    Ack Number           = 0x00000000 (0)
    Header Length        = 24
    Flags                = 0x02 (...S.)
    Window Size          = 0x2000 (8192)
    Checksum             = 0xE06A (57450)
    Urgent Ptr           = 0x0000 (0)
    Options              =
      0000: 02 04 02 00

  RAW DATA:
    0000: 45 00 00 2C 00 02 00 00-FE 06 FB 20 C0 A8 01 01
E.....
    0010: 00 00 00 00 00 04 01 00 0D-05 B8 D0 00 00 00 00
.....
    0020: 60 02 20 00 E0 6A 00 00-02 04 02 00
Press any key to continue...

```

39.5 Diagnostic

The diagnostic facility allows you to test the different aspects of your ZyWALL to determine if it is working properly. Menu 24.4 allows you to choose among various types of diagnostic tests to evaluate your system, as shown next.

Follow the procedure below to get to **Menu 24.4 - System Maintenance - Diagnostic**.

- 1 From the main menu, select option 24 to open **Menu 24 - System Maintenance**.
- 2 From this menu, select option 4. Diagnostic. This will open **Menu 24.4 - System Maintenance - Diagnostic**.

Figure 314 Menu 24.4: System Maintenance: Diagnostic

```

Menu 24.4 - System Maintenance - Diagnostic

TCP/IP
  1. Ping Host
  2. WAN DHCP Release
  3. WAN DHCP Renewal
  4. Internet Setup Test

System
  11. Reboot System

Enter Menu Selection Number:

WAN=
Host IP Address= N/A

```

39.5.1 WAN DHCP

DHCP functionality can be enabled on the LAN or WAN as shown in [Figure 315 on page 520](#). LAN DHCP has already been discussed. The ZyWALL can act either as a WAN DHCP client (**IP Address Assignment** field in menu 4 or menu 11.x.2 is **Dynamic** and the **Encapsulation** field in menu 4 or menu 11 is **Ethernet**) or **None**, (when you have a static IP). The **WAN Release** and **Renewal** fields in menu 24.4 conveniently allow you to release and/or renew the assigned WAN IP address, subnet mask and default gateway in a fashion similar to winipcfg.

Figure 315 WAN & LAN DHCP

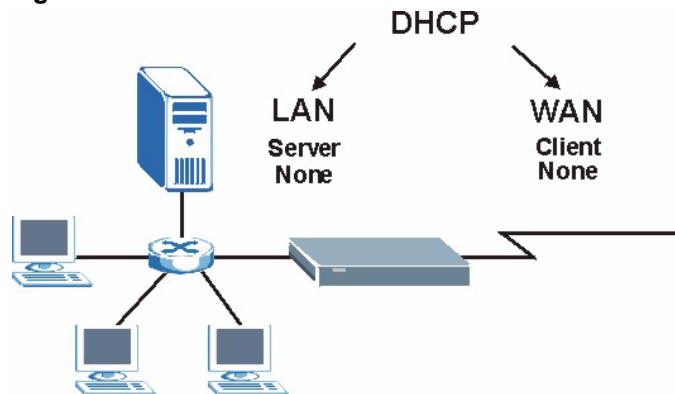

The following table describes the diagnostic tests available in menu 24.4 for your ZyWALL and associated connections.

Table 200 System Maintenance Menu Diagnostic

FIELD	DESCRIPTION
Ping Host	Enter 1 to ping any machine (with an IP address) on your LAN or WAN. Enter its IP address in the Host IP Address field below.
WAN DHCP Release	Enter 2 to release your WAN DHCP settings.
WAN DHCP Renewal	Enter 3 to renew your WAN DHCP settings.
Internet Setup Test	Enter 4 to test the Internet setup. You can also test the Internet setup in Menu 4 - Internet Access . Please refer to Chapter 30 on page 449 for more details. This feature is only available for dial-up connections using PPPoE or PPTP encapsulation.
Reboot System	Enter 11 to reboot the ZyWALL.
WAN	If you entered 2 or 3 in the Enter Menu Selection Number field, enter the number of the WAN port in this field.
Host IP Address	If you entered 1 in the Enter Menu Selection Number field, then enter the IP address of the computer you want to ping in this field.
Enter the number of the selection you would like to perform or press [ESC] to cancel.	

CHAPTER 40

Firmware and Configuration File Maintenance

This chapter tells you how to back up and restore your configuration file as well as upload new firmware and a new configuration file.

40.1 Introduction

Use the instructions in this chapter to change the ZyWALL's configuration file or upgrade its firmware. After you configure your ZyWALL, you can backup the configuration file to a computer. That way if you later misconfigure the ZyWALL, you can upload the backed up configuration file to return to your previous settings. You can alternately upload the factory default configuration file if you want to return the ZyWALL to the original default settings. The firmware determines the ZyWALL's available features and functionality. You can download new firmware releases from your nearest ZyXEL FTP site to use to upgrade your ZyWALL's performance.

40.2 Filename Conventions

The configuration file (often called the romfile or rom-0) contains the factory default settings in the menus such as password, DHCP Setup, TCP/IP Setup, etc. It arrives from ZyXEL with a "rom" filename extension. Once you have customized the ZyWALL's settings, they can be saved back to your computer under a filename of your choosing.

ZyNOS (ZyXEL Network Operating System sometimes referred to as the "ras" file) is the system firmware and has a "bin" filename extension. With many FTP and TFTP clients, the filenames are similar to those seen next.

```
ftp> put firmware.bin ras
```

This is a sample FTP session showing the transfer of the computer file " firmware.bin" to the ZyWALL.

```
ftp> get rom-0 config.cfg
```

This is a sample FTP session saving the current configuration to the computer file "config.cfg".

If your (T)FTP client does not allow you to have a destination filename different than the source, you will need to rename them as the ZyWALL only recognizes "rom-0" and "ras". Be sure you keep unaltered copies of both files for later use.

The following table is a summary. Please note that the internal filename refers to the filename on the ZyWALL and the external filename refers to the filename not on the ZyWALL, that is, on your computer, local network or FTP site and so the name (but not the extension) may vary. After uploading new firmware, see the **ZyNOS F/W Version** field in **Menu 24.2.1 - System Maintenance - Information** to confirm that you have uploaded the correct firmware version. The AT command is the command you enter after you press “y” when prompted in the SMT menu to go into debug mode.

Table 201 Filename Conventions

FILE TYPE	INTERNAL NAME	EXTERNAL NAME	DESCRIPTION
Configuration File	Rom-0	This is the configuration filename on the ZyWALL. Uploading the rom-0 file replaces the entire ROM file system, including your ZyWALL configurations, system-related data (including the default password), the error log and the trace log.	*.rom
Firmware	Ras	This is the generic name for the ZyNOS firmware on the ZyWALL.	*.bin

40.3 Backup Configuration

Note: The ZyWALL displays different messages explaining different ways to backup, restore and upload files in menus 24.5, 24.6, 24. 7.1 and 24.7.2 depending on whether you use the console port or Telnet.

Option 5 from **Menu 24 - System Maintenance** allows you to backup the current ZyWALL configuration to your computer. Backup is highly recommended once your ZyWALL is functioning properly. FTP is the preferred method for backing up your current configuration to your computer since it is faster. You can also perform backup and restore using menu 24 through the console port. Any serial communications program should work fine; however, you must use Xmodem protocol to perform the download/upload and you don't have to rename the files.

Please note that terms “download” and “upload” are relative to the computer. Download means to transfer from the ZyWALL to the computer, while upload means from your computer to the ZyWALL.

40.3.1 Backup Configuration

Follow the instructions as shown in the next screen.

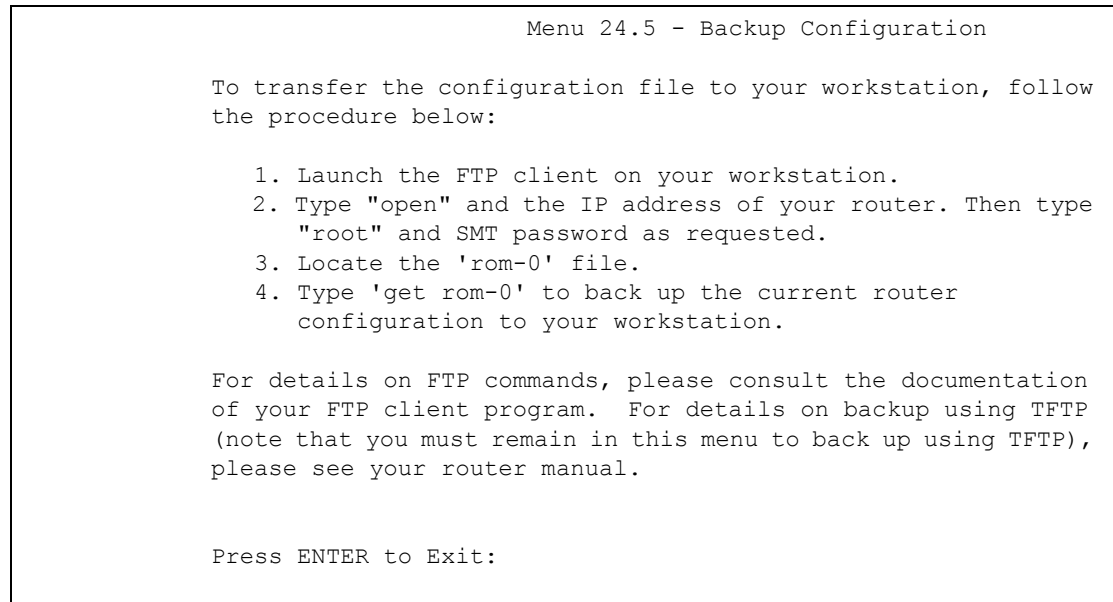
Figure 316 Telnet into Menu 24.5

40.3.2 Using the FTP Command from the Command Line

- 1 Launch the FTP client on your computer.
- 2 Enter “open”, followed by a space and the IP address of your ZyWALL.
- 3 Press [ENTER] when prompted for a username.
- 4 Enter your password as requested (the default is “1234”).
- 5 Enter “bin” to set transfer mode to binary.
- 6 Use “get” to transfer files from the ZyWALL to the computer, for example, “get rom-0 config.rom” transfers the configuration file on the ZyWALL to your computer and renames it “config.rom”. See earlier in this chapter for more information on filename conventions.
- 7 Enter “quit” to exit the ftp prompt.

40.3.3 Example of FTP Commands from the Command Line

Figure 317 FTP Session Example

```

331 Enter PASS command
Password:
230 Logged in
ftp> bin
200 Type I OK
ftp> get rom-0 zyxel.rom
200 Port command okay
150 Opening data connection for STOR ras
226 File received OK
ftp: 16384 bytes sent in 1.10Seconds
297.89Kbytes/sec.
ftp> quit

```

40.3.4 GUI-based FTP Clients

The following table describes some of the commands that you may see in GUI-based FTP clients.

Table 202 General Commands for GUI-based FTP Clients

COMMAND	DESCRIPTION
Host Address	Enter the address of the host server.
Login Type	Anonymous. This is when a user I.D. and password is automatically supplied to the server for anonymous access. Anonymous logins will work only if your ISP or service administrator has enabled this option. Normal. The server requires a unique User ID and Password to login.
Transfer Type	Transfer files in either ASCII (plain text format) or in binary mode. Configuration and firmware files should be transferred in binary mode
Initial Remote Directory	Specify the default remote directory (path).
Initial Local Directory	Specify the default local directory (path).

40.3.5 File Maintenance Over WAN

TFTP, FTP and Telnet over the WAN will not work when:

- 1** The firewall is active (turn the firewall off in menu 21.2 or create a firewall rule to allow access from the WAN).
- 2** You have disabled Telnet service in menu 24.11.
- 3** You have applied a filter in menu 3.1 (LAN) or in menu 11.5 (WAN) to block Telnet service.

- 4 The IP you entered in the **Secured Client IP** field in menu 24.11 does not match the client IP. If it does not match, the ZyWALL will disconnect the Telnet session immediately.
- 5 You have an SMT console session running.

40.3.6 Backup Configuration Using TFTP

The ZyWALL supports the up/downloading of the firmware and the configuration file using TFTP (Trivial File Transfer Protocol) over LAN. Although TFTP should work over WAN as well, it is not recommended.

To use TFTP, your computer must have both telnet and TFTP clients. To backup the configuration file, follow the procedure shown next.

- 1 Use telnet from your computer to connect to the ZyWALL and log in. Because TFTP does not have any security checks, the ZyWALL records the IP address of the telnet client and accepts TFTP requests only from this address.
- 2 Put the SMT in command interpreter (CI) mode by entering 8 in **Menu 24 – System Maintenance**.
- 3 Enter command “sys stdio 0” to disable the SMT timeout, so the TFTP transfer will not be interrupted. Enter command “sys stdio 5” to restore the five-minute SMT timeout (default) when the file transfer is complete.
- 4 Launch the TFTP client on your computer and connect to the ZyWALL. Set the transfer mode to binary before starting data transfer.
- 5 Use the TFTP client (see the example below) to transfer files between the ZyWALL and the computer. The file name for the configuration file is “rom-0” (rom-zero, not capital o).

Note that the telnet connection must be active and the SMT in CI mode before and during the TFTP transfer. For details on TFTP commands (see following example), please consult the documentation of your TFTP client program. For UNIX, use “get” to transfer from the ZyWALL to the computer and “binary” to set binary transfer mode.

40.3.7 TFTP Command Example

The following is an example TFTP command:

```
tftp [-i] host get rom-0 config.rom
```

Where “i” specifies binary image transfer mode (use this mode when transferring binary files), “host” is the ZyWALL IP address, “get” transfers the file source on the ZyWALL (rom-0, name of the configuration file on the ZyWALL) to the file destination on the computer and renames it config.rom.

40.3.8 GUI-based TFTP Clients

The following table describes some of the fields that you may see in GUI-based TFTP clients.

Table 203 General Commands for GUI-based TFTP Clients

COMMAND	DESCRIPTION
Host	Enter the IP address of the ZyWALL. 192.168.1.1 is the ZyWALL's default IP address when shipped.
Send/Fetch	Use "Send" to upload the file to the ZyWALL and "Fetch" to back up the file on your computer.
Local File	Enter the path and name of the firmware file (*.bin extension) or configuration file (*.rom extension) on your computer.
Remote File	This is the filename on the ZyWALL. The filename for the firmware is "ras" and for the configuration file, is "rom-0".
Binary	Transfer the file in binary mode.
Abort	Stop transfer of the file.

Refer to [Section 40.3.5 on page 526](#) to read about configurations that disallow TFTP and FTP over WAN.

40.3.9 Backup Via Console Port

Back up configuration via console port by following the HyperTerminal procedure shown next. Procedures using other serial communications programs should be similar.

- 1 Display menu 24.5 and enter "y" at the following screen.

Figure 318 System Maintenance: Backup Configuration

```
Ready to backup Configuration via Xmodem.
Do you want to continue (y/n):
```

- 2 The following screen indicates that the Xmodem download has started.

Figure 319 System Maintenance: Starting Xmodem Download Screen

```
You can enter ctrl-x to terminate operation any
time.
Starting XMODEM download...
```

- 3 Run the HyperTerminal program by clicking **Transfer**, then **Receive File** as shown in the following screen.

Figure 320 Backup Configuration Example

Type a location for storing the configuration file or click **Browse** to look for one.

Choose the **Xmodem** protocol.

Then click **Receive**.

- 4 After a successful backup you will see the following screen. Press any key to return to the SMT menu.

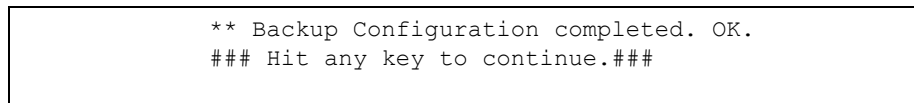
Figure 321 Successful Backup Confirmation Screen

40.4 Restore Configuration

This section shows you how to restore a previously saved configuration. Note that this function erases the current configuration before restoring a previous back up configuration; please do not attempt to restore unless you have a backup configuration file stored on disk.

FTP is the preferred method for restoring your current computer configuration to your ZyWALL since FTP is faster. Please note that you must wait for the system to automatically restart after the file transfer is complete.

Note: WARNING!

Do not interrupt the file transfer process as this may PERMANENTLY DAMAGE YOUR ZyWALL. When the Restore Configuration process is complete, the ZyWALL will automatically restart.

40.4.1 Restore Using FTP

For details about backup using (T)FTP please refer to earlier sections on FTP and TFTP file upload in this chapter.

Figure 322 Telnet into Menu 24.6

```
Menu 24.6 -- System Maintenance - Restore Configuration

To transfer the firmware and configuration file to your
workstation, follow the procedure below:

1. Launch the FTP client on your workstation.
2. Type "open" and the IP address of your router. Then type
"root" and SMT password as requested.
3. Type "put backupfilename rom-0" where backupfilename is the
name of your backup configuration file on your workstation
and rom-0 is the remote file name on the router. This
restores the configuration to your router.
4. The system reboots automatically after a successful file
transfer. For details on FTP commands, please consult the
documentation of your FTP client program.

For details on backup using TFTP (note that you must remain in
this menu to back up using TFTP), please see your router
manual.

Press ENTER to Exit:
```

- 1** Launch the FTP client on your computer.
- 2** Enter “open”, followed by a space and the IP address of your ZyWALL.
- 3** Press [ENTER] when prompted for a username.
- 4** Enter your password as requested (the default is “1234”).
- 5** Enter “bin” to set transfer mode to binary.
- 6** Find the “rom” file (on your computer) that you want to restore to your ZyWALL.
- 7** Use “put” to transfer files from the ZyWALL to the computer, for example, “put config.rom rom-0” transfers the configuration file “config.rom” on your computer to the ZyWALL. See earlier in this chapter for more information on filename conventions.
- 8** Enter “quit” to exit the ftp prompt. The ZyWALL will automatically restart after a successful restore process.

40.4.2 Restore Using FTP Session Example

Figure 323 Restore Using FTP Session Example

```
ftp> put config.rom rom-0
200 Port command okay
150 Opening data connection for STOR rom-0
226 File received OK
221 Goodbye for writing flash
ftp: 16384 bytes sent in 0.06Seconds 273.07Kbytes/sec.
ftp>quit
```

Refer to [Section 40.3.5 on page 526](#) to read about configurations that disallow TFTP and FTP over WAN.

40.4.3 Restore Via Console Port

Restore configuration via console port by following the HyperTerminal procedure shown next. Procedures using other serial communications programs should be similar.

- 1 Display menu 24.6 and enter “y” at the following screen.

Figure 324 System Maintenance: Restore Configuration

```
Ready to restore Configuration via Xmodem.
Do you want to continue (y/n):
```

- 2 The following screen indicates that the Xmodem download has started.

Figure 325 System Maintenance: Starting Xmodem Download Screen

```
Starting XMODEM download (CRC mode) ...CCCCCCCC
```

- 3 Run the HyperTerminal program by clicking **Transfer**, then **Send File** as shown in the following screen.

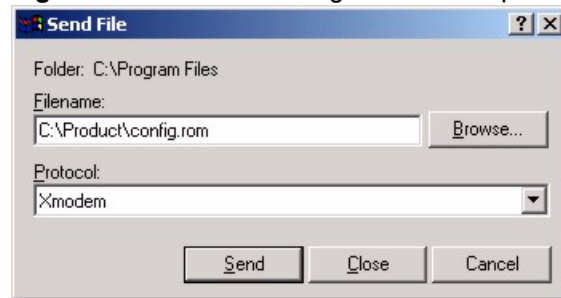
Figure 326 Restore Configuration Example

Type the configuration file's location, or click **Browse** to search for it.

Choose the **Xmodem** protocol.

Then click **Send**.

- 4 After a successful restoration you will see the following screen. Press any key to restart the ZyWALL and return to the SMT menu.

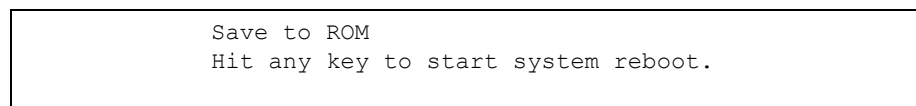
Figure 327 Successful Restoration Confirmation Screen

40.5 Uploading Firmware and Configuration Files

This section shows you how to upload firmware and configuration files. You can upload configuration files by following the procedure in [Section 40.4 on page 529](#) or by following the instructions in **Menu 24.7.2 - System Maintenance - Upload System Configuration File** (for console port).

Note: WARNING!

Do not interrupt the file transfer process as this may PERMANENTLY DAMAGE YOUR ZyWALL.

40.5.1 Firmware File Upload

FTP is the preferred method for uploading the firmware and configuration. To use this feature, your computer must have an FTP client.

When you telnet into the ZyWALL, you will see the following screens for uploading firmware and the configuration file using FTP.

Figure 328 Telnet Into Menu 24.7.1: Upload System Firmware

```
Menu 24.7.1 - System Maintenance - Upload System Firmware

To upload the system firmware, follow the procedure below:

    1. Launch the FTP client on your workstation.
    2. Type "open" and the IP address of your system. Then type
       "root" and SMT password as requested.
    3. Type "put firmwarefilename ras" where "firmwarefilename"
       is the name of your firmware upgrade file on your workstation
       and "ras" is the remote file name on the system.
    4. The system reboots automatically after a successful
       firmware upload.

For details on FTP commands, please consult the documentation
of your FTP client program. For details on uploading system
firmware using TFTP (note that you must remain on this menu to
upload system firmware using TFTP), please see your manual.

Press ENTER to Exit:
```

40.5.2 Configuration File Upload

You see the following screen when you telnet into menu 24.7.2.

Figure 329 Telnet Into Menu 24.7.2: System Maintenance

```
Menu 24.7.2 - System Maintenance - Upload System Configuration
File

To upload the system configuration file, follow the procedure
below:

    1. Launch the FTP client on your workstation.
    2. Type "open" and the IP address of your system. Then type
       "root" and SMT password as requested.
    3. Type "put configurationfilename rom-0" where
       "configurationfilename" is the name of your system
       configuration file on your workstation, which will be
       transferred to the "rom-0" file on the system.
    4. The system reboots automatically after the upload system
       configuration file process is complete.

For details on FTP commands, please consult the documentation
of your FTP client program. For details on uploading
configuration file using TFTP (note that you must remain on
this menu to upload configuration file using TFTP), please see
your manual.

Press ENTER to Exit:
```

To upload the firmware and the configuration file, follow these examples

40.5.3 FTP File Upload Command from the DOS Prompt Example

- 1 Launch the FTP client on your computer.
- 2 Enter “open”, followed by a space and the IP address of your ZyWALL.
- 3 Press [ENTER] when prompted for a username.
- 4 Enter your password as requested (the default is “1234”).
- 5 Enter “bin” to set transfer mode to binary.
- 6 Use “put” to transfer files from the computer to the ZyWALL, for example, “put firmware.bin ras” transfers the firmware on your computer (firmware.bin) to the ZyWALL and renames it “ras”. Similarly, “put config.rom rom-0” transfers the configuration file on your computer (config.rom) to the ZyWALL and renames it “rom-0”. Likewise “get rom-0 config.rom” transfers the configuration file on the ZyWALL to your computer and renames it “config.rom.” See earlier in this chapter for more information on filename conventions.
- 7 Enter “quit” to exit the ftp prompt.

40.5.4 FTP Session Example of Firmware File Upload

Figure 330 FTP Session Example of Firmware File Upload

```
331 Enter PASS command
Password:
230 Logged in
ftp> bin
200 Type I OK
ftp> put firmware.bin ras
200 Port command okay
150 Opening data connection for STOR ras
226 File received OK
ftp: 1103936 bytes sent in 1.10Seconds
297.89Kbytes/sec.
ftp> quit
```

More commands (found in GUI-based FTP clients) are listed earlier in this chapter.

Refer to [Section 40.3.5 on page 526](#) to read about configurations that disallow TFTP and FTP over WAN.

40.5.5 TFTP File Upload

The ZyWALL also supports the uploading of firmware files using TFTP (Trivial File Transfer Protocol) over LAN. Although TFTP should work over WAN as well, it is not recommended.

To use TFTP, your computer must have both telnet and TFTP clients. To transfer the firmware and the configuration file, follow the procedure shown next.

- 1 Use telnet from your computer to connect to the ZyWALL and log in. Because TFTP does not have any security checks, the ZyWALL records the IP address of the telnet client and accepts TFTP requests only from this address.
- 2 Put the SMT in command interpreter (CI) mode by entering 8 in **Menu 24 – System Maintenance**.
- 3 Enter the command “sys stdio 0” to disable the console timeout, so the TFTP transfer will not be interrupted. Enter “command sys stdio 5” to restore the five-minute console timeout (default) when the file transfer is complete.
- 4 Launch the TFTP client on your computer and connect to the ZyWALL. Set the transfer mode to binary before starting data transfer.
- 5 Use the TFTP client (see the example below) to transfer files between the ZyWALL and the computer. The file name for the firmware is “ras”.

Note that the telnet connection must be active and the ZyWALL in CI mode before and during the TFTP transfer. For details on TFTP commands (see following example), please consult the documentation of your TFTP client program. For UNIX, use “get” to transfer from the ZyWALL to the computer, “put” the other way around, and “binary” to set binary transfer mode.

40.5.6 TFTP Upload Command Example

The following is an example TFTP command:

```
tftp [-i] host put firmware.bin ras
```

Where “i” specifies binary image transfer mode (use this mode when transferring binary files), “host” is the ZyWALL’s IP address, “put” transfers the file source on the computer (firmware.bin – name of the firmware on the computer) to the file destination on the remote host (ras - name of the firmware on the ZyWALL).

Commands that you may see in GUI-based TFTP clients are listed earlier in this chapter.

40.5.7 Uploading Via Console Port

FTP or TFTP are the preferred methods for uploading firmware to your ZyWALL. However, in the event of your network being down, uploading files is only possible with a direct connection to your ZyWALL via the console port. Uploading files via the console port under normal conditions is not recommended since FTP or TFTP is faster. Any serial communications program should work fine; however, you must use the Xmodem protocol to perform the download/upload.

40.5.8 Uploading Firmware File Via Console Port

- 1 Select 1 from Menu 24.7 – System Maintenance – Upload Firmware to display Menu 24.7.1 - System Maintenance - Upload System Firmware, and then follow the instructions as shown in the following screen.

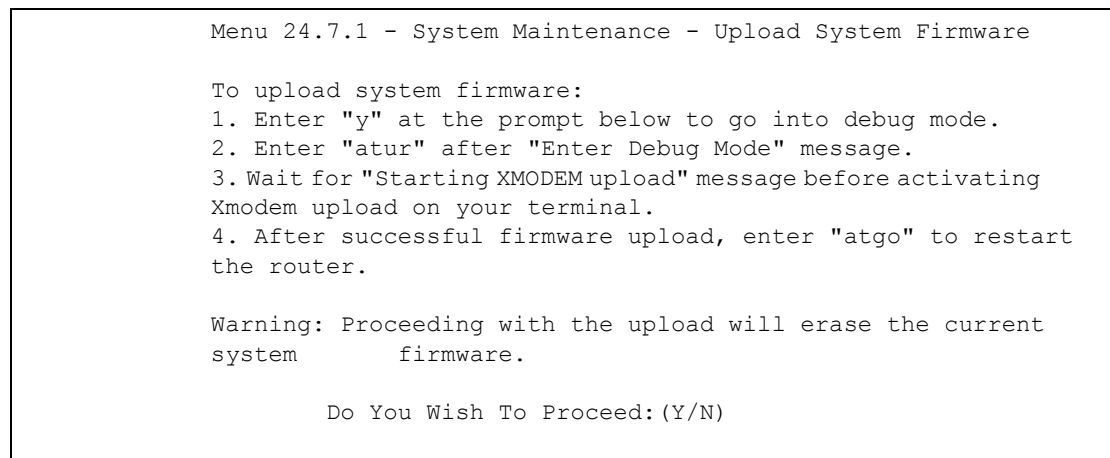
Figure 331 Menu 24.7.1 As Seen Using the Console Port

- 2 After the "Starting Xmodem upload" message appears, activate the Xmodem protocol on your computer. Follow the procedure as shown previously for the HyperTerminal program. The procedure for other serial communications programs should be similar.

40.5.9 Example Xmodem Firmware Upload Using HyperTerminal

Click **Transfer**, then **Send File** to display the following screen.

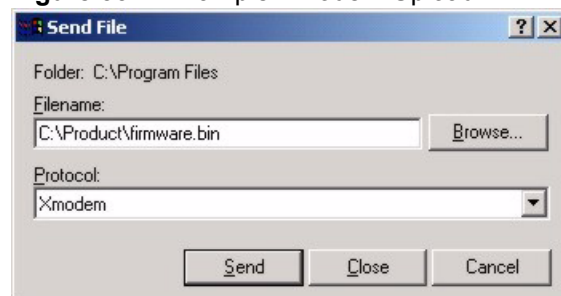
Figure 332 Example Xmodem Upload

After the firmware upload process has completed, the ZyWALL will automatically restart.

40.5.10 Uploading Configuration File Via Console Port

- 1 Select 2 from Menu 24.7 – System Maintenance – Upload Firmware to display Menu 24.7.2 - System Maintenance - Upload System Configuration File. Follow the instructions as shown in the next screen.

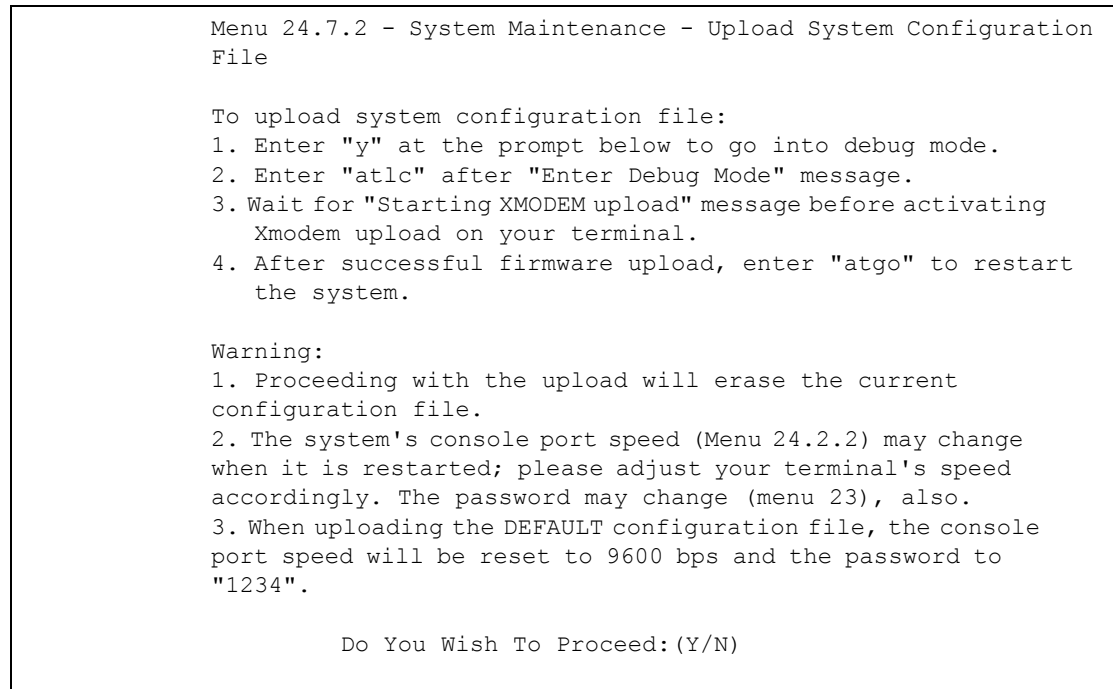
Figure 333 Menu 24.7.2 As Seen Using the Console Port

- 2 After the "Starting Xmodem upload" message appears, activate the Xmodem protocol on your computer. Follow the procedure as shown previously for the HyperTerminal program. The procedure for other serial communications programs should be similar.
- 3 Enter "atgo" to restart the ZyWALL.

40.5.11 Example Xmodem Configuration Upload Using HyperTerminal

Click **Transfer**, then **Send File** to display the following screen.

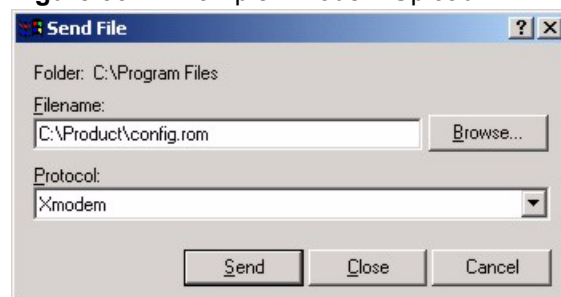
Figure 334 Example Xmodem Upload

After the configuration upload process has completed, restart the ZyWALL by entering "atgo".

CHAPTER 41

System Maintenance Menus 8 to 10

This chapter leads you through SMT menus 24.8 to 24.10.

41.1 Command Interpreter Mode

The Command Interpreter (CI) is a part of the main router firmware. The CI provides much of the same functionality as the SMT, while adding some low-level setup and diagnostic functions. Enter the CI from the SMT by selecting menu 24.8. Access can be by Telnet or by a serial connection to the console port, although some commands are only available with a serial connection. See the included disk or zyxel.com for more detailed information on CI commands. Enter 8 from **Menu 24 - System Maintenance**.

Note: Use of undocumented commands or misconfiguration can damage the unit and possibly render it unusable.

Figure 335 Command Mode in Menu 24

```
Menu 24 - System Maintenance

1. System Status
2. System Information and Console Port Speed
3. Log and Trace
4. Diagnostic
5. Backup Configuration
6. Restore Configuration
7. Upload Firmware
8. Command Interpreter Mode
9. Call Control
10. Time and Date Setting
11. Remote Management Setup

Enter Menu Selection Number:
```

41.1.1 Command Syntax

The command keywords are in `courier new` font.

Enter the command keywords exactly as shown, do not abbreviate.

The required fields in a command are enclosed in angle brackets <>.

The optional fields in a command are enclosed in square brackets [].

The | symbol means “or”.

For example,

```
sys filter netbios config <type> <on|off>
```

means that you must specify the type of netbios filter and whether to turn it on or off.

41.1.2 Command Usage

A list of commands can be found by typing `help` or `?` at the command prompt. Always type the full command. Type `exit` to return to the SMT main menu when finished.

Figure 336 Valid Commands

```
Copyright (c) 1994 - 2004 ZyXEL Communications Corp.
ras> ?
Valid commands are:
sys          ls          exit          device
ether       poe          pptp          aux
config      ip           ipsec         ppp
bridge      bm           certificates  cnm
8021x       radius
ras>
```

The following table describes some commands in this screen.

Table 204 Valid Commands

COMMAND	DESCRIPTION
sys	The system commands display device information and configure device settings.
exit	This command returns you to the SMT main menu.
ether	These commands display Ethernet information and configure Ethernet settings.
aux	These commands display dial backup information and control dial backup connections.
ip	These commands display IP information and configure IP settings.
ipsec	These commands display IPSec information and configure IPSec settings.
bridge	These commands display bridge information.
bm	These commands configure bandwidth management settings and display bandwidth management information.
certificates	These commands display certificate information and configure certificate settings.
8021x	These commands configure 802.1x settings and display 802.1x information.
radius	These commands display RADIUS information and configure RADIUS settings.

41.2 Call Control Support

The ZyWALL provides two call control functions: budget management and call history. Please note that this menu is only applicable when **Encapsulation** is set to **PPPoE** or **PPTP** in menu 4 or menu 11.1.

The budget management function allows you to set a limit on the total outgoing call time of the ZyWALL within certain times. When the total outgoing call time exceeds the limit, the current call will be dropped and any future outgoing calls will be blocked.

Call history chronicles preceding incoming and outgoing calls.

To access the call control menu, select option 9 in menu 24 to go to **Menu 24.9 - System Maintenance - Call Control**, as shown in the next table.

Figure 337 Call Control

```
Menu 24.9 - System Maintenance - Call Control

1.Budget Management
2.Call History

Enter Menu Selection Number:
```

41.2.1 Budget Management

Menu 24.9.1 shows the budget management statistics for outgoing calls. Enter 1 from **Menu 24.9 - System Maintenance - Call Control** to bring up the following menu.

Figure 338 Budget Management

Menu 24.9.1 - Budget Management		
Remote Node Total Period	Connection Time/Total Budget	Elapsed Time/
1.WAN_1	No Budget	No Budget
2.WAN_2	No Budget	No Budget
3.Dial	No Budget	No Budget
Reset Node (0 to update screen):		

The total budget is the time limit on the accumulated time for outgoing calls to a remote node. When this limit is reached, the call will be dropped and further outgoing calls to that remote node will be blocked. After each period, the total budget is reset. The default for the total budget is 0 minutes and the period is 0 hours, meaning no budget control. You can reset the accumulated connection time in this menu by entering the index of a remote node. Enter 0 to update the screen. The budget and the reset period can be configured in menu 11.1 for the remote node.

Table 205 Budget Management

FIELD	DESCRIPTION	EXAMPLE
Remote Node	Enter the index number of the remote node you want to reset (just one in this case)	1
Connection Time/ Total Budget	This is the total connection time that has gone by (within the allocated budget that you set in menu 11.1).	5/10 means that 5 minutes out of a total allocation of 10 minutes have lapsed.
Elapsed Time/Total Period	The period is the time cycle in hours that the allocation budget is reset (see menu 11.1.) The elapsed time is the time used up within this period.	0.5/1 means that 30 minutes out of the 1-hour time period has lapsed.
Enter "0" to update the screen or press [ESC] to return to the previous screen.		

41.2.2 Call History

This is the second option in **Menu 24.9 - System Maintenance - Call Control**. It displays information about past incoming and outgoing calls. Enter 2 from **Menu 24.9 - System Maintenance - Call Control** to bring up the following menu.

Figure 339 Call History

```

Menu 24.9.2 - Call History

      Phone Number   Dir   Rate #call  Max  Min  Total
1.
2.
3.
4.
5.
6.
7.
8.
9.
10.

Enter Entry to Delete(0 to exit):

```

The following table describes the fields in this screen.

Table 206 Call History

FIELD	DESCRIPTION
Phone Number	The PPPoE service names are shown here.
Dir	This shows whether the call was incoming or outgoing.
Rate	This is the transfer rate of the call.
#call	This is the number of calls made to or received from that telephone number.
Max	This is the length of time of the longest telephone call.
Min	This is the length of time of the shortest telephone call.
Total	This is the total length of time of all the telephone calls to/from that telephone number.
You may enter an entry number to delete it or "0" to exit.	

41.3 Time and Date Setting

The Real Time Chip (RTC) keeps track of the time and date. There is also a software mechanism to set the time manually or get the current time and date from an external server when you turn on your ZyWALL. Menu 24.10 allows you to update the time and date settings of your ZyWALL. The real time is then displayed in the ZyWALL error logs and firewall logs.

Select menu 24 in the main menu to open **Menu 24 - System Maintenance**, as shown next.

Figure 340 Menu 24: System Maintenance

```
Menu 24 - System Maintenance

1. System Status
2. System Information and Console Port Speed
3. Log and Trace
4. Diagnostic
5. Backup Configuration
6. Restore Configuration
7. Upload Firmware
8. Command Interpreter Mode
9. Call Control
10. Time and Date Setting
11. Remote Management Setup

Enter Menu Selection Number:
```

Enter 10 to go to **Menu 24.10 - System Maintenance - Time and Date Setting** to update the time and date settings of your ZyWALL as shown in the following screen.

Figure 341 Menu 24.10 System Maintenance: Time and Date Setting

```
Menu 24.10 - System Maintenance - Time and Date Setting

Time Protocol= NTP (RFC-1305)
Time Server Address= a.ntp.alphazed.net

Current Time:                08 : 24 : 26
New Time (hh:mm:ss):        N/A  N/A  N/A

Current Date:                2004 - 07 - 01
New Date (yyyy-mm-dd):      N/A   N/A  N/A

Time Zone= GMT

Daylight Saving= No
Start Date (mm-nth-week-hr): Jan. - 1st - Wed. - 00
End Date (mm-nth-week-hr):  Jan. - 1st - Wed. - 00

Press ENTER to Confirm or ESC to Cancel:
```

The following table describes the fields in this screen.

Table 207 Menu 24.10 System Maintenance: Time and Date Setting

FIELD	DESCRIPTION
Time Protocol	<p>Enter the time service protocol that your timeserver uses. Not all time servers support all protocols, so you may have to check with your ISP/network administrator or use trial and error to find a protocol that works. The main differences between them are the format.</p> <p>Daytime (RFC 867) format is day/month/year/time zone of the server.</p> <p>Time (RFC-868) format displays a 4-byte integer giving the total number of seconds since 1970/1/1 at 0:0:0.</p> <p>The default, NTP (RFC-1305), is similar to Time (RFC-868).</p> <p>Select Manual to enter the new time and new date manually.</p>
Time Server Address	Enter the IP address or domain name of your timeserver. Check with your ISP/network administrator if you are unsure of this information. The default is tick.stdtime.gov.tw
Current Time	This field displays an updated time only when you reenter this menu.
New Time	Enter the new time in hour, minute and second format. This field is available when you select Manual in the Time Protocol field.
Current Date	This field displays an updated date only when you reenter this menu.
New Date	Enter the new date in year, month and day format. This field is available when you select Manual in the Time Protocol field.
Time Zone	Press [SPACE BAR] and then [ENTER] to set the time difference between your time zone and Greenwich Mean Time (GMT).
Daylight Saving	Daylight Saving Time is a period from late spring to early fall when many countries set their clocks ahead of normal local time by one hour to give more daylight time in the evenings. If you use daylight savings time, then choose Yes .
Start Date (mm-nth-week-hr)	<p>Configure the day and time when Daylight Saving Time starts if you selected Yes in the Daylight Saving field. The hr field uses the 24 hour format. Here are a couple of examples:</p> <p>Daylight Saving Time starts in most parts of the United States on the first Sunday of April. Each time zone in the United States starts using Daylight Saving Time at 2 A.M. local time. So in the United States you would select Apr., 1st, Sun. and type 02 in the hr field.</p> <p>Daylight Saving Time starts in the European Union on the last Sunday of March. All of the time zones in the European Union start using Daylight Saving Time at the same moment (1 A.M. GMT or UTC). So in the European Union you would select Mar., Last, Sun. The time you type in the hr field depends on your time zone. In Germany for instance, you would type 02 because Germany's time zone is one hour ahead of GMT or UTC (GMT+1).</p>

Table 207 Menu 24.10 System Maintenance: Time and Date Setting

FIELD	DESCRIPTION
End Date (mm-nth-week-hr)	<p>Configure the day and time when Daylight Saving Time ends if you selected Yes in the Daylight Saving field. The hr field uses the 24 hour format. Here are a couple of examples:</p> <p>Daylight Saving Time ends in the United States on the last Sunday of October. Each time zone in the United States stops using Daylight Saving Time at 2 A.M. local time. So in the United States you would select Oct., Last, Sun. and type 02 in the hr field.</p> <p>Daylight Saving Time ends in the European Union on the last Sunday of October. All of the time zones in the European Union stop using Daylight Saving Time at the same moment (1 A.M. GMT or UTC). So in the European Union you would select Oct., Last, Sun. The time you type in the hr field depends on your time zone. In Germany for instance, you would type 02 because Germany's time zone is one hour ahead of GMT or UTC (GMT+1).</p>
Once you have filled in this menu, press [ENTER] at the message "Press ENTER to Confirm or ESC to Cancel" to save your configuration, or press [ESC] to cancel.	

41.3.1 Resetting the Time

The ZyWALL resets the time in the following instances:

- On leaving menu 24.10 after making changes.
- When the ZyWALL starts up.
- 24-hour intervals after starting.

CHAPTER 42

Remote Management

This chapter covers remote management found in SMT menu 24.11.

42.1 Remote Management

Remote management allows you to determine which services/protocols can access which ZyWALL interface (if any) from which computers.

You may manage your ZyWALL from a remote location via:

- Internet (WAN only)
- LAN only
- DMZ only
- ALL (LAN, WAN and DMZ)
- Neither (Disable)

Note: When you Choose **WAN only** or **ALL** (LAN & WAN&DMZ), you still need to configure a firewall rule to allow access.

To disable remote management of a service, select **Disable** in the corresponding **Server Access** field.

Enter 11 from menu 24 to bring up **Menu 24.11 - Remote Management Control**.

Figure 342 Menu 24.11 – Remote Management Control

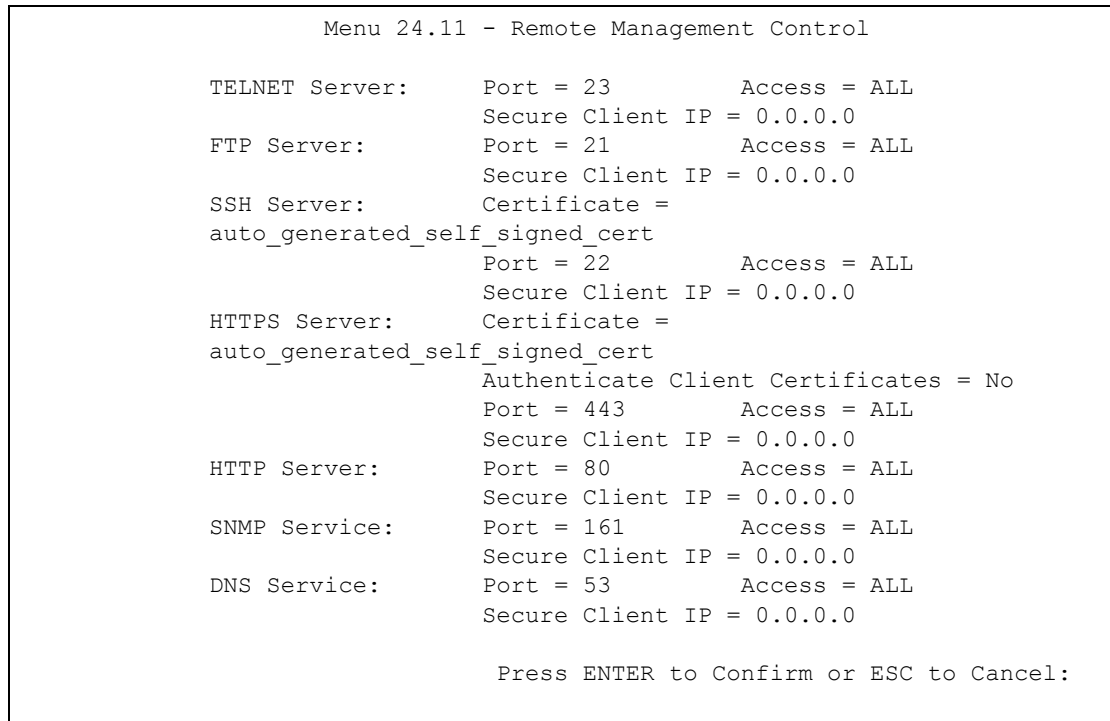

The following table describes the fields in this screen.

Table 208 Menu 24.11 – Remote Management Control

FIELD	DESCRIPTION
Telnet Server FTP Server SSH Server HTTPS Server HTTP Server SNMP Service DNS Service	Each of these read-only labels denotes a service that you may use to remotely manage the ZyWALL.
Port	This field shows the port number for the service or protocol. You may change the port number if needed, but you must use the same port number to access the ZyWALL.
Access	Select the access interface (if any) by pressing [SPACE BAR], then [ENTER] to choose from: LAN only , WAN only , DMZ only , ALL or Disable .
Secure Client IP	The default 0.0.0.0 allows any client to use this service to remotely manage the ZyWALL. Enter an IP address to restrict access to a client with a matching IP address.
Certificate	Press [SPACE BAR] and then [ENTER] to select the certificate that the ZyWALL will use to identify itself. The ZyWALL is the SSL server and must always authenticate itself to the SSL client (the computer which requests the HTTPS connection with the ZyWALL).

Table 208 Menu 24.11 – Remote Management Control (continued)

FIELD	DESCRIPTION
Authenticate Client Certificates	Select Yes by pressing [SPACE BAR], then [ENTER] to require the SSL client to authenticate itself to the ZyWALL by sending the ZyWALL a certificate. To do that the SSL client must have a CA-signed certificate from a CA that has been imported as a trusted CA on the ZyWALL (see Appendix K on page 645 for details).
Once you have filled in this menu, press [ENTER] at the message "Press ENTER to Confirm or ESC to Cancel" to save your configuration, or press [ESC] to cancel.	

42.1.1 Remote Management Limitations

Remote management over LAN or WAN will not work when:

- 1** A filter in menu 3.1 (LAN) or in menu 11.5 (WAN) is applied to block a Telnet, FTP or Web service.
- 2** You have disabled that service in menu 24.11.
- 3** The IP address in the **Secured Client IP** field (menu 24.11) does not match the client IP address. If it does not match, the ZyWALL will disconnect the session immediately.
- 4** There is an SMT console session running.
- 5** There is already another remote management session with an equal or higher priority running. You may only have one remote management session running at one time.
- 6** There is a firewall rule that blocks it.

CHAPTER 43

IP Policy Routing

This chapter covers setting and applying policies used for IP routing.

43.1 IP Routing Policy Summary

Menu 25 shows the summary of a policy rule, including the criteria and the action of a single policy, and whether a policy is active or not. Each policy contains two lines. The former part is the criteria of the incoming packet and the latter is the action. Between these two parts, separator "|" means the action is taken on criteria matched and separator "=" means the action is taken on criteria not matched.

Figure 343 Menu 25: Sample IP Routing Policy Summary

```

Menu 25 - IP Routing Policy Summary

#   A                               Criteria/Action
--- - -----
001 N SA=1.1.1.1-1.1.1.1 DA=2.2.2.2-2.2.2.5
    SP=20-25 DP=20-25 P=6 T=NM PR=0
|GW=192.168.1.1 T=MT PR=0
002 N _____
003 N _____
004 N _____
005 N _____
006 N _____

                Select Command= None           Select Rule= N/A
                Press ENTER to Confirm or ESC to Cancel:

Press Space Bar to Toggle.

```

The following table describes the fields in this screen.

Table 209 Menu 25: Sample IP Routing Policy Summary

FIELD	DESCRIPTION
#	This is the policy index number.
A	This displays whether a policy is active (Y) or not (N).

Table 209 Menu 25: Sample IP Routing Policy Summary (continued)

FIELD	DESCRIPTION
Criteria/Action	This displays the details about to which packets the policy applies and how the policy has the ZyWALL handle those packets. Refer to Table 210 on page 552 for detailed information.
Select Command	<p>Press [SPACE BAR] to choose from None, Edit, Delete, Go To Rule, Next Page or Previous Page and then press [ENTER]. You must select a rule in the next field when you choose the Edit, Delete or Go To commands.</p> <p>Select None and then press [ENTER] to go to the "Press ENTER to Confirm..." prompt.</p> <p>Use Edit to create or edit a rule. Use Delete to remove a rule. To edit or delete a rule, first make sure you are on the correct page. When a rule is deleted, subsequent rules do not move up in the page list.</p> <p>Use Go To Rule to view the page where your desired rule is listed.</p> <p>Select Next Page or Previous Page to view the next or previous page of rules (respectively).</p>
Select Rule	Type the policy index number you wish to edit or delete and then press [ENTER].
When you have completed this menu, press [ENTER] at the prompt "Press ENTER to Confirm..." to save your configuration, or press [ESC] at any time to cancel.	

Table 210 IP Routing Policy Setup

ABBREVIATION	MEANING
Criterion SA	Source IP Address
SP	Source Port
DA	Destination IP Address
DP	Destination Port
P	IP layer 4 protocol number (TCP=6, UDP=17...)
T	Type of service of incoming packet
PR	Precedence of incoming packet
Action GW	Gateway IP address
T	Outgoing Type of service
P	Outgoing Precedence
Service NM	Normal
MD	Minimum Delay
MT	Maximum Throughput
MR	Maximum Reliability
MC	Minimum Cost

43.2 IP Routing Policy Setup

To setup a routing policy, perform the following procedures:

- 1 Type 25 in the main menu to open **Menu 25 - IP Routing Policy Summary**.
- 2 Select **Edit** in the **Select Command** field; type the index number of the rule you want to configure in the **Select Rule** field and press [ENTER] to open **Menu 25.1 - IP Routing Policy Setup** (see the next figure).

Figure 344 Menu 25.1: IP Routing Policy Setup

```

Menu 25.1 - IP Routing Policy Setup

Rule Index= 1                               Active= Yes
Criteria:
  IP Protocol      = 6
  Type of Service= Normal                    Packet length= 40
  Precedence      = 0                       Len Comp= Equal
Source:
  addr start= 1.1.1.1                       end= 1.1.1.1
  port start= 20                             end= 25
Destination:
  addr start= 2.2.2.2                       end= 2.2.2.5
  port start= 20                             end= 25
Action= Matched
  Gateway Type= IP Address
  Gateway addr  = 192.168.1.1               Redirect packet= N/A
  Type of Service= Max Thruput             Log= No
  Precedence    = 0
Edit policy to packets received from= No

                                Press ENTER to Confirm or ESC to Cancel:

```

The following table describes the fields in this screen.

Table 211 Menu 25.1: IP Routing Policy Setup

FIELD	DESCRIPTION
Rule Index	This is the index number of the routing policy selected in Menu 25 - IP Routing Policy Summary .
Active	Press [SPACE BAR] and then [ENTER] to select Yes to activate the policy.
Criteria	
IP Protocol	Enter a number that represents an IP layer 4 protocol, for example, UDP=17, TCP=6, ICMP=1 and Don't care=0.
Type of Service	Prioritize incoming network traffic by choosing from Don't Care, Normal, Min Delay, Max Thruput or Max Reliable .
Precedence	Precedence value of the incoming packet. Press [SPACE BAR] and then [ENTER] to select a value from 0 to 7 or Don't Care .
Packet Length	Type the length of incoming packets (in bytes). The operators in the Len Comp (next field) apply to packets of this length.
Len Comp	Press [SPACE BAR] and then [ENTER] to choose from Equal, Not Equal, Less, Greater, Less or Equal or Greater or Equal .
Source	
addr start / end	Source IP address range from start to end.

Table 211 Menu 25.1: IP Routing Policy Setup

FIELD	DESCRIPTION
port start / end	Source port number range from start to end; applicable only for TCP/UDP.
Destination	
addr start / end	Destination IP address range from start to end.
port start / end	Destination port number range from start to end; applicable only for TCP/UDP.
Action	Specifies whether action should be taken on criteria Matched or Not Matched.
Gateway Type	Press [SPACE BAR] and then [ENTER] to select IP Address and enter the IP address of the gateway if you want to specify the IP address of the gateway. The gateway is an immediate neighbor of your ZyWALL that will forward the packet to the destination. The gateway must be a router on the same segment as your ZyWALL's LAN or WAN port. Press [SPACE BAR] and then [ENTER] to select Remote Node to have the ZyWALL send traffic that matches the policy route through a specific WAN port.
Gateway addr	This field displays if you selected IP Address in the Gateway Type field. Defines the outgoing gateway address. The gateway must be on the same subnet as the ZYWALL if it is on the LAN, otherwise, the gateway must be the IP address of a remote node. The default gateway is specified as 0.0.0.0.
Remote Node Idx	This field displays if you selected Remote Node in the Gateway Type field. Type 1 for WAN port 1 or 2 for WAN port 2.
Redirect Packet	This field applies if you selected Remote Node in the Gateway Type field. Press [SPACE BAR] and then [ENTER] to select Yes to have the ZyWALL send traffic that matches the policy route through the other WAN interface if it cannot send the traffic through the WAN interface you selected.
Type of Service	Set the new TOS value of the outgoing packet. Prioritize incoming network traffic by choosing Don't Care , Normal , Min Delay , Max Thruput , Max Reliable or Min Cost .
Precedence	Set the new outgoing packet precedence value. Values are 0 to 7 or Don't Care .
Log	Press [SPACE BAR] and then [ENTER] to select Yes to make an entry in the system log when a policy is executed.
Edit policy to packets received from	Press [SPACE BAR] and then [ENTER] to select Yes or No (default). Select Yes to configure Menu 25.1.1: IP Routing Policy Setup discussed next.
When you have completed this menu, press [ENTER] at the prompt "Press [ENTER] to confirm or [ESC] to cancel" to save your configuration or press [ESC] to cancel and go back to the previous screen.	

43.2.1 Applying Policy to Packets

To apply the policy to packets received on the selected interface(s), go to **Menu 25.1: IP Routing Policy Setup** and press [SPACE BAR] to select **Yes** in the **Edit policy to packets received from** field. Press [ENTER] to display **Menu 25.1.1 - IP Routing Policy Setup** (shown next).

Figure 345 Menu 25.1.1: IP Routing Policy Setup

```

Menu 25.1.1 - IP Routing Policy Setup

Apply policy to packets received from:
LAN= No
DMZ= No
ALL WAN= Yes
Selected Remote Node index= N/A

Press ENTER to Confirm or ESC to Cancel:

```

The following table describes the fields in this screen.

Table 212 Menu 25.1.1: IP Routing Policy Setup

FIELD	DESCRIPTION
LAN/DMZ/ALL WAN	Press [SPACE BAR] to select Yes or No . Choose Yes and press [ENTER] to apply the policy to packets received on the specific interface(s).
Selected Remote Node index	If you select No in the ALL WAN field, enter the number of the WAN port.
When you have completed this menu, press [ENTER] at the prompt "Press ENTER to Confirm..." to save your configuration, or press [ESC] at any time to cancel.	

43.3 IP Policy Routing Example

If a network has both Internet and remote node connections, you can route Web packets to the Internet using one policy and route FTP packets to a remote network using another policy. See the next figure.

Route 1 represents the default IP route and route 2 represents the configured IP route.

Figure 346 Example of IP Policy Routing

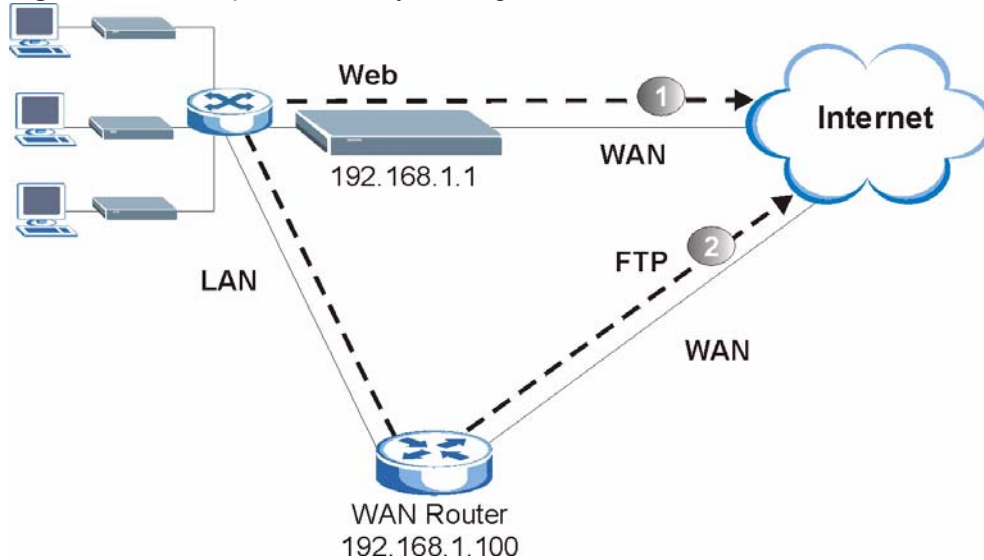

To force Web packets coming from clients with IP addresses of 192.168.1.33 to 192.168.1.64 to be routed to the Internet via the WAN port of the ZyWALL, follow the steps as shown next.

- 1 Create a rule in **Menu 25.1 - IP Routing Policy Setup** as shown next.

Figure 347 IP Routing Policy Example 1

```

Menu 25.1 - IP Routing Policy Setup

Rule Index= 1                               Active= Yes
Criteria:
  IP Protocol      = 6
  Type of Service= Don't Care                 Packet length= 10
  Precedence      = Don't Care                 Len Comp= Equal
Source:
  addr start= 192.168.1.33                    end= 192.168.1.64
  port start= 0                                end= N/A
Destination:
  addr start= 0.0.0.0                          end= N/A
  port start= 80                               end= 80
Action= Matched
  Gateway Type= IP Address
  Gateway addr  = 192.168.1.1                  Redirect packet= N/A
  Type of Service= Max Thruput                 Log= No
  Precedence    = 0
Edit policy to packets received from= No

Press ENTER to Confirm or ESC to Cancel:
    
```

- 2 Select **Yes** in the **LAN** field in menu 25.1.1 to apply the policy to packets received on the LAN port.
- 3 Check **Menu 25 - IP Routing Policy Summary** to see if the rule is added correctly.

- 4** Create another rule in menu 25.1 for this rule to route packets from any host (IP=0.0.0.0 means any host) with protocol TCP and port FTP access through another gateway (192.168.1.100).

Figure 348 IP Routing Policy Example 2

```

Menu 25.1 - IP Routing Policy Setup

Rule Index= 2                               Active= No
Criteria:
  IP Protocol      = 6
  Type of Service= Don't Care                Packet length= 10
  Precedence      = Don't Care                Len Comp= Equal
Source:
  addr start= 0.0.0.0                        end= N/A
  port start= 0                               end= N/A
Destination:
  addr start= 0.0.0.0                        end= N/A
  port start= 20                             end= 21
Action= Matched
  Gateway Type= IP Address
  Gateway addr  = 192.168.1.100              Redirect packet= N/A
  Type of Service= Don't Care              Log= No
  Precedence      = Don't Care
Edit policy to packets received from= No

                                Press ENTER to Confirm or ESC to Cancel:

```

- 5** Select **Yes** in the **LAN** field in menu 25.1.1 to apply the policy to packets received on the LAN port.
- 6** Check **Menu 25 - IP Routing Policy Summary** to see if the rule is added correctly.

CHAPTER 44

Call Scheduling

Call scheduling allows you to dictate when a remote node should be called and for how long.

44.1 Introduction to Call Scheduling

The call scheduling feature allows the ZyWALL to manage a remote node and dictate when a remote node should be called and for how long. This feature is similar to the scheduler in a videocassette recorder (you can specify a time period for the VCR to record). You can apply up to 4 schedule sets in **Menu 11.1 - Remote Node Profile**. From the main menu, enter **26** to access **Menu 26 - Schedule Setup** as shown next.

Figure 349 Schedule Setup

Menu 26 - Schedule Setup			
Schedule Set #	Name	Schedule Set #	Name
1	_____	7	_____
2	_____	8	_____
3	_____	9	_____
4	_____	10	_____
5	_____	11	_____
6	_____	12	_____

Enter Schedule Set Number to Configure= 0
 Edit Name= N/A
 Press ENTER to Confirm or ESC to Cancel:

Lower numbered sets take precedence over higher numbered sets thereby avoiding scheduling conflicts. For example, if sets 1, 2, 3 and 4 are applied in the remote node, then set 1 will take precedence over set 2, 3 and 4 as the ZyWALL, by default, applies the lowest numbered set first. Set 2 will take precedence over set 3 and 4, and so on.

You can design up to 12 schedule sets but you can only apply up to four schedule sets for a remote node.

Note: To delete a schedule set, enter the set number and press [SPACE BAR] and then [ENTER] or [DEL] in the Edit Name field.

To set up a schedule set, select the schedule set you want to setup from menu 26 (1-12) and press [ENTER] to see **Menu 26.1 - Schedule Set Setup** as shown next.

Figure 350 Schedule Set Setup

```

Menu 26.1 - Schedule Set Setup

Active= Yes
How Often= Once
Start Date (yyyy/mm/dd) = 2000 - 01 - 01
Once:
    Date (yyyy/mm/dd) = 2000 - 01 - 01
Weekdays:
    Sunday= N/A
    Monday= N/A
    Tuesday= N/A
    Wednesday= N/A
    Thursday= N/A
    Friday= N/A
    Saturday= N/A
Start Time (hh:mm) = 00 : 00
Duration (hh:mm) = 00 : 00
Action= Forced On

Press ENTER to Confirm or ESC to Cancel:
Press Space Bar to Toggle
    
```

If a connection has been already established, your ZyWALL will not drop it. Once the connection is dropped manually or it times out, then that remote node can't be triggered up until the end of the **Duration**.

Table 213 Schedule Set Setup

FIELD	DESCRIPTION
Active	Press [SPACE BAR] to select Yes or No . Choose Yes and press [ENTER] to activate the schedule set.
How Often	Should this schedule set recur weekly or be used just once only? Press [SPACE BAR] and then [ENTER] to select Once or Weekly . Both these options are mutually exclusive. If Once is selected, then all weekday settings are N/A . When Once is selected, the schedule rule deletes automatically after the scheduled time elapses.
Start Date	Enter the start date when you wish the set to take effect in year -month-date format. Valid dates are from the present to 2036-February-5.
Once:	
Date	If you selected Once in the How Often field above, then enter the date the set should activate here in year-month-date format.
Weekdays:	
Day	If you selected Weekly in the How Often field above, then select the day(s) when the set should activate (and recur) by going to that day(s) and pressing [SPACE BAR] to select Yes , then press [ENTER].
Start Time	Enter the start time when you wish the schedule set to take effect in hour-minute format.
Duration	The duration determines how long the ZyWALL is to apply the action configured in the Action field. Enter the maximum length of time in hour-minute format.

Table 213 Schedule Set Setup (continued)

FIELD	DESCRIPTION
Action	<p>Forced On means that the connection is maintained whether or not there is a demand call on the line and will persist for the time period specified in the Duration field.</p> <p>Forced Down means that the connection is blocked whether or not there is a demand call on the line.</p> <p>Enable Dial-On-Demand means that this schedule permits a demand call on the line.</p> <p>Disable Dial-On-Demand means that this schedule prevents a demand call on the line.</p>
When you have completed this menu, press [ENTER] at the prompt "Press ENTER to Confirm..." to save your configuration, or press [ESC] at any time to cancel.	

Once your schedule sets are configured, you must then apply them to the desired remote node(s). Enter 11 from the Main Menu and then enter the target remote node index. Press [SPACE BAR] and then [ENTER] to select **PPPoE** in the **Encapsulation** field to make the schedule sets field available as shown next.

Figure 351 Applying Schedule Set(s) to a Remote Node (PPPoE)

```

Menu 11.1 - Remote Node Profile

Rem Node Name= ChangeMe      Route= IP
Active= Yes

Encapsulation= PPPoE         Edit IP= No
Service Type= Standard       Telco Option:
Service Name=                 Allocated Budget (min)= 0
Outgoing=                     Period(hr)= 0
My Login=                     Schedules= 1,2,3,4
My Password= *****         Nailed-Up Connection= No
Authen= CHAP/PAP

Session Options:
Edit Filter Sets= No
Idle Timeout(sec)= 100

Press ENTER to Confirm or ESC to Cancel:

```

You can apply up to four schedule sets, separated by commas, for one remote node. Change the schedule set numbers to your preference(s).

Figure 352 Applying Schedule Set(s) to a Remote Node (PPTP)

```
Menu 11.1 - Remote Node Profile

Rem Node Name= ChangeMe           Route= IP
Active= Yes

Encapsulation= PPTP               Edit IP= No
Service Type= Standard           Telco Option:
                                   Allocated Budget(min)= 0
                                   Period(hr)= 0
                                   Schedules= 1,2,3,4
                                   Nailed-up Connections= No

Outgoing=
  My Login=
  My Password= *****
  Retype to Confirm= *****
  Authen= CHAP/PAP
PPTP:
  My IP Addr=
  My IP Mask=
  Server IP Addr=
  Connection ID/Name=

Session Options:
  Edit Filter Sets= No
  Idle Timeout(sec)= 100

Press ENTER to Confirm or ESC to Cancel:
```

CHAPTER 45

Troubleshooting

This chapter covers potential problems and possible remedies. After each problem description, some instructions are provided to help you to diagnose and to solve the problem. Please see our included disk for further information.

45.1 Problems Starting Up the ZyWALL

Table 214 Troubleshooting the Start-Up of Your ZyWALL

PROBLEM	CORRECTIVE ACTION	
None of the LEDs turn on when you turn on the ZyWALL.	Make sure that you have the included power adaptor or cord connected to the ZyWALL and to an appropriate power source.	
	If the error persists, you may have a hardware problem. In this case, you should contact your vendor.	
Cannot access the ZyWALL via the console port.	1. Check to see if the ZyWALL is connected to your computer's console port.	
	2. Check to see if the communications program is configured correctly. The communications software should be configured as follows:	VT100 terminal emulation
		9600 bps is the default speed on leaving the factory. Try other speeds in case the speed has been changed.
		No parity, 8 data bits, 1 stop bit, data flow set to none.

45.2 Problems with the LAN Interface

Table 215 Troubleshooting the LAN Interface

PROBLEM	CORRECTIVE ACTION
Cannot access the ZyWALL from the LAN.	Check your Ethernet cable type and connections. Refer to the Quick Start Guide for LAN connection instructions.
	Make sure the computer's Ethernet adapter is installed and functioning properly.

Table 215 Troubleshooting the LAN Interface (continued)

PROBLEM	CORRECTIVE ACTION
Cannot ping any computer on the LAN.	Check the 10M/100M LAN LEDs on the front panel. One of these LEDs should be on. If they are both off, check the cables between your ZyWALL and hub or the station.
	Verify that the IP address and the subnet mask of the ZyWALL and the computers are on the same subnet.
Cannot access the web configurator.	<p>You may also need to clear your Internet browser's cache.</p> <p>In Internet Explorer, click Tools and then Internet Options to open the Internet Options screen.</p> <p>In the General tab, click Delete Files. In the pop-up window, select the Delete all offline content check box and click OK. Click OK in the Internet Options screen to close it.</p> <p>If you disconnect your computer from one device and connect it to another device that has the same IP address, your computer's ARP (Address Resolution Protocol) table may contain an entry that maps the management IP address to the previous device's MAC address.</p> <p>In Windows, use arp -d at the command prompt to delete all entries in your computer's ARP table.</p>

45.3 Problems with the DMZ Interface

Table 216 Troubleshooting the DMZ Interface

PROBLEM	CORRECTIVE ACTION
Cannot access servers on the DMZ from the LAN.	Check your Ethernet cable type and connections. Refer to the Quick Start Guide for DMZ connection instructions.
	Make sure the Ethernet adapters on the LAN computer and the DMZ server are installed and functioning properly.
	Verify that the IP address of the DMZ port and the LAN port are on separate subnets.
	Make sure that NAT is configured for your DMZ servers.
Cannot ping any computer on the DMZ.	Check the 10M/100M DMZ LEDs on the front panel. One of these LEDs should be on. If they are both off, check the cables between your ZyWALL and hub or the station.
	Verify that the IP address and the subnet mask of the ZyWALL and the servers are on the same subnet.

45.4 Problems with the WAN Interface

Table 217 Troubleshooting the WAN Interface

PROBLEM	CORRECTIVE ACTION
Cannot get WAN IP address from the ISP.	The ISP provides the WAN IP address after authentication. Authentication may be through the user name and password, the MAC address or the host name. Use the following corrective actions to make sure the ISP can authenticate your connection.
	You need a user name and password if you're using PPPoE or PPTP encapsulation. Make sure that you have entered the correct Service Type , User Name and Password (the user name and password are case sensitive). Refer to Chapter 7 on page 131 or Chapter 30 on page 449
	If your ISP requires MAC address authentication, you should clone the MAC address from your computer on the LAN as the ZyWALL's WAN MAC address. Refer to Chapter 7 on page 131 or Chapter 28 on page 429 . It is recommended that you clone your computer's MAC address, even if your ISP presently does not require MAC address authentication.
	If your ISP requires host name authentication, configure your computer's name as the ZyWALL's system name. Refer to Chapter 3 on page 75 or Chapter 27 on page 423 .

45.5 Problems Accessing the ZyWALL

Table 218 Troubleshooting Accessing the ZyWALL

PROBLEM	CORRECTIVE ACTION
Cannot access the ZyWALL.	The default password is "1234". The password field is case sensitive. Make sure that you enter the correct password using the proper casing.
	Use the Reset button to restore the factory default configuration file. This will restore all of the factory defaults including the password. See Section 2.3 on page 60 in Chapter 2 on page 59 for details.
Cannot access the ZyWALL via the console port.	<ol style="list-style-type: none"> 1. Check to see if the ZyWALL is connected to your computer's console port. 2. Check to see if the communications program is configured correctly. The communications software should be configured as follows: <ul style="list-style-type: none"> • VT100 terminal emulation. • 9600 bps is the default speed on leaving the factory. Try other speeds in case the speed has been changed. • No parity, 8 data bits, 1 stop bit, data flow set to none.

Table 218 Troubleshooting Accessing the ZyWALL

PROBLEM	CORRECTIVE ACTION
Cannot access the web configurator.	<p>Make sure that there is not an SMT console session running.</p> <p>Use the ZyWALL's WAN IP address when configuring from the WAN. Refer to the instructions on checking your WAN connection.</p> <p>Use the ZyWALL's LAN IP address when configuring from the LAN. Refer to for instructions on checking your LAN connection.</p> <p>Check that you have enabled web service access. If you have configured a secured client IP address, your computer's IP address must match it. Refer to the chapter on remote management for details.</p> <p>Your computer's and the ZyWALL's IP addresses must be on the same subnet for LAN access.</p> <p>If you changed the ZyWALL's LAN IP address, then enter the new one as the URL.</p> <p>Remove any filters in SMT menu 3.1 (LAN) or menu 11.5 (WAN) that block web service.</p> <p>See the following section to check that pop-up windows, JavaScripts and Java permissions are allowed.</p>
	<p>You may also need to clear your Internet browser's cache.</p> <p>In Internet Explorer, click Tools and then Internet Options to open the Internet Options screen.</p> <p>In the General tab, click Delete Files. In the pop-up window, select the Delete all offline content check box and click OK. Click OK in the Internet Options screen to close it.</p>
	<p>If you disconnect your computer from one device and connect it to another device that has the same IP address, your computer's ARP (Address Resolution Protocol) table may contain an entry that maps the management IP address to the previous device's MAC address).</p> <p>In Windows, use arp -d at the command prompt to delete all entries in your computer's ARP table.</p>

45.5.1 Pop-up Windows, JavaScripts and Java Permissions

In order to use the web configurator you need to allow:

- Web browser pop-up windows from your device.
- JavaScripts (enabled by default).
- Java permissions (enabled by default).

Note: Internet Explorer 6 screens are used here. Screens for other Internet Explorer versions may vary.

45.5.1.1 Internet Explorer Pop-up Blockers

You may have to disable pop-up blocking to log into your device.

Either disable pop-up blocking (enabled by default in Windows XP SP (Service Pack) 2) or allow pop-up blocking and create an exception for your device's IP address.

45.5.1.1.1 Disable pop-up Blockers

- 1 In Internet Explorer, select **Tools, Pop-up Blocker** and then select **Turn Off Pop-up Blocker**.

Figure 353 Pop-up Blocker

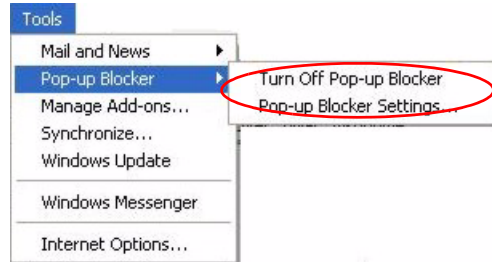

You can also check if pop-up blocking is disabled in the **Pop-up Blocker** section in the **Privacy** tab.

- 1 In Internet Explorer, select **Tools, Internet Options, Privacy**.
- 2 Clear the **Block pop-ups** check box in the **Pop-up Blocker** section of the screen. This disables any web pop-up blockers you may have enabled.

Figure 354 Internet Options

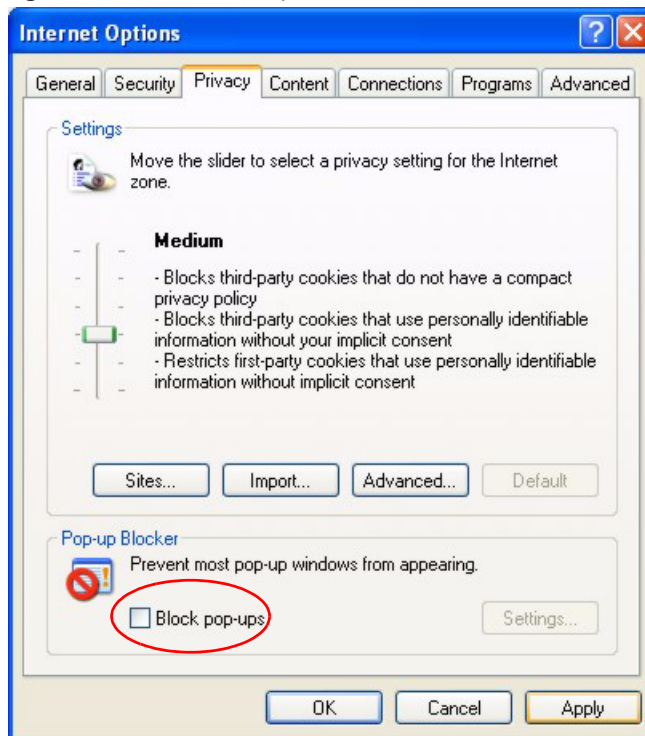

- 3 Click **Apply** to save this setting.

45.5.1.1.2 Enable pop-up Blockers with Exceptions

Alternatively, if you only want to allow pop-up windows from your device, see the following steps.

- 1 In Internet Explorer, select **Tools, Internet Options** and then the **Privacy** tab.
- 2 Select **Settings...** to open the **Pop-up Blocker Settings** screen.

Figure 355 Internet Options

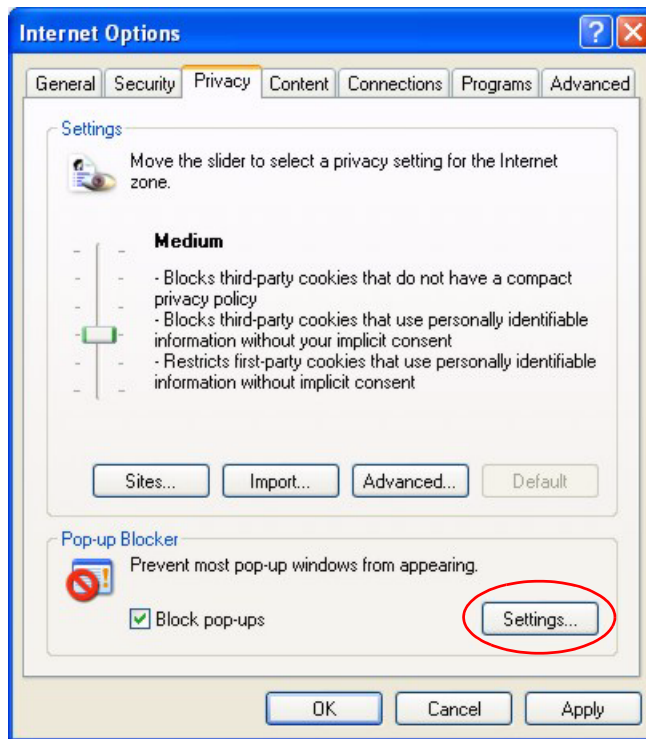

- 3 Type the IP address of your device (the web page that you do not want to have blocked) with the prefix "http://". For example, http://192.168.1.1.
- 4 Click **Add** to move the IP address to the list of **Allowed sites**.

Figure 356 Pop-up Blocker Settings

5 Click **Close** to return to the **Privacy** screen.

6 Click **Apply** to save this setting.

45.5.1.2 JavaScripts

If pages of the web configurator do not display properly in Internet Explorer, check that JavaScripts are allowed.

1 In Internet Explorer, click **Tools, Internet Options** and then the **Security** tab.

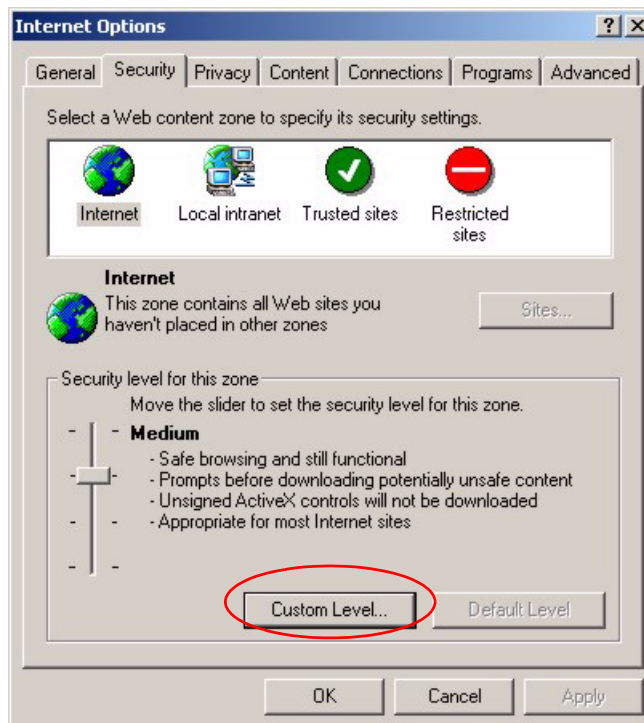
Figure 357 Internet Options

- 2** Click the **Custom Level...** button.
- 3** Scroll down to **Scripting**.
- 4** Under **Active scripting** make sure that **Enable** is selected (the default).
- 5** Under **Scripting of Java applets** make sure that **Enable** is selected (the default).
- 6** Click **OK** to close the window.

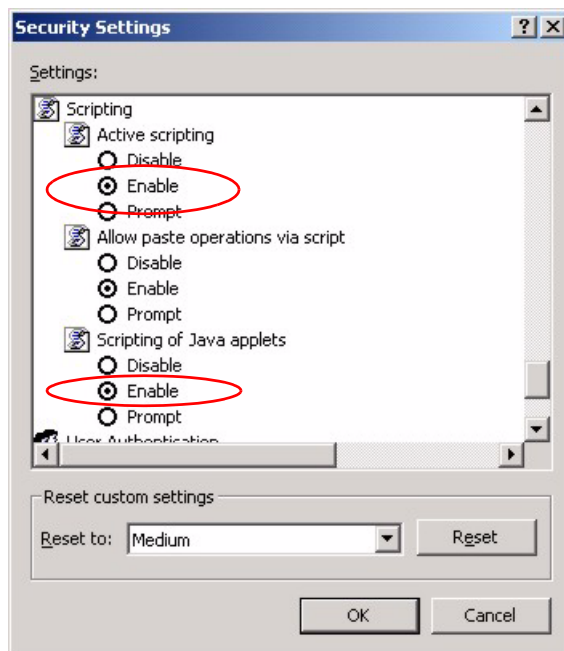
Figure 358 Security Settings - Java Scripting

45.5.1.3 Java Permissions

- 1 From Internet Explorer, click **Tools, Internet Options** and then the **Security** tab.
- 2 Click the **Custom Level...** button.
- 3 Scroll down to **Microsoft VM**.
- 4 Under **Java permissions** make sure that a safety level is selected.
- 5 Click **OK** to close the window.

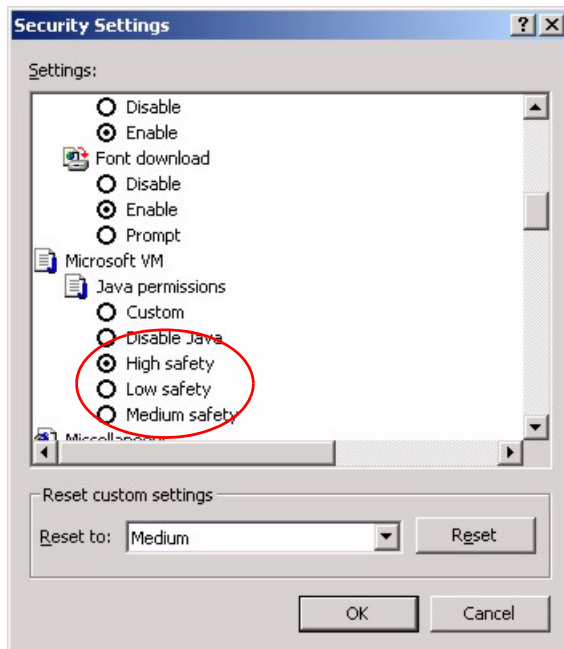
Figure 359 Security Settings - Java

45.5.1.3.1 JAVA (Sun)

- 1 From Internet Explorer, click **Tools, Internet Options** and then the **Advanced** tab.
- 2 make sure that **Use Java 2 for <applet>** under **Java (Sun)** is selected.
- 3 Click **OK** to close the window.

Figure 360 Java (Sun)

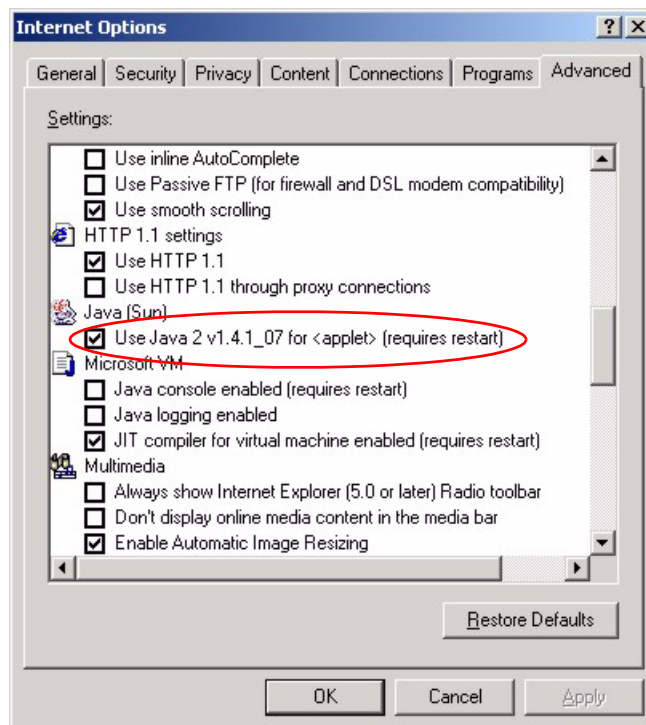

Appendix A

Product Specifications

See also the Introduction chapter for a general overview of the key features.

Specification Tables

Table 219 Device Specifications

Default IP Address	192.168.1.1
Default Subnet Mask	255.255.255.0 (24 bits)
Default Password	1234
DHCP Pool	192.168.1.33 to 192.168.1.160
Dimensions	355(L) x 200(D) x 55(H) mm
Weight	2,600g
Power Specification	100 ~ 240 VAC
Fuse Specifications	T 0.5 Amp, 250 VAC
LAN	Auto-negotiating, auto MDI/MDI-X 10/100 Mbps RJ-45 Ethernet port
WAN1 & WAN2	Auto-negotiating, auto MDI/MDI-X 10/100 Mbps RJ-45 Ethernet ports
4-port DMZ	4 Auto-negotiating, auto MDI/MDI-X 10/100 Mbps RJ-45 Ethernet ports
Reset Button	Restores factory default settings
Console	RS-232 DB9F
Dial Backup	RS-232 DB9M
Extension Card Slot	For installing an optional ZyXEL wireless LAN card
Operation Temperature	0° C ~ 50° C
Storage Temperature	-30° C ~ 60° C
Operation Humidity	20% ~ 95% RH (non-condensing)
Storage Humidity	20% ~ 95% RH (non-condensing)
Certifications	EMC: FCC Class B, CE-EMC Class B, C-Tick Class B, VCCI Class B Safety: CSA International, CE EN60950-1
MTBF (Bellcore model)	40.9 years (Mean Time Between Failures)

Table 220 Performance

Firewall Throughput	100Mbps
VPN 3DES/AES Throughput	50Mbps

Table 220 Performance (continued)

User Licenses	Unlimited
Concurrent Sessions	10,000
Simultaneous IPSec VPN Connections	100

Table 221 Firmware Features

Modes of Operation	Routing/NAT/SUA Mode Transparent Mode
Firewall (ICSA Certified)	IP Protocol/Packet Filter DoS and DDoS protections Stateful Packet Inspection Real time E-mail alerts Reports and logs Transparent Firewall
VPN (ICSA Certified)	Manual key, IKE PKI (X.509) Encryption (DES, 3DES and AES) Authentication (SHA-1 and MD5) IPSec NAT Traversal Xauth User Authentication (Internal Database and External RADIUS) DH1/2, RSA signature
Content Filtering	Web page blocking by URL keyword IKE + PKI support External database content filtering Java/ActiveX /Cookie/News blocking
Traffic Management	Guaranteed/Maximum Bandwidth Policy-based Traffic shaping Priority-bandwidth utilization Static Routes
High Availability (HA)	Auto fail-over, fall-back Dial Backup Dual WAN ports for WAN backup and Load Balancing
System Management	Embedded Web Configurator (HTTP and HTTPS) Menu-driven SMT (System Management Terminal) management CLI (Command Line Interpreter) Remote Management via Telnet or Web SNMP manageable Firmware Upgrade (web configurator, TFTP/FTP/SFTP) Vantage CNM

Table 221 Firmware Features (continued)

Wireless	<p>IEEE 802.11b Compliant IEEE 802.11g Compliant Frequency Range: 2.4 GHz Advanced Orthogonal Frequency Division Multiplexing (OFDM) IEEE 802.1x Authentication (Internal Database and External RADIUS) Store up to 32 built-in user profiles using EAP-MD5 (Internal Database) External Radius server using EAP-MD5, TLS, TTLS Wired Equivalent Privacy (WEP) Data Encryption 64/128/256 bit MAC Address filters WPA, WPA-PSK</p>
Logging/Monitoring	<p>Centralized Logs Attack alert System status monitoring Syslog</p>
Other Protocol Support	<p>PPP (Point-to-Point Protocol) link layer protocol. Transparent bridging for unsupported network layer protocols. DHCP Server/Client/Relay RIP I/RIP II ICMP SNMP v1 and v2c with MIB II support (RFC 1213) IP Multicasting IGMP v1 and v2 IGMP Proxy UPnP</p>
Other Features	<p>Transparent Firewall (Bridge mode) Load Balancing Dynamic DNS IP Alias Static Routes IP Policy Routing Bandwidth Management</p>

Table 222 Feature Specifications

FEATURE	SPECIFICATION
Number of Static DHCP Table Entries	128
Number of Static Routes	50
Number of Policy Routes	48
Number of Port Forwarding Rules	100
Number of NAT Sessions	10000
Number of Address Mapping Rules	100
Number of IPSec VPN Tunnels/Security Associations	100
Number of Bandwidth Management Classes	100
Number of Bandwidth Management Class Levels	5

Table 222 Feature Specifications (continued)

FEATURE	SPECIFICATION
Number of DNS Address Record Entries	8
Number of DNS Name Server Record Entries	16

Compatible ZyXEL WLAN Cards

The following table lists the ZyXEL WLAN cards that you can use in the ZyWALL at the time of writing. It also shows the security features that each card supports.

Note: Check the product page on the www.zyxel.com website for updates on ZyXEL WLAN cards that you can use in the ZyWALL.

Table 223 Compatible ZyXEL WLAN Cards and Security Features

	B-100	B-101	B-120	G-100	G-110
No Security	Yes	Yes	Yes	Yes	Yes
Static WEP	Yes	Yes	Yes	Yes	Yes
WPA-PSK	No	No	Yes	Yes	Yes
WPA (MD5 is not supported)	No	No	Yes	Yes	Yes
802.1x + Dynamic WEP (MD5 is not supported)	No	No	Yes	Yes	Yes
802.1x + Static WEP	Yes	Yes	Yes	Yes	Yes
802.1x + No WEP	Yes	Yes	Yes	Yes	Yes
No Access 802.1x + Static WEP	Yes	Yes	Yes	Yes	Yes
No Access 802.1x + No WEP	Yes	Yes	Yes	Yes	Yes

WLAN Card Installation

Note: Do not insert or remove a card with the ZyWALL turned on.

Make sure the ZyWALL is off before inserting or removing an 802.11b/g-compliant wireless LAN PCMCIA or CardBus card (to avoid damage). Slide the 64-pin connector end of the PCMCIA or CardBus wireless LAN card into the slot as shown next.

Note: Only certain ZyXEL wireless LAN cards are compatible with the ZyWALL.

Do not force, bend or twist the wireless LAN card.

Figure 361 WLAN Card Installation

Cable Pin Assignments

In a serial communications connection, generally a computer is DTE (Data Terminal Equipment) and a modem is DCE (Data Circuit-terminating Equipment). The ZyWALL is DCE when you connect a computer to the console port. The ZyWALL is DTE when you connect a modem to the dial backup port.²

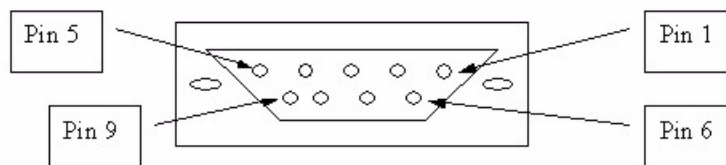
Figure 362 Console/Dial Backup Port Pin Layout

2. Pins 2,3 and 5 are used.

Table 224 Console/Dial Backup Port Pin Assignments

CONSOLE Port RS – 232 (Female) DB-9F	DIAL BACKUP RS – 232 (Male) DB-9M (Not on all models)
Pin 1 = NON Pin 2 = DCE-TXD Pin 3 = DCE –RXD Pin 4 = DCE –DSR Pin 5 = GND Pin 6 = DCE –DTR Pin 7 = DCE –CTS Pin 8 = DCE –RTS PIN 9 = NON	Pin 1 = NON Pin 2 = DTE-RXD Pin 3 = DTE-TXD Pin 4 = DTE-DTR Pin 5 = GND Pin 6 = DTE-DSR Pin 7 = DTE-RTS Pin 8 = DTE-CTS PIN 9 = NON.
The CON/AUX port also has these pin assignments. The CON/AUX switch changes the setting in the firmware only and does not change the CON/AUX port's pin assignments.	ZyWALLs with a CON/AUX port also have a 9-pin adaptor for the console cable with these pin assignments on the male end.

Figure 363 Ethernet Cable Pin Assignments

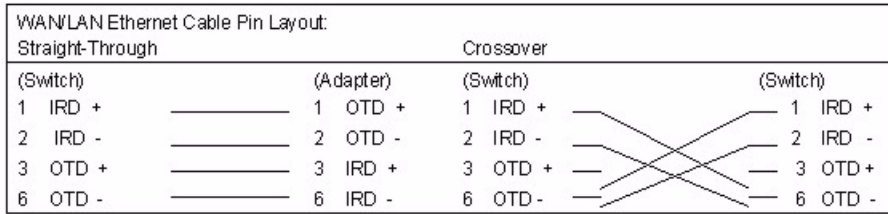

Appendix B

Removing and Installing a Fuse

This appendix shows you how to remove and install fuses for the ZyWALL.

If you need to install a new fuse, follow the procedure below.

Note: If you use a fuse other than the included fuses, make sure it matches the fuse specifications in the appendix on product specifications.

Removing a Fuse

Note: Disconnect all power from the ZyWALL before you begin this procedure.

- 1 Place the rear panel of the ZyWALL in front of you.
- 2 Remove the power cord from the back of the unit.
- 3 The fuse housing is located between the power switch and the power port. Use a small flat-head screwdriver to carefully pry out the fuse housing.
- 4 A burnt-out fuse is blackened, darkened or cloudy inside its glass casing. A working fuse has a completely clear glass casing. Pull gently, but firmly, to remove the burnt out fuse from the fuse housing. Dispose of the burnt-out fuse.

Installing a Fuse

- 1 The ZyWALL is shipped from the factory with one spare fuse included in a box-like section of the fuse housing. Push the middle part of the box-like section to access the spare fuse. Put another spare fuse in its place in order to always have one on hand.
- 2 Push the replacement fuse into the fuse housing until you hear a click.
- 3 Firmly, but gently, push the fuse housing back into the ZYWALL until you hear a click.
- 4 Plug the power cord back into the unit.

APPENDIX C

Setting up Your Computer's IP Address

All computers must have a 10M or 100M Ethernet adapter card and TCP/IP installed.

Windows 95/98/Me/NT/2000/XP, Macintosh OS 7 and later operating systems and all versions of UNIX/LINUX include the software components you need to install and use TCP/IP on your computer. Windows 3.1 requires the purchase of a third-party TCP/IP application package.

TCP/IP should already be installed on computers using Windows NT/2000/XP, Macintosh OS 7 and later operating systems.

After the appropriate TCP/IP components are installed, configure the TCP/IP settings in order to "communicate" with your network.

If you manually assign IP information instead of using dynamic assignment, make sure that your computers have IP addresses that place them in the same subnet as the ZyWALL's LAN port.

Windows 95/98/Me

Click **Start**, **Settings**, **Control Panel** and double-click the **Network** icon to open the **Network** window.

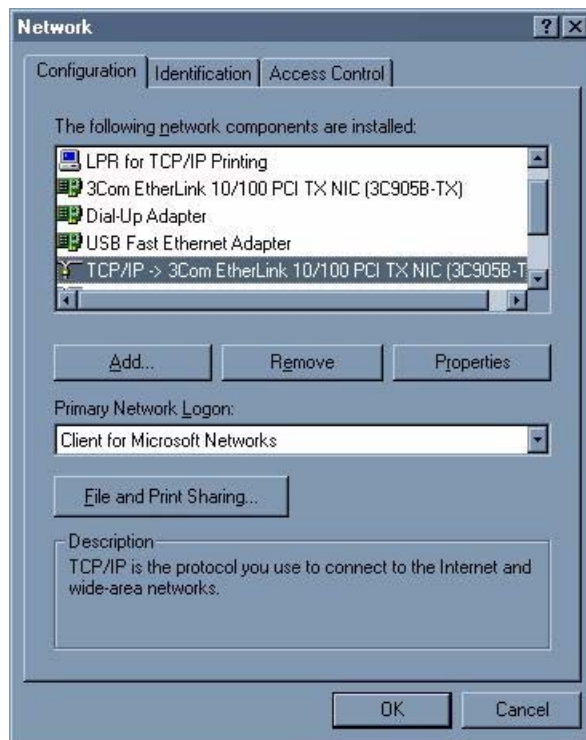
Figure 364 Windows 95/98/Me: Network: Configuration

Installing Components

The **Network** window **Configuration** tab displays a list of installed components. You need a network adapter, the TCP/IP protocol and Client for Microsoft Networks.

If you need the adapter:

- 1 In the **Network** window, click **Add**.
- 2 Select **Adapter** and then click **Add**.
- 3 Select the manufacturer and model of your network adapter and then click **OK**.

If you need TCP/IP:

- 1 In the **Network** window, click **Add**.
- 2 Select **Protocol** and then click **Add**.
- 3 Select **Microsoft** from the list of **manufacturers**.
- 4 Select **TCP/IP** from the list of network protocols and then click **OK**.

If you need Client for Microsoft Networks:

- 1 Click **Add**.
- 2 Select **Client** and then click **Add**.

- 3 Select **Microsoft** from the list of manufacturers.
- 4 Select **Client for Microsoft Networks** from the list of network clients and then click **OK**.
- 5 Restart your computer so the changes you made take effect.

Configuring

- 1 In the **Network** window **Configuration** tab, select your network adapter's TCP/IP entry and click **Properties**
- 2 Click the **IP Address** tab.
 - If your IP address is dynamic, select **Obtain an IP address automatically**.
 - If you have a static IP address, select **Specify an IP address** and type your information into the **IP Address** and **Subnet Mask** fields.

Figure 365 Windows 95/98/Me: TCP/IP Properties: IP Address

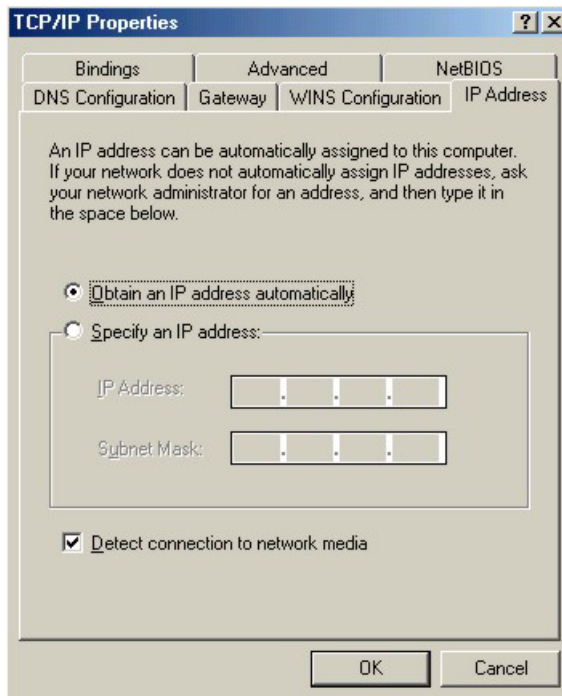

- 3 Click the **DNS Configuration** tab.
 - If you do not know your DNS information, select **Disable DNS**.
 - If you know your DNS information, select **Enable DNS** and type the information in the fields below (you may not need to fill them all in).

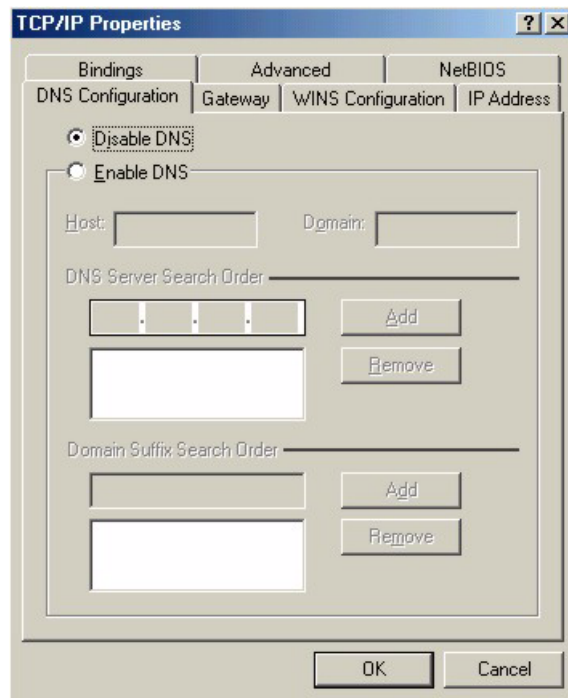
Figure 366 Windows 95/98/Me: TCP/IP Properties: DNS Configuration**4** Click the **Gateway** tab.

- If you do not know your gateway's IP address, remove previously installed gateways.
- If you have a gateway IP address, type it in the **New gateway field** and click **Add**.

5 Click **OK** to save and close the **TCP/IP Properties** window.**6** Click **OK** to close the **Network** window. Insert the Windows CD if prompted.**7** Turn on your ZyWALL and restart your computer when prompted.

Verifying Settings

1 Click **Start** and then **Run**.**2** In the **Run** window, type "winipcfg" and then click **OK** to open the **IP Configuration** window.**3** Select your network adapter. You should see your computer's IP address, subnet mask and default gateway.

Windows 2000/NT/XP

The following example figures use the default Windows XP GUI theme.

1 Click **start** (**Start** in Windows 2000/NT), **Settings, Control Panel**.

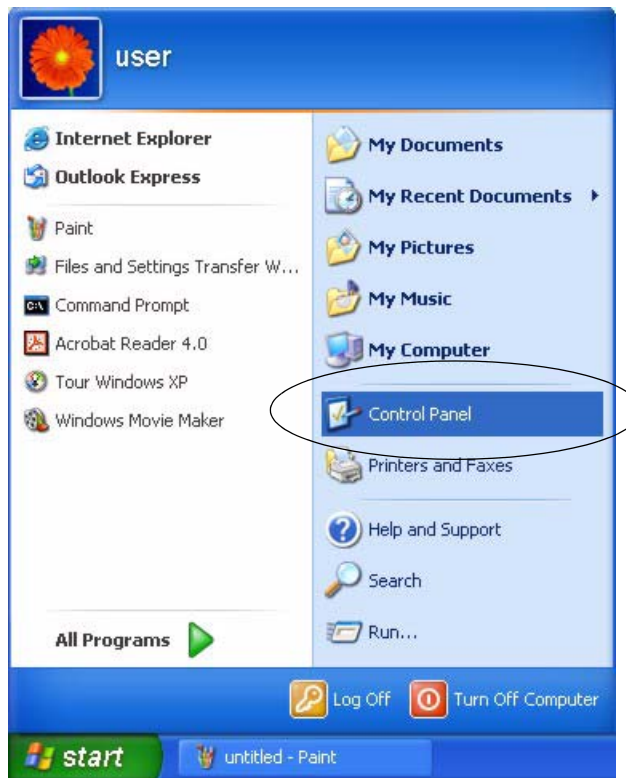
Figure 367 Windows XP: Start Menu

2 In the **Control Panel**, double-click **Network Connections (Network and Dial-up Connections)** in Windows 2000/NT).

Figure 368 Windows XP: Control Panel

3 Right-click **Local Area Connection** and then click **Properties**.

Figure 369 Windows XP: Control Panel: Network Connections: Properties

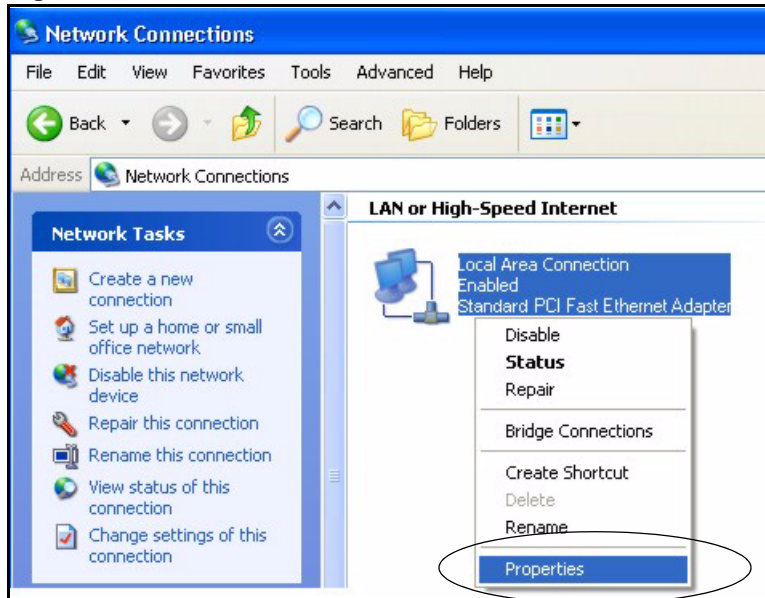

4 Select **Internet Protocol (TCP/IP)** (under the **General** tab in Win XP) and then click **Properties**.

Figure 370 Windows XP: Local Area Connection Properties

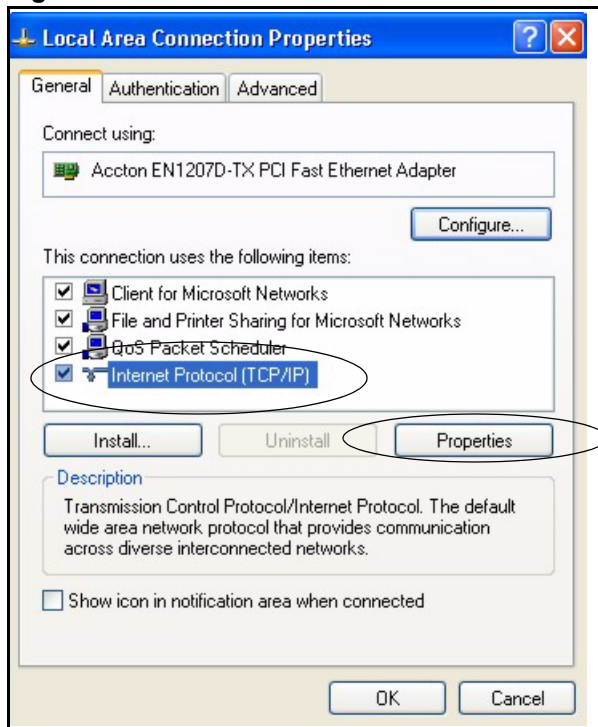

5 The **Internet Protocol TCP/IP Properties** window opens (the **General** tab in Windows XP).

- If you have a dynamic IP address click **Obtain an IP address automatically**.

- If you have a static IP address click **Use the following IP Address** and fill in the **IP address**, **Subnet mask**, and **Default gateway** fields.
- Click **Advanced**.

Figure 371 Windows XP: Internet Protocol (TCP/IP) Properties

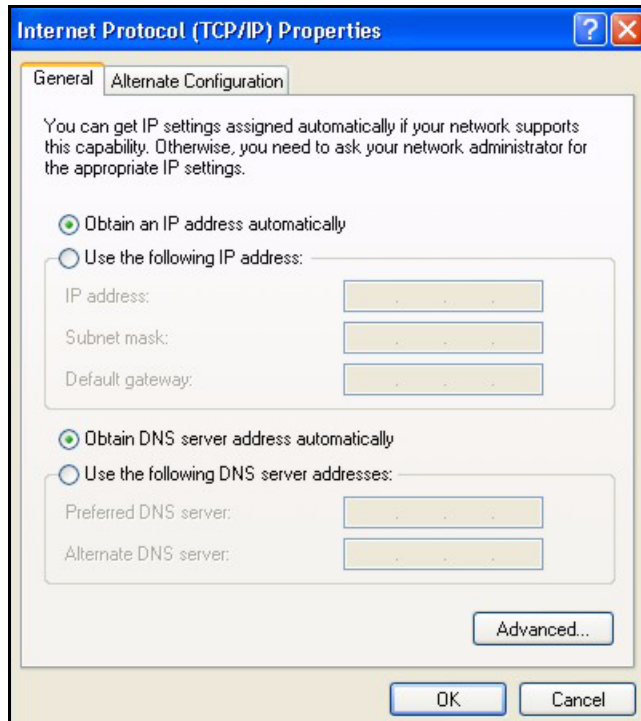

- 6** If you do not know your gateway's IP address, remove any previously installed gateways in the **IP Settings** tab and click **OK**.

Do one or more of the following if you want to configure additional IP addresses:

- In the **IP Settings** tab, in IP addresses, click **Add**.
- In **TCP/IP Address**, type an IP address in **IP address** and a subnet mask in **Subnet mask**, and then click **Add**.
- Repeat the above two steps for each IP address you want to add.
- Configure additional default gateways in the **IP Settings** tab by clicking **Add** in **Default gateways**.
- In **TCP/IP Gateway Address**, type the IP address of the default gateway in **Gateway**. To manually configure a default metric (the number of transmission hops), clear the **Automatic metric** check box and type a metric in **Metric**.
- Click **Add**.
- Repeat the previous three steps for each default gateway you want to add.
- Click **OK** when finished.

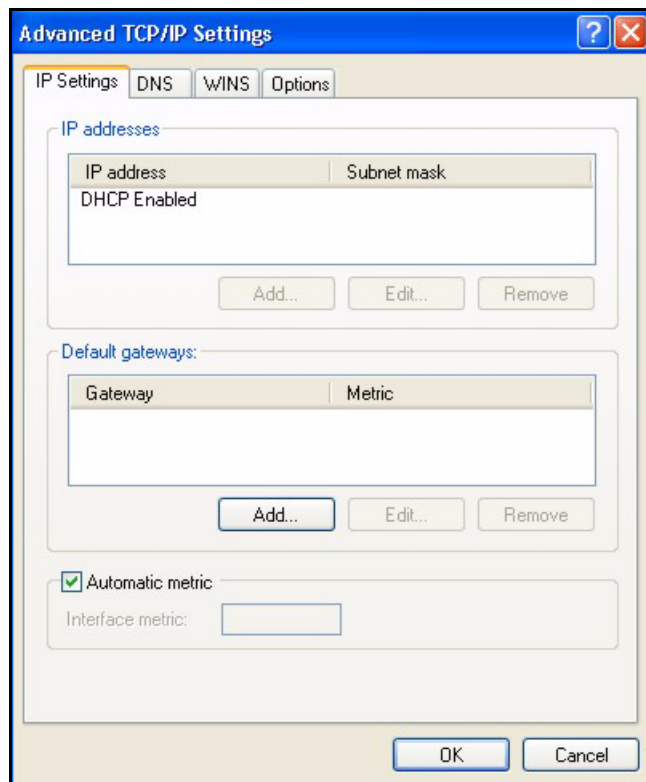
Figure 372 Windows XP: Advanced TCP/IP Properties

7 In the **Internet Protocol TCP/IP Properties** window (the **General** tab in Windows XP):

- Click **Obtain DNS server address automatically** if you do not know your DNS server IP address(es).
- If you know your DNS server IP address(es), click **Use the following DNS server addresses**, and type them in the **Preferred DNS server** and **Alternate DNS server** fields.

If you have previously configured DNS servers, click **Advanced** and then the **DNS** tab to order them.

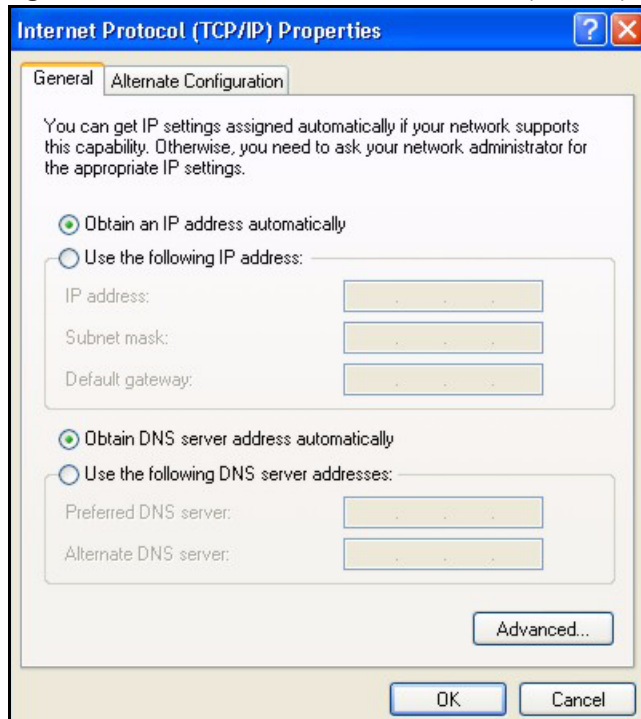
Figure 373 Windows XP: Internet Protocol (TCP/IP) Properties

- 8** Click **OK** to close the **Internet Protocol (TCP/IP) Properties** window.
- 9** Click **Close (OK in Windows 2000/NT)** to close the **Local Area Connection Properties** window.
- 10** Close the **Network Connections** window (**Network and Dial-up Connections** in Windows 2000/NT).
- 11** Turn on your ZyWALL and restart your computer (if prompted).

Verifying Settings

- 1** Click **Start, All Programs, Accessories** and then **Command Prompt**.
- 2** In the **Command Prompt** window, type "ipconfig" and then press [ENTER]. You can also open **Network Connections**, right-click a network connection, click **Status** and then click the **Support** tab.

Macintosh OS 8/9

- 1** Click the **Apple** menu, **Control Panel** and double-click **TCP/IP** to open the **TCP/IP Control Panel**.

Figure 374 Macintosh OS 8/9: Apple Menu

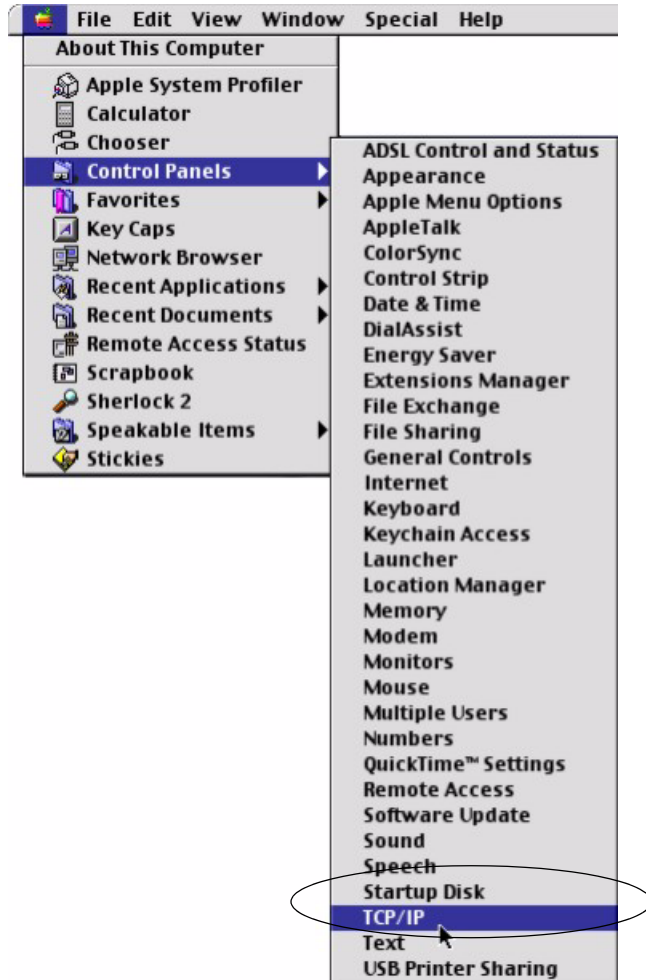

2 Select **Ethernet built-in** from the **Connect via** list.

Figure 375 Macintosh OS 8/9: TCP/IP

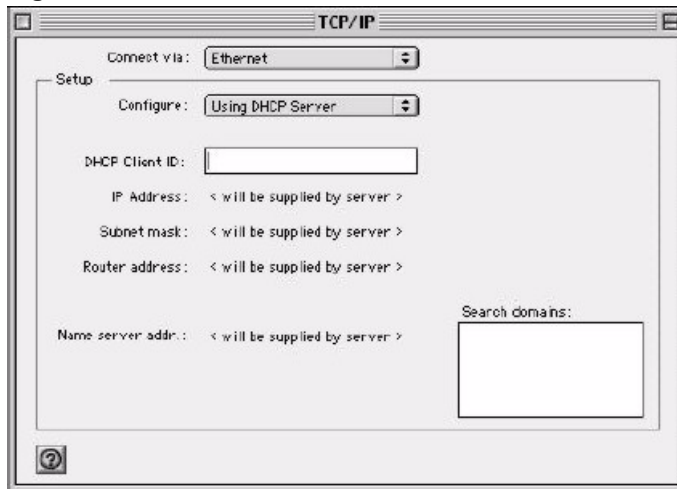

3 For dynamically assigned settings, select **Using DHCP Server** from the **Configure:** list.

- 4 For statically assigned settings, do the following:
 - From the **Configure** box, select **Manually**.
 - Type your IP address in the **IP Address** box.
 - Type your subnet mask in the **Subnet mask** box.
 - Type the IP address of your ZyWALL in the **Router address** box.
- 5 Close the **TCP/IP Control Panel**.
- 6 Click **Save** if prompted, to save changes to your configuration.
- 7 Turn on your ZyWALL and restart your computer (if prompted).

Verifying Settings

Check your TCP/IP properties in the **TCP/IP Control Panel** window.

Macintosh OS X

- 1 Click the **Apple** menu, and click **System Preferences** to open the **System Preferences** window.

Figure 376 Macintosh OS X: Apple Menu

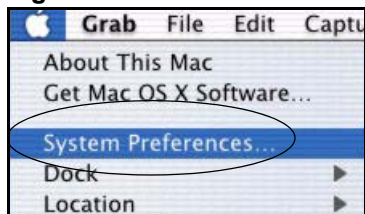

- 2 Click **Network** in the icon bar.
 - Select **Automatic** from the **Location** list.
 - Select **Built-in Ethernet** from the **Show** list.
 - Click the **TCP/IP** tab.
- 3 For dynamically assigned settings, select **Using DHCP** from the **Configure** list.

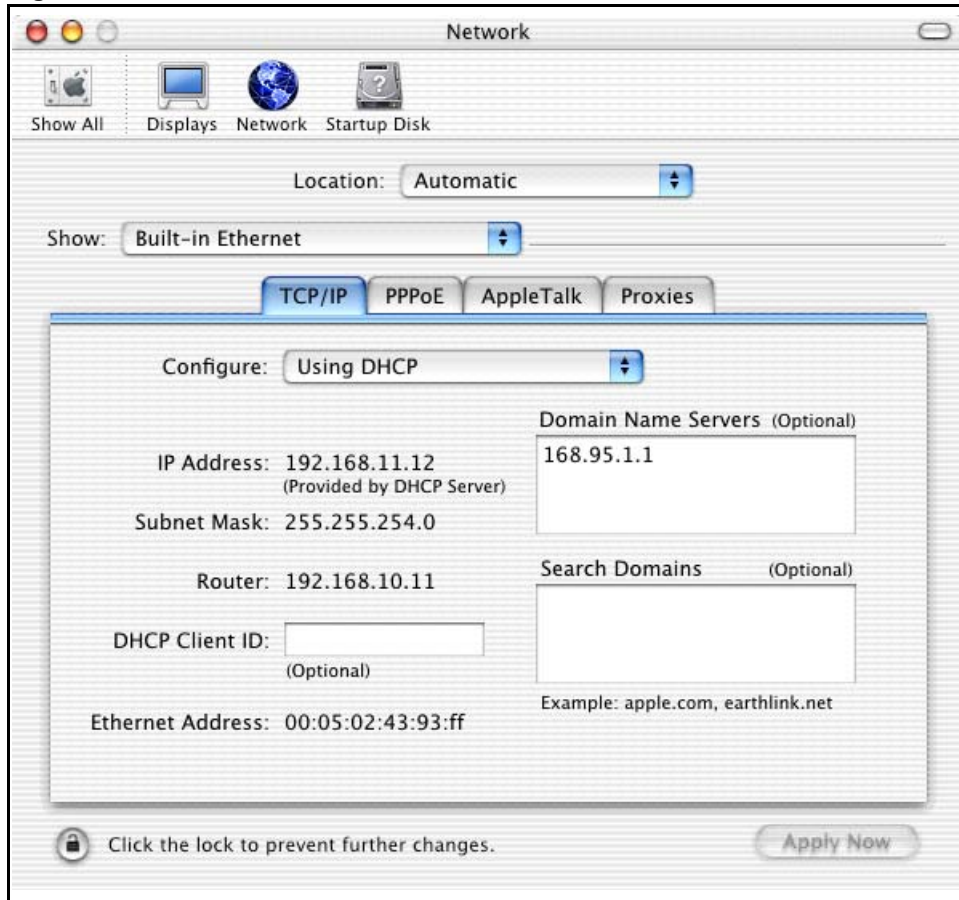
Figure 377 Macintosh OS X: Network

4 For statically assigned settings, do the following:

- From the **Configure** box, select **Manually**.
- Type your IP address in the **IP Address** box.
- Type your subnet mask in the **Subnet mask** box.
- Type the IP address of your ZyWALL in the **Router address** box.

5 Click **Apply Now** and close the window.

6 Turn on your ZyWALL and restart your computer (if prompted).

Verifying Settings

Check your TCP/IP properties in the **Network** window.

APPENDIX D

IP Subnetting

IP Addressing

Routers “route” based on the network number. The router that delivers the data packet to the correct destination host uses the host ID.

IP Classes

An IP address is made up of four octets (eight bits), written in dotted decimal notation, for example, 192.168.1.1. IP addresses are categorized into different classes. The class of an address depends on the value of its first octet.

- Class “A” addresses have a 0 in the left most bit. In a class “A” address the first octet is the network number and the remaining three octets make up the host ID.
- Class “B” addresses have a 1 in the left most bit and a 0 in the next left most bit. In a class “B” address the first two octets make up the network number and the two remaining octets make up the host ID.
- Class “C” addresses begin (starting from the left) with 1 1 0. In a class “C” address the first three octets make up the network number and the last octet is the host ID.
- Class “D” addresses begin with 1 1 1 0. Class “D” addresses are used for multicasting. (There is also a class “E” address. It is reserved for future use.)

Table 225 Classes of IP Addresses

IP ADDRESS:		OCTET 1	OCTET 2	OCTET 3	OCTET 4
Class A	0	Network number	Host ID	Host ID	Host ID
Class B	10	Network number	Network number	Host ID	Host ID
Class C	110	Network number	Network number	Network number	Host ID

Note: Host IDs of all zeros or all ones are not allowed.

Therefore:

A class “C” network (8 host bits) can have $2^8 - 2$ or 254 hosts.

A class “B” address (16 host bits) can have $2^{16} - 2$ or 65534 hosts.

A class “A” address (24 host bits) can have $2^{24} - 2$ hosts (approximately 16 million hosts).

Since the first octet of a class “A” IP address must contain a “0”, the first octet of a class “A” address can have a value of 0 to 127.

Similarly the first octet of a class “B” must begin with “10”, therefore the first octet of a class “B” address has a valid range of 128 to 191. The first octet of a class “C” address begins with “110”, and therefore has a range of 192 to 223.

Table 226 Allowed IP Address Range By Class

CLASS	ALLOWED RANGE OF FIRST OCTET (BINARY)	ALLOWED RANGE OF FIRST OCTET (DECIMAL)
Class A	00000000 to 01111111	0 to 127
Class B	10000000 to 10111111	128 to 191
Class C	11000000 to 11011111	192 to 223
Class D	11100000 to 11101111	224 to 239

Subnet Masks

A subnet mask is used to determine which bits are part of the network number, and which bits are part of the host ID (using a logical AND operation). A subnet mask has 32 is a “1” then the corresponding bit in the IP address is part of the network number. If a bit in the subnet mask is “0” then the corresponding bit in the IP address is part of the host ID.

Subnet masks are expressed in dotted decimal notation just as IP addresses are. The “natural” masks for class A, B and C IP addresses are as follows.

Table 227 “Natural” Masks

CLASS	NATURAL MASK
A	255.0.0.0
B	255.255.0.0
C	255.255.255.0

Subnetting

With subnetting, the class arrangement of an IP address is ignored. For example, a class C address no longer has to have 24 bits of network number and 8 bits of host ID. With subnetting, some of the host ID bits are converted into network number bits. By convention, subnet masks always consist of a continuous sequence of ones beginning from the left most bit of the mask, followed by a continuous sequence of zeros, for a total number of 32 bits.

Since the mask is always a continuous number of ones beginning from the left, followed by a continuous number of zeros for the remainder of the 32 bit mask, you can simply specify the number of ones instead of writing the value of each octet. This is usually specified by writing a “/” followed by the number of bits in the mask after the address.

For example, 192.1.1.0 /25 is equivalent to saying 192.1.1.0 with mask 255.255.255.128.

The following table shows all possible subnet masks for a class “C” address using both notations.

Table 228 Alternative Subnet Mask Notation

SUBNET MASK IP ADDRESS	SUBNET MASK “1” BITS	LAST OCTET BIT VALUE
255.255.255.0	/24	0000 0000
255.255.255.128	/25	1000 0000
255.255.255.192	/26	1100 0000
255.255.255.224	/27	1110 0000
255.255.255.240	/28	1111 0000
255.255.255.248	/29	1111 1000
255.255.255.252	/30	1111 1100

The first mask shown is the class “C” natural mask. Normally if no mask is specified it is understood that the natural mask is being used.

Example: Two Subnets

As an example, you have a class “C” address 192.168.1.0 with subnet mask of 255.255.255.0.

Table 229 Two Subnets Example

	NETWORK NUMBER	HOST ID
IP Address	192.168.1.	0
IP Address (Binary)	11000000.10101000.00000001.	00000000
Subnet Mask	255.255.255.	0
Subnet Mask (Binary)	11111111.11111111.11111111.	00000000

The first three octets of the address make up the network number (class “C”). You want to have two separate networks.

Divide the network 192.168.1.0 into two separate subnets by converting one of the host ID bits of the IP address to a network number bit. The “borrowed” host ID bit can be either “0” or “1” thus giving two subnets; 192.168.1.0 with mask 255.255.255.128 and 192.168.1.128 with mask 255.255.255.128.

Note: In the following charts, shaded/bolded last octet bit values indicate host ID bits “borrowed” to form network ID bits. The number of “borrowed” host ID bits determines the number of subnets you can have. The remaining number of host ID bits (after “borrowing”) determines the number of hosts you can have on each subnet.

Table 230 Subnet 1

	NETWORK NUMBER	LAST OCTET BIT VALUE
IP Address	192.168.1.	0
IP Address (Binary)	11000000.10101000.00000001.	00000000
Subnet Mask	255.255.255.	128
Subnet Mask (Binary)	11111111.11111111.11111111.	10000000
Subnet Address: 192.168.1.0	Lowest Host ID: 192.168.1.1	
Broadcast Address: 192.168.1.127	Highest Host ID: 192.168.1.126	

Table 231 Subnet 2

	NETWORK NUMBER	LAST OCTET BIT VALUE
IP Address	192.168.1.	128
IP Address (Binary)	11000000.10101000.00000001.	10000000
Subnet Mask	255.255.255.	128
Subnet Mask (Binary)	11111111.11111111.11111111.	10000000
Subnet Address: 192.168.1.128	Lowest Host ID: 192.168.1.129	
Broadcast Address: 192.168.1.255	Highest Host ID: 192.168.1.254	

The remaining 7 bits determine the number of hosts each subnet can have. Host IDs of all zeros represent the subnet itself and host IDs of all ones are the broadcast address for that subnet, so the actual number of hosts available on each subnet in the example above is $2^7 - 2$ or 126 hosts for each subnet.

192.168.1.0 with mask 255.255.255.128 is the subnet itself, and 192.168.1.127 with mask 255.255.255.128 is the directed broadcast address for the first subnet. Therefore, the lowest IP address that can be assigned to an actual host for the first subnet is 192.168.1.1 and the highest is 192.168.1.126. Similarly the host ID range for the second subnet is 192.168.1.129 to 192.168.1.254.

Example: Four Subnets

The above example illustrated using a 25-bit subnet mask to divide a class “C” address space into two subnets. Similarly to divide a class “C” address into four subnets, you need to “borrow” two host ID bits to give four possible combinations of 00, 01, 10 and 11. The subnet mask is 26 bits (11111111.11111111.11111111.11000000) or 255.255.255.192. Each subnet contains 6 host ID bits, giving 2^6-2 or 62 hosts for each subnet (all 0's is the subnet itself, all 1's is the broadcast address on the subnet).

Table 232 Subnet 1

	NETWORK NUMBER	LAST OCTET BIT VALUE
IP Address	192.168.1.	0
IP Address (Binary)	11000000.10101000.00000001.	00000000
Subnet Mask (Binary)	11111111.11111111.11111111.	11000000
Subnet Address: 192.168.1.0	Lowest Host ID: 192.168.1.1	
Broadcast Address: 192.168.1.63	Highest Host ID: 192.168.1.62	

Table 233 Subnet 2

	NETWORK NUMBER	LAST OCTET BIT VALUE
IP Address	192.168.1.	64
IP Address (Binary)	11000000.10101000.00000001.	01000000
Subnet Mask (Binary)	11111111.11111111.11111111.	11000000
Subnet Address: 192.168.1.64	Lowest Host ID: 192.168.1.65	
Broadcast Address: 192.168.1.127	Highest Host ID: 192.168.1.126	

Table 234 Subnet 3

	NETWORK NUMBER	LAST OCTET BIT VALUE
IP Address	192.168.1.	128
IP Address (Binary)	11000000.10101000.00000001.	10000000
Subnet Mask (Binary)	11111111.11111111.11111111.	11000000
Subnet Address: 192.168.1.128	Lowest Host ID: 192.168.1.129	
Broadcast Address: 192.168.1.191	Highest Host ID: 192.168.1.190	

Table 235 Subnet 4

	NETWORK NUMBER	LAST OCTET BIT VALUE
IP Address	192.168.1.	192
IP Address (Binary)	11000000.10101000.00000001.	11000000
Subnet Mask (Binary)	11111111.11111111.11111111.	11000000
Subnet Address: 192.168.1.192	Lowest Host ID: 192.168.1.193	
Broadcast Address: 192.168.1.255	Highest Host ID: 192.168.1.254	

Example Eight Subnets

Similarly use a 27-bit mask to create 8 subnets (001, 010, 011, 100, 101, 110).

The following table shows class C IP address last octet values for each subnet.

Table 236 Eight Subnets

SUBNET	SUBNET ADDRESS	FIRST ADDRESS	LAST ADDRESS	BROADCAST ADDRESS
1	0	1	30	31
2	32	33	62	63
3	64	65	94	95
4	96	97	126	127
5	128	129	158	159
6	160	161	190	191
7	192	193	222	223
8	224	225	254	255

The following table is a summary for class “C” subnet planning.

Table 237 Class C Subnet Planning

NO. “BORROWED” HOST BITS	SUBNET MASK	NO. SUBNETS	NO. HOSTS PER SUBNET
1	255.255.255.128 (/25)	2	126
2	255.255.255.192 (/26)	4	62
3	255.255.255.224 (/27)	8	30
4	255.255.255.240 (/28)	16	14
5	255.255.255.248 (/29)	32	6
6	255.255.255.252 (/30)	64	2
7	255.255.255.254 (/31)	128	1

Subnetting With Class A and Class B Networks.

For class “A” and class “B” addresses the subnet mask also determines which bits are part of the network number and which are part of the host ID.

A class “B” address has two host ID octets available for subnetting and a class “A” address has three host ID octets (see [Table 225 on page 595](#)) available for subnetting.

The following table is a summary for class “B” subnet planning.

Table 238 Class B Subnet Planning

NO. “BORROWED” HOST BITS	SUBNET MASK	NO. SUBNETS	NO. HOSTS PER SUBNET
1	255.255.128.0 (/17)	2	32766
2	255.255.192.0 (/18)	4	16382
3	255.255.224.0 (/19)	8	8190
4	255.255.240.0 (/20)	16	4094
5	255.255.248.0 (/21)	32	2046
6	255.255.252.0 (/22)	64	1022
7	255.255.254.0 (/23)	128	510
8	255.255.255.0 (/24)	256	254
9	255.255.255.128 (/25)	512	126
10	255.255.255.192 (/26)	1024	62
11	255.255.255.224 (/27)	2048	30
12	255.255.255.240 (/28)	4096	14
13	255.255.255.248 (/29)	8192	6
14	255.255.255.252 (/30)	16384	2
15	255.255.255.254 (/31)	32768	1

APPENDIX E

PPPoE

PPPoE in Action

An ADSL modem bridges a PPP session over Ethernet (PPP over Ethernet, RFC 2516) from your computer to an ATM PVC (Permanent Virtual Circuit) which connects to a DSL Access Concentrator where the PPP session terminates (see [Figure 378 on page 604](#)). One PVC can support any number of PPP sessions from your LAN. PPPoE provides access control and billing functionality in a manner similar to dial-up services using PPP.

Benefits of PPPoE

PPPoE offers the following benefits:

It provides you with a familiar dial-up networking (DUN) user interface.

It lessens the burden on the carriers of provisioning virtual circuits all the way to the ISP on multiple switches for thousands of users. For GSTN (PSTN and ISDN), the switching fabric is already in place.

It allows the ISP to use the existing dial-up model to authenticate and (optionally) to provide differentiated services.

Traditional Dial-up Scenario

The following diagram depicts a typical hardware configuration where the computers use traditional dial-up networking.

Figure 378 Single-Computer per Router Hardware Configuration

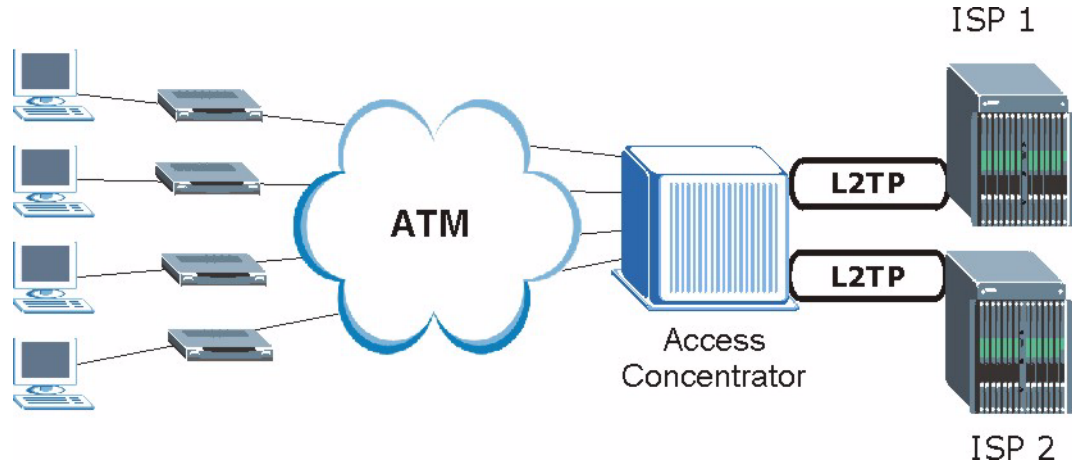

How PPPoE Works

The PPPoE driver makes the Ethernet appear as a serial link to the computer and the computer runs PPP over it, while the modem bridges the Ethernet frames to the Access Concentrator (AC). Between the AC and an ISP, the AC is acting as a L2TP (Layer 2 Tunneling Protocol) LAC (L2TP Access Concentrator) and tunnels the PPP frames to the ISP. The L2TP tunnel is capable of carrying multiple PPP sessions.

With PPPoE, the VC (Virtual Circuit) is equivalent to the dial-up connection and is between the modem and the AC, as opposed to all the way to the ISP. However, the PPP negotiation is between the computer and the ISP.

ZyWALL as a PPPoE Client

When using the ZyWALL as a PPPoE client, the computers on the LAN see only Ethernet and are not aware of PPPoE. This alleviates the administrator from having to manage the PPPoE clients on the individual computers.

Figure 379 ZyWALL as a PPPoE Client

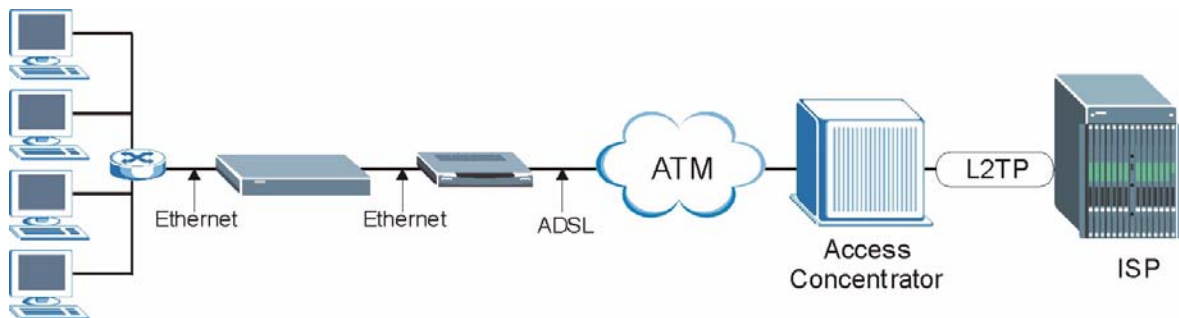

APPENDIX F

PPTP

What is PPTP?

PPTP (Point-to-Point Tunneling Protocol) is a Microsoft proprietary protocol (RFC 2637 for PPTP is informational only) to tunnel PPP frames.

How can we transport PPP frames from a computer to a broadband modem over Ethernet?

A solution is to build PPTP into the ANT (ADSL Network Termination) where PPTP is used only over the short haul between the computer and the modem over Ethernet. For the rest of the connection, the PPP frames are transported with PPP over AAL5 (RFC 2364). The PPP connection, however, is still between the computer and the ISP. The various connections in this setup are depicted in the following diagram. The drawback of this solution is that it requires one separate ATM VC per destination.

Figure 380 Transport PPP frames over Ethernet

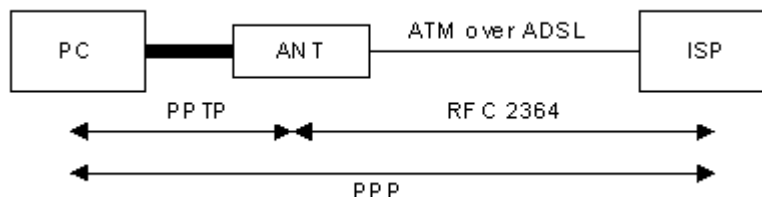

PPTP and the ZyWALL

When the ZyWALL is deployed in such a setup, it appears as a computer to the ANT.

In Windows VPN or PPTP Pass-Through feature, the PPTP tunneling is created from Windows 95, 98 and NT clients to an NT server in a remote location. The pass-through feature allows users on the network to access a different remote server using the ZyWALL's Internet connection. In SUA/NAT mode, the ZyWALL is able to pass the PPTP packets to the internal PPTP server (i.e. NT server) behind the NAT. You need to configure port forwarding for port 1723 to have the ZyWALL forward PPTP packets to the server. In the case above as the remote PPTP Client initializes the PPTP connection, the user must configure the PPTP clients. The ZyWALL initializes the PPTP connection hence; there is no need to configure the remote PPTP clients.

PPTP Protocol Overview

PPTP is very similar to L2TP, since L2TP is based on both PPTP and L2F (Cisco's Layer 2 Forwarding). Conceptually, there are three parties in PPTP, namely the PNS (PPTP Network Server), the PAC (PPTP Access Concentrator) and the PPTP user. The PNS is the box that hosts both the PPP and the PPTP stacks and forms one end of the PPTP tunnel. The PAC is the box that dials/answers the phone calls and relays the PPP frames to the PNS. The PPTP user is not necessarily a PPP client (can be a PPP server too). Both the PNS and the PAC must have IP connectivity; however, the PAC must in addition have dial-up capability. The phone call is between the user and the PAC and the PAC tunnels the PPP frames to the PNS. The PPTP user is unaware of the tunnel between the PAC and the PNS.

Figure 381 PPTP Protocol Overview

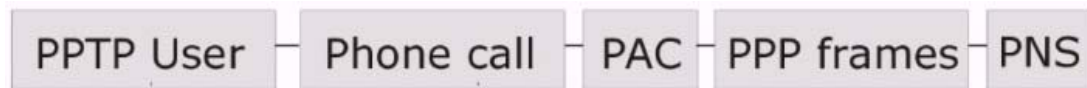

Microsoft includes PPTP as a part of the Windows OS. In Microsoft's implementation, the computer, and hence the ZyWALL, is the PNS that requests the PAC (the ANT) to place an outgoing call over AAL5 to an RFC 2364 server.

Control & PPP Connections

Each PPTP session has distinct control connection and PPP data connection.

Call Connection

The control connection runs over TCP. Similar to L2TP, a tunnel control connection is first established before call control messages can be exchanged. Please note that a tunnel control connection supports multiple call sessions.

The following diagram depicts the message exchange of a successful call setup between a computer and an ANT.

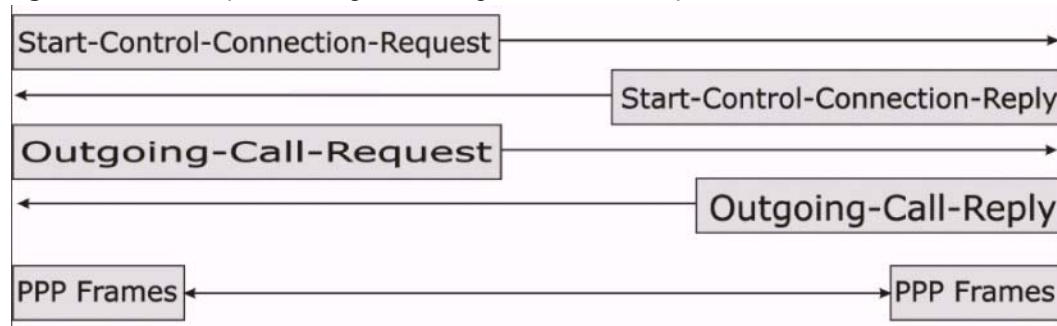
Figure 382 Example Message Exchange between Computer and an ANT

PPP Data Connection

The PPP frames are tunneled between the PNS and PAC over GRE (General Routing Encapsulation, RFC 1701, 1702). The individual calls within a tunnel are distinguished using the Call ID field in the GRE header.

Appendix G

Wireless LANs

Wireless LAN Topologies

This section discusses ad-hoc and infrastructure wireless LAN topologies.

Ad-hoc Wireless LAN Configuration

The simplest WLAN configuration is an independent (Ad-hoc) WLAN that connects a set of computers with wireless stations (A, B, C). Any time two or more wireless adapters are within range of each other, they can set up an independent network, which is commonly referred to as an Ad-hoc network or Independent Basic Service Set (IBSS). The following diagram shows an example of notebook computers using wireless adapters to form an Ad-hoc wireless LAN.

Figure 383 Peer-to-Peer Communication in an Ad-hoc Network

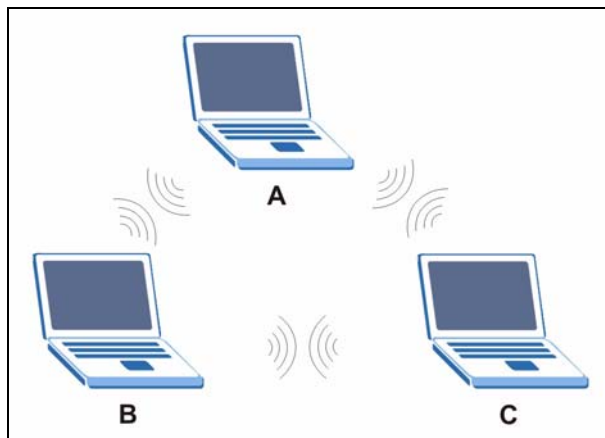

BSS

A Basic Service Set (BSS) exists when all communications between wireless stations or between a wireless station and a wired network client go through one access point (AP).

Intra-BSS traffic is traffic between wireless stations in the BSS. When Intra-BSS is enabled, wireless station A and B can access the wired network and communicate with each other. When Intra-BSS is disabled, wireless station A and B can still access the wired network but cannot communicate with each other.

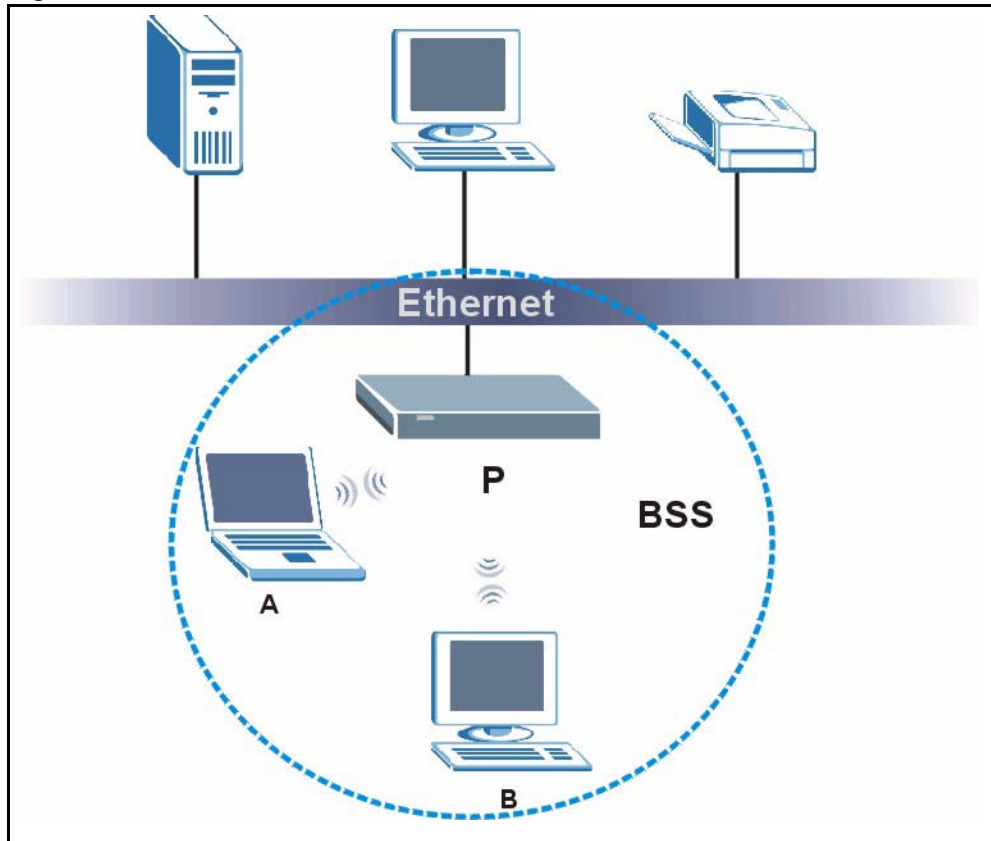
Figure 384 Basic Service Set

ESS

An Extended Service Set (ESS) consists of a series of overlapping BSSs, each containing an access point, with each access point connected together by a wired network. This wired connection between APs is called a Distribution System (DS).

This type of wireless LAN topology is called an Infrastructure WLAN. The Access Points not only provide communication with the wired network but also mediate wireless network traffic in the immediate neighborhood.

An ESSID (ESS IDentification) uniquely identifies each ESS. All access points and their associated wireless stations within the same ESS must have the same ESSID in order to communicate.

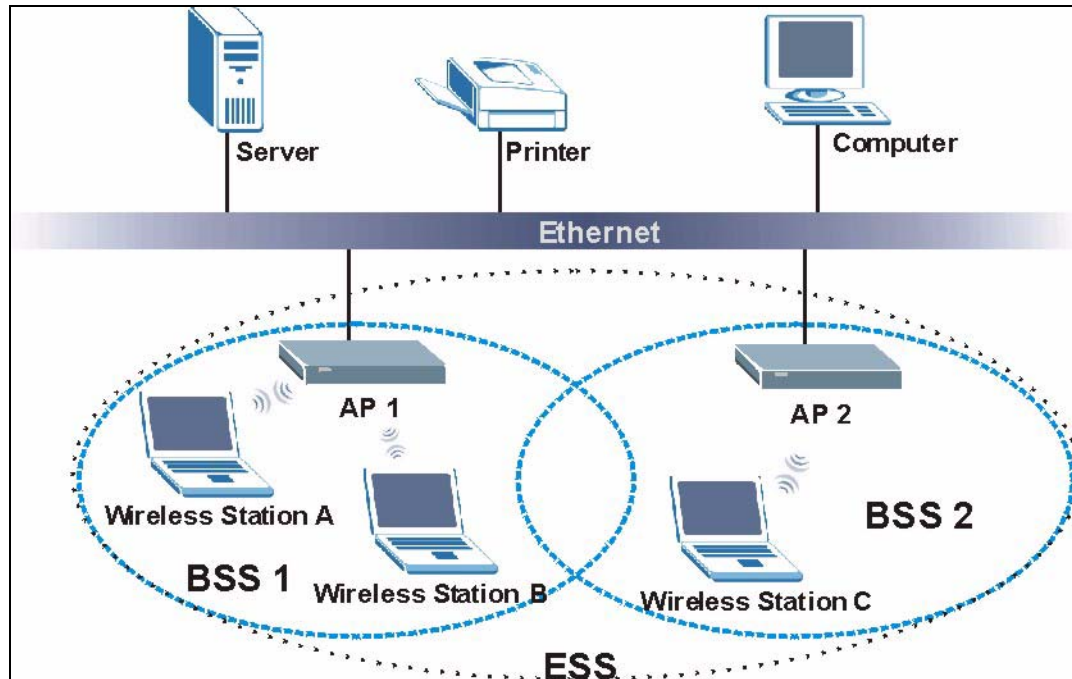
Figure 385 Infrastructure WLAN

Channel

A channel is the radio frequency(ies) used by IEEE 802.11a/b/g wireless devices. Channels available depend on your geographical area. You may have a choice of channels (for your region) so you should use a different channel than an adjacent AP (access point) to reduce interference. Interference occurs when radio signals from different access points overlap causing interference and degrading performance.

Adjacent channels partially overlap however. To avoid interference due to overlap, your AP should be on a channel at least five channels away from a channel that an adjacent AP is using. For example, if your region has 11 channels and an adjacent AP is using channel 1, then you need to select a channel between 6 or 11.

RTS/CTS

A hidden node occurs when two stations are within range of the same access point, but are not within range of each other. The following figure illustrates a hidden node. Both stations (STA) are within range of the access point (AP) or wireless gateway, but out-of-range of each other, so they cannot "hear" each other, that is they do not know if the channel is currently being used. Therefore, they are considered hidden from each other.

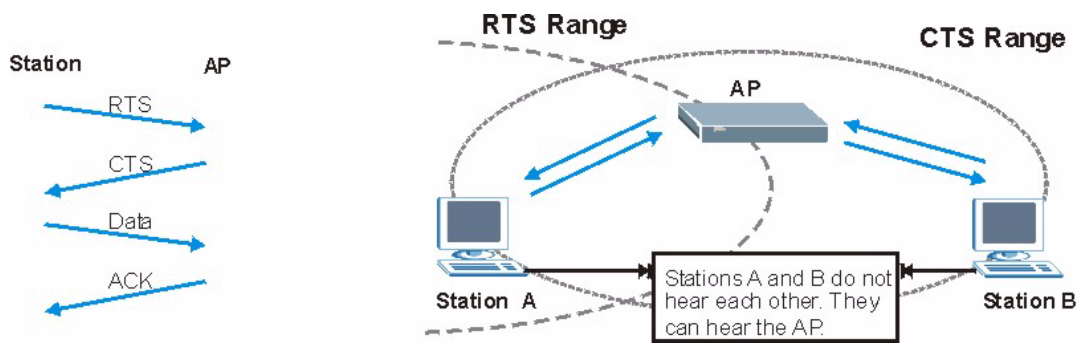
Figure 386 RTS/CTS

When station A sends data to the AP, it might not know that the station B is already using the channel. If these two stations send data at the same time, collisions may occur when both sets of data arrive at the AP at the same time, resulting in a loss of messages for both stations.

RTS/CTS is designed to prevent collisions due to hidden nodes. An **RTS/CTS** defines the biggest size data frame you can send before an RTS (Request To Send)/CTS (Clear to Send) handshake is invoked.

When a data frame exceeds the **RTS/CTS** value you set (between 0 to 2432 bytes), the station that wants to transmit this frame must first send an RTS (Request To Send) message to the AP for permission to send it. The AP then responds with a CTS (Clear to Send) message to all other stations within its range to notify them to defer their transmission. It also reserves and confirms with the requesting station the time frame for the requested transmission.

Stations can send frames smaller than the specified **RTS/CTS** directly to the AP without the RTS (Request To Send)/CTS (Clear to Send) handshake.

You should only configure **RTS/CTS** if the possibility of hidden nodes exists on your network and the "cost" of resending large frames is more than the extra network overhead involved in the RTS (Request To Send)/CTS (Clear to Send) handshake.

If the **RTS/CTS** value is greater than the **Fragmentation Threshold** value (see next), then the RTS (Request To Send)/CTS (Clear to Send) handshake will never occur as data frames will be fragmented before they reach **RTS/CTS** size.

Note: Enabling the RTS Threshold causes redundant network overhead that could negatively affect the throughput performance instead of providing a remedy.

Fragmentation Threshold

A **Fragmentation Threshold** is the maximum data fragment size (between 256 and 2432 bytes) that can be sent in the wireless network before the AP will fragment the packet into smaller data frames.

A large **Fragmentation Threshold** is recommended for networks not prone to interference while you should set a smaller threshold for busy networks or networks that are prone to interference.

If the **Fragmentation Threshold** value is smaller than the **RTS/CTS** value (see previously) you set then the RTS (Request To Send)/CTS (Clear to Send) handshake will never occur as data frames will be fragmented before they reach **RTS/CTS** size.

Preamble Type

A preamble is used to synchronize the transmission timing in your wireless network. There are two preamble modes: **Long** and **Short**.

Short preamble takes less time to process and minimizes overhead, so it should be used in a good wireless network environment when all wireless stations support it.

Select **Long** if you have a 'noisy' network or are unsure of what preamble mode your wireless stations support as all IEEE 802.11b compliant wireless adapters must support long preamble. However, not all wireless adapters support short preamble. Use long preamble if you are unsure what preamble mode the wireless adapters support, to ensure interpretability between the AP and the wireless stations and to provide more reliable communication in 'noisy' networks.

Select **Dynamic** to have the AP automatically use short preamble when all wireless stations support it, otherwise the AP uses long preamble.

Note: The AP and the wireless stations **MUST** use the same preamble mode in order to communicate.

IEEE 802.11g Wireless LAN

IEEE 802.11g is fully compatible with the IEEE 802.11b standard. This means an IEEE 802.11b adapter can interface directly with an IEEE 802.11g access point (and vice versa) at 11 Mbps or lower depending on range. IEEE 802.11g has several intermediate rate steps between the maximum and minimum data rates. The IEEE 802.11g data rate and modulation are as follows:

Table 239 IEEE802.11g

DATA RATE (MBPS)	MODULATION
1	DBPSK (Differential Binary Phase Shift Keyed)
2	DQPSK (Differential Quadrature Phase Shift Keying)
5.5 / 11	CCK (Complementary Code Keying)
6/9/12/18/24/36/48/54	OFDM (Orthogonal Frequency Division Multiplexing)

IEEE 802.1x

In June 2001, the IEEE 802.1x standard was designed to extend the features of IEEE 802.11 to support extended authentication as well as providing additional accounting and control features. It is supported by Windows XP and a number of network devices. Some advantages of IEEE 802.1x are:

- User based identification that allows for roaming.
- Support for RADIUS (Remote Authentication Dial In User Service, RFC 2138, 2139) for centralized user profile and accounting management on a network RADIUS server.
- Support for EAP (Extensible Authentication Protocol, RFC 2486) that allows additional authentication methods to be deployed with no changes to the access point or the wireless stations.

RADIUS

RADIUS is based on a client-server model that supports authentication, authorization and accounting. The access point is the client and the server is the RADIUS server. The RADIUS server handles the following tasks:

- Authentication
Determines the identity of the users.
- Authorization
Determines the network services available to authenticated users once they are connected to the network.
- Accounting
Keeps track of the client's network activity.

RADIUS is a simple package exchange in which your AP acts as a message relay between the wireless station and the network RADIUS server.

Types of RADIUS Messages

The following types of RADIUS messages are exchanged between the access point and the RADIUS server for user authentication:

- Access-Request
Sent by an access point requesting authentication.
- Access-Reject
Sent by a RADIUS server rejecting access.
- Access-Accept
Sent by a RADIUS server allowing access.

- Access-Challenge

Sent by a RADIUS server requesting more information in order to allow access. The access point sends a proper response from the user and then sends another Access-Request message.

The following types of RADIUS messages are exchanged between the access point and the RADIUS server for user accounting:

- Accounting-Request

Sent by the access point requesting accounting.

- Accounting-Response

Sent by the RADIUS server to indicate that it has started or stopped accounting.

In order to ensure network security, the access point and the RADIUS server use a shared secret key, which is a password, they both know. The key is not sent over the network. In addition to the shared key, password information exchanged is also encrypted to protect the network from unauthorized access.

EAP Authentication

EAP (Extensible Authentication Protocol) is an authentication protocol that runs on top of the IEEE802.1x transport mechanism in order to support multiple types of user authentication. By using EAP to interact with an EAP-compatible RADIUS server, the access point helps a wireless station and a RADIUS server perform authentication.

The type of authentication you use depends on the RADIUS server or the AP.

The following figure shows an overview of authentication when you specify a RADIUS server on your access point.

Figure 387 EAP Authentication

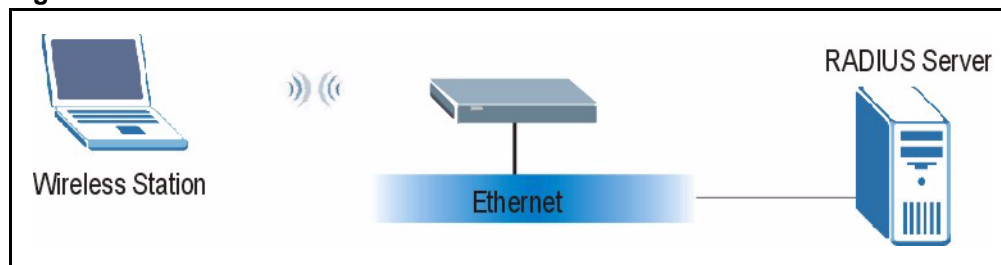

The details below provide a general description of how IEEE 802.1x EAP authentication works. For an example list of EAP-MD5 authentication steps, see the IEEE 802.1x appendix.

- 1 The wireless station sends a “start” message to the device.
- 2 The device sends a “request identity” message to the wireless station for identity information.

- 3 The wireless station replies with identity information, including username and password.
- 4 The RADIUS server checks the user information against its user profile database and determines whether or not to authenticate the wireless station.

Types of Authentication

This section discusses some popular authentication types: **EAP-MD5**, **EAP-TLS**, **EAP-TTLS**, **PEAP** and **LEAP**.

The type of authentication you use depends on the RADIUS server or the AP. Consult your network administrator for more information.

EAP-MD5 (Message-Digest Algorithm 5)

MD5 authentication is the simplest one-way authentication method. The authentication server sends a challenge to the wireless station. The wireless station 'proves' that it knows the password by encrypting the password with the challenge and sends back the information. Password is not sent in plain text.

However, MD5 authentication has some weaknesses. Since the authentication server needs to get the plaintext passwords, the passwords must be stored. Thus someone other than the authentication server may access the password file. In addition, it is possible to impersonate an authentication server as MD5 authentication method does not perform mutual authentication. Finally, MD5 authentication method does not support data encryption with dynamic session key. You must configure WEP encryption keys for data encryption.

EAP-TLS (Transport Layer Security)

With EAP-TLS, digital certifications are needed by both the server and the wireless stations for mutual authentication. The server presents a certificate to the client. After validating the identity of the server, the client sends a different certificate to the server. The exchange of certificates is done in the open before a secured tunnel is created. This makes user identity vulnerable to passive attacks. A digital certificate is an electronic ID card that authenticates the sender's identity. However, to implement EAP-TLS, you need a Certificate Authority (CA) to handle certificates, which imposes a management overhead.

EAP-TTLS (Tunneled Transport Layer Service)

EAP-TTLS is an extension of the EAP-TLS authentication that uses certificates for only the server-side authentications to establish a secure connection. Client authentication is then done by sending username and password through the secure connection, thus client identity is protected. For client authentication, EAP-TTLS supports EAP methods and legacy authentication methods such as PAP, CHAP, MS-CHAP and MS-CHAP v2.

PEAP (Protected EAP)

Like EAP-TTLS, server-side certificate authentication is used to establish a secure connection, then use simple username and password methods through the secured connection to authenticate the clients, thus hiding client identity. However, PEAP only supports EAP methods, such as EAP-MD5, EAP-MSCHAPv2 and EAP-GTC (EAP-Generic Token Card), for client authentication. EAP-GTC is implemented only by Cisco.

LEAP

LEAP (Lightweight Extensible Authentication Protocol) is a Cisco implementation of IEEE 802.1x.

WEP Encryption

WEP encryption scrambles the data transmitted between the wireless stations and the access points to keep network communications private. It encrypts unicast and multicast communications in a network. Both the wireless stations and the access points must use the same WEP key.

WEP Authentication Steps

Three different methods can be used to authenticate wireless stations to the network: **Open System**, **Shared Key**, and **Auto**. The following figure illustrates the steps involved.

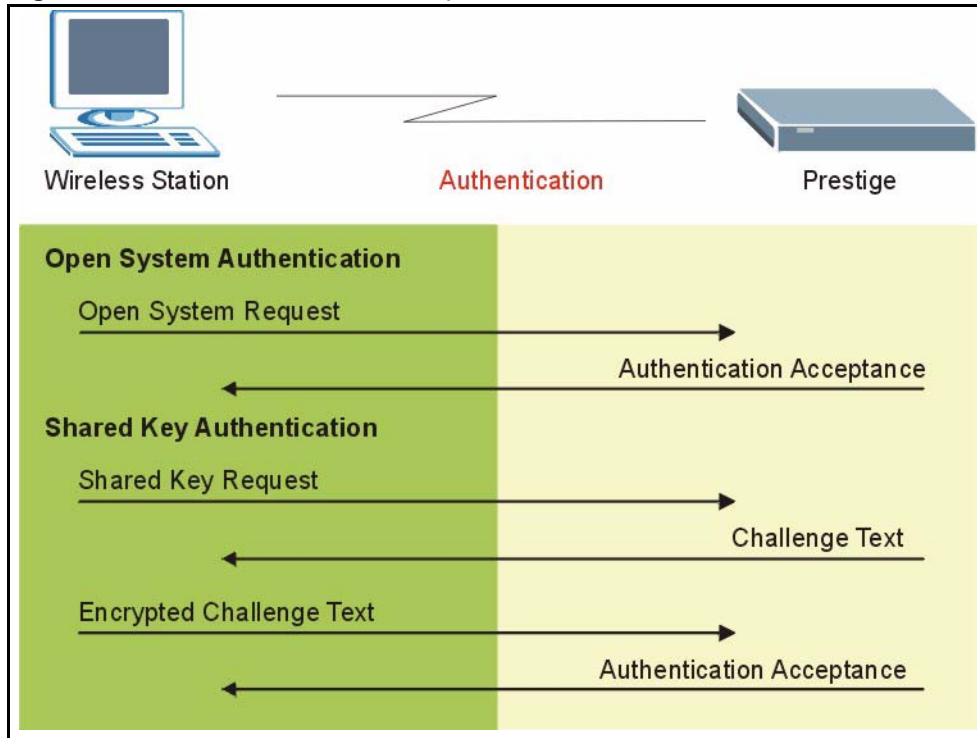
Figure 388 WEP Authentication Steps

Open system authentication involves an unencrypted two-message procedure. A wireless station sends an open system authentication request to the AP, which will then automatically accept and connect the wireless station to the network. In effect, open system is not authentication at all as any station can gain access to the network.

Shared key authentication involves a four-message procedure. A wireless station sends a shared key authentication request to the AP, which will then reply with a challenge text message. The wireless station must then use the AP's default WEP key to encrypt the challenge text and return it to the AP, which attempts to decrypt the message using the AP's default WEP key. If the decrypted message matches the challenge text, the wireless station is authenticated.

When your device authentication method is set to open system, it will only accept open system authentication requests. The same is true for shared key authentication. However, when it is set to auto authentication, the device will accept either type of authentication request and the device will fall back to use open authentication if the shared key does not match.

Dynamic WEP Key Exchange

The AP maps a unique key that is generated with the RADIUS server. This key expires when the wireless connection times out, disconnects or reauthentication times out. A new WEP key is generated each time reauthentication is performed.

If this feature is enabled, it is not necessary to configure a default encryption key in the Wireless screen. You may still configure and store keys here, but they will not be used while Dynamic WEP is enabled.

Note: EAP-MD5 cannot be used with Dynamic WEP Key Exchange

For added security, certificate-based authentications (EAP-TLS, EAP-TTLS and PEAP) use dynamic keys for data encryption. They are often deployed in corporate environments, but for public deployment, a simple user name and password pair is more practical. The following table is a comparison of the features of authentication types.

Table 240 Comparison of EAP Authentication Types

	EAP-MD5	EAP-TLS	EAP-TTLS	PEAP	LEAP
Mutual Authentication	No	Yes	Yes	Yes	Yes
Certificate – Client	No	Yes	Optional	Optional	No
Certificate – Server	No	Yes	Yes	Yes	No
Dynamic Key Exchange	No	Yes	Yes	Yes	Yes
Credential Integrity	None	Strong	Strong	Strong	Moderate
Deployment Difficulty	Easy	Hard	Moderate	Moderate	Moderate
Client Identity Protection	No	No	Yes	Yes	No

WPA

User Authentication

WPA applies IEEE 802.1x and Extensible Authentication Protocol (EAP) to authenticate wireless stations using an external RADIUS database.

Encryption

WPA improves data encryption by using Temporal Key Integrity Protocol (TKIP) or Advanced Encryption Standard (AES), Message Integrity Check (MIC) and IEEE 802.1x.

TKIP uses 128-bit keys that are dynamically generated and distributed by the authentication server. It includes a per-packet key mixing function, a Message Integrity Check (MIC) named Michael, an extended initialization vector (IV) with sequencing rules, and a re-keying mechanism.

TKIP regularly changes and rotates the encryption keys so that the same encryption key is never used twice.

The RADIUS server distributes a Pairwise Master Key (PMK) key to the AP that then sets up a key hierarchy and management system, using the PMK to dynamically generate unique data encryption keys to encrypt every data packet that is wirelessly communicated between the AP and the wireless stations. This all happens in the background automatically.

AES (Advanced Encryption Standard) also uses a secret key. This implementation of AES applies a 128-bit key to 128-bit blocks of data.

The Message Integrity Check (MIC) is designed to prevent an attacker from capturing data packets, altering them and resending them. The MIC provides a strong mathematical function in which the receiver and the transmitter each compute and then compare the MIC. If they do not match, it is assumed that the data has been tampered with and the packet is dropped.

By generating unique data encryption keys for every data packet and by creating an integrity checking mechanism (MIC), TKIP makes it much more difficult to decrypt data on a Wi-Fi network than WEP, making it difficult for an intruder to break into the network.

The encryption mechanisms used for WPA and WPA-PSK are the same. The only difference between the two is that WPA-PSK uses a simple common password, instead of user-specific credentials. The common-password approach makes WPA-PSK susceptible to brute-force password-guessing attacks but it's still an improvement over WEP as it employs an easier-to-use, consistent, single, alphanumeric password.

Security Parameters Summary

Refer to this table to see what other security parameters you should configure for each Authentication Method/ key management protocol type. MAC address filters are not dependent on how you configure these security features.

Table 241 Wireless Security Relational Matrix

AUTHENTICATION METHOD/ KEY MANAGEMENT PROTOCOL	ENCRYPTION METHOD	ENTER MANUAL KEY	ENABLE IEEE 802.1X
Open	None	No	No
Open	WEP	No	Enable with Dynamic WEP Key
		Yes	Enable without Dynamic WEP Key
		Yes	Disable
Shared	WEP	No	Enable with Dynamic WEP Key
		Yes	Enable without Dynamic WEP Key
		Yes	Disable
WPA	WEP	No	Yes
WPA	TKIP	No	Yes
WPA-PSK	WEP	Yes	Yes
WPA-PSK	TKIP	Yes	Yes

Roaming

A wireless station is a device with an IEEE 802.11 mode compliant wireless adapter. An access point (AP) acts as a bridge between the wireless and wired networks. An AP creates its own wireless coverage area. A wireless station can associate with a particular access point only if it is within the access point's coverage area.

In a network environment with multiple access points, wireless stations are able to switch from one access point to another as they move between the coverage areas. This is roaming. As the wireless station moves from place to place, it is responsible for choosing the most appropriate access point depending on the signal strength, network utilization or other factors.

The roaming feature on the access points allows the access points to relay information about the wireless stations to each other. When a wireless station moves from a coverage area to another, it scans and uses the channel of a new access point, which then informs the access points on the LAN about the change. The new information is then propagated to the other access points on the LAN. An example is shown in [Figure 389](#).

If the roaming feature is not enabled on the access points, information is not communicated between the access points when a wireless station moves between coverage areas. The wireless station may not be able to communicate with other wireless stations on the network and vice versa.

Figure 389 Roaming Example

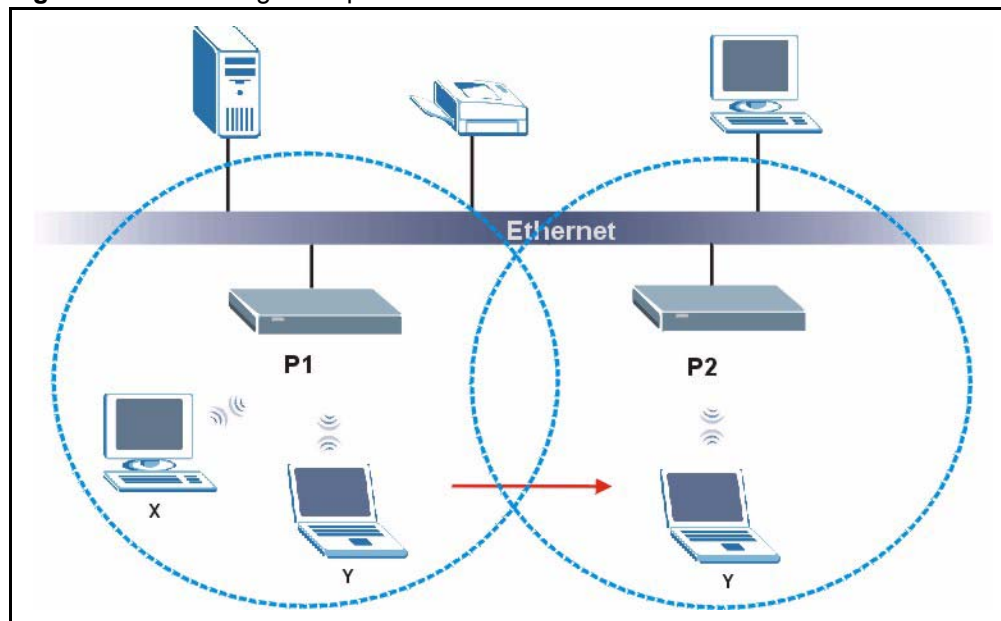

The steps below describe the roaming process.

- 1** As wireless station **Y** moves from the coverage area of access point **P1** to that of access point
- 2** **P2**, it scans and uses the signal of access point **P2**.
- 3** Access point **P2** acknowledges the presence of wireless station **Y** and relays this information to access point **P1** through the wired LAN.
- 4** Access point **P1** updates the new position of wireless station.
- 5** Wireless station **Y** sends a request to access point **P2** for re-authentication.

Requirements for Roaming

The following requirements must be met in order for wireless stations to roam between the coverage areas.

- 1** All the access points must be on the same subnet and configured with the same ESSID.
- 2** If IEEE 802.1x user authentication is enabled and to be done locally on the access point, the new access point must have the user profile for the wireless station.
- 3** The adjacent access points should use different radio channels when their coverage areas overlap.
- 4** All access points must use the same port number to relay roaming information.
- 5** The access points must be connected to the Ethernet and be able to get IP addresses from a DHCP server if using dynamic IP address assignment.

APPENDIX H

Triangle Route

The Ideal Setup

When the firewall is on, your ZyWALL acts as a secure gateway between your LAN and the Internet. In an ideal network topology, all incoming and outgoing network traffic passes through the ZyWALL to protect your LAN against attacks.

Figure 390 Ideal Setup

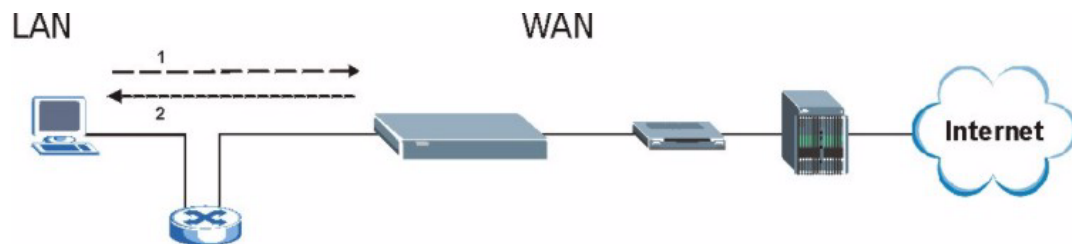

The “Triangle Route” Problem

A traffic route is a path for sending or receiving data packets between two Ethernet devices. Some companies have more than one alternate route to one or more ISPs. If the LAN and ISP(s) are in the same subnet, the “triangle route” problem may occur. The steps below describe the “triangle route” problem.

- 1** A computer on the LAN initiates a connection by sending out a SYN packet to a receiving server on the WAN.
- 2** The ZyWALL reroutes the SYN packet through Gateway **B** on the LAN to the WAN.
- 3** The reply from the WAN goes directly to the computer on the LAN without going through the ZyWALL.

As a result, the ZyWALL resets the connection, as the connection has not been acknowledged.

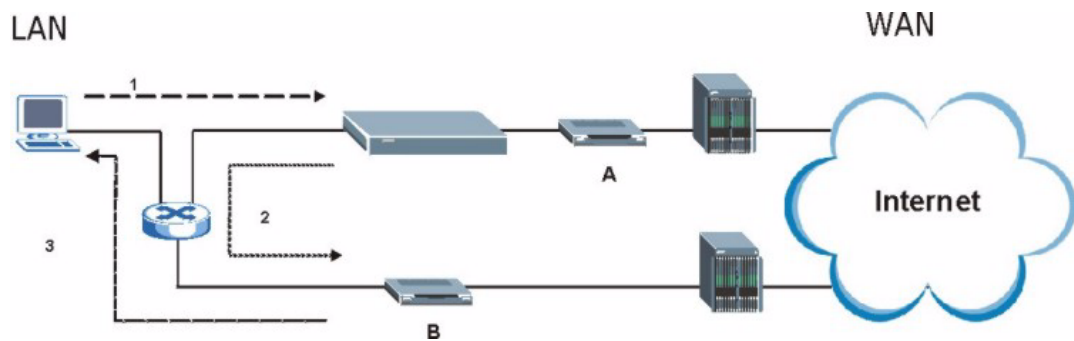
Figure 391 “Triangle Route” Problem

The “Triangle Route” Solutions

This section presents you two solutions to the “triangle route” problem.

IP Aliasing

IP alias allows you to partition your network into logical sections over the same Ethernet interface. Your ZyWALL supports up to three logical LAN interfaces with the ZyWALL being the gateway for each logical network. By putting your LAN and Gateway **B** in different subnets, all returning network traffic must pass through the ZyWALL to your LAN. The following steps describe such a scenario.

- 1** A computer on the LAN initiates a connection by sending a SYN packet to a receiving server on the WAN.
- 2** The ZyWALL reroutes the packet to Gateway B, which is in the 192.168.2.1 to 192.168.2.24 subnet.
- 3** The reply from WAN goes through the ZyWALL to the computer on the LAN in the 192.168.1.1 to 192.168.1.24 subnet.

Figure 392 IP Alias

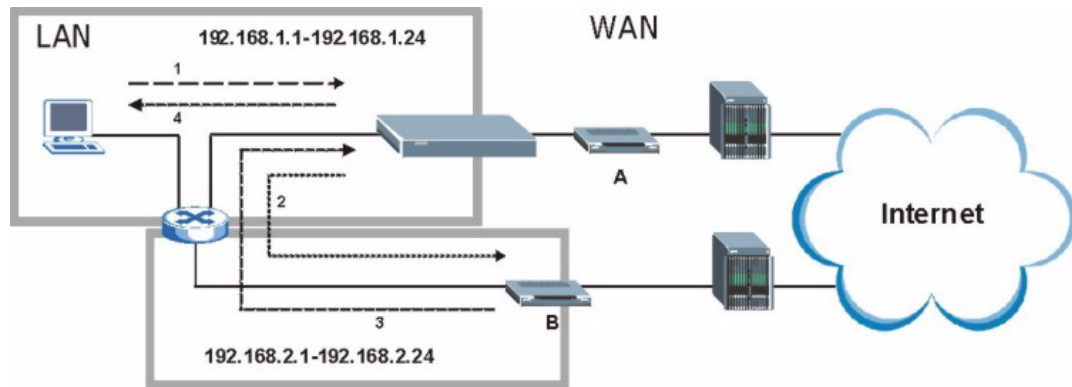

Gateways on the WAN Side

A second solution to the “triangle route” problem is to put all of your network gateways on the WAN side as the following figure shows. This ensures that all incoming network traffic passes through your ZyWALL to your LAN. Therefore your LAN is protected.

Figure 393 Gateways on the WAN Side

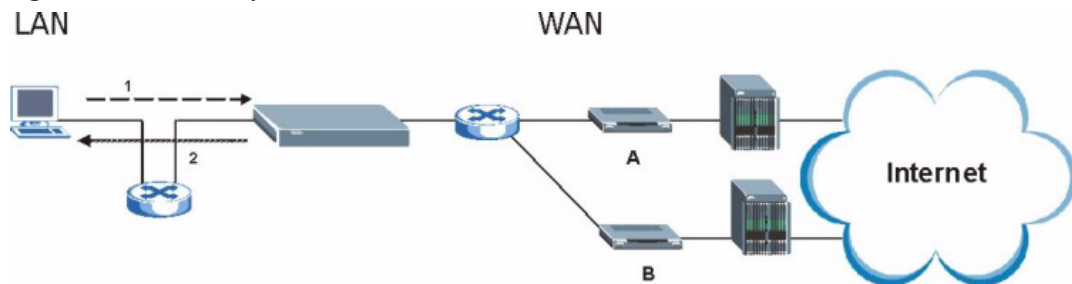

Configuring Triangle Route via Commands

- 1 From the SMT main menu, enter 24.
- 2 Enter “8” in menu 24 to enter CI command mode.
- 3 Use the following command to allow triangle route:

```
sys firewall ignore triangle all on
```

or this command to disallow triangle route:

```
sys firewall ignore triangle all off
```

APPENDIX I

SIP Passthrough

SIP

The Session Initiation Protocol (SIP) is an application-layer control (signaling) protocol that handles the setting up, altering and tearing down of voice and multimedia sessions over the Internet. SIP is used in VoIP (Voice over IP), the sending of voice signals over the Internet Protocol.

SIP signaling is separate from the media for which it handles sessions. The media that is exchanged during the session can use a different path from that of the signaling. SIP handles telephone calls and can interface with traditional circuit-switched telephone networks.

SIP Identities

A SIP account uses an identity (sometimes referred to as a SIP address). A complete SIP identity is called a SIP URI (Uniform Resource Identifier). A SIP account's URI identifies the SIP account in a way similar to the way an e-mail address identifies an e-mail account. The format of a SIP identity is SIP-Number@SIP-Service-Domain.

SIP Number

The SIP number is the part of the SIP URI that comes before the “@” symbol. A SIP number can use letters like in an e-mail address (johndoe@your-ITSP.com for example) or numbers like a telephone number (1122334455@VoIP-provider.com for example).

SIP Service Domain

The SIP service domain of the VoIP service provider is the domain name in a SIP URI. For example, if the SIP address is 1122334455@VoIP-provider.com, then “VoIP-provider.com” is the SIP service domain.

SIP Call Progression

The following figure displays the basic steps in the setup and tear down of a SIP call. A calls B.

Table 242 SIP Call Progression

A		B
1. INVITE		
		2. Ringing

Table 242 SIP Call Progression (continued)

A		B
		3. OK
4. ACK		
	5. Dialogue (voice traffic)	
6. BYE		
		7. OK

- 1** A sends a SIP INVITE request to B. This message is an invitation for B to participate in a SIP telephone call.
- 2** B sends a response indicating that the telephone is ringing.
- 3** B sends an OK response after the call is answered.
- 4** A then sends an ACK message to acknowledge that B has answered the call.
- 5** Now A and B exchange voice media (talk).
- 6** After talking, A hangs up and sends a BYE request.
- 7** B replies with an OK response confirming receipt of the BYE request and the call is terminated.

SIP Servers

SIP is a client-server protocol. A SIP client is an application program or device that sends SIP requests. A SIP server responds to the SIP requests.

When you use SIP to make a VoIP call, it originates at a client and terminates at a server. A SIP client could be a computer or a SIP phone. One device can act as both a SIP client and a SIP server.

SIP User Agent Server

A SIP user agent server can make and receive VoIP telephone calls. This means that SIP can be used for peer-to-peer communications even though it is a client-server protocol. In the following figure, either A or B can act as a SIP user agent client to initiate a call. A and B can also both act as a SIP user agent server to receive the call.

Figure 394 SIP User Agent Server

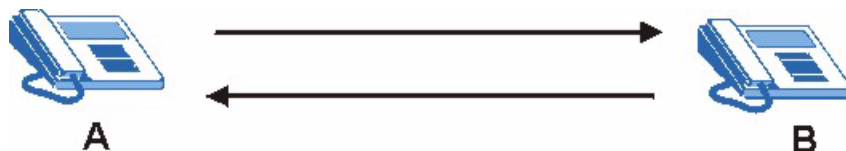

SIP Proxy Server

A SIP proxy server receives requests from clients and forwards them to another server.

In the following example, you want to use client device A to call someone who is using client device C.

- 1 The client device (A in the figure) sends a call invitation to the SIP proxy server (B).
- 2 The SIP proxy server forwards the call invitation to C.

Figure 395 SIP Proxy Server

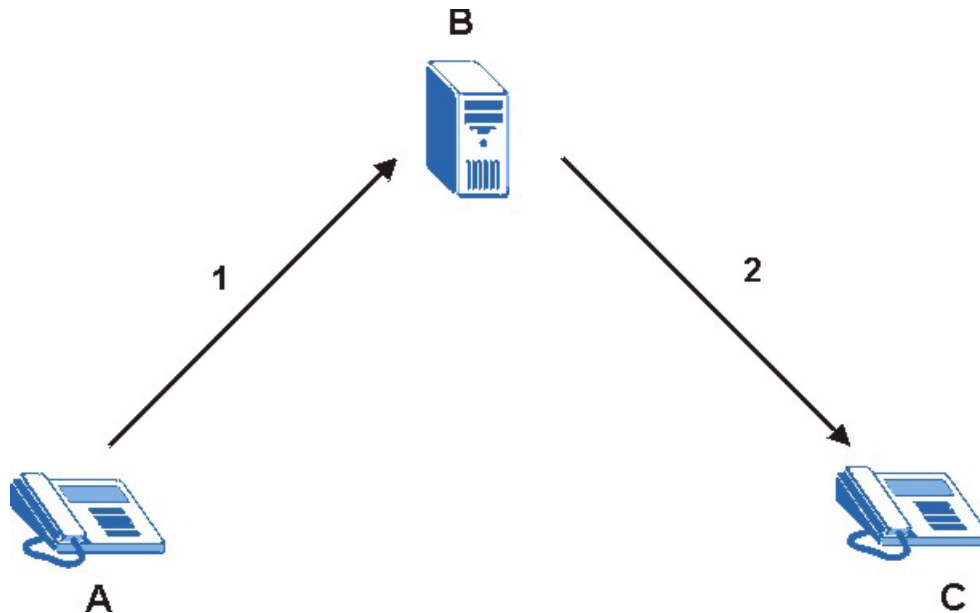

SIP Redirect Server

A SIP redirect server accepts SIP requests, translates the destination address to an IP address and sends the translated IP address back to the device that sent the request. Then the client device that originally sent the request can send requests to the IP address that it received back from the redirect server. Redirect servers do not initiate SIP requests.

In the following example, you want to use client device A to call someone who is using client device C.

- 1 Client device A sends a call invitation for C to the SIP redirect server (B).
- 2 The SIP redirect server sends the invitation back to A with C's IP address (or domain name).
- 3 Client device A then sends the call invitation to client device C.

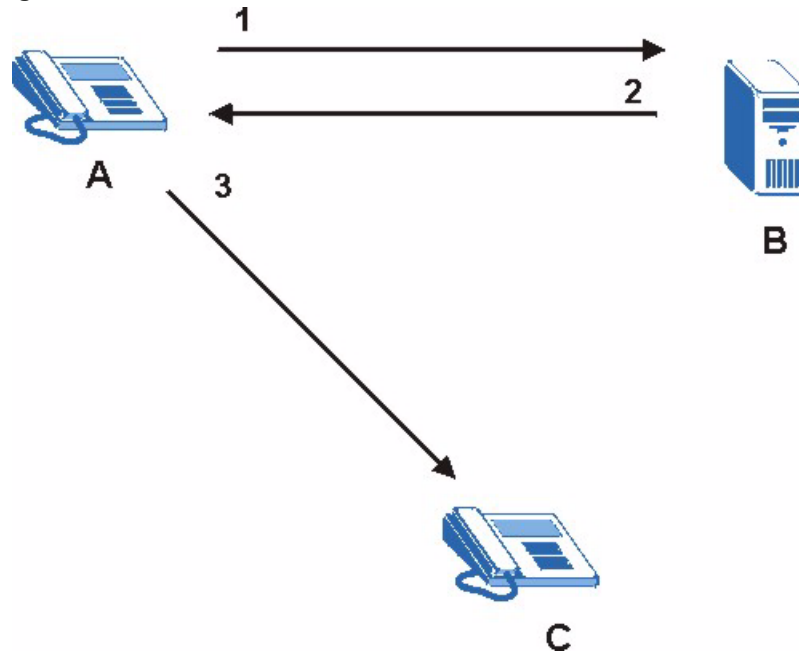
Figure 396 SIP Redirect Server

SIP Register Server

A SIP register server maintains a database of SIP identity-to-IP address (or domain name) mapping. The register server checks your user name and password when you register.

RTP

When you make a VoIP call using SIP, the RTP (Real time Transport Protocol) is used to handle voice data transfer. See RFC 1889 for details on RTP.

SIP ALG

Some NAT routers may include a SIP Application Layer Gateway (ALG). A SIP ALG allows VoIP calls to pass through NAT by examining and translating IP addresses embedded in the data stream. When a VoIP device (SIP client) behind the SIP ALG registers with the SIP register server, the SIP ALG translates the device's private IP address inside the SIP data stream to a public IP address. You do not need to use STUN if your VoIP device is behind the SIP ALG.

STUN

STUN (Simple Traversal of User Datagram Protocol (UDP) through Network Address Translators) allows the VoIP device to find the presence and types of NAT routers and/or firewalls between it and the public Internet. STUN also allows the VoIP device to find the public IP address that NAT assigned, so the VoIP device can embed it in the SIP data stream. See RFC 3489 for details on STUN.

If the primary WAN connection fails, the SIP client needs to re-register with the SIP server through the secondary WAN port to have the SIP connection go through the secondary WAN port.

When the ZyWALL uses both of the WAN ports at the same time, you can configure a routing policy to have the voice traffic from any IP address with UDP port 5060 and the RTP ports go over a specified WAN port.

Enabling/Disabling the SIP ALG

The ZyWALL SIP ALG is turned off by default to avoid retranslating the IP address of an existing SIP device that is using STUN. If you want to use a SIP client device (a SIP phone or IP phone for example) behind the ZyWALL without STUN, use the `ip alg enable ALG_SIP` command to activate the SIP ALG.

Signaling Session Timeout

Most SIP clients have an “expire” mechanism indicating the lifetime of signaling sessions. The SIP UA sends registration packets to the SIP server periodically and keeps the session alive in the ZyWALL.

If the SIP client does not have this mechanism and makes no call during the ZyWALL SIP timeout default (60 minutes), the ZyWALL SIP ALG drops any incoming calls after the timeout period. You can use the `ip alg siptimeout` command to change the timeout value.

Audio Session Timeout

If no voice packets go through the SIP ALG before the timeout period default (5 minutes) expires, the SIP ALG does not drop the call but blocks all voice traffic and deletes the audio session. You cannot hear anything and you will need to make a new call to continue your conversation.

APPENDIX J

VPN Setup

This appendix will help you to quickly create a IPSec/VPN connection between two ZyXEL IPSec routers. It should be considered a quick reference for experienced users.

General Notes

- The private networks behind the IPSec routers must be on different subnets. For example, 192.168.10.0/24 and 192.168.20.0/24.
- If the sites are/were previously connected using a leased line or ISDN router, physically disconnect these devices from the network before testing your new VPN connection. The old route may have been learnt by RIP and would take priority over the new VPN connection.
- To test whether or not a tunnel is working, ping from a computer at one site to a computer at the other. Before doing so, ensure that both computers have Internet access (via the IPSec routers).
- You can use the “E-MAIL” **Peer Type** and the “SUBNET” **Local and Remote Address Type** to simplify the configuration.
- Do not manually create any static IP routes for the remote VPN site. They are not required.

Dynamic IPSec Rule

Create a dynamic rule by setting the **Remote Gateway Address** to ‘0.0.0.0’. A single dynamic rule can support multiple simultaneous incoming IPSec connections.

All users of a dynamic rule have the same pre-shared key. You may need to change the pre-shared key if one of the users leaves. See the support notes at <http://www.zyxel.com> for configuration examples for software VPN clients.

Full Feature NAT Mode

With **Full Feature** NAT mode, you must map the intended VPN rule’s local policy addresses as the Inside Local Address (ILA) to a public IP address assigned by the ISP (an Inside Global Address or IGA) before you can configure the VPN rule. For example, you could create a One-to-One address mapping rule that maps the VPN rule’s local policy addresses as the ILA to the VPN rule’s my IP address as the IGA.

You may have to specify the public IP address in the **My ZyWALL** field of the local IPSec rule. If you have not configured the address mapping properly, a “SPD doesn’t match configuration of NAT” message displays when you try to save the IPSec rule.

The following pages show a typical configuration that builds a tunnel between two private networks. One network is the headquarters (HQ) and the other is a branch office. Both sites have static (fixed) public addresses. Replace the **Remote Gateway Address** and **Local/Remote Starting IP Address** settings with your own values.

VPN Configuration

This section gives a VPN rule configuration example using the web configurator.

- 1 Click **VPN** to display the following screen. Click the add gateway policy (🔑) icon to add an IPSec rule (or gateway policy).

Figure 398 VPN Rules

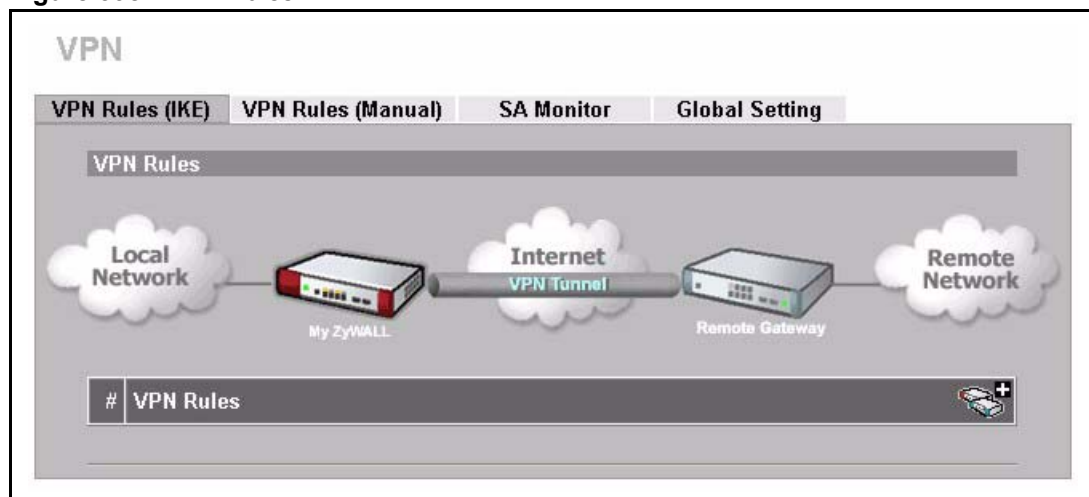

- 2 Configure the screens in the headquarters and the branch office as follows and click **Apply**.

The pre-shared key must be exactly the same on both IPSec routers. Use a simple key and/or copy and paste the setting into the other IPSec router to avoid typos.

Figure 399 Headquarters Gateway Policy Edit

VPN - GATEWAY POLICY - EDIT

Property

Name:

NAT Traversal

Gateway Policy Information

My ZyWALL

- My Address: (Domain Name or IP Address)
- My Domain Name: (See [DDNS](#))
- Remote Gateway Address:

Authentication Key

- Pre-Shared Key:
- Certificate: (See [My Certificates](#))

Local ID Type:

Content:

Peer ID Type:

Content:

Extended Authentication

Enable Extended Authentication

- Server Mode (Search [Local User](#) first then [RADIUS](#))
- Client Mode

User Name:

Password:

IKE Proposal

Negotiation Mode:

Encryption Algorithm:

Authentication Algorithm:

SA Life Time (Seconds):

Key Group:

Enable Multiple Proposals

Associated Network Policies

#	Name	Local Network	Remote Network
ex-1		192.168.10.0 / 255.255.255.0	192.168.20.0 / 255.255.255.0

Apply Cancel

The IP address of the branch

Figure 400 Branch Office Gateway Policy Edit

VPN - GATEWAY POLICY - EDIT

Property

Name

NAT Traversal

Gateway Policy Information

My ZyWALL

My Address (Domain Name or IP Address)

My Domain Name (See [DDNS](#))

Remote Gateway Address

Authentication Key

Pre-Shared Key

Certificate (See [My Certificates](#))

Local ID Type

Content

Peer ID Type

Content

Extended Authentication

Enable Extended Authentication

Server Mode (Search [Local User](#) first then [RADIUS](#))

Client Mode

User Name

Password

IKE Proposal

Negotiation Mode

Encryption Algorithm

Authentication Algorithm

SA Life Time (Seconds)

Key Group

Enable Multiple Proposals

Associated Network Policies

#	Name	Local Network	Remote Network

The IP address of the headquarters IPsec router.

3 Click the add network policy () icon next to the **BRANCH** gateway policy to configure a VPN policy.

Figure 401 Headquarters VPN Rule

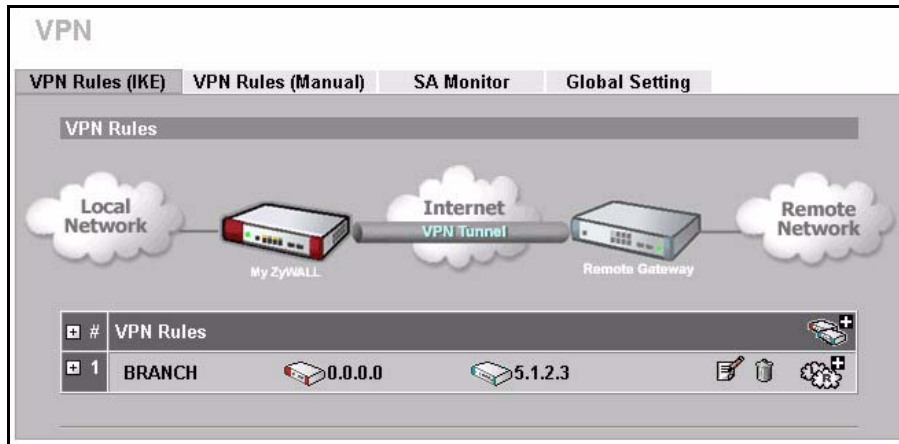
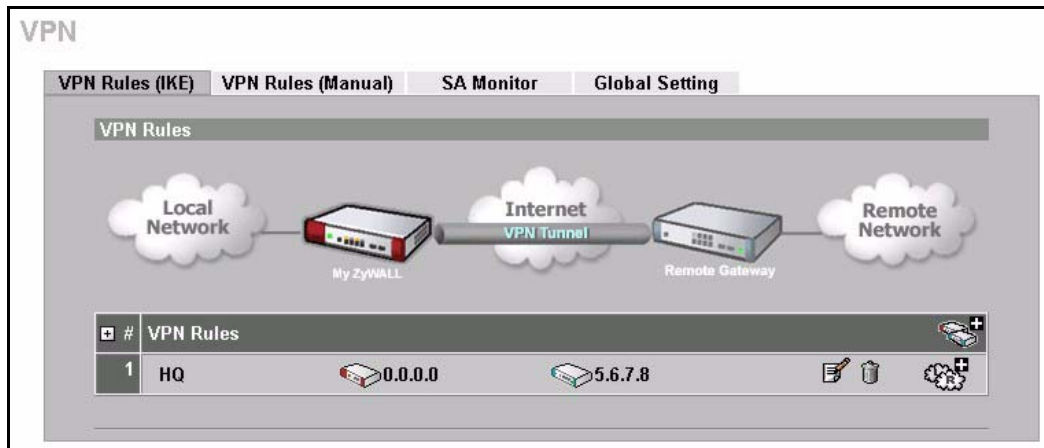

Figure 402 Branch Office VPN Rule



- 4 Configure the screens in the headquarters and the branch office as follows and click **Apply**.

Figure 403 Headquarters Network Policy Edit

VPN - NETWORK POLICY - EDIT

Property

Active

Name

Protocol

Nailed-Up

Allow NetBIOS Traffic Through IPSec Tunnel

Check IPSec Tunnel Connectivity **Log**

Ping this Address

Gateway Policy Information

Gateway Policy

Local Network

Address Type

Starting IP Address

Ending IP Address / Subnet Mask

Local Port **Start** **End**

Remote Network

Address Type

Starting IP Address

Ending IP Address / Subnet Mask

Remote Port **Start** **End**

IPSec Proposal

Encapsulation Mode

Active Protocol

Encryption Algorithm

Authentication Algorithm

SA Life Time (Seconds)

Perfect Forward Secrecy (PFS)

Enable Replay Detection

Enable Multiple Proposals

Activate the network policy.

IP addresses on different subnets.

Figure 404 Branch Office Network Policy Edit

VPN - NETWORK POLICY - EDIT

Property

Active Activate the network policy.

Name: ex-1

Protocol: 0

Nailed-Up

Allow NetBIOS Traffic Through IPSec Tunnel

Check IPSec Tunnel Connectivity Log

Ping this Address: 0 . 0 . 0 . 0

Gateway Policy Information

Gateway Policy: HQ

Local Network

Address Type: Subnet Address

Starting IP Address: 192 . 168 . 20 . 0

Ending IP Address / Subnet Mask: 255 . 255 . 255 . 0

Local Port: Start 0 End 0

Remote Network

Address Type: Subnet Address

Starting IP Address: 192 . 168 . 10 . 0

Ending IP Address / Subnet Mask: 255 . 255 . 255 . 0

Remote Port: Start 0 End 0

IPSec Proposal

Encapsulation Mode: Tunnel

Active Protocol: ESP

Encryption Algorithm: DES

Authentication Algorithm: SHA1

SA Life Time (Seconds): 28800

Perfect Forward Secrecy (PFS): NONE

Enable Replay Detection

Enable Multiple Proposals

Apply Cancel

IP addresses on different subnets.

Dialing the VPN Tunnel via Web Configurator

To test whether the IPSec routers can build the VPN tunnel, click the dial (📞) icon in the **VPN Rules (IKE)** screen to have the IPSec routers set up the tunnel.

Figure 405 VPN Rule Configured

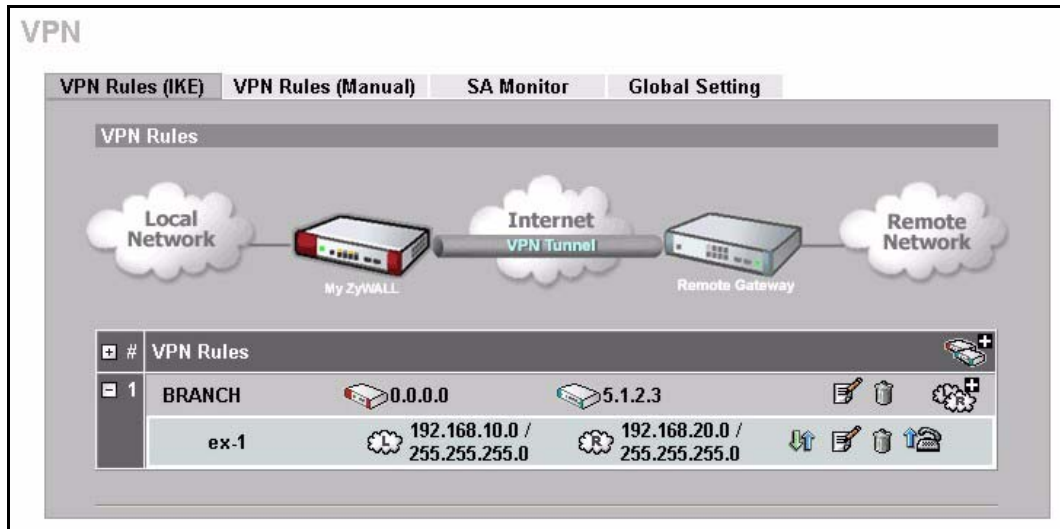

The following screen displays.

Figure 406 VPN Dial

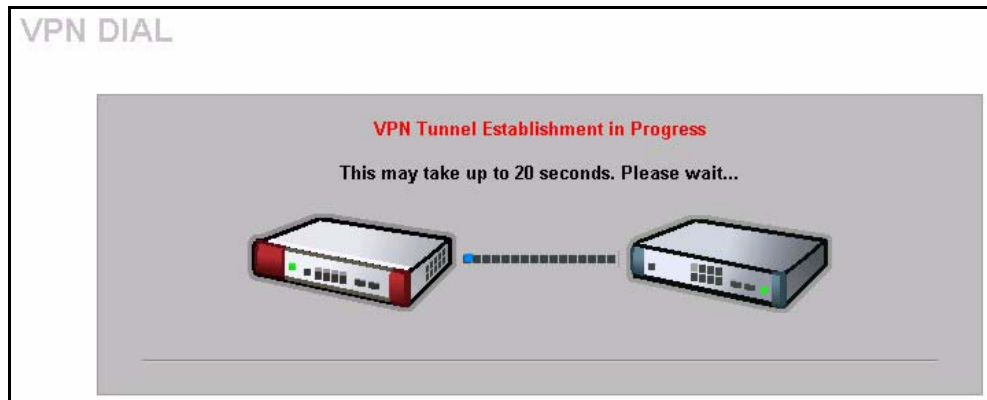

This screen displays later if the IPSec routers can build the VPN tunnel.

Figure 407 VPN Tunnel Established

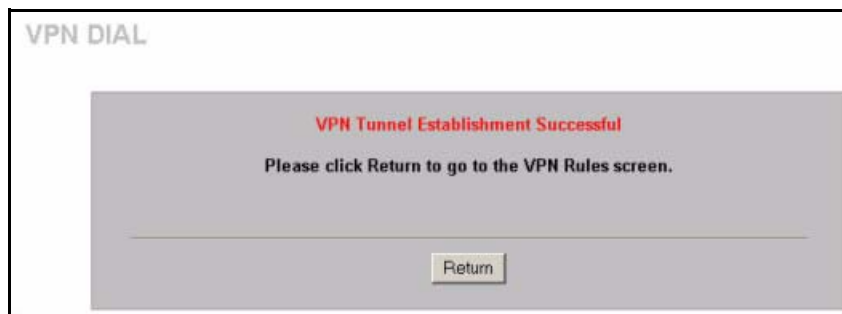

VPN Troubleshooting

If the IPSec tunnel does not build properly, the problem is likely a configuration error at one of the IPSec routers. Log into the web configurators of both ZyXEL IPSec routers. Check the settings in each field methodically and slowly.

VPN Log

The system log can often help to identify a configuration problem. Use the web configurator **LOGS Log Settings** screen to enable IKE and IPSec logging at both ends, clear the log and then build the tunnel.

View the log via the web configurator **LOGS View Log** screen or type `sys log disp` from **SMT Menu 24.8**. See [Appendix R on page 677](#) for information on the log messages.

Figure 408 VPN Log Example

```

ras> sys log disp ike ipsec

# .time          source          destination      notes
  message
0|01/11/2001 18:47:22 |5.6.7.8          |5.1.2.3          |IKE
  Rule [ex-1] Tunnel built successfully
1|01/11/2001 18:47:22 |5.6.7.8          |5.1.2.3          |IKE
  The cookie pair is : 0xDAC0B43FBDE154F5 / 0xC5156C099C3F7DCA
2|01/11/2001 18:47:22 |5.6.7.8          |5.1.2.3          |IKE
  Send:[HASH]
3|01/11/2001 18:47:22 |5.6.7.8          |5.1.2.3          |IKE
  The cookie pair is : 0xDAC0B43FBDE154F5 / 0xC5156C099C3F7DCA
4|01/11/2001 18:47:22 |5.6.7.8          |5.1.2.3          |IKE
  Adjust TCP MSS to 1398
5|01/11/2001 18:47:22 |5.1.2.3          |5.6.7.8          |IKE
  Recv:[HASH][SA][NONCE][ID][ID]
6|01/11/2001 18:47:22 |5.1.2.3          |5.6.7.8          |IKE
  The cookie pair is : 0xDAC0B43FBDE154F5 / 0xC5156C099C3F7DCA
7|01/11/2001 18:47:21 |5.6.7.8          |5.1.2.3          |IKE
  IKE Packet Retransmit
8|01/11/2001 18:47:21 |5.6.7.8          |5.1.2.3          |IKE
  The cookie pair is : 0xDAC0B43FBDE154F5 / 0xC5156C099C3F7DCA
9|01/11/2001 18:47:17 |5.6.7.8          |5.1.2.3          |IKE
  Send:[HASH][SA][NONCE][ID][ID]
10|01/11/2001 18:47:17 |5.6.7.8          |5.1.2.3          |IKE
  The cookie pair is : 0xDAC0B43FBDE154F5 / 0xC5156C099C3F7DCA
11|01/11/2001 18:47:17 |5.6.7.8          |5.1.2.3          |IKE
  Start Phase 2: Quick Mode
12|01/11/2001 18:47:17 |5.6.7.8          |5.1.2.3          |IKE
  The cookie pair is : 0xDAC0B43FBDE154F5 / 0xC5156C099C3F7DCA
13|01/11/2001 18:47:17 |5.6.7.8          |5.1.2.3          |IKE
  Phase 1 IKE SA process done
14|01/11/2001 18:47:17 |5.6.7.8          |5.1.2.3          |IKE
  The cookie pair is : 0xDAC0B43FBDE154F5 / 0xC5156C099C3F7DCA
15|01/11/2001 18:47:17 |5.1.2.3          |5.6.7.8          |IKE
  Recv:[ID][HASH][NOTFY:INIT_CONTACT]9C3F7DCA
16|01/11/2001 18:47:17 |5.1.2.3          |5.6.7.8          |IKE
  The cookie pair is : 0xDAC0B43FBDE154F5 / 0xC5156C099C3F7DCA
17|01/11/2001 18:47:15 |5.6.7.8          |5.1.2.3          |IKE
  Send:[ID][HASH][NOTFY:INIT_CONTACT]9C3F7DCA
18|01/11/2001 18:47:15 |5.6.7.8          |5.1.2.3          |IKE
  The cookie pair is : 0xDAC0B43FBDE154F5 / 0xC5156C099C3F7DCA
19|01/11/2001 18:47:15 |5.1.2.3          |5.6.7.8          |IKE
  Recv:[KE][NONCE]
20|01/11/2001 18:47:15 |5.1.2.3          |5.6.7.8          |IKE
  The cookie pair is : 0xDAC0B43FBDE154F5 / 0xC5156C099C3F7DCA
21|01/11/2001 18:47:13 |5.6.7.8          |5.1.2.3          |IKE
  Send:[KE][NONCE]
22|01/11/2001 18:47:13 |5.6.7.8          |5.1.2.3          |IKE
  The cookie pair is : 0xDAC0B43FBDE154F5 / 0xC5156C099C3F7DCA
23|01/11/2001 18:47:13 |5.1.2.3          |5.6.7.8          |IKE
  Recv:[SA][VID][VID]

```

IPSec Debug

If you are having difficulty building an IPSec tunnel to a non-ZyXEL IPSec router, advanced users may wish to examine the IPSec debug feature (**Menu 24.8**).

Note: If any of your VPN rules have an active network policy set to nailed-up, using the IPSec debug feature may cause the ZyWALL to continuously display new information. Type `ipsec debug level 0` and press [ENTER] to stop it.

Figure 409 IKE/IPSec Debug Example

```

ras> ipsec debug
type          level          display
ras> ipsec debug type
<0:Disable | 1:Original on|off | 2:IKE on|off | 3: IPsec [SPI]|on|off |
4:XAUTH on|off | 5:CERT on|off | 6: All>
ras> ipsec debug level
<0:None | 1:User | 2:Low | 3:High>

ras> ipsec debug type 1 on
ras> ipsec debug type 2 on
ras> ipsec debug level 3

ras> ipsec dial 1
get_ipsec_sa_by_policyIndex():
Start dialing for tunnel <rule# 1>...
ikeStartNegotiate(): saIndex<0>
peerIp<5.1.2.3> protocol: <IPSEC_ESP>(3)

peer Ip <5.1.2.3> initiator(): type<IPSEC_ESP>, exch<Main>

initiator :
protocol: IPSEC_ESP, exchange mode: Main mode find_ipsec_sa():
find ipsec saNot found

Not found isadb_is_outstanding_req():
isakmp is outstanding req : SA not found
isadb_create_entry(): >> INITIATOR

isadb_get_entry_by_addr():
Get IKE entry by address: SA not found

SA not found ISAKMP SA created for peer <BRANCH> size<900>

ISAKMP SA created for peer <BRANCH> size<900> ISAKMP SA built,
ikePeer.s0

ISAKMP SA built, index = 0isadb_create_entry(): done

create IKE entry doneinitiator(): find myIpAddr = 0.0.0.0, use
<5.6.7.8> r

```

Use a VPN Tunnel

A VPN tunnel gives you a secure connection to another computer or network. The **VPN Status** screen displays whether or not your VPN tunnel is connected. Example VPN tunnel uses are securely sending and retrieving files, and accessing corporate network drives, web servers and email. Services work as if you were at the office instead of connected through the Internet.

FTP Example

The following example shows a text-based login from a branch office computer to an FTP server behind the remote IPSec router at headquarters. The server's IP address (192.168.10.33) is in the subnet configured in the **Local Policy** fields in [Figure 399 on page 635](#).

```
C:\Documents and Settings\Administrator>ftp 192.168.10.33
Connected to 192.168.109.33.
220 Serv-U FTP-Server v2.5b for WinSock ready...
User (192.168.109.33:(none)): test
331 User name okay, need password.
Password:
230 User logged in, proceed.
```

APPENDIX K

Importing Certificates

This appendix shows importing certificates examples using Internet Explorer 5.

Import ZyWALL Certificates into Netscape Navigator

In Netscape Navigator, you can permanently trust the ZyWALL's server certificate by importing it into your operating system as a trusted certification authority.

Select **Accept This Certificate Permanently** in the following screen to do this.

Figure 410 Security Certificate



Importing the ZyWALL's Certificate into Internet Explorer

For Internet Explorer to trust a self-signed certificate from the ZyWALL, simply import the self-signed certificate into your operating system as a trusted certification authority.

To have Internet Explorer trust a ZyWALL certificate issued by a certificate authority, import the certificate authority's certificate into your operating system as a trusted certification authority.

The following example procedure shows how to import the ZyWALL's (self-signed) server certificate into your operating system as a trusted certification authority.

- 1 In Internet Explorer, double click the lock shown in the following screen.

Figure 411 Login Screen

2 Click **Install Certificate** to open the **Install Certificate** wizard.

Figure 412 Certificate General Information before Import

3 Click **Next** to begin the **Install Certificate** wizard.

Figure 413 Certificate Import Wizard 1

- 4 Select where you would like to store the certificate and then click **Next**.

Figure 414 Certificate Import Wizard 2

- 5 Click **Finish** to complete the **Import Certificate** wizard.

Figure 415 Certificate Import Wizard 3



6 Click **Yes** to add the ZyWALL certificate to the root store.

Figure 416 Root Certificate Store

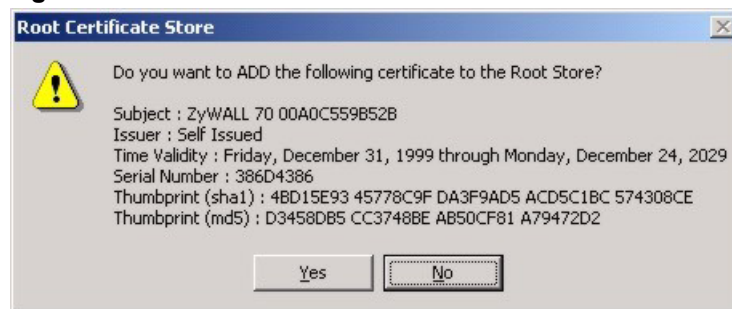

Figure 417 Certificate General Information after Import

Enrolling and Importing SSL Client Certificates

The SSL client needs a certificate if **Authenticate Client Certificates** is selected on the ZyWALL.

You must have imported at least one trusted CA to the ZyWALL in order for the **Authenticate Client Certificates** to be active (see the Certificates chapter for details).

Apply for a certificate from a Certification Authority (CA) that is trusted by the ZyWALL (see the ZyWALL's **Trusted CA** web configurator screen).

Figure 418 ZyWALL Trusted CA Screen



The CA sends you a package containing the CA's trusted certificate(s), your personal certificate(s) and a password to install the personal certificate(s).

Installing the CA's Certificate

- 1 Double click the CA's trusted certificate to produce a screen similar to the one shown next.

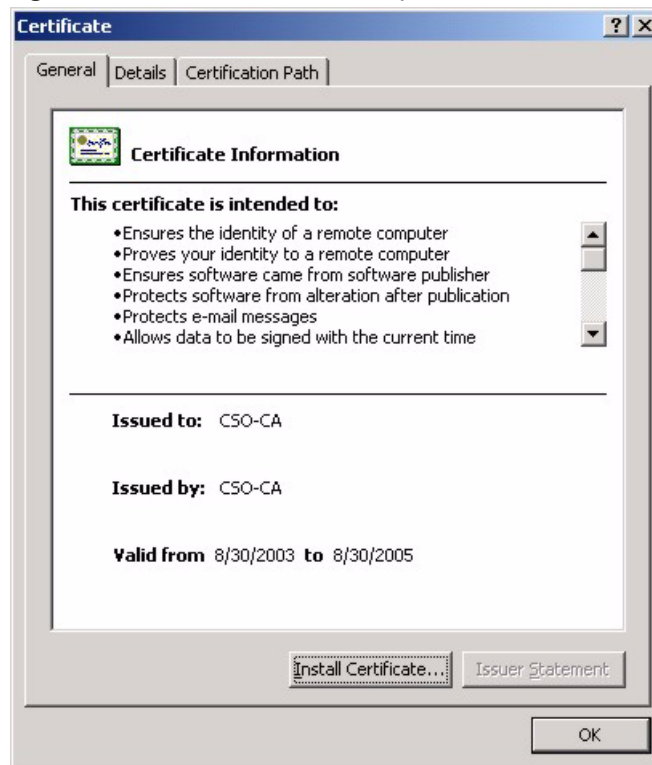
Figure 419 CA Certificate Example

2 Click **Install Certificate** and follow the wizard as shown earlier in this appendix.

Installing Your Personal Certificate(s)

You need a password in advance. The CA may issue the password or you may have to specify it during the enrollment. Double-click the personal certificate given to you by the CA to produce a screen similar to the one shown next

1 Click **Next** to begin the wizard.

Figure 420 Personal Certificate Import Wizard 1

- 2 The file name and path of the certificate you double-clicked should automatically appear in the **File name** text box. Click **Browse** if you wish to import a different certificate.

Figure 421 Personal Certificate Import Wizard 2

- 3 Enter the password given to you by the CA.

Figure 422 Personal Certificate Import Wizard 3

- 4 Have the wizard determine where the certificate should be saved on your computer or select **Place all certificates in the following store** and choose a different location.

Figure 423 Personal Certificate Import Wizard 4

- 5 Click **Finish** to complete the wizard and begin the import process.

Figure 424 Personal Certificate Import Wizard 5

- 6 You should see the following screen when the certificate is correctly installed on your computer.

Figure 425 Personal Certificate Import Wizard 6

Using a Certificate When Accessing the ZyWALL Example

Use the following procedure to access the ZyWALL via HTTPS.

- 1 Enter 'https://ZyWALL IP Address/' in your browser's web address field.

Figure 426 Access the ZyWALL Via HTTPS

- 2 When **Authenticate Client Certificates** is selected on the ZyWALL, the following screen asks you to select a personal certificate to send to the ZyWALL. This screen displays even if you only have a single certificate as in the example.

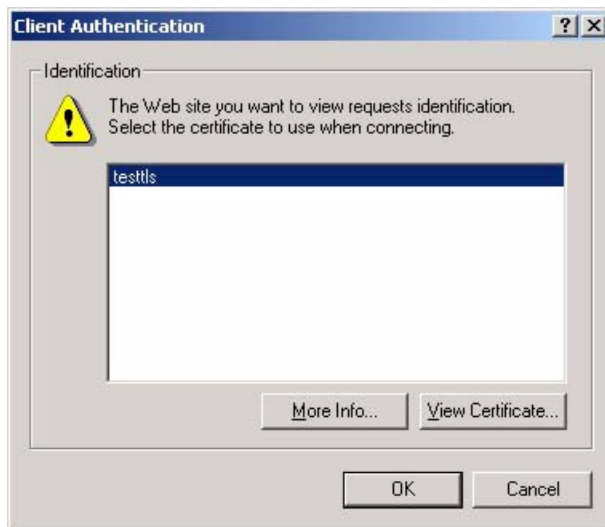
Figure 427 SSL Client Authentication

3 You next see the ZyWALL login screen.

Figure 428 ZyWALL Secure Login Screen

APPENDIX L

Command Interpreter

The following describes how to use the command interpreter. Enter 24 in the main menu to bring up the system maintenance menu. Enter 8 to go to **Menu 24.8 - Command Interpreter Mode**. See the included disk or zyxel.com for more detailed information on these commands.

Note: Use of undocumented commands or misconfiguration can damage the unit and possibly render it unusable.

Command Syntax

- The command keywords are in `courier new` font.
- Enter the command keywords exactly as shown, do not abbreviate.
- The required fields in a command are enclosed in angle brackets `<>`.
- The optional fields in a command are enclosed in square brackets `[]`.
- The `|` symbol means or.

For example,

```
sys filter netbios config <type> <on|off>
```

means that you must specify the type of netbios filter and whether to turn it on or off.

Command Usage

A list of valid commands can be found by typing `help` or `?` at the command prompt. Always type the full command. Type `exit` to return to the SMT main menu when finished.

APPENDIX M

Firewall Commands

The following describes the firewall commands. See [Appendix L on page 657](#) for information on the command structure.

Table 243 Firewall Commands

FUNCTION	COMMAND	DESCRIPTION
Firewall Set-Up		
	<code>config edit firewall active <yes no></code>	This command turns the firewall on or off.
	<code>config retrieve firewall</code>	This command returns the previously saved firewall settings.
	<code>config save firewall</code>	This command saves the current firewall settings.
Display		
	<code>config display firewall</code>	This command shows the of all the firewall settings including e-mail, attack, and the sets/rules.
	<code>config display firewall set <set #></code>	This command shows the current configuration of a set; including timeout values, name, default-permit, and etc.If you don't put use a number (#) after "set", information about all of the sets/rules appears.
	<code>config display firewall set <set #> rule <rule #></code>	This command shows the current entries of a rule in a firewall rule set.
	<code>config display firewall attack</code>	This command shows all of the attack response settings.
	<code>config display firewall e-mail</code>	This command shows all of the e-mail settings.
	<code>config display firewall ?</code>	This command shows all of the available firewall sub commands.
Edit		

Table 243 Firewall Commands (continued)

FUNCTION	COMMAND	DESCRIPTION
E-mail	<code>config edit firewall e-mail mail-server <ip address of mail server></code>	This command sets the IP address to which the e-mail messages are sent.
	<code>config edit firewall e-mail return-addr <e-mail address></code>	This command sets the source e-mail address of the firewall e-mails.
	<code>config edit firewall e-mail email-to <e-mail address></code>	This command sets the e-mail address to which the firewall e-mails are sent.
	<code>config edit firewall e-mail policy <full hourly daily weekly></code>	This command sets how frequently the firewall log is sent via e-mail.
	<code>config edit firewall e-mail day <sunday monday tuesday wednesday thursday friday saturday></code>	This command sets the day on which the current firewall log is sent through e-mail if the ZyWALL is set to send it on a weekly basis.
	<code>config edit firewall e-mail hour <0-23></code>	This command sets the hour when the firewall log is sent through e-mail if the ZyWALL is set to send it on an hourly, daily or weekly basis.
	<code>config edit firewall e-mail minute <0-59></code>	This command sets the minute of the hour for the firewall log to be sent via e-mail if the ZyWALL is set to send it on a hourly, daily or weekly basis.
Attack	<code>config edit firewall attack send-alert <yes no></code>	This command enables or disables the immediate sending of DOS attack notification e-mail messages.
	<code>config edit firewall attack block <yes no></code>	Set this command to yes to block new traffic after the tcp-max-incomplete threshold is exceeded. Set it to no to delete the oldest half-open session when traffic exceeds the tcp-max-incomplete threshold.
	<code>config edit firewall attack block-minute <0-255></code>	This command sets the number of minutes for new sessions to be blocked when the tcp-max-incomplete threshold is reached. This command is only valid when block is set to yes.

Table 243 Firewall Commands (continued)

FUNCTION	COMMAND	DESCRIPTION
	<code>config edit firewall attack minute-high <0-255></code>	This command sets the threshold rate of new half-open sessions per minute where the ZyWALL starts deleting old half-opened sessions until it gets them down to the minute-low threshold.
	<code>config edit firewall attack minute-low <0-255></code>	This command sets the threshold of half-open sessions where the ZyWALL stops deleting half-opened sessions.
	<code>config edit firewall attack max-incomplete-high <0-255></code>	This command sets the threshold of half-open sessions where the ZyWALL starts deleting old half-opened sessions until it gets them down to the max incomplete low.
	<code>config edit firewall attack max-incomplete-low <0-255></code>	This command sets the threshold where the ZyWALL stops deleting half-opened sessions.
	<code>config edit firewall attack tcp-max-incomplete <0-255></code>	This command sets the threshold of half-open TCP sessions with the same destination where the ZyWALL starts dropping half-open sessions to that destination.
Sets	<code>config edit firewall set <set #> name <desired name></code>	This command sets a name to identify a specified set.
	<code>Config edit firewall set <set #> default-permit <forward block></code>	This command sets whether a packet is dropped or allowed through, when it does not meet a rule within the set.
	<code>Config edit firewall set <set #> icmp-timeout <seconds></code>	This command sets the time period to allow an ICMP session to wait for the ICMP response.
	<code>Config edit firewall set <set #> udp-idle-timeout <seconds></code>	This command sets how long a UDP connection is allowed to remain inactive before the ZyWALL considers the connection closed.
	<code>Config edit firewall set <set #> connection-timeout <seconds></code>	This command sets how long ZyWALL waits for a TCP session to be established before dropping the session.
	<code>Config edit firewall set <set #> fin-wait-timeout <seconds></code>	This command sets how long the ZyWALL leaves a TCP session open after the firewall detects a FIN-exchange (indicating the end of the TCP session).

Table 243 Firewall Commands (continued)

FUNCTION	COMMAND	DESCRIPTION
	Config edit firewall set <set #> tcp-idle-timeout <seconds>	This command sets how long ZyWALL lets an inactive TCP connection remain open before considering it closed.
	Config edit firewall set <set #> log <yes no>	This command sets whether or not the ZyWALL creates logs for packets that match the firewall's default rule set.
Rules	Config edit firewall set <set #> rule <rule #> permit <forward block>	This command sets whether packets that match this rule are dropped or allowed through.
	Config edit firewall set <set #> rule <rule #> active <yes no>	This command sets whether a rule is enabled or not.
	Config edit firewall set <set #> rule <rule #> protocol <integer protocol value >	This command sets the protocol specification number made in this rule for ICMP.
	Config edit firewall set <set #> rule <rule #> log <none match not-match both>	This command sets the ZyWALL to log traffic that matches the rule, doesn't match, both or neither.
	Config edit firewall set <set #> rule <rule #> alert <yes no>	This command sets whether or not the ZyWALL sends an alert e-mail when a DOS attack or a violation of a particular rule occurs.
	config edit firewall set <set #> rule <rule #> srcaddr-single <ip address>	This command sets the rule to have the ZyWALL check for traffic with this individual source address.
	config edit firewall set <set #> rule <rule #> srcaddr-subnet <ip address> <subnet mask>	This command sets a rule to have the ZyWALL check for traffic from a particular subnet (defined by IP address and subnet mask).
	config edit firewall set <set #> rule <rule #> srcaddr-range <start ip address> <end ip address>	This command sets a rule to have the ZyWALL check for traffic from this range of addresses.
	config edit firewall set <set #> rule <rule #> destaddr-single <ip address>	This command sets the rule to have the ZyWALL check for traffic with this individual destination address.

Table 243 Firewall Commands (continued)

FUNCTION	COMMAND	DESCRIPTION
	<code>config edit firewall set <set #> rule <rule #> destaddr-subnet <ip address> <subnet mask></code>	This command sets a rule to have the ZyWALL check for traffic with a particular subnet destination (defined by IP address and subnet mask).
	<code>config edit firewall set <set #> rule <rule #> destaddr-range <start ip address> <end ip address></code>	This command sets a rule to have the ZyWALL check for traffic going to this range of addresses.
	<code>config edit firewall set <set #> rule <rule #> TCP destport-single <port #></code>	This command sets a rule to have the ZyWALL check for TCP traffic with this destination address. You may repeat this command to enter various, non-consecutive port numbers.
	<code>config edit firewall set <set #> rule <rule #> TCP destport-range <start port #> <end port #></code>	This command sets a rule to have the ZyWALL check for TCP traffic with a destination port in this range.
	<code>config edit firewall set <set #> rule <rule #> UDP destport-single <port #></code>	This command sets a rule to have the ZyWALL check for UDP traffic with this destination address. You may repeat this command to enter various, non-consecutive port numbers.
	<code>config edit firewall set <set #> rule <rule #> UDP destport-range <start port #> <end port #></code>	This command sets a rule to have the ZyWALL check for UDP traffic with a destination port in this range.
Delete		
	<code>config delete firewall e-mail</code>	This command removes all of the settings for e-mail alert.
	<code>config delete firewall attack</code>	This command resets all of the attack response settings to their defaults.
	<code>config delete firewall set <set #></code>	This command removes the specified set from the firewall configuration.
	<code>config delete firewall set <set #> rule<rule #></code>	This command removes the specified rule in a firewall configuration set.

APPENDIX N

NetBIOS Filter Commands

The following describes the NetBIOS packet filter commands. See [Appendix L on page 657](#) for information on the command structure.

Introduction

NetBIOS (Network Basic Input/Output System) are TCP or UDP broadcast packets that enable a computer to connect to and communicate with a LAN.

For some dial-up services such as PPPoE or PPTP, NetBIOS packets cause unwanted calls.

You can configure NetBIOS filters to do the following:

- Allow or disallow the sending of NetBIOS packets from the LAN to the WAN and from the WAN to the LAN.
- Allow or disallow the sending of NetBIOS packets from the LAN to the DMZ and from the DMZ to the LAN.
- Allow or disallow the sending of NetBIOS packets from the WAN to the DMZ and from the DMZ to the WAN.
- Allow or disallow the sending of NetBIOS packets through VPN connections.
- Allow or disallow NetBIOS packets to initiate calls.

Display NetBIOS Filter Settings

Syntax: `sys filter netbios disp`

This command gives a read-only list of the current NetBIOS filter modes for The ZyWALL.

NetBIOS Display Filter Settings Command Example

```
===== NetBIOS Filter Status =====  
Between LAN and WAN: Block  
Between LAN and DMZ: Block  
Between WAN and DMZ: Block  
IPSec Packets: Forward  
Trigger Dial: Disabled
```

The filter types and their default settings are as follows.

Table 244 NetBIOS Filter Default Settings

NAME	DESCRIPTION	EXAMPLE
Between LAN and WAN	This field displays whether NetBIOS packets are blocked or forwarded between the LAN and the WAN.	Block
Between LAN and DMZ	This field displays whether NetBIOS packets are blocked or forwarded between the LAN and the DMZ.	Block
Between WAN and DMZ	This field displays whether NetBIOS packets are blocked or forwarded between the WAN and the DMZ.	Block
IPSec Packets	This field displays whether NetBIOS packets sent through a VPN connection are blocked or forwarded.	Forward
Trigger dial	This field displays whether NetBIOS packets are allowed to initiate calls. Disabled means that NetBIOS packets are blocked from initiating calls.	Disabled

NetBIOS Filter Configuration

Syntax: `sys filter netbios config <type> <on|off>`

where

`<type>` = Identify which NetBIOS filter (numbered 0-3) to configure.

0 = Between LAN and WAN

1 = Between LAN and DMZ

2 = Between WAN and DMZ

3 = IPSec packet pass through

4 = Trigger Dial

`<on|off>` = For type 0 and 1, use on to enable the filter and block NetBIOS packets. Use off to disable the filter and forward NetBIOS packets.

For type 3, use on to block NetBIOS packets from being sent through a VPN connection. Use off to allow NetBIOS packets to be sent through a VPN connection.

For type 4, use on to allow NetBIOS packets to initiate dial backup calls. Use off to block NetBIOS packets from initiating dial backup calls.

Example commands

`sys filter netbios config 0 on` This command blocks LAN to WAN and WAN to LAN NetBIOS packets.

`sys filter netbios config 1 off` This command forwards LAN to DMZ and DMZ to LAN NetBIOS packets.

`sys filter netbios` This command blocks IPSec NetBIOS packets.
`config 3 on`

`sys filter netbios` This command stops NetBIOS commands from initiating calls.
`config 4 off`

APPENDIX O

Certificates Commands

The following describes the certificate commands. See [Appendix L on page 657](#) for information on the command structure.

All of these commands start with certificates.

Table 245 Certificates Commands

COMMAND	DESCRIPTION		
my_cert			
	create		
	create	selfsigned <name> <subject> [key size]	Create a self-signed local host certificate. <name> specifies a descriptive name for the generated certificate. <subject> specifies a subject name (required) and alternative name (required). The format is "subject-name-dn:{ip,dns,email}=value". If the name contains spaces, please put it in quotes. [key size] specifies the key size. It has to be an integer from 512 to 2048. The default is 1024 bits.
	create	request <name> <subject> [key size]	Create a certificate request and save it to the router for later manual enrollment. <name> specifies a descriptive name for the generated certification request. <subject> specifies a subject name (required) and alternative name (required). The format is "subject-name-dn:{ip,dns,email}=value". If the name contains spaces, please put it in quotes. [key size] specifies the key size. It has to be an integer from 512 to 2048. The default is 1024 bits.
	create	scep_enroll <name> <CA addr> <CA cert> <auth key> <subject> [key size]	Create a certificate request and enroll for a certificate immediately online using SCEP protocol. <name> specifies a descriptive name for the enrolled certificate. <CA addr> specifies the CA server address. <CA cert> specifies the name of the CA certificate. <auth key> specifies the key used for user authentication. If the key contains spaces, please put it in quotes. To leave it blank, type "". <subject> specifies a subject name (required) and alternative name (required). The format is "subject-name-dn:{ip,dns,email}=value". If the name contains spaces, please put it in quotes. [key size] specifies the key size. It has to be an integer from 512 to 2048. The default is 1024 bits.

Table 245 Certificates Commands (continued)

COMMAND	DESCRIPTION		
	create	cmp_enroll <name> <CA addr> <CA cert> <auth key> <subject> [key size]	Create a certificate request and enroll for a certificate immediately online using CMP protocol. <name> specifies a descriptive name for the enrolled certificate. <CA addr> specifies the CA server address. <CA cert> specifies the name of the CA certificate. <auth key> specifies the id and key used for user authentication. The format is "id:key". To leave the id and key blank, type ".". <subject> specifies a subject name (required) and alternative name (required). The format is "subject-name-dn:{ip,dns,email}=value". If the name contains spaces, please put it in quotes. [key size] specifies the key size. It has to be an integer from 512 to 2048. The default is 1024 bits.
	import	[name]	Import the PEM-encoded certificate from stdin. [name] specifies the descriptive name (optional) as which the imported certificate is to be saved. For my certificate importation to be successful, a certification request corresponding to the imported certificate must already exist on ZyWALL. After the importation, the certification request will automatically be deleted. If a descriptive name is not specified for the imported certificate, the certificate will adopt the descriptive name of the certification request.
	export	<name>	Export the PEM-encoded certificate to stdout for user to copy and paste. <name> specifies the name of the certificate to be exported.
	view	<name>	View the information of the specified local host certificate. <name> specifies the name of the certificate to be viewed.
	verify	<name> [timeout]	Verify the certification path of the specified local host certificate. <name> specifies the name of the certificate to be verified. [timeout] specifies the timeout value in seconds (optional). The default timeout value is 20 seconds.
	delete	<name>	Delete the specified local host certificate. <name> specifies the name of the certificate to be deleted.
	list		List all my certificate names and basic information.
	rename	<old name> <new name>	Rename the specified my certificate. <old name> specifies the name of the certificate to be renamed. <new name> specifies the new name as which the certificate is to be saved.
	def_self_signed	[name]	Set the specified self-signed certificate as the default self-signed certificate. [name] specifies the name of the certificate to be set as the default self-signed certificate. If [name] is not specified, the name of the current self-signed certificate is displayed.

Table 245 Certificates Commands (continued)

COMMAND	DESCRIPTION		
	replace_factory		Create a certificate using your device MAC address that will be specific to this device. The factory default certificate is a common default certificate for all ZyWALL models.
ca_trusted			
	import	<name>	Import the PEM-encoded certificate from stdin. <name> specifies the name as which the imported CA certificate is to be saved.
	export	<name>	Export the PEM-encoded certificate to stdout for user to copy and paste. <name> specifies the name of the certificate to be exported.
	view	<name>	View the information of the specified trusted CA certificate. <name> specifies the name of the certificate to be viewed.
	verify	<name> [timeout]	Verify the certification path of the specified trusted CA certificate. <name> specifies the name of the certificate to be verified. [timeout] specifies the timeout value in seconds (optional). The default timeout value is 20 seconds.
	delete	<name>	Delete the specified trusted CA certificate. <name> specifies the name of the certificate to be deleted.
	list		List all trusted CA certificate names and basic information.
	rename	<old name> <new name>	Rename the specified trusted CA certificate. <old name> specifies the name of the certificate to be renamed. <new name> specifies the new name as which the certificate is to be saved.
	crl_issuer	<name> [on off]	Specify whether or not the specified CA issues CRL. <name> specifies the name of the CA certificate. [on off] specifies whether or not the CA issues CRL. If [on off] is not specified, the current crl_issuer status of the CA.
remote_trusted			
	import	<name>	Import the PEM-encoded certificate from stdin. <name> specifies the name as which the imported remote host certificate is to be saved.
	export	<name>	Export the PEM-encoded certificate to stdout for user to copy and paste. <name> specifies the name of the certificate to be exported.
	view	<name>	View the information of the specified trusted remote host certificate. <name> specifies the name of the certificate to be viewed.
	verify	<name> [timeout]	Verify the certification path of the specified trusted remote host certificate. <name> specifies the name of the certificate to be verified. [timeout] specifies the timeout value in seconds (optional). The default timeout value is 20 seconds.

Table 245 Certificates Commands (continued)

COMMAND	DESCRIPTION		
	delete	<name>	Delete the specified trusted remote host certificate. <name> specifies the name of the certificate to be deleted.
	list		List all trusted remote host certificate names and basic information.
	rename	<old name> <new name>	Rename the specified trusted remote host certificate. <old name> specifies the name of the certificate to be renamed. <new name> specifies the new name as which the certificate is to be saved.
dir_server			
	add	<name> <addr[:port]> > [login:pswd]	Add a new directory service. <name> specifies a descriptive name as which the added directory server is to be saved. <addr[:port]> specifies the server address (required) and port (optional). The format is "server-address[:port]". The default port is 389. [login:pswd] specifies the login name and password, if required. The format is "[login:password]".
	delete	<name>	Delete the specified directory service. <name> specifies the name of the directory server to be deleted.
	view	<name>	View the specified directory service. <name> specifies the name of the directory server to be viewed.
	edit	<name> <addr[:port]> > [login:pswd]	Edit the specified directory service. <name> specifies the name of the directory server to be edited. <addr[:port]> specifies the server address (required) and port (optional). The format is "server-address[:port]". The default port is 389. [login:pswd] specifies the login name and password, if required. The format is "[login:password]".
	list		List all directory service names and basic information.
	rename	<old name> <new name>	Rename the specified directory service. <old name> specifies the name of the directory server to be renamed. <new name> specifies the new name as which the directory server is to be saved.
cert_manager			
	reinit		Reinitialize the certificate manager.

APPENDIX P

Brute-Force Password Guessing Protection

Brute-force password guessing protection allows you to specify a wait-time that must expire before entering a fourth password after three incorrect passwords have been entered.

The following describes the commands for enabling, disabling and configuring the brute-force password guessing protection mechanism for the password. See [Appendix L on page 657](#) for information on the command structure.

Table 246 Brute-Force Password Guessing Protection Commands

COMMAND	DESCRIPTION
sys pwderrtm	This command displays the brute-force guessing password protection settings.
sys pwderrtm 0	This command turns off the password's protection from brute-force guessing. The brute-force password guessing protection is turned off by default.
sys pwderrtm N	This command sets the password protection to block all access attempts for N (a number from 1 to 60) minutes after the third time an incorrect password is entered.

Example

```
sys pwderrtm 5
```

This command sets the password protection to block all access attempts for five minutes after the third time an incorrect password is entered.

APPENDIX Q

Boot Commands

The BootModule AT commands execute from within the router's bootup software, when debug mode is selected before the main router firmware is started. When you start up your ZyWALL, you are given a choice to go into debug mode by pressing a key at the prompt shown in the following screen. In debug mode you have access to a series of boot module commands, for example ATUR (for uploading firmware) and ATLC (for uploading the configuration file). These are already discussed in the **Firmware and Configuration File Maintenance** chapter.

Figure 429 Option to Enter Debug Mode

```
Bootbase Version: V1.02 | 08/08/2001 15:40:50
RAM: Size = 16384 Kbytes
DRAM Post: Testing: 16384K OK
FLASH: Intel 16M
RAS Version: V3.50(WB.0)b3 | 08/08/2001 16:21:27
Press any key to enter debug mode within 3
seconds.
.....
```

Enter ATHE to view all available ZyWALL boot module commands as shown in the next screen. ATBAx allows you to change the console port speed. The x denotes the number preceding the colon to give the console port speed following the colon in the list of numbers that follows; for example ATBA3 will give a console port speed of 9.6 Kbps. ATSE displays the seed that is used to generate a password to turn on the debug flag in the firmware. The ATSH command shows product related information such as boot module version, vendor name, product model, RAS code revision, etc. ATGO allows you to continue booting the system. Most other commands aid in advanced troubleshooting and should only be used by qualified engineers.

Figure 430 Boot Module Commands

AT	just answer OK
ATHE	print help
ATBAx	change baudrate. 1:38.4k, 2:19.2k, 3:9.6k 4:57.6k 5:115.2k
ATENx,(y)	set BootExtension Debug Flag (y=password)
ATSE	show the seed of password generator
ATTI(h,m,s)	change system time to hour:min:sec or show current time
ATDA(y,m,d)	change system date to year/month/day or show current date
ATDS	dump RAS stack
ATDT	dump Boot Module Common Area
ATDUx,y	dump memory contents from address x for length y
ATRBx	display the 8-bit value of address x
ATRWx	display the 16-bit value of address x
ATRLx	display the 32-bit value of address x
ATGO(x)	run program at addr x or boot router
ATGR	boot router
ATGT	run Hardware Test Program
ATRTw,x,y(,z)	RAM test level w, from address x to y (z iterations)
ATSH	dump manufacturer related data in ROM
ATDOx,y	download from address x for length y to PC via XMODEM
ATTD	download router configuration to PC via XMODEM
ATUR	upload router firmware to flash ROM
ATLC	upload router configuration file to flash ROM
ATXSx	xmodem select: x=0: CRC mode(default); x=1: checksum mode
ATSR	system reboot

APPENDIX R

Log Descriptions

This appendix provides descriptions of example log messages.

Table 247 System Maintenance Logs

LOG MESSAGE	DESCRIPTION
Time calibration is successful	The router has adjusted its time based on information from the time server.
Time calibration failed	The router failed to get information from the time server.
WAN interface gets IP: %s	A WAN interface got a new IP address from the DHCP, PPPoE, PPTP or dial-up server.
DHCP client IP expired	A DHCP client's IP address has expired.
DHCP server assigns %s	The DHCP server assigned an IP address to a client.
Successful SMT login	Someone has logged on to the router's SMT interface.
SMT login failed	Someone has failed to log on to the router's SMT interface.
Successful WEB login	Someone has logged on to the router's web configurator interface.
WEB login failed	Someone has failed to log on to the router's web configurator interface.
Successful TELNET login	Someone has logged on to the router via telnet.
TELNET login failed	Someone has failed to log on to the router via telnet.
Successful FTP login	Someone has logged on to the router via ftp.
FTP login failed	Someone has failed to log on to the router via ftp.
NAT Session Table is Full!	The maximum number of NAT session table entries has been exceeded and the table is full.
Starting Connectivity Monitor	Starting Connectivity Monitor.
Time initialized by Daytime Server	The router got the time and date from the Daytime server.
Time initialized by Time server	The router got the time and date from the time server.
Time initialized by NTP server	The router got the time and date from the NTP server.
Connect to Daytime server fail	The router was not able to connect to the Daytime server.
Connect to Time server fail	The router was not able to connect to the Time server.
Connect to NTP server fail	The router was not able to connect to the NTP server.
Too large ICMP packet has been dropped	The router dropped an ICMP packet that was too large.
SMT Session Begin	An SMT management session has started.
SMT Session End	An SMT management session has ended.

Table 247 System Maintenance Logs (continued)

LOG MESSAGE	DESCRIPTION
Configuration Change: PC = 0x%x, Task ID = 0x%x	The router is saving configuration changes.
Successful SSH login	Someone has logged on to the router's SSH server.
SSH login failed	Someone has failed to log on to the router's SSH server.
Successful HTTPS login	Someone has logged on to the router's web configurator interface using HTTPS protocol.
HTTPS login failed	Someone has failed to log on to the router's web configurator interface using HTTPS protocol.
DNS server %s was not responding to last 32 consecutive queries...	The specified DNS server did not respond to the last 32 consecutive queries.
DDNS update IP:%s (host %d) successfully	The device updated the IP address of the specified DDNS host name.
SMTP successfully	The device sent an e-mail.

Table 248 System Error Logs

LOG MESSAGE	DESCRIPTION
%s exceeds the max. number of session per host!	This attempt to create a NAT session exceeds the maximum number of NAT session table entries allowed to be created per host.
setNetBIOSFilter: calloc error	The router failed to allocate memory for the NetBIOS filter settings.
readNetBIOSFilter: calloc error	The router failed to allocate memory for the NetBIOS filter settings.
WAN connection is down.	A WAN connection is down. You cannot access the network through this interface.
Dial Backup starts	Dial backup started working.
Dial Backup ends	Dial backup stopped working.
DHCP Server cannot assign the static IP %S (out of range).	The LAN subnet, LAN alias 1, or LAN alias 2 was changed and the specified static DHCP IP addresses are no longer valid.
The DHCP static IP %s is conflict.	The static DHCP IP address conflicts with another host.
SMTP fail (%s)	The device failed to send an e-mail (error message included).
SMTP authentication fail (%s)	The device failed to authenticate with the SMTP server (error message included).

Table 249 Access Control Logs

LOG MESSAGE	DESCRIPTION
Firewall default policy: [TCP UDP IGMP ESP GRE OSPF] <Packet Direction>	Attempted TCP/UDP/IGMP/ESP/GRE/OSPF access matched the default policy and was blocked or forwarded according to the default policy's setting.
Firewall rule [NOT] match:[TCP UDP IGMP ESP GRE OSPF] <Packet Direction>, <rule:%d>	Attempted TCP/UDP/IGMP/ESP/GRE/OSPF access matched (or did not match) a configured firewall rule (denoted by its number) and was blocked or forwarded according to the rule.
Triangle route packet forwarded: [TCP UDP IGMP ESP GRE OSPF]	The firewall allowed a triangle route session to pass through.
Packet without a NAT table entry blocked: [TCP UDP IGMP ESP GRE OSPF]	The router blocked a packet that didn't have a corresponding NAT table entry.
Router sent blocked web site message: TCP	The router sent a message to notify a user that the router blocked access to a web site that the user requested.
Exceed maximum sessions per host (%d).	The device blocked a session because the host's connections exceeded the maximum sessions per host.
Firewall allowed a packet that matched a NAT session: [TCP UDP]	A packet from the WAN (TCP or UDP) matched a cone NAT session and the device forwarded it to the LAN.

Table 250 TCP Reset Logs

LOG MESSAGE	DESCRIPTION
Under SYN flood attack, sent TCP RST	The router sent a TCP reset packet when a host was under a SYN flood attack (the TCP incomplete count is per destination host.)
Exceed TCP MAX incomplete, sent TCP RST	The router sent a TCP reset packet when the number of TCP incomplete connections exceeded the user configured threshold. (the TCP incomplete count is per destination host.) Note: Refer to TCP Maximum Incomplete in the Firewall Attack Alerts screen.
Peer TCP state out of order, sent TCP RST	The router sent a TCP reset packet when a TCP connection state was out of order. Note: The firewall refers to RFC793 Figure 6 to check the TCP state.
Firewall session time out, sent TCP RST	The router sent a TCP reset packet when a dynamic firewall session timed out. The default timeout values are as follows: ICMP idle timeout: 3 minutes UDP idle timeout: 3 minutes TCP connection (three way handshaking) timeout: 270 seconds TCP FIN-wait timeout: 2 MSL (Maximum Segment Lifetime set in the TCP header). TCP idle (established) timeout (s): 150 minutes TCP reset timeout: 10 seconds

Table 250 TCP Reset Logs (continued)

LOG MESSAGE	DESCRIPTION
Exceed MAX incomplete, sent TCP RST	The router sent a TCP reset packet when the number of incomplete connections (TCP and UDP) exceeded the user-configured threshold. (Incomplete count is for all TCP and UDP connections through the firewall.)Note: When the number of incomplete connections (TCP + UDP) > "Maximum Incomplete High", the router sends TCP RST packets for TCP connections and destroys TOS (firewall dynamic sessions) until incomplete connections < "Maximum Incomplete Low".
Access block, sent TCP RST	The router sends a TCP RST packet and generates this log if you turn on the firewall TCP reset mechanism (via CLI command: "sys firewall tcprst").

Table 251 Packet Filter Logs

LOG MESSAGE	DESCRIPTION
[TCP UDP ICMP IGMP Generic] packet filter matched (set: %d, rule: %d)	Attempted access matched a configured filter rule (denoted by its set and rule number) and was blocked or forwarded according to the rule.

For type and code details, see [Table 266 on page 691](#).

Table 252 ICMP Logs

LOG MESSAGE	DESCRIPTION
Firewall default policy: ICMP <Packet Direction>, <type:%d>, <code:%d>	ICMP access matched the default policy and was blocked or forwarded according to the user's setting.
Firewall rule [NOT] match: ICMP <Packet Direction>, <rule:%d>, <type:%d>, <code:%d>	ICMP access matched (or didn't match) a firewall rule (denoted by its number) and was blocked or forwarded according to the rule.
Triangle route packet forwarded: ICMP	The firewall allowed a triangle route session to pass through.
Packet without a NAT table entry blocked: ICMP	The router blocked a packet that didn't have a corresponding NAT table entry.
Unsupported/out-of-order ICMP: ICMP	The firewall does not support this kind of ICMP packets or the ICMP packets are out of order.
Router reply ICMP packet: ICMP	The router sent an ICMP reply packet to the sender.

Table 253 CDR Logs

LOG MESSAGE	DESCRIPTION
board %d line %d channel %d, call %d, %s C01 Outgoing Call dev=%x ch=%x %s	The router received the setup requirements for a call. "call" is the reference (count) number of the call. "dev" is the device type (3 is for dial-up, 6 is for PPPoE, 10 is for PPTP). "channel" or "ch" is the call channel ID. For example, "board 0 line 0 channel 0, call 3, C01 Outgoing Call dev=6 ch=0" Means the router has dialed to the PPPoE server 3 times.
board %d line %d channel %d, call %d, %s C02 OutCall Connected %d %s	The PPPoE, PPTP or dial-up call is connected.
board %d line %d channel %d, call %d, %s C02 Call Terminated	The PPPoE, PPTP or dial-up call was disconnected.

Table 254 PPP Logs

LOG MESSAGE	DESCRIPTION
ppp:LCP Starting	The PPP connection's Link Control Protocol stage has started.
ppp:LCP Opening	The PPP connection's Link Control Protocol stage is opening.
ppp:CHAP Opening	The PPP connection's Challenge Handshake Authentication Protocol stage is opening.
ppp:IPCP Starting	The PPP connection's Internet Protocol Control Protocol stage is starting.
ppp:IPCP Opening	The PPP connection's Internet Protocol Control Protocol stage is opening.
ppp:LCP Closing	The PPP connection's Link Control Protocol stage is closing.
ppp:IPCP Closing	The PPP connection's Internet Protocol Control Protocol stage is closing.

Table 255 UPnP Logs

LOG MESSAGE	DESCRIPTION
UPnP pass through Firewall	UPnP packets can pass through the firewall.

Table 256 Content Filtering Logs

LOG MESSAGE	DESCRIPTION
%s: Keyword blocking	The content of a requested web page matched a user defined keyword.
%s: Not in trusted web list	The web site is not in a trusted domain, and the router blocks all traffic except trusted domain sites.

Table 256 Content Filtering Logs (continued)

LOG MESSAGE	DESCRIPTION
%s: Forbidden Web site	The web site is in the forbidden web site list.
%s: Contains ActiveX	The web site contains ActiveX.
%s: Contains Java applet	The web site contains a Java applet.
%s: Contains cookie	The web site contains a cookie.
%s: Proxy mode detected	The router detected proxy mode in the packet.
%s	The content filter server responded that the web site is in the blocked category list, but it did not return the category type.
%s: %s	The content filter server responded that the web site is in the blocked category list, and returned the category type.
%s (cache hit)	The system detected that the web site is in the blocked list from the local cache, but does not know the category type.
%s :%s (cache hit)	The system detected that the web site is in blocked list from the local cache, and knows the category type.
%s: Trusted Web site	The web site is in a trusted domain.
%s	When the content filter is not on according to the time schedule or you didn't select the "Block Matched Web Site" checkbox, the system forwards the web content.
Waiting content filter server timeout	The external content filtering server did not respond within the timeout period.
DNS resolving failed	The ZyWALL cannot get the IP address of the external content filtering via DNS query.
Creating socket failed	The ZyWALL cannot issue a query because TCP/IP socket creation failed, port:port number.
Connecting to content filter server fail	The connection to the external content filtering server failed.
License key is invalid	The external content filtering license key is invalid.

For type and code details, see [Table 266 on page 691](#).

Table 257 Attack Logs

LOG MESSAGE	DESCRIPTION
attack [TCP UDP IGMP ESP GRE OSPF]	The firewall detected a TCP/UDP/IGMP/ESP/GRE/OSPF attack.
attack ICMP (type:%d, code:%d)	The firewall detected an ICMP attack.
land [TCP UDP IGMP ESP GRE OSPF]	The firewall detected a TCP/UDP/IGMP/ESP/GRE/OSPF land attack.
land ICMP (type:%d, code:%d)	The firewall detected an ICMP land attack.
ip spoofing - WAN [TCP UDP IGMP ESP GRE OSPF]	The firewall detected an IP spoofing attack on the WAN port.

Table 257 Attack Logs (continued)

LOG MESSAGE	DESCRIPTION
ip spoofing - WAN ICMP (type:%d, code:%d)	The firewall detected an ICMP IP spoofing attack on the WAN port.
icmp echo : ICMP (type:%d, code:%d)	The firewall detected an ICMP echo attack.
syn flood TCP	The firewall detected a TCP syn flood attack.
ports scan TCP	The firewall detected a TCP port scan attack.
teardrop TCP	The firewall detected a TCP teardrop attack.
teardrop UDP	The firewall detected an UDP teardrop attack.
teardrop ICMP (type:%d, code:%d)	The firewall detected an ICMP teardrop attack.
illegal command TCP	The firewall detected a TCP illegal command attack.
NetBIOS TCP	The firewall detected a TCP NetBIOS attack.
ip spoofing - no routing entry [TCP UDP IGMP ESP GRE OSPF]	The firewall classified a packet with no source routing entry as an IP spoofing attack.
ip spoofing - no routing entry ICMP (type:%d, code:%d)	The firewall classified an ICMP packet with no source routing entry as an IP spoofing attack.
vulnerability ICMP (type:%d, code:%d)	The firewall detected an ICMP vulnerability attack.
traceroute ICMP (type:%d, code:%d)	The firewall detected an ICMP traceroute attack.
ports scan UDP	The firewall detected a UDP port scan attack.
Firewall sent TCP packet in response to DoS attack TCP	The firewall sent TCP packet in response to a DoS attack
ICMP Source Quench ICMP	The firewall detected an ICMP Source Quench attack.
ICMP Time Exceed ICMP	The firewall detected an ICMP Time Exceed attack.
ICMP Destination Unreachable ICMP	The firewall detected an ICMP Destination Unreachable attack.
ping of death. ICMP	The firewall detected an ICMP ping of death attack.
smurf ICMP	The firewall detected an ICMP smurf attack.

Table 258 Remote Management Logs

LOG MESSAGE	DESCRIPTION
Remote Management: FTP denied	Attempted use of FTP service was blocked according to remote management settings.
Remote Management: TELNET denied	Attempted use of TELNET service was blocked according to remote management settings.
Remote Management: HTTP or UPnP denied	Attempted use of HTTP or UPnP service was blocked according to remote management settings.

Table 258 Remote Management Logs

LOG MESSAGE	DESCRIPTION
Remote Management: WWW denied	Attempted use of WWW service was blocked according to remote management settings.
Remote Management: HTTPS denied	Attempted use of HTTPS service was blocked according to remote management settings.
Remote Management: SSH denied	Attempted use of SSH service was blocked according to remote management settings.
Remote Management: ICMP Ping response denied	Attempted use of ICMP service was blocked according to remote management settings.
Remote Management: SNMP denied	Attempted use of SNMP service was blocked according to remote management settings.
Remote Management: DNS denied	Attempted use of DNS service was blocked according to remote management settings.

Table 259 Wireless Logs

LOG MESSAGE	DESCRIPTION
WLAN MAC Filter Fail	The MAC filter blocked a wireless station from connecting to the device.
WLAN MAC Filter Success	The MAC filter allowed a wireless station to connect to the device.
WLAN STA Association	A wireless station associated with the device.
WLAN STA Association List Full	The maximum number of associated wireless clients has been reached.
WLAN STA Association Again	The SSID and time of association were updated for an wireless station that was already associated.

Table 260 IPSec Logs

LOG MESSAGE	DESCRIPTION
Discard REPLAY packet	The router received and discarded a packet with an incorrect sequence number.
Inbound packet authentication failed	The router received a packet that has been altered. A third party may have altered or tampered with the packet.
Receive IPSec packet, but no corresponding tunnel exists	The router dropped an inbound packet for which SPI could not find a corresponding phase 2 SA.

Table 260 IPSec Logs (continued)

LOG MESSAGE	DESCRIPTION
Rule <%d> idle time out, disconnect	The router dropped a connection that had outbound traffic and no inbound traffic for a certain time period. You can use the "ipsec timer chk_conn" CLI command to set the time period. The default value is 2 minutes.
WAN IP changed to <IP>	The router dropped all connections with the "MyIP" configured as "0.0.0.0" when the WAN IP address changed.
Inbound packet decryption failed	Please check the algorithm configuration.
Cannot find outbound SA for rule <%d>	A packet matches a rule, but there is no phase 2 SA for outbound traffic.
Rule [%s] sends an echo request to peer	The device sent a ping packet to check the specified VPN tunnel's connectivity.
Rule [%s] receives an echo reply from peer	The device received a ping response when checking the specified VPN tunnel's connectivity.

Table 261 IKE Logs

LOG MESSAGE	DESCRIPTION
Active connection allowed exceeded	The IKE process for a new connection failed because the limit of simultaneous phase 2 SAs has been reached.
Start Phase 2: Quick Mode	Phase 2 Quick Mode has started.
Verifying Remote ID failed:	The connection failed during IKE phase 2 because the router and the peer's Local/Remote Addresses don't match.
Verifying Local ID failed:	The connection failed during IKE phase 2 because the router and the peer's Local/Remote Addresses don't match.
IKE Packet Retransmit	The router retransmitted the last packet sent because there was no response from the peer.
Failed to send IKE Packet	An Ethernet error stopped the router from sending IKE packets.
Too many errors! Deleting SA	An SA was deleted because there were too many errors.
Phase 1 IKE SA process done	The phase 1 IKE SA process has been completed.
Duplicate requests with the same cookie	The router received multiple requests from the same peer while still processing the first IKE packet from the peer.
IKE Negotiation is in process	The router has already started negotiating with the peer for the connection, but the IKE process has not finished yet.
No proposal chosen	Phase 1 or phase 2 parameters don't match. Please check all protocols / settings. Ex. One device being configured for 3DES and the other being configured for DES causes the connection to fail.
Local / remote IPs of incoming request conflict with rule <%d>	The security gateway is set to "0.0.0.0" and the router used the peer's "Local Address" as the router's "Remote Address". This information conflicted with static rule #d; thus the connection is not allowed.
Cannot resolve Secure Gateway Addr for rule <%d>	The router couldn't resolve the IP address from the domain name that was used for the secure gateway address.

Table 261 IKE Logs (continued)

LOG MESSAGE	DESCRIPTION
Peer ID: <peer id> <My remote type> -<My local type>	The displayed ID information did not match between the two ends of the connection.
vs. My Remote <My remote> -<My remote>	The displayed ID information did not match between the two ends of the connection.
vs. My Local <My local>-<My local>	The displayed ID information did not match between the two ends of the connection.
Send <packet>	A packet was sent.
Recv <packet>	IKE uses ISAKMP to transmit data. Each ISAKMP packet contains many different types of payloads. All of them show in the LOG. Refer to RFC2408 – ISAKMP for a list of all ISAKMP payload types.
Recv <Main or Aggressive> Mode request from <IP>	The router received an IKE negotiation request from the peer address specified.
Send <Main or Aggressive> Mode request to <IP>	The router started negotiation with the peer.
Invalid IP <Peer local> / <Peer local>	The peer's "Local IP Address" is invalid.
Remote IP <Remote IP> / <Remote IP> conflicts	The security gateway is set to "0.0.0.0" and the router used the peer's "Local Address" as the router's "Remote Address". This information conflicted with static rule #d; thus the connection is not allowed.
Phase 1 ID type mismatch	This router's "Peer ID Type" is different from the peer IPsec router's "Local ID Type".
Phase 1 ID content mismatch	This router's "Peer ID Content" is different from the peer IPsec router's "Local ID Content".
No known phase 1 ID type found	The router could not find a known phase 1 ID in the connection attempt.
ID type mismatch. Local / Peer: <Local ID type/Peer ID type>	The phase 1 ID types do not match.
ID content mismatch	The phase 1 ID contents do not match.
Configured Peer ID Content: <Configured Peer ID Content>	The phase 1 ID contents do not match and the configured "Peer ID Content" is displayed.
Incoming ID Content: <Incoming Peer ID Content>	The phase 1 ID contents do not match and the incoming packet's ID content is displayed.
Unsupported local ID Type: <%d>	The phase 1 ID type is not supported by the router.
Build Phase 1 ID	The router has started to build the phase 1 ID.
Adjust TCP MSS to %d	The router automatically changed the TCP Maximum Segment Size value after establishing a tunnel.
Rule <%d> input idle time out, disconnect	The tunnel for the listed rule was dropped because there was no inbound traffic within the idle timeout period.
XAUTH succeed! Username: <Username>	The router used extended authentication to authenticate the listed username.
XAUTH fail! Username: <Username>	The router was not able to use extended authentication to authenticate the listed username.

Table 261 IKE Logs (continued)

LOG MESSAGE	DESCRIPTION
Rule[%d] Phase 1 negotiation mode mismatch	The listed rule's IKE phase 1 negotiation mode did not match between the router and the peer.
Rule [%d] Phase 1 encryption algorithm mismatch	The listed rule's IKE phase 1 encryption algorithm did not match between the router and the peer.
Rule [%d] Phase 1 authentication algorithm mismatch	The listed rule's IKE phase 1 authentication algorithm did not match between the router and the peer.
Rule [%d] Phase 1 authentication method mismatch	The listed rule's IKE phase 1 authentication method did not match between the router and the peer.
Rule [%d] Phase 1 key group mismatch	The listed rule's IKE phase 1 key group did not match between the router and the peer.
Rule [%d] Phase 2 protocol mismatch	The listed rule's IKE phase 2 protocol did not match between the router and the peer.
Rule [%d] Phase 2 encryption algorithm mismatch	The listed rule's IKE phase 2 encryption algorithm did not match between the router and the peer.
Rule [%d] Phase 2 authentication algorithm mismatch	The listed rule's IKE phase 2 authentication algorithm did not match between the router and the peer.
Rule [%d] Phase 2 encapsulation mismatch	The listed rule's IKE phase 2 encapsulation did not match between the router and the peer.
Rule [%d]> Phase 2 pfs mismatch	The listed rule's IKE phase 2 perfect forward secret (pfs) setting did not match between the router and the peer.
Rule [%d] Phase 1 ID mismatch	The listed rule's IKE phase 1 ID did not match between the router and the peer.
Rule [%d] Phase 1 hash mismatch	The listed rule's IKE phase 1 hash did not match between the router and the peer.
Rule [%d] Phase 1 preshared key mismatch	The listed rule's IKE phase 1 pre-shared key did not match between the router and the peer.
Rule [%d] Tunnel built successfully	The listed rule's IPsec tunnel has been built successfully.
Rule [%d] Peer's public key not found	The listed rule's IKE phase 1 peer's public key was not found.
Rule [%d] Verify peer's signature failed	The listed rule's IKE phase 1 verification of the peer's signature failed.
Rule [%d] Sending IKE request	IKE sent an IKE request for the listed rule.
Rule [%d] Receiving IKE request	IKE received an IKE request for the listed rule.
Swap rule to rule [%d]	The router changed to using the listed rule.
Rule [%d] Phase 1 key length mismatch	The listed rule's IKE phase 1 key length (with the AES encryption algorithm) did not match between the router and the peer.
Rule [%d] phase 1 mismatch	The listed rule's IKE phase 1 did not match between the router and the peer.

Table 261 IKE Logs (continued)

LOG MESSAGE	DESCRIPTION
Rule [%d] phase 2 mismatch	The listed rule's IKE phase 2 did not match between the router and the peer.
Rule [%d] Phase 2 key length mismatch	The listed rule's IKE phase 2 key lengths (with the AES encryption algorithm) did not match between the router and the peer.

Table 262 PKI Logs

LOG MESSAGE	DESCRIPTION
Enrollment successful	The SCEP online certificate enrollment was successful. The Destination field records the certification authority server IP address and port.
Enrollment failed	The SCEP online certificate enrollment failed. The Destination field records the certification authority server's IP address and port.
Failed to resolve <SCEP CA server url>	The SCEP online certificate enrollment failed because the certification authority server's address cannot be resolved.
Enrollment successful	The CMP online certificate enrollment was successful. The Destination field records the certification authority server's IP address and port.
Enrollment failed	The CMP online certificate enrollment failed. The Destination field records the certification authority server's IP address and port.
Failed to resolve <CMP CA server url>	The CMP online certificate enrollment failed because the certification authority server's IP address cannot be resolved.
Rcvd ca cert: <subject name>	The router received a certification authority certificate, with subject name as recorded, from the LDAP server whose IP address and port are recorded in the Source field.
Rcvd user cert: <subject name>	The router received a user certificate, with subject name as recorded, from the LDAP server whose IP address and port are recorded in the Source field.
Rcvd CRL <size>: <issuer name>	The router received a CRL (Certificate Revocation List), with size and issuer name as recorded, from the LDAP server whose IP address and port are recorded in the Source field.
Rcvd ARL <size>: <issuer name>	The router received an ARL (Authority Revocation List), with size and issuer name as recorded, from the LDAP server whose address and port are recorded in the Source field.
Failed to decode the received ca cert	The router received a corrupted certification authority certificate from the LDAP server whose address and port are recorded in the Source field.
Failed to decode the received user cert	The router received a corrupted user certificate from the LDAP server whose address and port are recorded in the Source field.
Failed to decode the received CRL	The router received a corrupted CRL (Certificate Revocation List) from the LDAP server whose address and port are recorded in the Source field.
Failed to decode the received ARL	The router received a corrupted ARL (Authority Revocation List) from the LDAP server whose address and port are recorded in the Source field.

Table 262 PKI Logs (continued)

LOG MESSAGE	DESCRIPTION
Rcvd data <size> too large! Max size allowed: <max size>	The router received directory data that was too large (the size is listed) from the LDAP server whose address and port are recorded in the Source field. The maximum size of directory data that the router allows is also recorded.
Cert trusted: <subject name>	The router has verified the path of the certificate with the listed subject name.
Due to <reason codes>, cert not trusted: <subject name>	Due to the reasons listed, the certificate with the listed subject name has not passed the path verification. The recorded reason codes are only approximate reasons for not trusting the certificate. Please see Table 263 on page 689 for the corresponding descriptions of the codes.

Table 263 Certificate Path Verification Failure Reason Codes

CODE	DESCRIPTION
1	Algorithm mismatch between the certificate and the search constraints.
2	Key usage mismatch between the certificate and the search constraints.
3	Certificate was not valid in the time interval.
4	(Not used)
5	Certificate is not valid.
6	Certificate signature was not verified correctly.
7	Certificate was revoked by a CRL.
8	Certificate was not added to the cache.
9	Certificate decoding failed.
10	Certificate was not found (anywhere).
11	Certificate chain looped (did not find trusted root).
12	Certificate contains critical extension that was not handled.
13	Certificate issuer was not valid (CA specific information missing).
14	(Not used)
15	CRL is too old.
16	CRL is not valid.
17	CRL signature was not verified correctly.
18	CRL was not found (anywhere).
19	CRL was not added to the cache.
20	CRL decoding failed.
21	CRL is not currently valid, but in the future.
22	CRL contains duplicate serial numbers.
23	Time interval is not continuous.
24	Time information not available.
25	Database method failed due to timeout.

Table 263 Certificate Path Verification Failure Reason Codes (continued)

CODE	DESCRIPTION
26	Database method failed.
27	Path was not verified.
28	Maximum path length reached.

Table 264 802.1X Logs

LOG MESSAGE	DESCRIPTION
Local User Database accepts user.	A user was authenticated by the local user database.
Local User Database reports user credential error.	A user was not authenticated by the local user database because of an incorrect user password.
Local User Database does not find user's credential.	A user was not authenticated by the local user database because the user is not listed in the local user database.
RADIUS accepts user.	A user was authenticated by the RADIUS Server.
RADIUS rejects user. Pls check RADIUS Server.	A user was not authenticated by the RADIUS Server. Please check the RADIUS Server.
Local User Database does not support authentication method.	The local user database only supports the EAP-MD5 method. A user tried to use another authentication method and was not authenticated.
User logout because of session timeout expired.	The router logged out a user whose session expired.
User logout because of user deassociation.	The router logged out a user who ended the session.
User logout because of no authentication response from user.	The router logged out a user from which there was no authentication response.
User logout because of idle timeout expired.	The router logged out a user whose idle timeout period expired.
User logout because of user request.	A user logged out.
Local User Database does not support authentication method.	A user tried to use an authentication method that the local user database does not support (it only supports EAP-MD5).
No response from RADIUS. Pls check RADIUS Server.	There is no response message from the RADIUS server, please check the RADIUS server.
Use Local User Database to authenticate user.	The local user database is operating as the authentication server.
Use RADIUS to authenticate user.	The RADIUS server is operating as the authentication server.
No Server to authenticate user.	There is no authentication server to authenticate a user.
Local User Database does not find user's credential.	A user was not authenticated by the local user database because the user is not listed in the local user database.

Table 265 ACL Setting Notes

PACKET DIRECTION	DIRECTION	DESCRIPTION
(L to W)	LAN to WAN	ACL set for packets traveling from the LAN to the WAN.
(W to L)	WAN to LAN	ACL set for packets traveling from the WAN to the LAN.
(D to L)	DMZ to LAN	ACL set for packets traveling from the DMZ to the LAN.
(D to W)	DMZ to WAN	ACL set for packets traveling from the DMZ to the WAN.
(W to D)	WAN to DMZ	ACL set for packets traveling from the WAN to the DMZ.
(L to D)	LAN to DMZ	ACL set for packets traveling from the LAN to the DMZ.
(L to L/ZW)	LAN to LAN/ ZyWALL	ACL set for packets traveling from the LAN to the LAN or the ZyWALL.
(W to W/ZW)	WAN to WAN/ ZyWALL	ACL set for packets traveling from the WAN to the WAN or the ZyWALL.
(D to D/ZW)	DMZ to DMZ/ ZyWALL	ACL set for packets traveling from the DMZ to the DM or the ZyWALL.

Table 266 ICMP Notes

TYPE	CODE	DESCRIPTION
0		Echo Reply
	0	Echo reply message
3		Destination Unreachable
	0	Net unreachable
	1	Host unreachable
	2	Protocol unreachable
	3	Port unreachable
	4	A packet that needed fragmentation was dropped because it was set to Don't Fragment (DF)
	5	Source route failed
4		Source Quench
	0	A gateway may discard internet datagrams if it does not have the buffer space needed to queue the datagrams for output to the next network on the route to the destination network.
5		Redirect
	0	Redirect datagrams for the Network
	1	Redirect datagrams for the Host
	2	Redirect datagrams for the Type of Service and Network
	3	Redirect datagrams for the Type of Service and Host
8		Echo
	0	Echo message

Table 266 ICMP Notes (continued)

TYPE	CODE	DESCRIPTION
11		Time Exceeded
	0	Time to live exceeded in transit
	1	Fragment reassembly time exceeded
12		Parameter Problem
	0	Pointer indicates the error
13		Timestamp
	0	Timestamp request message
14		Timestamp Reply
	0	Timestamp reply message
15		Information Request
	0	Information request message
16		Information Reply
	0	Information reply message

Syslog Logs

There are two types of syslog: event logs and traffic logs. The device generates an event log when a system event occurs, for example, when a user logs in or the device is under attack. The device generates a traffic log when a "session" is terminated. A traffic log summarizes the session's type, when it started and stopped the amount of traffic that was sent and received and so on. An external log analyzer can reconstruct and analyze the traffic flowing through the device after collecting the traffic logs.

Table 267 Syslog Logs

LOG MESSAGE	DESCRIPTION
Event Log: <Facility*8 + Severity>Mon dd hr:mm:ss hostname src="<srcIP:srcPort>" dst="<dstIP:dstPort>" msg="<msg>" note="<note>" devID="<mac address>" cat="<category>"	This message is sent by the system ("RAS" displays as the system name if you haven't configured one) when the router generates a syslog. The facility is defined in the Log Settings screen. The severity is the log's syslog class. The definition of messages and notes are defined in the various log charts throughout this appendix. The "devID" is the MAC address of the router's LAN port. The "cat" is the same as the category in the router's logs.
Traffic Log: <Facility*8 + Severity>Mon dd hr:mm:ss hostname src="<srcIP:srcPort>" dst="<dstIP:dstPort>" msg="Traffic Log" note="Traffic Log" devID="<mac address>" cat="Traffic Log" duration=seconds sent=sentBytes rcvd=receiveBytes dir="<from:to>" protoID=IPProtocolID proto="serviceName" trans="IPSec/ Normal"	This message is sent by the device when the connection (session) is closed. The facility is defined in the Log Settings screen. The severity is the traffic log type. The message and note always display "Traffic Log". The "proto" field lists the service name. The "dir" field lists the incoming and outgoing interfaces ("LAN:LAN", "LAN:WAN", "LAN:DMZ", "LAN:DEV" for example).

The following table shows RFC-2408 ISAKMP payload types that the log displays. Please refer to the RFC for detailed information on each type.

Table 268 RFC-2408 ISAKMP Payload Types

LOG DISPLAY	PAYLOAD TYPE
SA	Security Association
PROP	Proposal
TRANS	Transform
KE	Key Exchange
ID	Identification
CER	Certificate
CER_REQ	Certificate Request
HASH	Hash
SIG	Signature
NONCE	Nonce
NOTFY	Notification
DEL	Delete
VID	Vendor ID

Log Commands

Go to the command interpreter interface. [Appendix L on page 657](#) explains how to access and use the commands.

Configuring What You Want the ZyWALL to Log

- 1 Use the `sys logs load` command to load the log setting buffer that allows you to configure which logs the ZyWALL is to record.
- 2 Use `sys logs category` to view a list of the log categories.

Figure 431 Displaying Log Categories Example

```

ras> sys logs category
8021x          access          attack          display
error          icmp            ike             ipsec
javablocked   mten            packetfilter   ppp
cdr            pki             tls             remote
tcpreset      traffic         upnp            urlblocked
urlforward    wireless

```

- 3 Use `sys logs category` followed by a log category to display the parameters that are available for the category.

Figure 432 Displaying Log Parameters Example

```
ras> sys logs category access
Usage: [0:none/1:log/2:alert/3:both] [0:don't show debug type/
1:show debug type]
```

- 4 Use `sys logs category` followed by a log category and a parameter to decide what to record.

Use 0 to not record logs for that category, 1 to record only logs for that category, 2 to record only alerts for that category, and 3 to record both logs and alerts for that category. Not every parameter is available with every category.

- 5 Use the `sys logs save` command to store the settings in the ZyWALL (you must do this in order to record logs).

Displaying Logs

- Use the `sys logs display` command to show all of the logs in the ZyWALL's log.
- Use the `sys logs category display` command to show the log settings for all of the log categories.
- Use the `sys logs display [log category]` command to show the logs in an individual ZyWALL log category.
- Use the `sys logs clear` command to erase all of the ZyWALL's logs.

Log Command Example

This example shows how to set the ZyWALL to record the access logs and alerts and then view the results.

```

ras> sys logs load
ras> sys logs category access 3
ras> sys logs save
ras> sys logs display access

```

#	.time	source	destination	notes
	message			
	0 06/08/2004 05:58:21	172.21.4.154	224.0.1.24	ACCESS
	BLOCK			
		Firewall default policy: IGMP (W to W/ZW)		
	1 06/08/2004 05:58:20	172.21.3.56	239.255.255.250	ACCESS
	BLOCK			
		Firewall default policy: IGMP (W to W/ZW)		
	2 06/08/2004 05:58:20	172.21.0.2	239.255.255.254	ACCESS
	BLOCK			
		Firewall default policy: IGMP (W to W/ZW)		
	3 06/08/2004 05:58:20	172.21.3.191	224.0.1.22	ACCESS
	BLOCK			
		Firewall default policy: IGMP (W to W/ZW)		
	4 06/08/2004 05:58:20	172.21.0.254	224.0.0.1	ACCESS
	BLOCK			
		Firewall default policy: IGMP (W to W/ZW)		
	5 06/08/2004 05:58:20	172.21.4.187:137	172.21.255.255:137	ACCESS
	BLOCK			
		Firewall default policy: UDP (W to W/ZW)		

Index

Numerics

10/100 Mbps Ethernet WAN [50](#)
 110V AC [5](#)
 230V AC [5](#)

A

Abnormal Working Conditions [6](#)
 AC [5](#)
 Access Point [446](#)
 Accessories [5](#)
 ACK Message [628](#)
 Action for Matched Packets [189](#)
 Active [434](#), [435](#), [462](#)
 Acts of God [6](#)
 Address Assignment [141](#), [142](#), [341](#)
 Advanced Encryption Standard (AES) [231](#)
 AES [231](#)
 AH [231](#), [235](#)
 Airflow [5](#)
 ALG [51](#), [630](#)
 Allocated Budget [434](#), [465](#)
 Alternative Subnet Mask Notation [597](#)
 American Wire Gauge [5](#)
 AP (access point) [611](#)
 Application Layer Gateway [51](#), [630](#)
 Application-level Firewalls [167](#)
 Applications [56](#)
 AT command [431](#), [432](#), [524](#)
 Attack Types [172](#)
 Authen [434](#), [465](#)
 Authentication [434](#), [464](#), [465](#), [617](#)
 Authentication Code [218](#)
 Authentication Header (AH) [231](#)
 Authentication Protocol [464](#)
 Authority [4](#)
 Auto-negotiating 10/100 Mbps Ethernet DMZ [49](#)
 auto-negotiation [49](#), [50](#)
 AWG [5](#)

B

Backup [410](#), [524](#)
 Backup WAN [50](#)
 Bandwidth Borrowing [329](#)
 Bandwidth Class [325](#)
 Bandwidth Filter [325](#), [336](#)
 Bandwidth Management [51](#), [325](#)
 Bandwidth Management Statistics [337](#)
 Bandwidth Manager Class Configuration [334](#)
 Bandwidth Manager Class Setup [332](#)
 Bandwidth Manager Monitor [338](#)
 Bandwidth Manager Summary [331](#)
 Basement [5](#)
 Blocking Time [198](#), [199](#), [200](#)
 Bridge Protocol Data Units (BPDUs) [104](#)
 Brute-force Attack, [171](#)
 BSS [609](#)
 Budget Management [541](#), [542](#)
 BYE Request [628](#)

C

CA [616](#)
 Cable Modem [168](#)
 Cables, Connecting [5](#)
 Call Back Delay [433](#)
 Call Control [541](#)
 Call History [542](#), [543](#)
 Call Scheduling [53](#), [559](#)

- Max Number of Schedule Sets [559](#)
- PPPoE [561](#)
- Precedence [559](#)

Call-Triggering Packet [519](#)
 CardBus slot [50](#)
 Central Network Management [54](#)
 certificate [248](#)
 Certificate Authority [616](#)
 Certifications [4](#)
 Changes or Modifications [4](#)
 Changing the Password [421](#)
 Channel [611](#)

- Interference [611](#)

- Channel ID [116](#), [446](#)
- CHAP [434](#), [465](#)
- Charge [6](#)
- Circuit [4](#)
- Class B [4](#)
- Client-server Protocol [628](#)
- Command Interpreter Mode [539](#)
- Command Line [525](#)
- Communications [4](#)
- Community [509](#)
- Compliance, FCC [4](#)
- Components [6](#)
- Condition [6](#)
- Configuration [71](#), [93](#)
- Configuration File
 - Backup [524](#)
- Connecting Cables [5](#)
- Connection ID/Name [466](#)
- Consequential Damages [6](#)
- Console Port [513](#), [514](#), [515](#)
 - Configuration File Upload [536](#)
 - File Backup [528](#)
 - File Upload [535](#)
 - Restoring Files [531](#)
- Contact Information [7](#)
- Contacting Customer Support [7](#)
- Content Filtering [52](#), [201](#)
 - Categories [201](#)
 - Customizing [211](#)
 - Days and Times [201](#)
 - Filter List [201](#)
 - Restrict Web Features [201](#)
- Copyright [3](#)
- Correcting Interference [4](#)
- Corrosive Liquids [5](#)
- Covers [5](#)
- CTS (Clear to Send) [612](#)
- Custom Ports
 - Creating/Editing [190](#)
- Customer Support [7](#)
- Default [412](#)
- Defective [6](#)
- Denial of Service [168](#), [169](#), [198](#), [493](#)
- Denial of Services
 - Thresholds [199](#)
- Denmark, Contact Information [7](#)
- DES [231](#)
- Destination Address [181](#)
- DHCP [71](#), [93](#), [96](#), [106](#), [350](#), [397](#), [443](#)
- DHCP (Dynamic Host Configuration Protocol) [55](#)
- DHCP Ethernet Setup [442](#)
- DHCP Table [71](#)
- Diagnostic [519](#)
- Dial Timeout [433](#)
- Diffie-Hellman Key Groups [242](#)
- Disclaimer [3](#)
- Discretion [6](#)
- DMZ
 - IP Alias [454](#)
 - IP Alias Setup [455](#)
 - Port Filter Setup [453](#)
 - Setup [453](#), [454](#)
 - TCP/IP Setup [454](#)
- DNS [373](#)
- DNS Server
 - For VPN Host [342](#)
- Domain Name [142](#), [307](#), [397](#), [514](#)
- DoS
 - Basics [169](#)
 - Types [170](#)
- DoS (Denial of Service) [52](#)
- Drop Timeout [433](#)
- DSL Modem [56](#), [463](#)
- DTR [158](#), [432](#)
- Dust [5](#)
- Dynamic DNS [350](#)
- Dynamic DNS Support [54](#)
- Dynamic WEP Key Exchange [618](#)
- DYNDNS Wildcard [342](#), [350](#)

D

- Dampness [5](#)
- Danger [5](#)
- Data Encryption Standard (DES) [231](#)
- DDNS
 - Configuration [425](#)
- DDNS Type [427](#)
- Dealer [4](#)

E

- EAP [109](#)
- EAP Authentication [615](#), [616](#)
- ECHO [307](#)
- Edit IP [434](#), [463](#)
- Electric Shock [5](#)
- Electrical Pipes [5](#)
- Enable Wildcard [427](#)

Enable Wireless LAN [116](#)
 Encapsulating Security Payload (ESP) [231](#)
 Encapsulation [450](#), [462](#), [466](#)
 Encryption [229](#), [619](#)
 Entering Information [417](#)
 Equal Value [6](#)
 ESP [231](#), [235](#)
 ESS [610](#)
 ESSID [446](#)
 Ethernet [75](#), [77](#)
 Ethernet Encapsulation [449](#), [462](#), [469](#)
 Europe [5](#)
 Exposure [5](#)
 Extended Service Set [610](#)
 Extended Service Set IDentification [116](#), [446](#)

F

Factory Default [430](#)
 Factory LAN Defaults [93](#)
 Failure [6](#)
 Fairness-based Scheduler [327](#)
 FCC [4](#)
 Compliance [4](#)
 Rules, Part 15 [4](#)
 FCC Rules [4](#)
 Federal Communications Commission [4](#)
 Filename Conventions [523](#)
 Filter [439](#), [468](#), [495](#)
 Applying [507](#)
 Configuration [495](#)
 Configuring [498](#)
 DMZ [507](#)
 Example [504](#)
 Generic Filter Rule [502](#)
 Generic Rule [503](#)
 NAT [506](#)
 Remote Node [508](#)
 Structure [496](#)
 Filters
 Executing a Filter Rule [496](#)
 IP Filter Logic Flow [501](#)
 Finger [307](#)
 Finland, Contact Information [7](#)
 Firewall [52](#)
 Access Methods [179](#)
 Activating [493](#)
 Address Type [189](#)
 Alerts [183](#)
 Connection Direction [181](#)
 Creating/Editing Rules [187](#)

 Custom Ports See Custom Ports [190](#)
 Firewall Vs Filters [177](#)
 Guidelines For Enhancing Security [177](#)
 Introduction [168](#)
 Policies [179](#)
 Rule Logic [180](#)
 Services [194](#)
 SMT Menus [493](#)
 Types [167](#)
 When To Use [178](#)
 Firewall Threshold [199](#)
 Firmware File
 Maintenance [523](#)
 Fitness [6](#)
 Flow Control [415](#)
 Fragmentation Threshold [612](#)
 Fragmentation threshold [612](#)
 France, Contact Information [7](#)
 FTP [307](#), [350](#), [353](#), [368](#), [525](#), [549](#)
 File Upload [534](#)
 GUI-based Clients [526](#)
 Restoring Files [529](#)
 FTP File Transfer [532](#)
 FTP Restrictions [353](#), [526](#), [549](#)
 FTP Server [55](#), [486](#)
 Full Network Management [55](#)
 Functionally Equivalent [6](#)
 Fuse
 Replacement [581](#)
 Type [575](#)

G

Gas Pipes [5](#)
 Gateway IP Addr [467](#)
 Gateway IP Address [450](#), [472](#)
 General Setup [397](#), [423](#)
 Germany, Contact Information [7](#)
 Global [297](#)
 God, act of [6](#)

H

Half-Open Sessions [198](#)
 Harmful Interference [4](#)
 Hidden Menus [417](#)
 Hidden node [611](#)
 High Voltage Points [5](#)

Host [399, 427](#)
Host IDs [595](#)
How SSH works [362](#)
How STP Works [104](#)
HTTP [167, 169, 307](#)
HTTPS [52, 354](#)
HTTPS Example [357](#)
HyperTerminal [536, 537](#)
HyperTerminal program [528, 531](#)

I

IBSS [609](#)
ICMP echo [171](#)
Idle Timeout [434, 435, 464, 465](#)
IEEE 802.11b [50](#)
IEEE 802.11g [613](#)
IEEE 802.1x [53](#)
IGMP [95](#)
IKE Phases [240](#)
Incoming Protocol Filters [445](#)
Independent Basic Service Set [609](#)
Indirect Damages [6](#)
Initial Screen [415](#)
initialization vector (IV) [619](#)
Inside [297](#)
Inside Global Address [297](#)
Inside Local Address [297](#)
Installing Fuses [581](#)
Insurance [6](#)
Interactive Applications [319](#)
Interference [4](#)
Interference Correction Measures [4](#)
Interference Statement [4](#)
Internet Access [75](#)
 ISP's Name [450](#)
Internet Access Setup [449, 450, 473](#)
Internet Control Message Protocol (ICMP) [171](#)
Internet Protocol Security (IPSec) [229](#)
Introduction to Filters [495](#)
IP Address [71, 94, 96, 106, 141, 142, 307, 309, 310, 443, 445, 450, 467, 480](#)
 Remote [436](#)
IP Address Assignment [450, 467](#)
IP Addressing [595](#)
IP Alias [54, 445](#)
IP Alias Setup [444](#)
IP Classes [595](#)

IP Multicast [54](#)
 Internet Group Management Protocol (IGMP) [54](#)
IP Policy Routing [54](#)
IP Pool [97, 443](#)
IP Pool Setup [93](#)
IP Ports [169](#)
IP Routing Policy (IPPR) [319](#)
 Benefits [319](#)
 Cost Savings [319](#)
 Criteria [319](#)
 Load Sharing [319](#)
IP Spoofing [170, 173](#)
IP Static Route [471, 472](#)
 Active [472](#)
 Destination IP Address [472](#)
 IP Subnet Mask [472](#)
 Name [472](#)
 Route Number [472](#)
IP Subnet Mask [436, 445](#)
 Remote [436](#)
IPSec [229](#)
IPSec algorithms [231](#)
IPSec and NAT [232](#)
IPSec architecture [231](#)
IPSec standard [51](#)
IPSec VPN Capability [51, 52](#)
ISP Parameters [75](#)
ISP's Name [450](#)

K

Key Fields For Configuring Rules [181](#)

L

Labor [6](#)
LAN IP Address [393, 395](#)
LAN Port Filter Setup [441](#)
LAN Setup [441, 442](#)
LAN TCP/IP [93](#)
LAN to WAN Rules [182](#)
LAND [170, 171](#)
Legal Rights [6](#)
Liability [3](#)
License [3](#)
Lightning [5](#)
Link type [64, 65, 107](#)
Liquids, Corrosive [5](#)

Local [297](#)
 Log [515](#)
 Log Facility [517](#)
 Logging [55](#)
 Login Name [450](#)
 Login Screen [416](#)

M

MAC Address [430](#)
 MAC Address Filter Action [448](#)
 MAC Address Filtering [127](#)
 MAC service data unit [447](#)
 Main Menu [417](#)
 Main Menu Commands [416](#)
 Management Information Base (MIB) [370](#)
 Many to Many No Overload [300](#)
 Many to Many Overload [300](#)
 Many to One [300](#)
 Materials [6](#)
 Max Age [105](#)
 Maximize Bandwidth Usage [327](#), [332](#)
 Maximum Incomplete High [200](#)
 Maximum Incomplete Low [200](#)
 Max-incomplete High [198](#)
 Max-incomplete Low [198](#), [200](#)
 Mean Time Between Failures [575](#)
 Merchantability [6](#)
 Message Integrity Check (MIC) [619](#)
 Metric [135](#), [317](#), [437](#), [464](#), [468](#), [472](#)
 Modifications [4](#)
 MSDU [447](#)
 Multicast [95](#), [97](#), [437](#), [444](#), [468](#)
 Multimedia [196](#), [627](#)
 My IP Addr [466](#)
 My Login [434](#), [462](#)
 My Login Name [450](#)
 My Password [434](#), [450](#), [462](#)
 My Server IP Addr [466](#)
 My WAN Address [436](#)
 myZyXEL.com [217](#)
 device registration [220](#)

N

Nailed-Up Connection [465](#)

Nailed-up Connection [464](#)
 Nailed-Up Connections [466](#)
 NAT [94](#), [307](#), [308](#), [436](#), [437](#), [467](#), [468](#), [506](#)
 Application [299](#)
 Applying NAT in the SMT Menus [473](#)
 Configuring [475](#)
 Definitions [297](#)
 Examples [483](#)
 How NAT Works [298](#)
 Mapping Types [300](#)
 NAT Unfriendly Application Programs [489](#)
 Ordering Rules [478](#)
 Port Restricted Cone [300](#)
 What NAT does [298](#)
 NAT Routers [630](#)
 NAT Traversal [377](#), [379](#)
 NAT traversal [237](#)
 Navigation Panel [66](#)
 Negotiation Mode [241](#)
 NetBIOS commands [172](#)
 Network Address Translation [450](#)
 Network Address Translation (NAT) [54](#)
 Network Address Translators [630](#)
 Network Management [307](#)
 New [6](#)
 NNTP [307](#)
 North America [5](#)
 North America Contact Information [7](#)
 Norway, Contact Information [7](#)

O

Offline [427](#)
 OK Response [628](#)
 One Minute High [200](#)
 One Minute Low [199](#)
 One to One [300](#)
 One-Minute High [198](#)
 Opening [5](#)
 Operating Condition [6](#)
 Out-dated Warranty [6](#)
 Outgoing Protocol Filters [445](#)
 Outlet [4](#)
 Outside [297](#)

P

Packet Filtering [53](#), [177](#)

Packet Filtering Firewalls [167](#)
Pairwise Master Key (PMK) [619](#)
PAP [434](#), [465](#)
Parts [6](#)
Password [398](#), [416](#), [421](#), [450](#), [509](#)
Patent [3](#)
Path cost [104](#)
PCMCIA Port [50](#)
Perfect Forward Secrecy [242](#)
Period(hr) [434](#), [465](#)
Permission [3](#)
Photocopying [3](#)
Ping [521](#)
Ping of Death [170](#)
Pipes [5](#)
Point-to-Point Tunneling Protocol [78](#), [307](#)
Point-to-Point Tunneling Protocol See PPTP [150](#)
Policy-based Routing [319](#)
Pool [5](#)
POP3 [169](#), [307](#)
Port Forwarding [55](#)
Port Restricted Cone NAT [300](#)
Postage Prepaid. [6](#)
Power Cord [5](#)
PPP [435](#)
PPPoE [53](#), [75](#), [77](#), [603](#)
PPPoE Encapsulation [449](#), [452](#), [462](#), [463](#), [464](#), [465](#), [469](#)
PPTP [75](#), [78](#), [147](#), [150](#), [307](#)
 Client [451](#)
 Configuring a Client [451](#)
PPTP Encapsulation [53](#), [78](#)
Preamble Mode [613](#)
Precedence [319](#)
Pre-Shared Key [241](#), [248](#)
Priority-based Scheduler [327](#)
Private [317](#), [437](#), [468](#), [472](#)
Private IP Address [141](#)
Product Model [7](#)
Product Page [4](#)
Product Serial Number [7](#)
Products [6](#)
Proof of Purchase [6](#)
Proper Operating Condition [6](#)
Proportional Bandwidth Allocation [326](#)
Protocol Filters [445](#)
 Incoming [445](#)
 Outgoing [445](#)
Protocol/Port [393](#), [394](#)
Purchase, Proof of [6](#)
Purchaser [6](#)

Q

Qualified Service Personnel [5](#)
Quality of Service [319](#)
Quick Start Guide [59](#)

R

Radio Communications [4](#)
Radio Frequency Energy [4](#)
Radio Interference [4](#)
Radio Reception [4](#)
Radio Technician [4](#)
RADIUS [52](#), [614](#)
 Shared Secret Key [615](#)
RADIUS Message Types [614](#)
RADIUS Messages [614](#)
Rapid STP [104](#)
RAS [320](#)
Read Me First [47](#)
Real Time Chip [50](#)
Real time Transport Protocol [630](#)
Receiving Antenna [4](#)
Registered [3](#)
Registered Trademark [3](#)
Regular Mail [7](#)
Related Documentation [47](#)
Relay [443](#)
Relocate [4](#)
Rem IP Address [436](#)
Rem Node Name [434](#), [435](#), [462](#)
Re-manufactured [6](#)
Remote Authentication Dial In User Service See
 RADIUS [52](#)
Remote Management [547](#)
Remote Management and NAT [354](#)
Remote Management Limitations [353](#)
Remote Node [461](#)
Remote Node Filter [439](#), [468](#)
Removing [5](#)
Removing and Installing Fuses [581](#)
Reorient [4](#)
Repair [6](#)
Replace [6](#)
Replacement [6](#)
Reports [392](#)
Reproduction [3](#)
Required fields [417](#)

- Reset Button [50](#)
- Resetting the Time [402, 546](#)
- Resetting the ZyWALL [60](#)
- Restore [6, 410](#)
- Restore Configuration [529](#)
- retry count [433](#)
- retry interval [433](#)
- Return Material Authorization (RMA) Number [6](#)
- Returned Products [6](#)
- Returns [6](#)
- RFC 1889 [630](#)
- RFC 3489 [630](#)
- Rights [3](#)
- Rights, Legal [6](#)
- RIP [94, 95, 437, 444, 445, 468](#)
 - Direction [445](#)
 - Version [445, 468](#)
- Risk [5](#)
- Risks [5](#)
- RMA [6](#)
- RoadRunner Support [55](#)
- Roaming [620](#)
 - Example [621](#)
 - Requirements [622](#)
- Root bridge [104](#)
- Root Class [332](#)
- Route [463](#)
- Routing Policy [319](#)
- RTC [543](#)
- RTC See Real Time Chip [50](#)
- RTP [630](#)
- RTS (Request To Send) [612](#)
- RTS (Request To Send) threshold [116](#)
- RTS Threshold [611, 612](#)
- RTS/CTS handshake [447](#)
- Rules [179, 182](#)
 - Checklist [180](#)
 - Creating Custom [179](#)
 - Key Fields [181](#)
 - LAN to WAN [182](#)
 - Logic [180](#)
- Scheduler [327, 332](#)
- Schedules [465, 466](#)
- Secure FTP Using SSH Example [366](#)
- Secure Telnet Using SSH Example [365](#)
- Security Parameters [620](#)
- Security Ramifications [181](#)
- Separation Between Equipment and Receiver [4](#)
- Serial Number [7, 218](#)
- Server [301, 401, 402, 450, 463, 475, 477, 480, 481, 483, 485, 486, 545](#)
- Server IP [463](#)
- Service [5, 6, 181](#)
- Service Name [465](#)
- Service Personnel [5](#)
- Service Set [116](#)
- Service Type [190, 450, 462](#)
- Services [307](#)
- Session Initiation Protocol [196, 627](#)
- Set Up a Schedule [559](#)
- Shipping [6](#)
- Shock, Electric [5](#)
- SIP Account [627](#)
- SIP ALG [630](#)
- SIP Application Layer Gateway [51, 630](#)
- SIP Client [628](#)
- SIP INVITE Request [628](#)
- SIP Redirect Server [629](#)
- SIP Register Server [630](#)
- SIP Servers [628](#)
- SIP URI [627](#)
- SIP User Agent Server [628](#)
- SMT [416](#)
- SMT Menu Overview [419](#)
- SMTP [307](#)
- Smurf [171, 172](#)
- SNMP [54, 307, 369](#)
 - Community [509](#)
 - Configuration [509](#)
 - Get [370](#)
 - Manager [370](#)
 - MIBs [371](#)
 - Trap [370](#)
 - Trusted Host [509](#)
- SNMP (Simple Network Management Protocol) [54](#)
- Source Address [181, 189](#)
- Source-Based Routing [319](#)
- Spain, Contact Information [7](#)
- Spanning Tree Protocol [103](#)
- SSH [52, 362](#)
- SSH Implementation [363](#)
- Stateful Inspection [52, 167, 168, 173, 174](#)

S

- SA (Security Association) [229](#)
- Safety Warnings [5](#)
- Saving the State [173](#)
- Schedule Sets
 - Duration [560](#)

Process [174](#)
ZyWALL [175](#)
Static Route [315](#)
STP (Spanning Tree Protocol) [51](#)
STP Port States [105](#)
STP See Spanning Tree Protocol [103](#)
STP Terminology [104](#)
SUA (Single User Account) [301](#), [473](#)
Sub-class Layers [332](#)
Subnet Mask [94](#), [96](#), [106](#), [189](#), [436](#), [443](#), [450](#), [467](#), [472](#)
Subnet Masks [596](#)
Subnetting [596](#)
Supply Voltage [5](#)
Support E-mail [7](#)
Supporting Disk [47](#)
Sweden, Contact Information [7](#)
Swimming Pool [5](#)
SYN Flood [170](#), [171](#)
SYN-ACK [170](#)
Syntax Conventions [48](#)
Syslog [190](#), [194](#)
Syslog IP Address [516](#)
System Information [511](#), [513](#)
System Maintenance [511](#), [512](#), [513](#), [514](#), [515](#), [516](#), [520](#),
[521](#), [524](#), [527](#), [535](#), [536](#), [539](#), [541](#), [542](#), [544](#), [545](#)
System Management Terminal [416](#)
System Name [398](#), [423](#)
System Statistics [69](#)
System Status [511](#)
System Timeout [354](#)

T

Tampering [6](#)
TCP Maximum Incomplete [198](#), [199](#), [200](#)
TCP Security [175](#)
TCP/IP [169](#), [170](#), [367](#), [435](#), [442](#), [443](#), [454](#), [466](#), [500](#),
[501](#), [503](#), [506](#)
Setup [443](#)
TCP/IP and DHCP Setup [442](#)
TCP/IP filter rule [500](#)
Teardrop [170](#)
Telecommunication Line Cord. [5](#)
Telephone [7](#)
Television Interference [4](#)
Television Reception [4](#)
Telnet [367](#)
Telnet Configuration [367](#)

Temporal Key Integrity Protocol (TKIP) [619](#)
Terminal Emulation [415](#)
TFTP [527](#)
File Upload [534](#)
GUI-based Clients [528](#)
TFTP and FTP over WAN [526](#)
TFTP Restrictions [353](#), [526](#), [549](#)
Three-Way Handshake [170](#)
Threshold Values [198](#)
Thunderstorm [5](#)
Time and Date [50](#)
Time and Date Setting [543](#), [544](#)
Time Zone [400](#), [546](#)
Timeout [434](#), [435](#), [451](#), [452](#), [465](#)
ToS (Type of Service) [319](#)
Trace [515](#)
Traceroute [173](#)
Tracing [55](#)
Trademark [3](#)
Trademark Owners [3](#)
Trademarks [3](#)
Traffic Redirect [55](#), [153](#)
Translation [3](#)
Transport mode [232](#)
Trigger Port Forwarding [491](#)
Trivial File Transfer Protocol [527](#)
Tunnel mode [232](#)
TV Technician [4](#)
Type of Service [319](#)

U

UDP/ICMP Security [176](#)
Undesired Operations [4](#)
Uniform Resource Identifier [627](#)
Universal Plug and Play (UPnP) [377](#), [379](#)
UNIX Syslog [516](#)
Upload Firmware [532](#)
UPnP [52](#), [377](#)
UPnP Examples [380](#)
UPnP Port Mapping [379](#)
Upper Layer Protocols [175](#), [176](#)
Use Server Detected IP [428](#)
User Authentication [619](#)
User Name [425](#)
User Profiles [293](#)

V

Value [6](#)
Vendor [5](#)
Ventilation Slots [5](#)
Viewing Certifications [4](#)
Virtual Private Network [51](#)
Voltage Supply [5](#)
Voltage, High [5](#)
VPN [150](#)
 encapsulation [231](#)
 keep alive [237](#)
 key management [231](#)
 secure gateway [236](#)
VPN Application [56, 230](#)
VPN Status [72](#)
VT100 [415](#)

W

Wall Mount [5](#)
WAN DHCP [520, 521](#)
WAN Setup [142, 429](#)
WAN to LAN Rules [182](#)
Warnings [5](#)
Warranty [6](#)
Warranty Information [7](#)
Warranty Period [6](#)
Water [5](#)
Water Pipes [5](#)
Web [367](#)
Web Configurator [59, 62, 168, 177, 181, 494](#)
Web Site [7](#)
Web Site Hits [393, 394](#)
WEP Encryption [53, 118, 123, 126](#)
WEP encryption [617](#)
Wet Basement [5](#)
Wireless LAN [50](#)
Wireless LAN MAC Address Filtering [53](#)
Wireless LAN Setup [445](#)
Wizard Setup [75](#)
WLAN
 Interference [611](#)
 Security parameters [620](#)
Workmanship [6](#)
Worldwide Contact Information [7](#)
Written Permission [3](#)
WWW [355](#)

www.dyndns.org [427](#)

X

Xmodem
 File Upload [536](#)
XMODEM Protocol [524](#)

Z

ZyNOS [3, 514, 524](#)
ZyNOS F/W Version [514, 524](#)
ZyXEL Communications Corporation [3](#)
ZyXEL Home Page [4](#)
ZyXEL Limited Warranty
 Note [6](#)
ZyXEL Network Operating System [3](#)
ZyXEL's Firewall
 Introduction [168](#)
ZyXEL's online services center [217](#)