

# *PoE-80*

*Eight-port Power over Ethernet Hub*

## *User's Guide*

Version 1.06  
April 2004



# Table of Contents

Copyright .....	3
Federal Communications Commission (FCC) Interference Statement .....	3
Information for Canadian Users .....	4
ZyXEL Limited Warranty .....	5
Syntax Conventions in this Guide .....	6
Customer Support .....	6
1 About Your PoE-80 .....	9
1.1 Key Features .....	9
1.2 Packaging List .....	9
2 Hardware and Installation .....	10
2.1 Desktop Installation .....	10
2.2 Rack-mounted Installation .....	10
2.3 Rear Panel Connections .....	11
2.4 Front Panel Connections .....	12
2.5 Front Panel LEDs .....	12
3 Software Utility Installation .....	12
3.1 Starting the Utility .....	15
4 Removing the Utility .....	15
5 Managing the PoE-80 .....	17
5.1 System Setup & Control .....	17
5.2 System Information .....	18
5.3 Port Specific Control .....	19
5.4 Parametric Information .....	21
6 Troubleshooting .....	21
7 Specifications .....	22
7.1 DATA OUT PoE Injector RJ-45 Port Pin Assignments .....	23

# Copyright

## **Copyright © 2004 by ZyXEL Communications Corporation.**

The contents of this publication may not be reproduced in any part or as a whole, transcribed, stored in a retrieval system, translated into any language, or transmitted in any form or by any means, electronic, mechanical, magnetic, optical, chemical, photocopying, manual, or otherwise, without the prior written permission of ZyXEL Communications Corporation.

Published by ZyXEL Communications Corporation. All rights reserved.

## **Disclaimer**

ZyXEL does not assume any liability arising out of the application or use of any products, or software described herein. Neither does it convey any license under its patent rights nor the patent rights of others. ZyXEL further reserves the right to make changes in any products described herein without notice.

This publication is subject to change without notice.

## **Trademarks**

Trademarks mentioned in this publication are used for identification purposes only and may be properties of their respective owners.

# Federal Communications Commission (FCC) Interference Statement

This device complies with Part 15 of FCC rules. Operation is subject to the following two conditions:

This device may not cause harmful interference.

This device must accept any interference received, including interference that may cause undesired operations.

This equipment has been tested and found to comply with the limits for a CLASS B digital device pursuant to Part 15 of the FCC Rules. These limits are designed to provide reasonable protection against harmful interference in a commercial environment. This equipment generates, uses, and can radiate radio frequency energy, and if not installed and used in accordance with the instructions, may cause harmful interference to radio communications.

If this equipment does cause harmful interference to radio/television reception, which can be determined by turning the equipment off and on, the user is encouraged to try to correct the interference by one or more of the following measures:

Reorient or relocate the receiving antenna.

Increase the separation between the equipment and the receiver.

Connect the equipment into an outlet on a circuit different from that to which the receiver is connected.

Consult the dealer or an experienced radio/TV technician for help.

## Notice 1

Changes or modifications not expressly approved by the party responsible for compliance could void the user's authority to operate the equipment.

## Certifications

1. Go to [www.zyxel.com](http://www.zyxel.com).
2. Select your product from the drop-down list box on the ZyXEL home page to go to that product's page.
3. Select the certification you wish to view from this page.

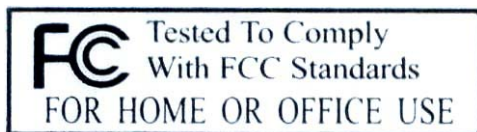

## Information for Canadian Users

The Industry Canada label identifies certified equipment. This certification means that the equipment meets certain telecommunications network protective, operation, and safety requirements. The Industry Canada does not guarantee that the equipment will operate to a user's satisfaction.

Before installing this equipment, users should ensure that it is permissible to be connected to the facilities of the local telecommunications company. The equipment must also be installed using an acceptable method of connection. In some cases, the company's inside wiring associated with a single line individual service may be extended by means of a certified connector assembly. The customer should be aware that the compliance with the above conditions may not prevent degradation of service in some situations.

Repairs to certified equipment should be made by an authorized Canadian maintenance facility designated by the supplier. Any repairs or alterations made by the user to this equipment, or equipment malfunctions, may give the telecommunications company cause to request the user to disconnect the equipment.

For their own protection, users should ensure that the electrical ground connections of the power utility, telephone lines, and internal metallic water pipe system, if present, are connected together. This precaution may be particularly important in rural areas.

## **Caution**

Users should not attempt to make such connections themselves, but should contact the appropriate electrical inspection authority, or electrician, as appropriate.

## **Note**

This digital apparatus does not exceed the class A limits for radio noise emissions from digital apparatus set out in the radio interference regulations of Industry Canada.

# **ZyXEL Limited Warranty**

ZyXEL warrants to the original end user (purchaser) that this product is free from any defects in materials or workmanship for a period of up to two years from the date of purchase. During the warranty period, and upon proof of purchase, should the product have indications of failure due to faulty workmanship and/or materials, ZyXEL will, at its discretion, repair or replace the defective products or components without charge for either parts or labor, and to whatever extent it shall deem necessary to restore the product or components to proper operating condition. Any replacement will consist of a new or re-manufactured functionally equivalent product of equal value, and will be solely at the discretion of ZyXEL. This warranty shall not apply if the product is modified, misused, tampered with, damaged by an act of God, or subjected to abnormal working conditions.

## **NOTE**

Repair or replacement, as provided under this warranty, is the exclusive remedy of the purchaser. This warranty is in lieu of all other warranties, express or implied, including any implied warranty of merchantability or fitness for a particular use or purpose. ZyXEL shall in no event be held liable for indirect or consequential damages of any kind of character to the purchaser.

To obtain the services of this warranty, contact ZyXEL's Service Center for your Return Material Authorization number (RMA). Products must be returned Postage Prepaid. It is recommended that the unit be insured when shipped. Any returned products without proof of purchase or those with an out-dated warranty will be repaired or replaced (at the discretion of ZyXEL) and the customer will be billed for parts and labor. All repaired or replaced products will be shipped by ZyXEL to the corresponding return address, Postage Paid. This warranty gives you specific legal rights, and you may also have other rights that vary from country to country.



## Online Registration

Register your product online to receive e-mail notices of firmware upgrades and information at [www.zyxel.com](http://www.zyxel.com) for global products, or at [www.us.zyxel.com](http://www.us.zyxel.com) for North American products.

# Syntax Conventions in this Guide

The PoE-80 Eight-port Power over Ethernet Hub may be called the “PoE-80”, “the power injector” or “the system” in this guide.

# Customer Support

When you contact your customer support representative please have the following information ready:

Please have the following information ready when you contact customer support (see the next page for contact information).

- Product model and serial number.
- Warranty Information.
- Date that you received your device.
- Brief description of the problem and the steps you took to solve it.

## PoE-80 User's Guide

METHOD LOCATION	SUPPORT E-MAIL SALES E-MAIL	TELEPHONE <sup>1</sup> FAX <sup>1</sup>	WEB SITE FTP SITE	REGULAR MAIL
WORLDWIDE	<a href="mailto:support@zyxel.com.tw">support@zyxel.com.tw</a>  <a href="mailto:sales@zyxel.com.tw">sales@zyxel.com.tw</a>	+886-3-578-3942  +886-3-578-2439	<a href="http://www.zyxel.com">www.zyxel.com</a> <a href="http://www.europe.zyxel.com">www.europe.zyxel.com</a> <a href="ftp://ftp.zyxel.com">ftp.zyxel.com</a> <a href="ftp://ftp.europe.zyxel.com">ftp.europe.zyxel.com</a>	ZyXEL Communications Corp. 6 Innovation Road II Science Park Hsinchu 300 Taiwan
NORTH AMERICA	<a href="mailto:support@zyxel.com">support@zyxel.com</a>  <a href="mailto:sales@zyxel.com">sales@zyxel.com</a>	+1-800-255-4101 +1-714-632-0882 +1-714-632-0858	<a href="http://www.us.zyxel.com">www.us.zyxel.com</a>  <a href="ftp://ftp.us.zyxel.com">ftp.us.zyxel.com</a>	ZyXEL Communications Inc. 1130 N. Miller St. Anaheim CA 92806-2001 U.S.A.
GERMANY	<a href="mailto:support@zyxel.de">support@zyxel.de</a>  <a href="mailto:sales@zyxel.de">sales@zyxel.de</a>	+49-2405-6909-0 +49-2405-6909-99	<a href="http://www.zyxel.de">www.zyxel.de</a>	ZyXEL Deutschland GmbH. Adenauerstr. 20/A2 D-52146 Wuerselen Germany
FRANCE	<a href="mailto:info@zyxel.fr">info@zyxel.fr</a>	+33 (0)4 72 52 97 97 +33 (0)4 72 52 19 20	<a href="http://www.zyxel.fr">www.zyxel.fr</a>	ZyXEL France 1 rue des Vergers Bat. 1 / C 69760 Limonest France
SPAIN	<a href="mailto:support@zyxel.es">support@zyxel.es</a>  <a href="mailto:sales@zyxel.es">sales@zyxel.es</a>	+34 902 195 420 +34 913 005 345	<a href="http://www.zyxel.es">www.zyxel.es</a>	ZyXEL Communications Alejandro Villegas 33 1º, 28043 Madrid Spain
DENMARK	<a href="mailto:support@zyxel.dk">support@zyxel.dk</a>  <a href="mailto:sales@zyxel.dk">sales@zyxel.dk</a>	+45 39 55 07 00 +45 39 55 07 07	<a href="http://www.zyxel.dk">www.zyxel.dk</a>	ZyXEL Communications A/S Columbusvej 5 2860 Soeborg Denmark
NORWAY	<a href="mailto:support@zyxel.no">support@zyxel.no</a>  <a href="mailto:sales@zyxel.no">sales@zyxel.no</a>	+47 22 80 61 80 +47 22 80 61 81	<a href="http://www.zyxel.no">www.zyxel.no</a>	ZyXEL Communications A/S Nils Hansens vei 13 0667 Oslo Norway
SWEDEN	<a href="mailto:support@zyxel.se">support@zyxel.se</a>  <a href="mailto:sales@zyxel.se">sales@zyxel.se</a>	+46 31 744 7700 +46 31 744 7701	<a href="http://www.zyxel.se">www.zyxel.se</a>	ZyXEL Communications A/S Sjöporten 4, 41764 Göteborg Sweden
FINLAND	<a href="mailto:support@zyxel.fi">support@zyxel.fi</a>  <a href="mailto:sales@zyxel.fi">sales@zyxel.fi</a>	+358-9-4780-8411 +358-9-4780 8448	<a href="http://www.zyxel.fi">www.zyxel.fi</a>	ZyXEL Communications Oy Malminkaari 10 00700 Helsinki Finland

<sup>1</sup> “+” is the (prefix) number you enter to make an international telephone call.





# 1 About Your PoE-80

The PoE-80 Eight-port Power over Ethernet Hub is an eight-port power injector, designed for use with 10/100 BaseT Ethernet networks. The PoE-80 injects DC power through the unused twisted-wires (pairs 4/5 and 7/8) of a standard 8-pin CAT 5 cable. This allows increased flexibility in the locating of power over Ethernet (PoE) enabled devices by eliminating the need for a nearby power source.

## 1.1 Key Features

- Eight RJ-45, 10/100 Mbps PoE-enabled ports
- Ensures a constant power supply to PoE-enabled devices.
- Automatically detects if connected devices are PoE-enabled to avoid sending power to non-PoE devices.
- Supports power management
- Control, status, and parameters manageable per port
- Remote power feeding up to 100 meters
- Centralized power distribution
- Protection against short circuits
- Accepts a wide range of AC power input
- Automatically updates management information.

## 1.2 Packaging List

The following items come with your PoE-80.

- This User's Guide
- One power cord
- One console cable
- One Ethernet cable
- Rack mount kit

## 2 Hardware and Installation

---

**Do not block the device's rear panel fans or the side panel ventilation holes. Leave space between devices when stacking.**

---

### 2.1 Desktop Installation

- Step 1.** Set the PoE-80 upside-down on a sturdy level space with a power outlet nearby.
- Step 2.** Make sure there is enough clearance around the PoE-80 to allow air circulation and the attachment of cables and the power cord.
- Step 3.** Remove the adhesive backing from the supplied rubber feet.
- Step 4.** Attach the rubber feet to each corner on the bottom of the PoE-80. These rubber feet help protect the PoE-80 from shock or vibration and ensure space between devices when stacking.



- Step 5.** Turn the PoE-80 right-side up after you attach the rubber feet.

### 2.2 Rack-mounted Installation

The PoE-80 can be mounted on an EIA standard size, 19-inch rack or in a wiring closet with other equipment. Follow the steps below to mount your PoE-80 on a standard EIA rack using the included rack-mounting kit.

- Step 1.** Align one bracket with the holes on one side of the PoE-80 and secure it with the bracket screws. Similarly, attach the other bracket.



**Step 2.** After attaching both mounting brackets, position the PoE-80 in the rack by lining up the holes in the brackets with the appropriate holes on the rack. Secure the PoE-80 to the rack with the rack's mounting screws.



## 2.3 Rear Panel Connections



Connect the female end of the power cord to the power receptacle. Connect the male end to a 100-240V AC, 50-60 Hz power source (wall outlet). Push the power switch to the **ON** position.

## 2.4 Front Panel Connections



The **DATA OUT** ports send power and data to the PoE-enabled devices. Use Ethernet cables to connect the eight **DATA OUT** RJ-45 Ethernet ports to PoE-enabled devices.

Use Ethernet cables to connect the eight **DATA IN** RJ-45 Ethernet ports to the LAN.

---

**The maximum Ethernet cable length is 100m.**

---

Use a console cable to connect the console port to a management computer.

## 2.5 Front Panel LEDs

The LEDs give real-time information about the system's operational status.

LED	COLOR	STATUS	MEANING
PWR	Green	On Off	Power is being supplied to the PoE-80. No power is being supplied to the PoE-80.
PWR FWD	Green	On Off	The <b>DATA OUT</b> port is connected and sending power to an Ethernet device. The <b>DATA OUT</b> port is not sending power to an Ethernet device.
PWR OFF	Orange	On Off	The Ethernet device connected to the PoE-80's <b>DATA OUT</b> port requires more power than the PoE-80 can provide or the Ethernet cable is shorted. The connection to the Ethernet device is functioning properly or no Ethernet device is connected to the <b>DATA OUT</b> port.

## 3 Software Utility Installation

Install the software utility in order to configure the PoE-80 PD. You can easily view the PoE-80's power parameters and control it through the software utility. The software utility provides an easy-to-use GUI interface. The software utility is compatible with Windows 2000 and XP. Please follow the below steps to install the software utility. You may need to use your Windows CD during the installation.

- Step 1.** Insert the included CD-ROM into your CD-ROM drive.
- Step 2.** Run (browse to and double-click) setup.exe.
- Step 3.** The installation screen displays. Click **OK** to go to the next step.



- Step 4.** Click the icon button to start the installation.



- Step 5.** Choose a group name (you can use the default) and click **Continue**.

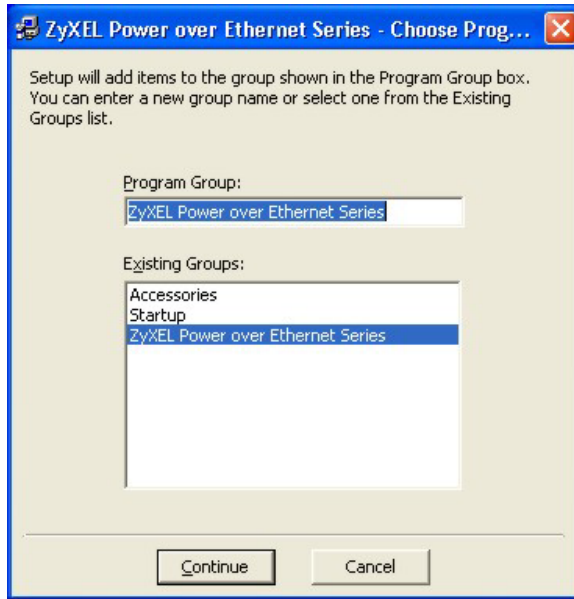

**Step 6.** Click **Yes** if the **Version Conflict** screen displays.

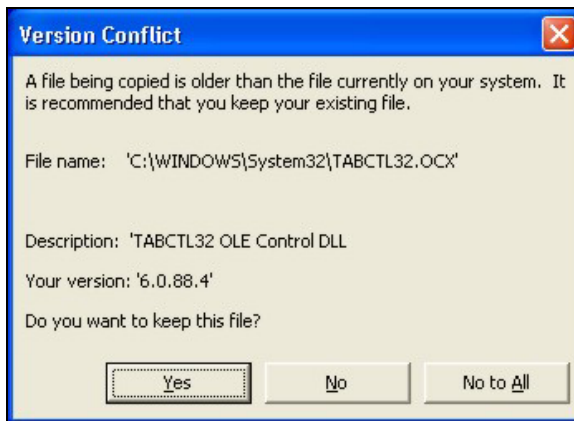

**Step 7.** When installation finishes, click **OK** to finish.



### 3.1 Starting the Utility

Click **Start, Programs, ZyXEL Power over Ethernet Series** and then **ZyXEL Power over Ethernet Series** to run the software utility.

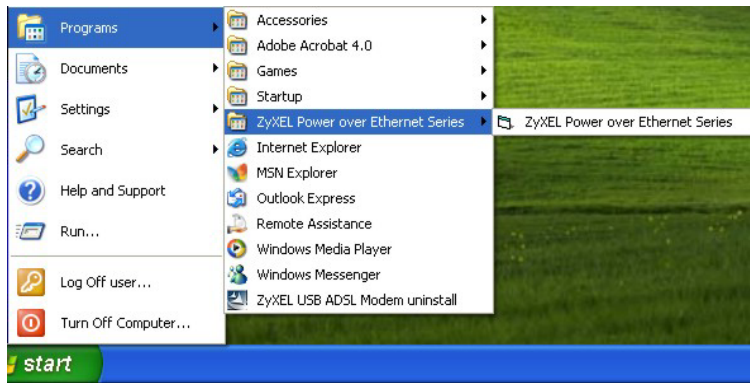

## 4 Removing the Utility

Use the following procedure to remove the software utility from your computer.

**Step 1.** Click **Start, Settings, Control Panel**.

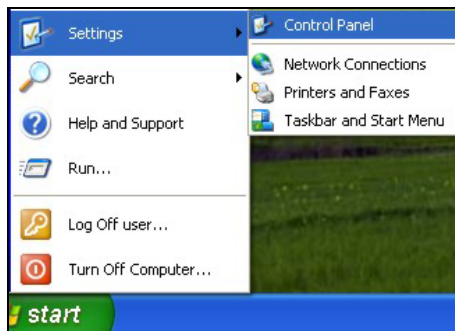

**Step 2.** Click **Add or Remove Programs**.

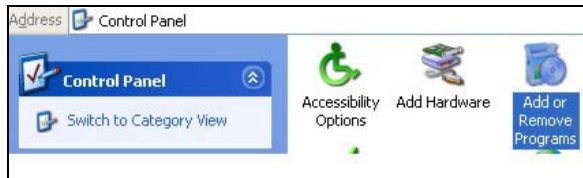

**Step 3.** Click **ZyXEL Power over Ethernet Series** and **Change/Remove**.

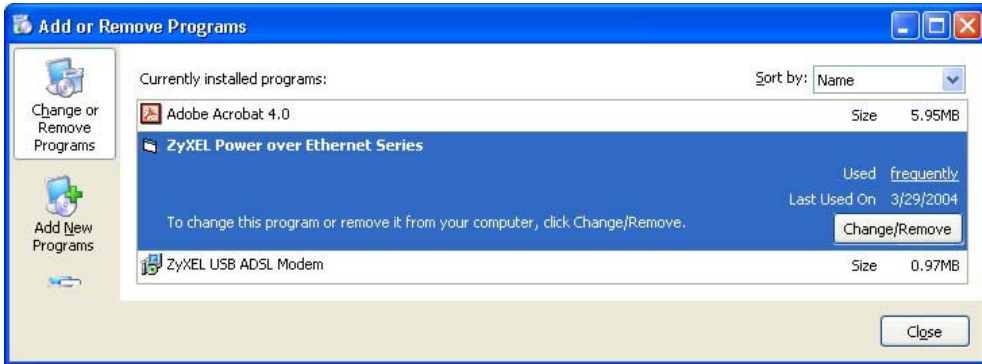

**Step 4.** Click **Yes** to remove the software utility.

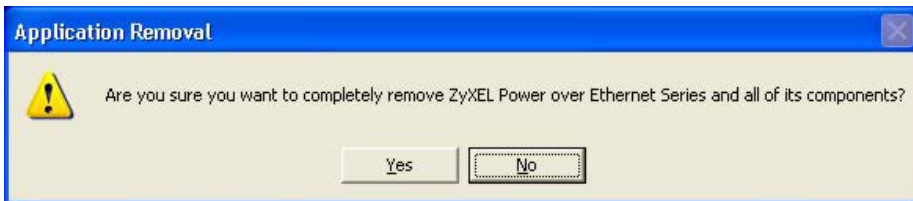

**Step 5.** Click **OK**.

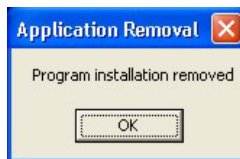



# 5 Managing the PoE-80

Connect to the PoE-80 through a computer connected to the console port. Then, connect a PoE-enabled device to a **DATA OUT** port on the PoE-80. Start the utility and the management interface displays as shown next.

**The configuration changes you make in the utility are not saved when you turn off the power to the PoE-80.**

**System Setup & Control**

Master Enable     Calibrate System

PD Discovery R (ohms): Upper Limit:  Lower Limit:

**System Info**

Chip Version: **Chip Ver.**  
Firmware Version: **Fw Ver.**  
Utility Version: **1.06**  
Current Port Serviced: **Port #**  
Total Port Power (W): **Port #**

**Device Setting**

Enable Auto-Refresh

**Port Specific Control**

	Port 1	Port 2	Port 3	Port 4	Port 5	Port 6	Port 7	Port 8
Port Enable	<input checked="" type="checkbox"/>	<input checked="" type="checkbox"/>	<input checked="" type="checkbox"/>	<input checked="" type="checkbox"/>	<input checked="" type="checkbox"/>	<input checked="" type="checkbox"/>	<input checked="" type="checkbox"/>	<input checked="" type="checkbox"/>
Bypass Classification	<input type="checkbox"/>	<input type="checkbox"/>	<input type="checkbox"/>	<input type="checkbox"/>	<input type="checkbox"/>	<input type="checkbox"/>	<input type="checkbox"/>	<input type="checkbox"/>
Bypass Detection	<input type="checkbox"/>	<input type="checkbox"/>	<input type="checkbox"/>	<input type="checkbox"/>	<input type="checkbox"/>	<input type="checkbox"/>	<input type="checkbox"/>	<input type="checkbox"/>
LED Status Indicators	<span style="color:red">●</span> <span style="color:yellow">●</span> <span style="color:green">●</span>	<span style="color:red">●</span> <span style="color:yellow">●</span> <span style="color:green">●</span>	<span style="color:red">●</span> <span style="color:yellow">●</span> <span style="color:green">●</span>	<span style="color:red">●</span> <span style="color:yellow">●</span> <span style="color:green">●</span>	<span style="color:red">●</span> <span style="color:yellow">●</span> <span style="color:green">●</span>	<span style="color:red">●</span> <span style="color:yellow">●</span> <span style="color:green">●</span>	<span style="color:red">●</span> <span style="color:yellow">●</span> <span style="color:green">●</span>	<span style="color:red">●</span> <span style="color:yellow">●</span> <span style="color:green">●</span>
Fault Status	[status]	[status]	[status]	[status]	[status]	[status]	[status]	[status]
Mode Status	[status]	[status]	[status]	[status]	[status]	[status]	[status]	[status]
<b>Parametric Information</b>								
Discovery R (ohms)	[ohm]	[ohm]	[ohm]	[ohm]	[ohm]	[ohm]	[ohm]	[ohm]
Port Current (mA)	[mA]	[mA]	[mA]	[mA]	[mA]	[mA]	[mA]	[mA]
Port Voltage (V)	[V]	[V]	[V]	[V]	[V]	[V]	[V]	[V]
Port Power (W)	[W]	[W]	[W]	[W]	[W]	[W]	[W]	[W]
Class Current (mA)	[mA]	[mA]	[mA]	[mA]	[mA]	[mA]	[mA]	[mA]
Determined Class	[Class]	[Class]	[Class]	[Class]	[Class]	[Class]	[Class]	[Class]

## 5.1 System Setup & Control

This section of the screen controls the main system level parameters setup for the PoE-80.

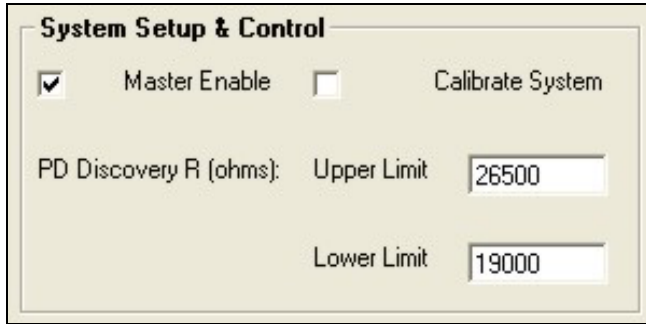

LABEL	DESCRIPTION
Master Enable	This field enables or disables the use of the utility to control the ports. You must enable this item to the utility to control the ports.
Calibrate System	When the PoE-80 is not functioning properly, select this check box and click <b>Save to Device</b> to reset the PoE-80 to the default settings. The device resets and the <b>PWR FWD</b> and <b>PWR OFF</b> LEDs flash. <hr/> <p style="text-align: center;"><b>You must disconnect all of the PoE-enabled devices from the PoE-80 before you calibrate the system.</b></p>
PD Discovery R(ohms)	Set the upper and lower limit resistor values for the discovery of Powered Devices (PD). The range is 19500~26500.

## 5.2 System Information

This section of the screen displays the hardware version, firmware version and the reset, update, port control function buttons.



LABEL	DESCRIPTION
Chip Version	This displays the version of the PoE-80's chipset.

LABEL	DESCRIPTION
Firmware Version	This displays the PoE-80's firmware version.
Utility Version	This displays the version of this utility.
Current Port Serviced	This displays the port that the system's internal state sequencer is presently accessing.
Total Port Power (W)	This displays the total power of the PoE-80's ports (combined) in the system.
Enable Auto-Refresh	Select this check box to have the system automatically refresh the system parameters (about once every two seconds).
Load from Device	Click this button to display the PoE-80's configuration in the utility's screen.
Save to Device	When you have made configuration changes, click this button to apply the new configuration to the PoE-80. Configuration changes are lost when you turn off the PoE-80 or it loses power.

### 5.3 Port Specific Control

This section of the screen displays port specific function controls.

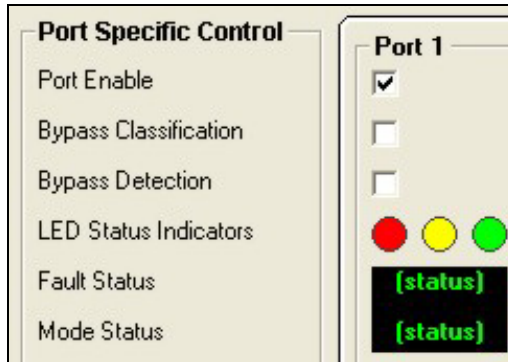

LABEL	DESCRIPTION
Port Enable	Select this check box to enable the port. This function corresponds with the master enable function.
Bypass Classification	Select this check box to have the system skip the power classification and directly transmit power to the PoE-enabled device. When this check box is clear, the PoE-80 checks the current level in order to classify the IEEE 802.3af compliant PoE-enabled device.
Bypass Detection	Select this check box to bypass the PoE-enabled device detection function. When this check box is clear, the PoE-80 attempts to detect the 25,000-Ohm resistor in an IEEE 802.3af compliant PoE-enabled device.

CLASS	USAGE	POWER DEVICE POWER (W)		CLASSIFICATION CURRENT (MA)	
		MIN	MAX	MIN	MAX
0	Default	0.44	12.95	0	4
1	Optional	0.44	3.84	9	12
2	Optional	3.84	6.49	17	20
3	Optional	6.49	12.95	26	30
4	Optional	Reserved for future use		36	44

LABEL	DESCRIPTION
LED Status Indicators	<p>This is the current LED indicator display – green, red, or yellow. The LED indicator changes depending on the status of the connected PoE-enabled device.</p> <p>Green: The PoE-enabled device is connected to the port and functioning properly.            Red: Error, the PoE-enabled device connected to the port needs more power than the PoE-80 can provide or the Ethernet cable has shorted.            Yellow: No PoE-enabled device is connected to the port.</p>
Fault Status	<p>This displays the status (Null, Overload or DR Fail) of the connected PoE-enabled device that the system has detected.</p> <p>Null: No PoE-enabled device is connected to the port.            Overload: The current went higher than 475mA @48V DC for more than 50 milliseconds.            DR Fail: The PoE-enabled device's discovery resistor is not within the range defined in IEEE 802.3af (19,600 to 26,500 Ohm).</p>
Mode Status	<p>This displays the status (I sample, V sample or R detect) of the connection to a PoE-enabled device.</p> <p>I sample: The PoE-80 is sending current to detect whether or not the PoE-enabled device is still connected to the port.            V sample: The PoE-80 is sending voltage to detect whether or not the PoE-enabled device is still connected to the port.            R detect: The PoE-80 is trying to detect the resistor of a PoE-enabled device (the port is not connected to a PoE-enabled device).</p>

## 5.4 Parametric Information

This section of the screen displays individual port parameters.

Parametric Information	
Discovery R (ohms)	(ohm)
Port Current (mA)	(mA)
Port Voltage (V)	(V)
Port Power (W)	(W)
Class Current (mA)	(mA)
Determined Class	(Class)

LABEL	DESCRIPTION
Discovery R (ohms)	This field displays the port's resistance value.
Port Current (mA)	This field displays the port's current value.
Port Voltage (V):	This field displays the port's voltage value.
Port Power (W)	This field displays the port's watt value.
Class Current (mA)	This field displays the port's class current value. This class current value does not display when you enable the bypass classification function.
Determined Class	This field displays the port's power class. The class value does not display when you enable the bypass classification function.

## 6 Troubleshooting

Make sure you have securely attached the proper cables to the proper ports. Refer to the *Rear Panel Connections* and *Front Panel Connections* sections for this information. If your PoE-80 still does not work properly, refer to the table shown next.

PROBLEM	CORRECTIVE ACTION
No LEDs are on when I turn on the PoE-80.	Check to see that the power cord is properly connected to the PoE-80 and an appropriate power source. Make sure the power source is turned on and that the PoE-80 is receiving sufficient power. Contact your local distributor if the problem persists.
The PWR FWD LED is not on or is blinking.	Check to see that the Ethernet cables are connected properly. Contact your local distributor if the problem persists.

PROBLEM	CORRECTIVE ACTION
Power is not being supplied to my PoE-enabled devices.	Ensure that the Ethernet cables connecting the PoE-enabled devices to the PoE-80's <b>DATA OUT</b> ports are securely attached. Make sure the PoE-80 is connected to a power source.

## 7 Specifications

Standards	IEEE 802.3af
Ports	8 <b>DATA IN</b> RJ-45 Ethernet ports 8 <b>DATA OUT</b> PoE injector RJ-45 Ethernet ports 1 RS-232 console port
LEDs	System: Power Per Port (2 LEDs): Power Forwarding, Power Off
Power Output	-48V DC, 100 Watts maximum Current (per port maximum): 350mA @ 48V DC
Management	Microsoft Windows-based application for power management
Power Management Functions	Current ports serviced list, system total serviced power budget, power port disable/ enable, power support priority, power overload auto shut down, power port operation status, power consumption limit
Weight	2.7 kg
Cooling	2 DC fans
Dimensions	440(W) x 224(D) x 44(H) mm (19" in width rack mountable)
Power Supply	100 - 240V AC, 50/60Hz internal universal power supply with fuse and power switch
Power Consumption	130 Watts maximum
Operating Temperature	0 – 45 degrees Celsius (32 – 104 degrees Fahrenheit)
Operational Humidity	10% to 95% (Non-condensing)
EMI and Safety	FCC Class A, CE, UL, cUL

## 7.1 DATA OUT PoE Injector RJ-45 Port Pin Assignments

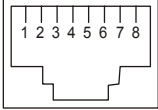
	PIN NO	RJ-45 SIGNAL ASSIGNMENT
	1	Output Transmit Data +
	2	Output Transmit Data -
	3	Receive Data +
	4	Power +
	5	Power +
	6	Receive Data -
	7	Power -
	8	Power -