

Prestige 650M

ADSL Bridge

User's Guide

Version 3.40

March 2003



Copyright

Copyright © 2003 by ZyXEL Communications Corporation.

The contents of this publication may not be reproduced in any part or as a whole, transcribed, stored in a retrieval system, translated into any language, or transmitted in any form or by any means, electronic, mechanical, magnetic, optical, chemical, photocopying, manual, or otherwise, without the prior written permission of ZyXEL Communications Corporation.

Published by ZyXEL Communications Corporation. All rights reserved.

Disclaimer

ZyXEL does not assume any liability arising out of the application or use of any products, or software described herein. Neither does it convey any license under its patent rights nor the patent rights of others. ZyXEL further reserves the right to make changes in any products described herein without notice. This publication is subject to change without notice.

Trademarks

ZyNOS (ZyXEL Network Operating System) is a registered trademark of ZyXEL Communications, Inc. Other trademarks mentioned in this publication are used for identification purposes only and may be properties of their respective owners.

Federal Communications Commission (FCC) Interference Statement

This device complies with Part 15 of FCC rules. Operation is subject to the following two conditions:

- This device may not cause harmful interference.
- This device must accept any interference received, including interference that may cause undesired operations.

This equipment has been tested and found to comply with the limits for a Class B digital device pursuant to Part 15 of the FCC Rules. These limits are designed to provide reasonable protection against harmful interference in a commercial environment. This equipment generates, uses, and can radiate radio frequency energy, and if not installed and used in accordance with the instructions, may cause harmful interference to radio communications.

If this equipment does cause harmful interference to radio/television reception, which can be determined by turning the equipment off and on, the user is encouraged to try to correct the interference by one or more of the following measures:

1. Reorient or relocate the receiving antenna.
2. Increase the separation between the equipment and the receiver.
3. Connect the equipment into an outlet on a circuit different from that to which the receiver is connected.
4. Consult the dealer or an experienced radio/TV technician for help.

Notice 1

Changes or modifications not expressly approved by the party responsible for compliance could void the user's authority to operate the equipment.

Certifications

Refer to the product page at www.zyxel.com.

ZyXEL Limited Warranty

ZyXEL warrants to the original end user (purchaser) that this product is free from any defects in materials or workmanship for a period of up to two years from the date of purchase. During the warranty period, and upon proof of purchase, should the product have indications of failure due to faulty workmanship and/or materials, ZyXEL will, at its discretion, repair or replace the defective products or components without charge for either parts or labor, and to whatever extent it shall deem necessary to restore the product or components to proper operating condition. Any replacement will consist of a new or re-manufactured functionally equivalent product of equal value, and will be solely at the discretion of ZyXEL. This warranty shall not apply if the product is modified, misused, tampered with, damaged by an act of God, or subjected to abnormal working conditions.

Note

Repair or replacement, as provided under this warranty, is the exclusive remedy of the purchaser. This warranty is in lieu of all other warranties, express or implied, including any implied warranty of merchantability or fitness for a particular use or purpose. ZyXEL shall in no event be held liable for indirect or consequential damages of any kind of character to the purchaser.

To obtain the services of this warranty, contact ZyXEL's Service Center for your Return Material Authorization number (RMA). Products must be returned Postage Prepaid. It is recommended that the unit be insured when shipped. Any returned products without proof of purchase or those with an out-dated warranty will be repaired or replaced (at the discretion of ZyXEL) and the customer will be billed for parts and labor. All repaired or replaced products will be shipped by ZyXEL to the corresponding return address, Postage Paid. This warranty gives you specific legal rights, and you may also have other rights that vary from country to country.

Customer Support

Please have the following information ready when you contact customer support.

- Product model and serial number.
- Information in **Menu 24.2.1 – System Information**.
- Warranty Information.
- Date that you received your device.
- Brief description of the problem and the steps you took to solve it.

METHOD	E-MAIL SUPPORT/SALES	TELEPHONE/FAX	WEB SITE/ FTP SITE	REGULAR MAIL
LOCATION				
WORLDWIDE	support@zyxel.com.tw sales@zyxel.com.tw	+886-3-578-3942 +886-3-578-2439	www.zyxel.com www.europe.zyxel.com ftp.europe.zyxel.com	ZyXEL Communications Corp., 6 Innovation Road II, Science-Based Industrial Park, Hsinchu 300, Taiwan
NORTH AMERICA	support@zyxel.com sales@zyxel.com	+1-714-632-0882 800-255-4101 +1-714-632-0858	www.zyxel.com ftp.zyxel.com	ZyXEL Communications Inc., 1650 Miraloma Avenue, Placentia, CA 92870, U.S.A.
SCANDINAVIA	support@zyxel.dk sales@zyxel.dk	+45-3955-0700 +45-3955-0707	www.zyxel.dk ftp.zyxel.dk	ZyXEL Communications A/S, Columbusvej 5, 2860 Soeborg, Denmark
GERMANY	support@zyxel.de sales@zyxel.de	+49-2405-6909-0 +49-2405-6909-99	www.zyxel.de	ZyXEL Deutschland GmbH, Adenauerstr. 20/A2 D-52146 Wuersele, Germany

Table of Contents

Copyright	ii
Federal Communications Commission (FCC) Interference Statement	iii
ZyXEL Limited Warranty	iv
Customer Support	v
List of Figures	x
List of Tables	xii
Preface	xiii
What is DSL?	xv
Chapter 1 Getting To Know Your Prestige.....	1-1
1.1 Prestige 650M ADSL Bridge	1-1
1.2 Features of the Prestige.....	1-1
1.3 Applications for the Prestige	1-3
Chapter 2 Hardware Installation and Initial Setup	2-1
2.1 Front Panel LEDs of the Prestige	2-1
2.2 Rear Panel of the Prestige	2-2
2.3 Connecting an ISDN Splitter	2-4
2.4 Turning On Your Prestige.....	2-5
Chapter 3 Initial Setup	3-1
3.2 Prestige SMT Overview	3-1
3.3 Navigating the SMT Interface	3-2
3.4 Changing the System Password.....	3-4
3.5 SMT Menu 1: General Setup	3-6
3.6 LANs and WANs	3-6
3.7 SMT Menu 3: TCP/IP LAN Setup.....	3-8
Chapter 4 Internet Access	4-1
4.1 Introduction	4-1
4.2 VPI and VCI	4-1

4.3	Multiplexing	4-2
4.4	Encapsulation	4-2
4.5	Internet Access Configuration	4-4
Chapter 5	Remote Node Configuration	5-1
5.1	Remote Node Setup	5-1
Chapter 6	Filter Set Configuration	6-1
6.1	About Filtering	6-1
6.2	Configuring a Filter Set.....	6-3
6.3	Generic Filter Rule	6-4
6.4	Filter Configuration Example.....	6-6
6.5	Applying Filters.....	6-7
Chapter 7	System Information and Diagnosis.....	7-1
7.1	Introduction.....	7-1
7.2	System Status	7-1
7.3	System Information and Console Port Speed	7-3
7.4	Diagnostic.....	7-5
7.5	Command Interpreter Mode	7-6
Chapter 8	Firmware and Configuration File Maintenance	8-1
8.1	Identifying Your Product	8-1
8.2	Filename Conventions.....	8-1
8.3	Backup Configuration	8-2
8.4	Restore Configuration	8-6
8.5	Uploading Firmware and Configuration Files.....	8-8
Chapter 9	Troubleshooting.....	9-1
9.1	Problems Starting the Prestige.....	9-1
9.2	Power Problems	9-1
9.3	Problems Connecting to the LAN.....	9-2
9.4	Problems Connecting with the WAN or Remote Node/ISP.....	9-2
9.5	Problems Accessing the SMT Menu	9-3

9.6 Problems Accessing the Internet 9-3

Appendix A Power Adapter Specifications..... A

Appendix B Virtual Circuit Topology..... C

Appendix C Setting up Your Computer’s IP Address D

Index..... O

List of Figures

Figure 1-1 Internet Access Application.....	1-3
Figure 1-2 LAN-to-LAN Application.....	1-4
Figure 2-1 Prestige Front Panel.....	2-1
Figure 2-2 Prestige Rear Panel and Connections.....	2-2
Figure 2-3 ISDN Splitter Installation.....	2-4
Figure 3-1 Password Screen.....	3-1
Figure 3-2 Prestige SMT Menu Overview.....	3-2
Figure 3-3 SMT Main Menu.....	3-4
Figure 3-4 Menu 23 – System Password.....	3-5
Figure 3-5 Menu 1–General Setup.....	3-6
Figure 3-6 LAN & WAN IPs.....	3-7
Figure 3-7 Menu 3.2 – TCP/IP and DHCP Ethernet Setup.....	3-8
Figure 4-1 Example of Traffic Shaping.....	4-4
Figure 4-2 Internet Access Setup.....	4-4
Figure 5-1 Menu 11–Remote Node Setup.....	5-1
Figure 5-2 Menu 11.1-Remote Node Profile.....	5-2
Figure 6-1 Filter Rule Process.....	6-2
Figure 6-2 Menu 21–Filter Set Configuration.....	6-3
Figure 6-3 Menu 21.1–Filter Rules Summary.....	6-3
Figure 6-4 Menu 21.5.1–Generic Filter Rule.....	6-5
Figure 6-5 Sample Filter Rules Summary – Menu 21.3.....	6-7
Figure 6-6 Filtering Remote Node Traffic.....	6-8
Figure 7-1 Menu 24 – System Maintenance.....	7-1
Figure 7-2 Menu 24.1 – System Maintenance – Status.....	7-2
Figure 7-3 Menu 24.2 – System Information and Console Port Speed.....	7-3
Figure 7-4 Menu 24.2.1 – System Maintenance – Information.....	7-4

Figure 7-5 Menu 24.2.2 – System Maintenance – Change Console Port Speed	7-5
Figure 7-6 Menu 24.4 – System Maintenance – Diagnostic	7-6
Figure 7-7 Command Mode in Menu 24.....	7-7
Figure 7-8 Valid Commands	7-7
Figure 8-1 Telnet in Menu 24.5.....	8-3
Figure 8-2 FTP Session Example.....	8-4
Figure 8-3 Telnet into Menu 24.6.....	8-7
Figure 8-4 Restore Using FTP Session Example	8-7
Figure 8-5 Telnet Into Menu 24.7.1 - Upload System Firmware	8-8
Figure 8-6 Telnet Into Menu 24.7.2 - System Maintenance	8-9
Figure 8-7 FTP Session Example of Firmware File Upload	8-10

List of Tables

Table 1 P650M Models	xiii
Table 2-1 Front Panel LED Description	2-1
Table 3-1 Main Menu Commands	3-3
Table 3-2 Main Menu Summary	3-4
Table 3-3 General Setup Menu Fields	3-6
Table 3-4 TCP/IP Ethernet Setup Menu Fields	3-8
Table 4-1 Internet Account Information	4-1
Table 4-2 Internet Access Setup Menu Fields	4-5
Table 5-1 Remote Node Profile Menu Fields	5-2
Table 6-1 Abbreviations Used in the Filter Rules Summary Menu	6-4
Table 6-2 Rule Abbreviations Used	6-4
Table 6-3 Menu 21.5.1 – Generic Filter Rule Fields	6-5
Table 6-4 Filter Set Types	6-7
Table 7-1 System Maintenance – Status Menu Fields	7-2
Table 7-2 Fields in System Maintenance	7-4
Table 7-3 System Maintenance Menu – Diagnostic	7-6
Table 8-1 Filename Conventions	8-2
Table 8-2 General Commands for GUI-based FTP Clients	8-4
Table 8-3 General Commands for GUI-based TFTP Clients	8-5
Table 9-1 Problems Starting the Prestige	9-1
Table 9-2 Problems With the Power Source	9-1
Table 9-3 Problems Connecting with the LAN	9-2
Table 9-4 Problems Connecting with the WAN or Remote Node/ISP	9-2
Table 9-5 Problems Accessing SMT Menus	9-3
Table 9-6 Problems Accessing the Internet	9-3

Preface

Congratulations on your purchase of the Prestige 650M Ethernet Bridge.

There are three types of P650M bridges. Please refer to the label under your device to see which type you have. The key hardware difference is the DSL connector. The analog model uses an RJ-11 connector while the digital models use RJ-45 connectors. The firmware features of all three models are identical.

Table 1 P650M Models

MODEL TYPE	DESCRIPTION
P650M-31	Analog model for ADSL over POTS (Plain Old telephone System). RJ-11 connector
P650M-33	Analog model for ADSL over ISDN. RJ-45 connector.
P650M-37	Analog model for ADSL over ISDN in Germany. RJ-45 connector.

The Prestige 650M is an ADSL bridge used for Internet/LAN access via POTS or ISDN line. The Prestige can run maximum upstream transmission rates of up to 832Kbps and maximum downstream transmission rates of 8Mbps. The actual rate depends on the copper category of your phone line and distance from the central office. See the *What is DSL* section for more background information on DSL and ADSL.

The Prestige's 10/100M auto-negotiating LAN interface enables fast data transfer of either 10Mbps or 100Mbps in either half-duplex or full-duplex mode depending on your Ethernet network.

Your Prestige is easy to install and configure. All functions of the Prestige are software configurable via the SMT (System Management Terminal) using Telnet.

Register your Prestige online at www.zyxel.com for free future product updates and information.

About This User's Guide

This User's Guide covers all P650M models, their operation and shows you how to get the best out of the multiple advanced features of your DSL Internet access modem using SMT menus. It is designed to guide you through the correct configuration of your Prestige for various applications.

Related Documentation

- Support Disk
Refer to the included CD for support documents.
- Read Me First

Our Read Me First is designed to help you get up and running right away. It contains a detailed easy-to-follow connection diagram, default settings, handy checklists and information on setting up your network and configuring for Internet access.

➤ ZyXEL Glossary and Web Site

Please refer to www.zyxel.com for an online glossary of networking terms and additional support documentation.

Syntax Conventions

- “Type” means for you to type one or more characters and press the carriage return. “Select” or “Choose” means for you to use one from the predefined choices.
- The SMT menu titles and labels are in **Bold Times New Roman** font. Predefined field choices are in **Bold Arial** font. Command and arrow keys are enclosed in square brackets. [ENTER] means the Enter, or carriage return key; [ESC] means the Escape key and [SPACE BAR] means the Space Bar.
- For brevity’s sake, we may use “e.g.,” as shorthand for “for instance”, and “i.e.,” for “that is” or “in other words” in this manual.
- The Prestige 650M ADSL Bridge may be referred to as the Prestige in this User’s Guide when referring to all three models and to P650M-31, P650M-33 or P650M-37 when referring to the specific model.

The following section offers some background information on DSL. Skip to Chapter 1 if you wish to begin working with your modem right away.

What is DSL?

DSL (Digital Subscriber Line) enhances the data capacity of the existing twisted-pair wire that runs between the local telephone company switching offices and most homes and offices. While the wire itself can handle higher frequencies, the telephone switching equipment is designed to cut off signals above 4,000 Hz to filter noise off the voice line, but now everybody is searching for ways to get more bandwidth to improve access to the Web - hence DSL technologies.

There are actually seven types of DSL service, ranging in speeds from 16 Kbits/sec to 52 Mbits/sec. The services are either symmetrical (traffic flows at the same speed in both directions), or asymmetrical (the downstream capacity is higher than the upstream capacity). Asymmetrical services (ADSL) are suitable for Internet users because more information is usually downloaded than uploaded. For example, a simple button click in a web browser can start an extended download that includes graphics and text.

As data rates increase, the carrying distance decreases. That means that users who are beyond a certain distance from the telephone company's central office may not be able to obtain the higher speeds.

A DSL connection is a point-to-point dedicated circuit, meaning that the link is always up and there is no dialing required.

What is ADSL?

It is an asymmetrical technology, meaning that the downstream data rate is much higher than the upstream data rate. As mentioned, this works well for a typical Internet session in which more information is downloaded, for example, from Web servers, than is uploaded. ADSL operates in a frequency range that is above the frequency range of voice services, so the two systems can operate over the same cable.

Chapter 1

Getting To Know Your Prestige

This chapter describes the key features and applications of your Prestige.

1.1 Prestige 650M ADSL Bridge

Your Prestige integrates a high-speed 10/100Mbps auto-negotiating LAN interface and one high-speed DSL port into a single package. The Prestige is ideal for high-speed Internet browsing and making LAN-to-LAN connections to remote networks.

1.2 Features of the Prestige

Your Prestige is packed with a number of features that give it the flexibility to provide a complete networking solution for almost any user.

- **High Speed Internet Access**

Your Prestige supports downstream transmission rates of up to 8Mbps and upstream transmission rates of 832 Kbps. Your Prestige also supports rate management.

- **10/100M Auto-negotiation Ethernet/Fast Ethernet Interface**

This auto-negotiation feature allows the Prestige to detect the speed of incoming transmissions and adjust appropriately without manual intervention. It allows data transfer of either 10 Mbps or 100 Mbps in either half-duplex or full-duplex mode depending on your Ethernet network.

- **Multiple PVC (Permanent Virtual Circuits) Support**

Your Prestige supports up to 8 PVCs.

- **DSL Transmission Rate Standards**

- ◆ Full-Rate (ANSI T1.413, Issue 2; G.dmt (G.992.1) with line rate support of up to 8 Mbps downstream and 832 Kbps upstream.
- ◆ Supports Multi-Mode standard (ITU G.992.1, G.994.1, G.997.1).
- ◆ TCP/IP (Transmission Control Protocol/Internet Protocol) network layer protocol.
- ◆ ATM Forum UNI 3.1/4.0 PVC.

- ◆ PPP over AAL5 (RFC 2364).
- ◆ EOC specified in ITU-T G.992.1
- ◆ Dying Gasp
- ◆ IP Bridge Mode

● **Protocol Support**

- ◆ PPP (Point-to-Point Protocol) (RFC 1144, 1332, 1334, 1570, 1661, 1994, 1998 (plus amendments))
- ◆ Multiprotocol Encapsulation over ATM (MpoA) (RFC 1483/2684)
- ◆ Transparent bridging for unsupported network layer protocols

● **Networking Compatibility**

Your Prestige is compatible with the major DSL DSLAM (Digital Subscriber Line Access Multiplexer) providers, making configuration as simple as possible for you.

● **Multiplexing**

The Prestige Series supports VC-based and LLC-based multiplexing.

● **Encapsulation**

The Prestige supports PPPoA (RFC 2364 - PPP over ATM Adaptation Layer 5) and RFC 1483 encapsulation over ATM.

Network Management

- ◆ Menu driven SMT (System Management Terminal) management
- ◆ CLI (Command Line Interpreter)
- ◆ Remote SMT session via Telnet
- ◆ Local SMT session via Telnet
- ◆ Built-in Diagnostic Tools
- ◆ Syslog
- ◆ Telnet Support (Password-protected telnet access to internal configuration manager)
- ◆ TFTP/FTP server, firmware upgrade and configuration backup/support supported
- ◆ Supports OAM F4/F5 loop-back, AIS and RDI OAM cells

● Diagnostics Capabilities

The Prestige can perform self-diagnostic tests. These tests check the integrity of the following circuitry:

- FLASH memory
- DSL circuitry
- RAM
- LAN port

● Filters

The Prestige's packet filtering functions allows added network security and management.

● Ease of Installation

Your Prestige is designed for quick, intuitive and easy installation.

● Housing

Your Prestige's all new compact and ventilated housing minimizes space requirements making it easy to position anywhere in your busy office. The Prestige is easy to mount on your wall.

1.3 Applications for the Prestige

1.3.1 Internet Access

The Prestige is the ideal high-speed Internet access solution. Your Prestige supports the TCP/IP protocol, which the Internet uses exclusively. It is compatible with all major DSL DSLAM (Digital Subscriber Line Access Multiplexer) providers. A DSLAM is a rack of DSL line cards with data multiplexed into a backbone network interface/connection (for example, T1, OC3, DS3, ATM or Frame Relay). Think of it as the equivalent of a modem rack for DSL. A typical Internet Access application is shown below.

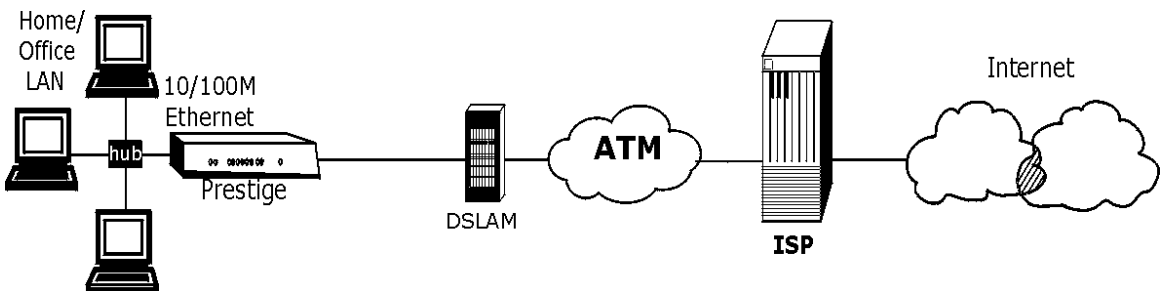

Figure 1-1 Internet Access Application

1.3.2 LAN to LAN Application

You can use the Prestige to connect two geographically dispersed networks over the DSL line. A typical LAN-to-LAN application for your Prestige is shown as follows.

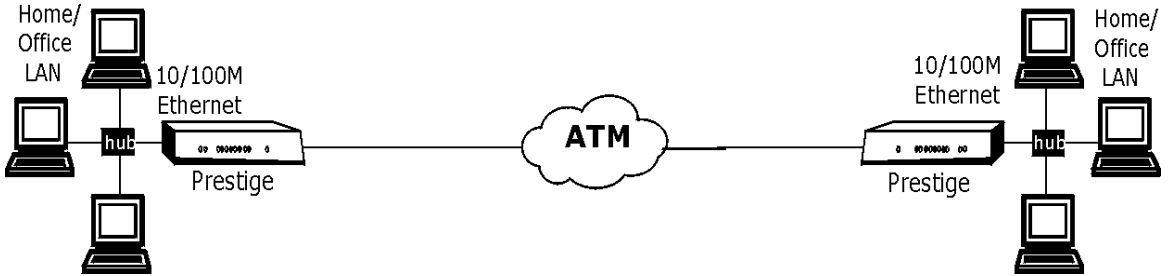

Figure 1-2 LAN-to-LAN Application

Chapter 2

Hardware Installation and Initial Setup

This chapter describes the physical features of the Prestige and how to make cable connections.

2.1 Front Panel LEDs of the Prestige

The LEDs on the front panel indicate the operational status of your Prestige



Figure 2-1 Prestige Front Panel

Table 2-1 Front Panel LED Description

LED	COLOR	STATUS	DESCRIPTION
PWR	Green	On	The Prestige is receiving power.
		Off	The Prestige is not receiving power.
SYS	Green	On	The Prestige is functioning properly.
		Blinking	The Prestige is rebooting.
		Off	The Prestige is not ready or has malfunctioned.
	Red	On	Prestige power is low and consequently may be disconnected from the DSL line.
LAN 10M	Green	On	The Prestige has a successful 10Mb Ethernet connection.
		Blinking	The Prestige is sending/receiving data.
		Off	The Prestige does not have 10Mb Ethernet connection.

Table 2-1 Front Panel LED Description

LED	COLOR	STATUS	DESCRIPTION
LAN 100M	Orange	On	The Prestige has a successful 100Mb Ethernet connection.
		Blinking	The Prestige is sending/receiving data.
		Off	The Prestige does not have 100Mb Ethernet connection.
DSL	Green	On	The Prestige is linked successfully to a DSLAM.
		Blinking	The Prestige is synchronizing.
		Off	The DSL link is down.
Act	Green	Blinking	The Prestige is sending/receiving data.
		Off	The Prestige is not sending/receiving data.

2.2 Rear Panel of the Prestige

The following figure shows the rear panel and connections of your Prestige.

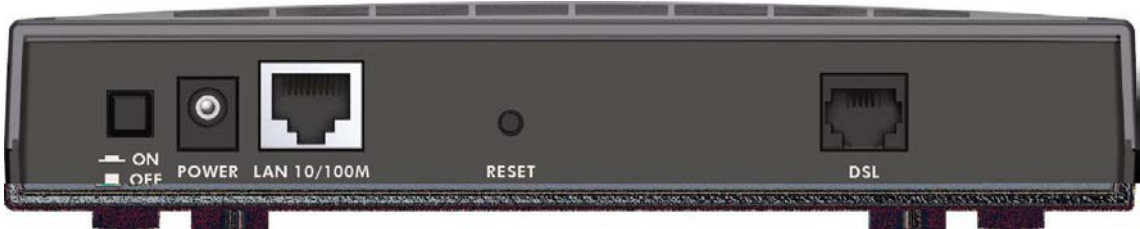

Figure 2-2 Prestige Rear Panel and Connections

2.2.1 DSL Port

There are three types of P650M bridges. Please refer to the label under your device to see which type you have. The key hardware difference is the DSL connector. The analog model uses an RJ-11 connector while the digital models use RJ-45 connectors.

➤	P650M-31	RJ-11 connector
➤	P650M-33	RJ-45 connector.
➤	P650M-37	RJ-45 connector.

Connect the Prestige to the wall jack using the included DSL cable. For the P650M-33 and P650M-37 models, connect an ISDN splitter between the wall jack and your telephone(s) and computer(s).

2.2.2 LAN 10/100M Port

Ethernet 10Base-T/100Base-T networks use Shielded Twisted Pair (STP) cable. This port is auto-sensing which means Use a crossover cable or a straight-through Ethernet cable to connect your Prestige to a computer or an external hub. If the Prestige is connected directly to a hub, connect one end of the straight-through cable from the hub to the NIC on the computer.

When the Prestige is on and properly connected to a computer or a hub, the corresponding LAN LED on the front panel turns on.

2.2.3 Power Port

Connect the power adapter to the port labeled **POWER** on the rear panel of your Prestige.

To avoid damage to the Prestige, make sure you use the correct power adapter. Refer to the *Power Adapter Specification Appendix* for this information.

2.2.4 Reset Button

If you have forgotten your password or cannot access the Prestige you will need to use the RESET button on the rear panel of the Prestige to reload the factory-default configuration file. Uploading the configuration file replaces the current configuration file with the default configuration file and deletes all previous Prestige configurations. The following are the factory defaults for the Prestige.

- IP address: 192.168.1.1
- Password: 1234

2.2.5 Procedure to Use the RESET Button

- Step 1.** Use a pen or pointed object to press the **RESET** button for 5-10 seconds or until the **SYS LED** flashes and then release it.
- Step 2.** If the **SYS LED** turns steady on and the **LAN LED** flashes within 30 seconds, the factory defaults have been restored and the Prestige restarts. Otherwise, go to step 3.
- Step 3.** Turn the Prestige off.
- Step 4.** While pressing the **RESET** button, turn the Prestige on.

Step 5. Continue to hold the **RESET** button for about 30 seconds. The Prestige restarts.

Step 6. Release the **RESET** button and wait for the Prestige to finish restarting.

2.3 Connecting an ISDN Splitter

This section is relevant for P650M-33 and P650M-37 models only!

This device keeps the ISDN and DSL signals separated, giving them the capability to provide simultaneous Internet access and ISDN service on the same line. Splitters also eliminate the destructive interference conditions caused by telephone sets. The purchase of an ISDN splitter is optional.

Noise generated from a telephone in the same frequency range as the DSL signal, can disrupt the DSL signal. In addition the impedance of a telephone when off-hook may be so low that it shunts the strength of the DSL signal. When an ISDN splitter is installed at the entry point, where the line comes into the home, it will filter the ISDN signals before combining the DSL and ISDN signals transmitted and received. The issues of noise and impedance are eliminated with a single ISDN splitter installation.

An ISDN splitter is easy to install as shown in the following figure.

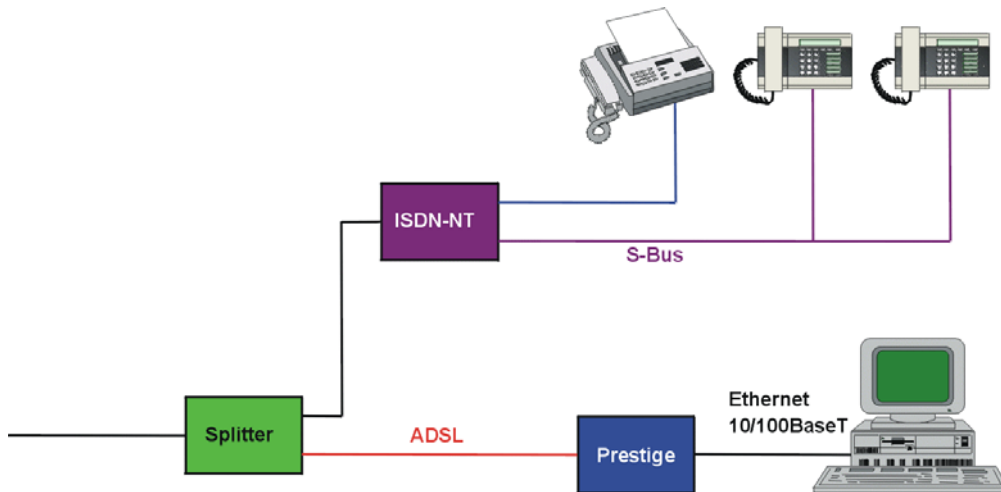

Figure 2-3 ISDN Splitter Installation

2.4 Turning On Your Prestige

At this point, you should have connected the DSL, LAN and Power ports to the appropriate devices. Make sure the power adapter is plugged into an appropriate power source.

Press the power switch in. The **Power** LED turns on. The **SYS** LED blinks and turns steady on. The **SYS** LED turns red if power is too low. The **LAN** and **DSL** LEDs turn on, if they are properly connected.

Chapter 3

Initial Setup

This chapter introduces the SMT and shows you how to configure SMT menus 1 and 3.

Configure your Prestige using the SMT (System Management Terminal) via LAN or WAN using Telnet.

3.1.1 Connect to Your Prestige Using Telnet

The following procedure details how to telnet into your Prestige.

Step 1. In Windows, click **Start** (usually in the bottom left corner), **Run** and then type “telnet 192.168.1.1” (the default IP address) and click **OK**.

Step 2. Enter 1234 in the **Password** field.

After entering the password you will see the main menu.

3.1.2 Entering Password

When you turn on your Prestige, it performs several internal tests as well as line initialization. After the initialization, the Prestige asks you for the password, as shown next.

For your first login, enter the default password “1234”. As you type the password, the screen displays an asterisk “*” for each character you type.

Please note that if there is no activity for longer than five minutes after you log in, your Prestige will automatically log you out.



Figure 3-1 Password Screen

3.2 Prestige SMT Overview

The following figure gives you an overview of the various SMT menu screens of your Prestige.

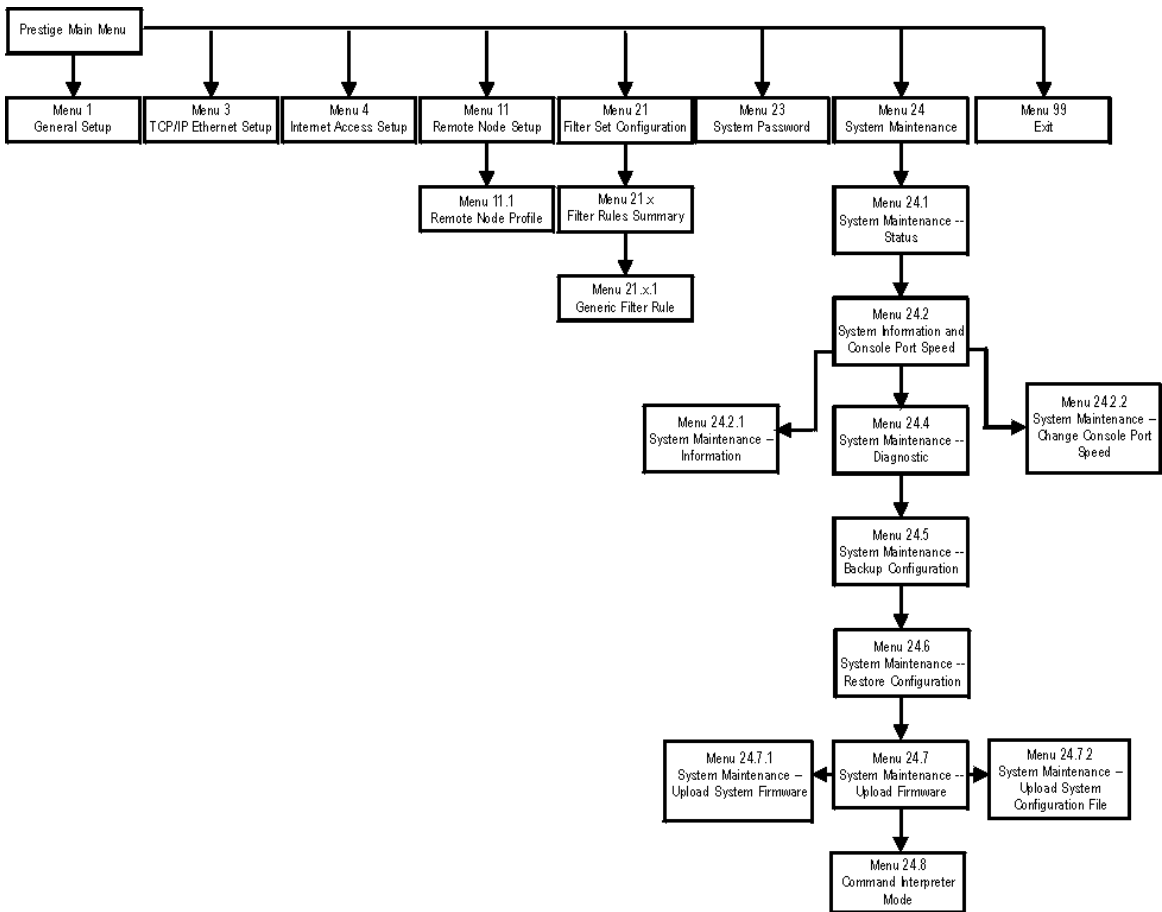

Figure 3-2 Prestige SMT Menu Overview

3.3 Navigating the SMT Interface

The SMT (System Management Terminal) is the interface that you use to configure your Prestige.

Several operations that you should be familiar with before you attempt to modify the configuration are listed in the table below.

Table 3-1 Main Menu Commands

OPERATION	KEYSTROKE	DESCRIPTION
Move down to another menu	[ENTER]	To move forward to a submenu, type in the number of the desired submenu and press [ENTER].
Move up to a previous menu	[ESC]	Press [ESC] to move back to the previous menu.
Move to a "hidden" menu	Press [SPACE BAR] to change No to Yes then press [ENTER].	Fields beginning with "Edit" lead to hidden menus and have a default setting of No . Press [SPACE BAR] once to change No to Yes , then press [ENTER] to go to the "hidden" menu.
Move the cursor	[ENTER] or [UP]/[DOWN] arrow keys.	Within a menu, press [ENTER] to move to the next field. You can also use the [UP]/[DOWN] arrow keys to move to the previous and the next field, respectively.
Entering information	Type in or press [SPACE BAR], then press [ENTER].	You need to fill in two types of fields. The first requires you to type in the appropriate information. The second allows you to cycle through the available choices by pressing [SPACE BAR].
Required fields	<?> or ChangeMe	All fields with the symbol <?> must be filled in order to be able to save the new configuration. All fields with ChangeMe must not be left blank in order to be able to save the new configuration.
N/A fields	<N/A>	Some of the fields in the SMT will show a <N/A>. This symbol refers to an option that is Not Applicable.
Save your configuration	[ENTER]	Save your configuration by pressing [ENTER] at the message "Press ENTER to confirm or ESC to cancel". Saving the data on the screen will take you, in most cases to the previous menu.
Exit the SMT	Type 99, then press [ENTER].	Type 99 at the main menu prompt and press [ENTER] to exit the SMT interface.

After you enter the password, the SMT displays the main menu, as shown next.

```

Copyright (c) 1994 - 2002 ZyXEL Communications Corp.

Prestige 650M-37 Main Menu

Getting Started                                Advanced Management
 1. General Setup                               21. Filter Set Configuration
 3. TCP/IP Ethernet Setup                       23. System Password
 4. Internet Access Setup                       24. System Maintenance

Advanced Applications
11. Remote Node Setup                           99. Exit

Enter Menu Selection Number:_
    
```

Figure 3-3 SMT Main Menu

3.3.1 System Management Terminal Interface Summary

Table 3-2 Main Menu Summary

#	MENU TITLE	DESCRIPTION
1	General Setup	Use this menu to set up your general information.
3	TCP/IP Ethernet Setup	Use this menu to set up your LAN connection.
4	Internet Access Setup	A quick and easy way to set up an Internet connection.
11	Remote Node Setup	Use this menu to set up the Remote Node for LAN-to-LAN connection, including Internet connection.
21	Filter Set Configuration	Use this menu to set up filters to provide security, etc.
23	System Password	Use this menu to change your password.
24	System Maintenance	This menu provides system status, diagnostics, software upload, etc.
99	Exit	Use this to exit from SMT and return to a blank screen.

3.4 Changing the System Password

This is highly recommended!

Change the Prestige default password by following the steps shown next.

Step 1. Enter 23 in the main menu to display **Menu 23 – System Password**, as shown next.

Step 2. Type your existing system password in the **Old Password** field, for example “1234”, and press [ENTER].

```
Menu 23 - System Password

Old Password= ****
New Password= ?
Retype to confirm= ?

Enter here to CONFIRM or ESC to CANCEL:
```

Figure 3-4 Menu 23 – System Password

Step 3. Type your new system password in the **New Password** field (up to 30 characters), and press [ENTER].

Step 4. Re-type your new system password in the **Retype to confirm** field for confirmation and press [ENTER].

Note that as you type a password, the screen displays an asterisk “*” for each character you type.

3.4.1 Resetting the Prestige

If you forget your password or cannot access the Prestige, you will need to reload the factory-default configuration file. Uploading this configuration file replaces the current configuration file with the factory-default configuration file. This means that you will lose all previous configurations; the password will be reset to “1234” and the LAN IP address to 192.168.1.1.

To obtain the default configuration file, download it from the ZyXEL FTP site, unzip it and save it in a folder.

To upload the configuration file, follow the instructions in menu 24.6. For more information, refer to the *Firmware and Configuration File Maintenance* chapter.

All custom settings will be lost once you reset to the default settings.

3.4.2 Methods of Restoring Prestige Factory–Defaults

You can erase the current configuration and restore factory defaults in two ways:

1. Upload the default configuration file via Telnet as described above. Refer to *Chapter 8* in this User’s Guide for more information on how to transfer a configuration file to your Prestige using the SMT menus.

2. Use the **RESET** button on the rear panel of the Prestige (see *section 2.2.5*).

3.5 SMT Menu 1: General Setup

Menu 1 – General Setup contains administrative and system-related information.

To enter menu 1 and fill in the required information, follow these steps:

Step 1. Enter 1 in main menu to display **Menu 1 – General Setup**.

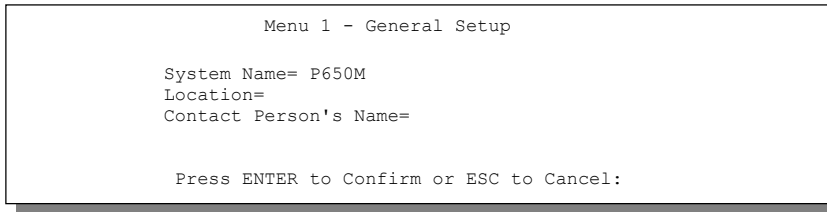

Figure 3-5 Menu 1–General Setup

Step 2. The **Menu 1 – General Setup** screen appears, as shown next. Fill in the fields following the explanation provided in the table shown next.

Table 3-3 General Setup Menu Fields

FIELD	DESCRIPTION	EXAMPLE
System Name	Choose a descriptive name for identification purposes. This name can be up to 30 alphanumeric characters long. Spaces are not allowed, but dashes "-" and underscores "_" are accepted.	Prestige
Location (optional)	Enter the geographic location (up to 31 characters) of your Prestige.	MyHouse
Contact Person's Name (optional)	Enter the name (up to 30 characters) of the person in charge of this Prestige.	JohnDoe

3.6 LANs and WANs

A LAN (Local Area Network) is a computer network limited to the immediate area, usually the same building or floor of a building. A WAN (Wide Area Network), on the other hand, is an outside connection to another network or the Internet.

3.6.1 LANs, WANs and the Prestige

The actual physical connection determines whether the Prestige ports are LAN or WAN ports. There are two separate IP networks, one inside, the LAN network; the other outside: the WAN network as shown next:

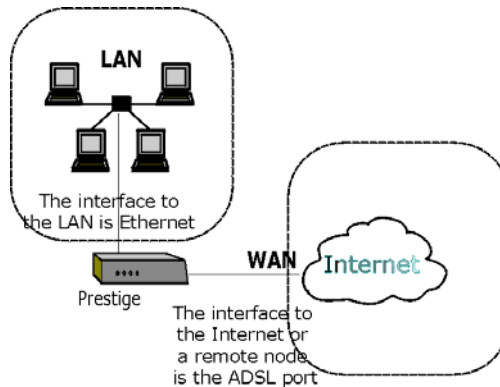

Figure 3-6 LAN & WAN IPs

3.6.2 IP Address and Subnet Mask

Like houses on a street that share a common street name, the computers on a LAN share one common network number.

Where you obtain your network number depends on your particular situation. If the ISP or your network administrator assigns you a block of registered IP addresses, follow their instructions in selecting the IP addresses and the subnet mask.

If the ISP did not explicitly give you an IP network number, then most likely you have a single user account and the ISP will assign you a dynamic IP address when the connection is established. If this is the case, it is recommended that you select a network number from 192.168.0.0 to 192.168.255.0 (ignoring the trailing zero) and you must enable the Single User Account feature of the Prestige. The Internet Assigned Number Authority (IANA) reserved this block of addresses specifically for private use; please do *not* use any other number unless you are told otherwise. Let's say you select 192.168.1.0 as the network number; which covers 254 individual addresses, from 192.168.1.1 to 192.168.1.254 (zero and 255 are reserved). In other words, the first three numbers specify the network number while the last number identifies an individual computer on that network.

The subnet mask specifies the network number portion of an IP address. Your Prestige will compute the subnet mask automatically based on the IP address that you entered. You don't need to change the subnet mask computed by the Prestige unless you are instructed to do otherwise.

3.7 SMT Menu 3: TCP/IP LAN Setup

The Ethernet parameters of the Prestige are preset in the factory with the following values:

IP address of 192.168.1.1 with subnet mask of 255.255.255.0 (24 bits).

Use menu 3.2 to configure the IP address of your Prestige. You need to do this to be able to manage your Prestige.

To edit menu 3.2, enter 3 from the main menu to display **Menu 3 – Ethernet Setup**. When menu 3 appears, press 2 and press [ENTER] to display **Menu 3.2 – TCP/IP and DHCP Ethernet Setup**, as shown next:

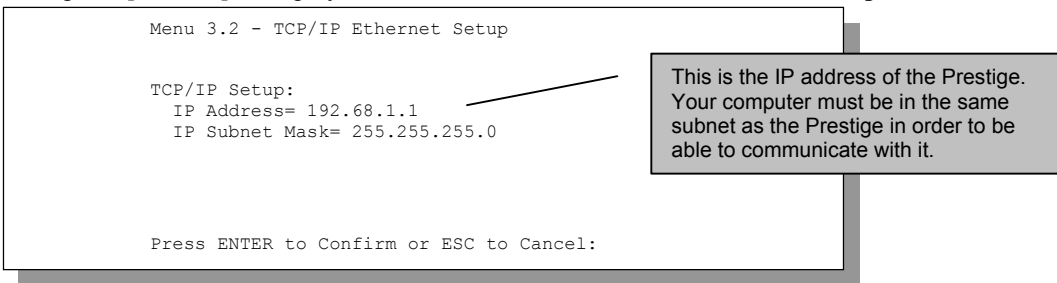

Figure 3-7 Menu 3.2 – TCP/IP and DHCP Ethernet Setup

Follow the instructions in the following table to configure TCP/IP parameters for the Ethernet port.

Table 3-4 TCP/IP Ethernet Setup Menu Fields

FIELD	DESCRIPTION	EXAMPLE
TCP/IP Setup		
IP Address	Enter the (LAN) IP address of your Prestige in dotted decimal notation	192.168.1.1
IP Subnet Mask	Your Prestige will automatically calculate the subnet mask based on the IP address that you assign. Unless you are implementing subnetting, use the subnet mask computed by the Prestige.	255.255.255.0
When you have completed this menu, press [ENTER] at the prompt “Press ENTER to Confirm...” to save your configuration, or press [ESC] at any time to cancel.		

Chapter 4

Internet Access

This chapter shows you how to configure your Prestige for Internet access.

4.1 Introduction

Menu 4 allows you to enter your Internet Access information in one screen. Menu 4 is actually a simplified setup for one of the remote nodes that you can access in menu 11. Before you configure your Prestige for Internet access, you need to collect your Internet account information from your ISP or telephone company.

Use the following table to record your Internet Account Information. Note that if you are using PPPoA encapsulation the only ISP information you need is a login name and password. If you are using RFC 1483, you do not need a login name or password.

Table 4-1 Internet Account Information

REQUIRED INFORMATION		
Virtual Path Identifier (VPI): _____		
Virtual Channel Identifier (VCI): _____		
Multiplexing (VC-based or LLC-based):	<input type="checkbox"/> VC	<input type="checkbox"/> LLC
Your device's WAN IP Address (if given): _____		
Encapsulation:		
<input type="checkbox"/> RFC 1483		
<input type="checkbox"/> PPPoA	User Name: _____	Password: _____

4.2 VPI and VCI

Be sure to use the correct Virtual Path Identifier (VPI) and Virtual Channel Identifier (VCI) numbers supplied by your ISP or telephone company. The valid range for the VPI is 0 to 255 and for the VCI is 32 to 65535 (0 to 31 is reserved for local management of ATM traffic). Please see the appendix on *Virtual Circuit Topology* for more information.

4.3 Multiplexing

There are two conventions to identify what protocols the virtual circuit (VC) is carrying. Be sure to use the multiplexing method required by your ISP.

4.3.1 VC-based Multiplexing

In this case, by prior mutual agreement, each protocol is assigned to a specific virtual circuit, for example, VC1 carries IP, etc. VC-based multiplexing may be dominant in environments where dynamic creation of large numbers of ATM VCs is fast and economical.

4.3.2 LLC-based Multiplexing

In this case one VC carries multiple protocols with protocol identifying information being contained in each packet header. Despite the extra bandwidth and processing overhead, this method may be advantageous if it is not practical to have a separate VC for each carried protocol, for example, if charging heavily depends on the number of simultaneous VCs.

4.4 Encapsulation

Be sure to use the encapsulation method required by your ISP. The Prestige supports the following methods.

4.4.1 PPPoA

Please refer to RFC 2364 for more information on PPP over ATM Adaptation Layer 5 (AAL5). Refer to RFC 1661 for more information on PPP.

4.4.2 RFC 1483

RFC 1483 describes two methods for Multiprotocol Encapsulation over ATM Adaptation Layer 5 (AAL5). The first method allows multiplexing of multiple protocols over a single ATM virtual circuit (LLC-based multiplexing) and the second method assumes that each protocol is carried over a separate ATM virtual circuit (VC-based multiplexing). Please refer to the RFC for more detailed information.

4.4.3 Encapsulation and Multiplexing Scenarios

For Internet access you should use the encapsulation and multiplexing methods used by your ISP. For LAN-to-LAN applications, e.g., branch office and corporate headquarters, prior agreement on methods is necessary because encapsulation and multiplexing cannot be automatically determined. Which methods to use depends on how many VCs you have and how many different network protocols you need. Here are some examples of more suitable combinations in such an application.

Scenario 1. One VC, Multiple Protocols

PPPoA (RFC-2364) encapsulation with **VC-based** multiplexing is the best combination because no extra protocol identifying headers are needed. The **PPPoA** protocol already contains this information.

Scenario 2. One VC, One Protocol (IP)

Selecting **RFC 1483** encapsulation with **VC-based** multiplexing requires the least amount of overhead (0 octets). However, if there is a potential need for multiple protocol support in the future, it may be safer to select **PPPoA** encapsulation instead of **RFC 1483**, so you do not need to reconfigure either computer later.

Scenario 3. Multiple VCs

If you have an equal number (or more) of VCs than the number of protocols, then select **RFC 1483** encapsulation and **VC-based** multiplexing.

4.4.4 Traffic Shaping

Traffic Shaping is an agreement between the carrier and the subscriber to regulate the average rate and “burstiness” or fluctuation of data transmission over an ATM network. This agreement helps eliminate congestion, which is important for transmission of real time data such as audio and video connections.

Peak Cell Rate (PCR) is the maximum rate at which the sender can send cells. This parameter may be lower (but not higher) than the maximum line speed. 1 ATM cell is 53 bytes (424 bits), so a maximum speed of 832 Kbps gives a maximum PCR of 1962 cells/sec. This rate is not guaranteed because it is dependent on the line speed.

Sustained Cell Rate (SCR) is the mean cell rate of a bursty, on-off traffic source that can be sent at the peak rate, and a parameter for burst-type traffic. SCR may not be greater than the PCR; the system default is 0 cells/sec.

Maximum Burst Size (MBS) is the maximum number of cells that can be sent at the PCR. After MBS is reached, cell rates fall below SCR until cell rate averages to the SCR again. At this time, more cells (up to the MBS) can be sent at the PCR again.

If the PCR, SCR or MBS is set to the default of “0”, the system will assign a maximum value that correlates to your upstream line rate.

The following figure illustrates the relationship between PCR, SCR and MBS.

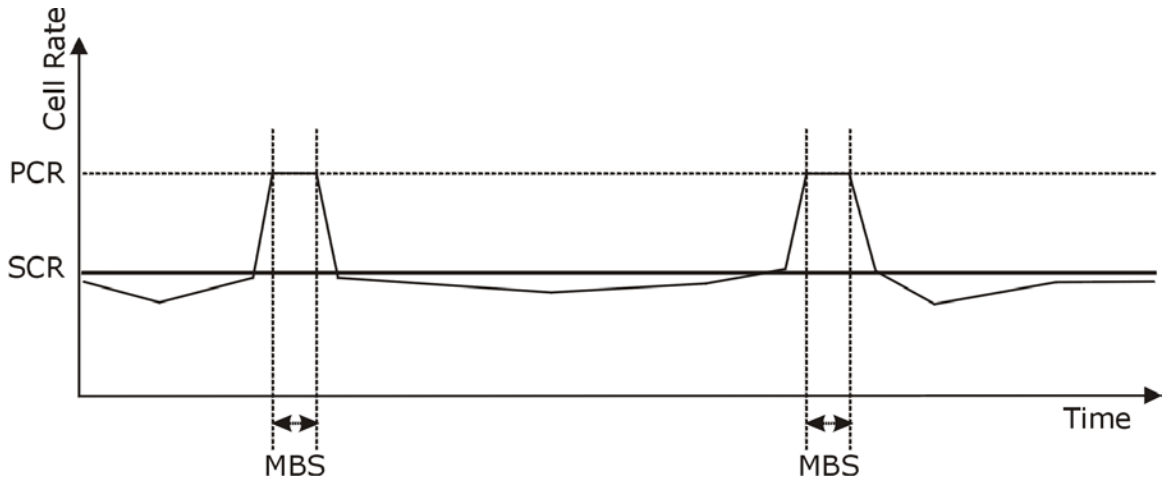

Figure 4-1 Example of Traffic Shaping

If the PCR is set to the default of “0”, the system will assign a maximum value that correlates to your upstream line rate.

4.5 Internet Access Configuration

From the main menu, enter 4 to display **Menu 4—Internet Access Setup**, as shown next.

```

Menu 4 - Internet Access Setup

ISP's Name= Change Me
Encapsulation= RFC 1483
Multiplexing= LLC-based
VPI #= 0
VCI #= 35
ATM QoS Type= UBR
    Peak Cell Rate (PCR)= 0
    Sustain Cell Rate (SCR)= 0
    Maximum Burst Size (MBS)= 0
My Login= N/A
My Password= N/A

Press ENTER to confirm or ESC to cancel:
    
```

Figure 4-2 Internet Access Setup

The following table contains instructions on how to configure your Prestige for Internet access.

Table 4-2 Internet Access Setup Menu Fields

FIELD	DESCRIPTION	EXAMPLE
ISP's Name	Enter the name of your Internet Service Provider. This information is for identification purposes only.	ChangeMe
Encapsulation	Press [SPACE BAR] to select the method of encapsulation used by your ISP. Choices are PPPoA or RFC 1483 .	RFC 1483
Multiplexing	Press [SPACE BAR] to select the method of multiplexing used by your ISP. Choices are VC-based or LLC-based .	LLC-based
VPI #	Enter the Virtual Path Identifier (VPI) that the telephone company gives you.	8
VCI #	Enter the Virtual Channel Identifier (VCI) that the telephone company gives you.	35
ATM QoS Type	Press [SPACE BAR] and select CBR (Continuous Bit Rate) to specify fixed (always-on) bandwidth. Select UBR (Unspecified Bit Rate) for applications that are non-time sensitive, such as e-mail. Select VBR (Variable Bit Rate) for bursty traffic and bandwidth sharing with other applications.	UBR
Peak Cell Rate (PCR)	This is the maximum rate at which the sender can send cells. Type the PCR.	0
Sustain Cell Rate (SCR)= 0	Sustained Cell Rate is the mean cell rate of a bursty, on-off traffic source that can be sent at the peak rate, and a parameter for burst-type traffic. Type the SCR; it must be less than the PCR.	0
Maximum Burst Size (MBS)= 0	Refers to the maximum number of cells that can be sent at the peak rate. Type the MBS. The MBS must be less than 65535.	0
My Login	Enter the login name that your ISP gives you.	N/A
My Password	Enter the password associated with the login name above.	N/A
When you have completed this menu, press [ENTER] at the prompt "Press ENTER to Confirm..." to save your configuration, or press [ESC] at any time to cancel.		

If all your settings are correct your Prestige should connect automatically to the Internet. If the connection fails, note the error message that you receive on the screen and take the appropriate troubleshooting steps.

Chapter 5

Remote Node Configuration

This chapter shows you how to set up a remote node.

5.1 Remote Node Setup

A remote node is required for placing calls to a remote gateway. A remote node represents both the remote gateway and the network behind it across a WAN connection. When you use menu 4 to set up Internet access, you are configuring one of the remote nodes.

5.1.1 Remote Node Profile

To configure a remote node, follow these steps:

Step 1. From the main menu, enter 11 to display **Menu 11-Remote Node Setup**.

Step 2. When menu 11 appears, as shown in the following figure, type the number of the remote node that you want to configure.

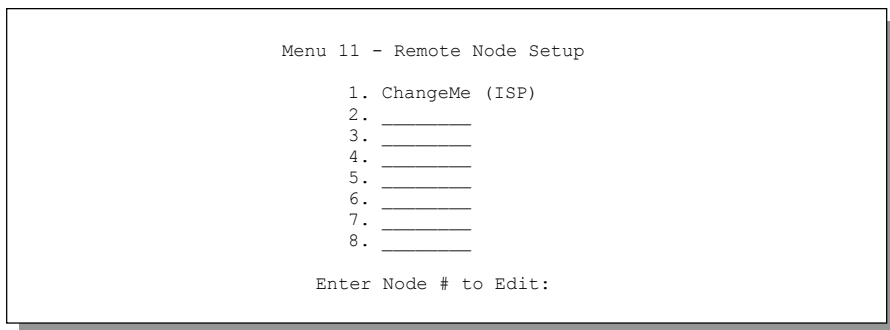

Figure 5-1 Menu 11-Remote Node Setup

Step 3. Choose a remote node to configure by entering a number from 1 to 8.

```

Menu 11.1 - Remote Node Profile

Rem Node Name= ChangeMe          Bridge:
Active= Yes                      Ethernet Addr Timeout(min)= 0
                                VPI #= 1
Encapsulation= RFC 1483          VCI #= 32
Multiplexing= LLC-based

                                ATM QoS Type= UBR
Incoming:                        Peak Cell Rate (PCR)= 0
  Rem Login= N/A                 Sustain Cell Rate (SCR)= 0
  Rem Password= N/A              Maximum Burst Size (MBS)= 0

Outgoing:
  My Login= N/A                  Filter Sets:
  My Password= N/A              Input Device Filters=
  Authen= N/A                   Output Device Filters=

                                Press ENTER to Confirm or ESC to Cancel:

```

Figure 5-2 Menu 11.1-Remote Node Profile

Fill in the fields as described in the following table. Please see *Chapter 4* for more background information.

Table 5-1 Remote Node Profile Menu Fields

FIELD	DESCRIPTION	EXAMPLE
Rem Node Name	Type a unique, descriptive name of up to eight characters for this node.	ChangeMe
Active	Press [SPACE BAR] and then [ENTER] to select Yes to activate or No to deactivate this node. Inactive nodes are displayed with a minus sign “-“ in SMT menu 11.	Yes
Encapsulation	PPPoA refers to RFC-2364 (PPP Encapsulation over ATM Adaptation Layer 5). If you select RFC 1483 (Multiprotocol Encapsulation over ATM Adaptation Layer 5) then Rem Login , Rem Password , My Login and My Password fields are not applicable (N/A).	RFC 1483
Multiplexing	Press [SPACE BAR] and then [ENTER] to select the method of multiplexing that your ISP uses, either VC-based or LLC-based .	LLC-based
Incoming:		
Rem Login	Type the login name that this remote node will use to call your Prestige. The login name and the Rem Password will be used to authenticate this node.	
Rem Password	Type the password used when this remote node calls your Prestige.	
Outgoing:		

Table 5-1 Remote Node Profile Menu Fields

FIELD	DESCRIPTION	EXAMPLE
My Login	Type the login name assigned by your ISP when the Prestige calls this remote node.	
My Password	Type the password assigned by your ISP when the Prestige calls this remote node.	
Authen	<p>We recommend you employ the strongest authentication protocol possible. However, some vendors' implementation includes a specific authentication protocol in the user profile. It will disconnect if the negotiated protocol is different from that in the user profile, even when the negotiated protocol is stronger than specified. If the peer disconnects right after a successful authentication, make sure that you specify the correct authentication protocol when connecting to such an implementation.</p> <p>This field sets the authentication protocol used for outgoing calls. Options for this field are:</p> <p>CHAP/PAP – Your Prestige will accept either CHAP or PAP when requested by this remote node.</p> <p>CHAP – accept CHAP (Challenge Handshake Authentication Protocol) only.</p> <p>PAP – accept PAP (Password Authentication Protocol) only.</p>	CHAP/PAP
Bridge:		
Ethernet Addr Timeout(min)	Type the time (in minutes) for the Prestige to retain the Ethernet Address information in its internal tables while the line is down. If this information is retained, your Prestige will not have to recompile the tables when the line comes back up.	0
VPI #	Enter the Virtual Path Identifier (VPI) that the ISP or telephone company gives you.	8
VCI #	Enter the Virtual Channel Identifier (VCI) that the ISP or telephone company gives you.	35
ATM QoS Type	Press [SPACE BAR] and select CBR (Continuous Bit Rate) to specify fixed (always-on) bandwidth. Select UBR (Unspecified Bit Rate) for applications that are non-time sensitive, such as e-mail.	UBR
Peak Cell Rate (PCR)	This is the maximum rate at which the sender can send cells. Type the PCR.	0
Sustain Cell Rate	Sustained Cell Rate is the mean cell rate of a bursty, on-off traffic	0

Table 5-1 Remote Node Profile Menu Fields

FIELD	DESCRIPTION	EXAMPLE
(SCR)= 0	source that can be sent at the peak rate, and a parameter for burst-type traffic. Type the SCR; it must be less than the PCR.	
Maximum Burst Size (MBS)= 0	Refers to the maximum number of cells that can be sent at the peak rate. Type the MBS. The MBS must be less than 65535.	0
Filter Sets:		
Input Device Filters	Apply filters for incoming traffic. See <i>Chapter 6</i> for information on filters.	
Output Device Filters	Apply filters for traffic leaving the Prestige. See <i>Chapter 6</i> for information on filters.	
When you have completed this menu, press [ENTER] at the prompt "Press ENTER to confirm or ESC to cancel" to save your configuration or press [ESC] to cancel and go back to the previous screen.		

Chapter 6

Filter Set Configuration

This chapter shows you how to create and apply filters.

6.1 About Filtering

Your Prestige uses filters to decide whether or not to allow passage of data packets. Data filtering examines the data to determine if the packet should be allowed to pass. Data filters are divided into incoming and outgoing filters, depending on the direction of the packet relative to a port.

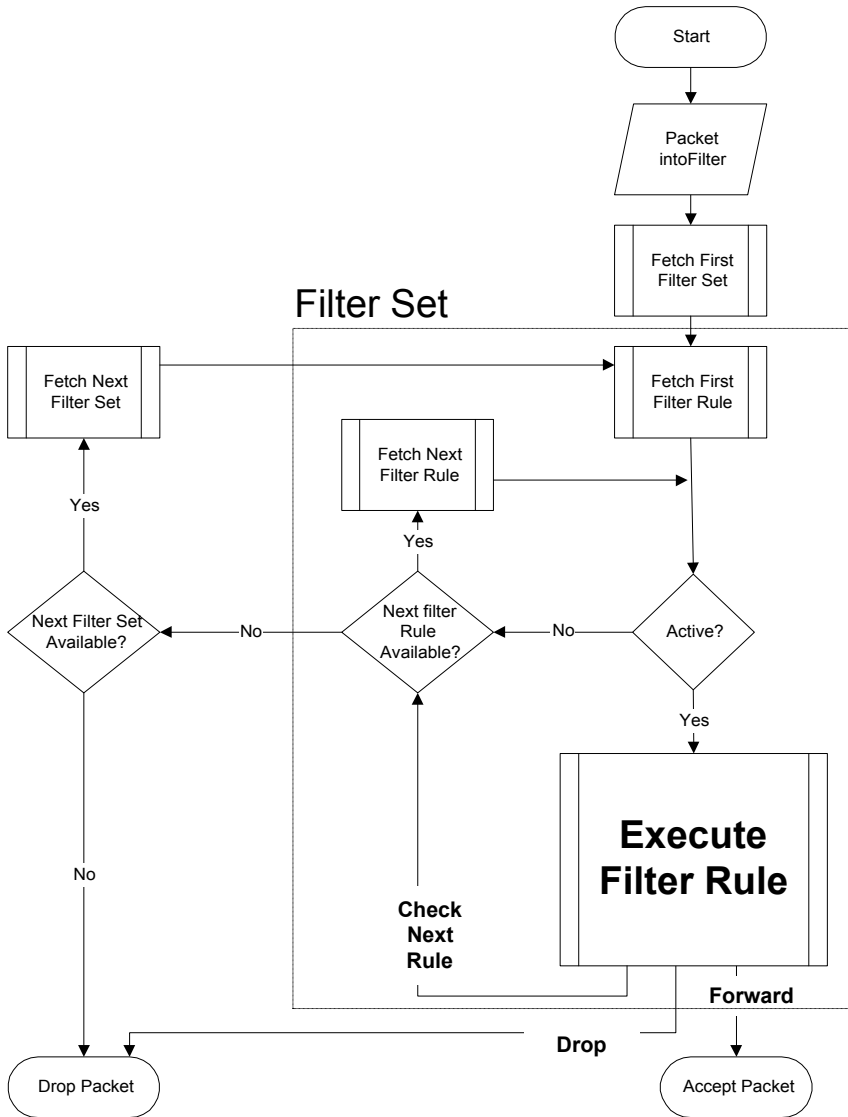

Figure 6-1 Filter Rule Process

You can apply up to four filter sets to a particular port to block various types of packets. Because each filter set can have up to six rules, you can have a maximum of 24 rules active for a single port.

6.2 Configuring a Filter Set

To configure a filter set, follow the steps shown next.

Step 1. Enter 21 in the main menu to display **Menu 21-Filter Set Configuration**

```

Menu 21 - Filter Set Configuration

Filter Set #      Comments                Filter Set #      Comments
-----
1                _____                7                _____
2                _____                8                _____
3                _____                9                _____
4                _____                10               _____
5                _____                11               _____
6                _____                12               _____

Enter Filter Set Number to Configure= 0

Edit Comments= N/A

Press ENTER to Confirm or ESC to Cancel:

```

Figure 6-2 Menu 21–Filter Set Configuration

Step 2. Type the filter set to configure (no. 1 to 12) and press [ENTER].

Step 3. Type a descriptive name or comment in the **Edit Comments** field and press [ENTER].

Step 4. Press [ENTER] at the message “Press ENTER to confirm...” to display **Menu 21.1–Filter Rules Summary** (that is, if you selected filter set 1 in menu 21).

```

Menu 21.1 - Filter Rules Summary

# A Type          Filter Rules                M m n
-----
1 N
2 N
3 N
4 N
5 N
6 N

Enter Filter Rule Number (1-6) to Configure:

```

Figure 6-3 Menu 21.1–Filter Rules Summary

6.2.1 Filter Rules Summary Menus

The following tables briefly describe the abbreviations used in menus 21.1 and 21.2.

Table 6-1 Abbreviations Used in the Filter Rules Summary Menu

FIELD	DESCRIPTION
#	The filter rule number: 1 to 6.
A	Active: "Y" means the rule is active. "N" means the rule is inactive.
Type	The type of filter rule: "GEN" for Generic
Filter Rules	These parameters are displayed here.
M	More. "Y" means there are more rules to check which form a rule chain with the present rule. An action cannot be taken until the rule chain is complete. "N" means there are no more rules to check. You can specify an action to be taken for instance, forward the packet, drop the packet or check the next rule. For the latter, the next rule is independent of the rule just checked.
m	Action Matched. "F" means to forward the packet immediately and skip checking the remaining rules. "D" means to drop the packet. "N" means to check the next rule.
n	Action Not Matched. "F" means to forward the packet immediately and skip checking the remaining rules. "D" means to drop the packet. "N" means to check the next rule.

Table 6-2 Rule Abbreviations Used

FILTER TYPE	DESCRIPTION
GEN	
Off	Offset
Len	Length

6.3 Generic Filter Rule

The purpose of generic rules is to allow you to filter non-IP packets. For generic rules, the Prestige treats a packet as a byte stream as opposed to an IP packet. You specify the portion of the packet to check with the Offset (from 0) and the Length fields, both in bytes. The Prestige applies the Mask (bit-wise ANDing) to

the data portion before comparing the result against the Value to determine a match. The Mask and Value are specified in hexadecimal numbers.

Two hexadecimal digits represent a byte, so if the length is 4, the value in either field will take 8 digits, e.g., FFFFFFFF.

6.3.1 Example Generic Filter Rule Configuration

- Step 1.** Type a filter set number in **Menu 21–Filter Set Configuration**, (“5” in this example), and press [ENTER] to display menu 21.5.
- Step 2.** Type a filter rule number in **Menu 21.5–Filter Rules Summary**, (“1” in this example), and press [ENTER] to display **Menu 21.5.1–Generic Filter Rule** (shown next).

```

Menu 21.5.1 - Generic Filter Rule

Filter #: 5,1

Active= No
Offset= 0
Length= 0
Mask= N/A
Value= N/A
More= No           Log= None
Action Matched= Check Next Rule
Action Not Matched= Check Next Rule

Press ENTER to Confirm or ESC to Cancel:

Press Space Bar to Toggle.

```

Figure 6-4 Menu 21.5.1–Generic Filter Rule

The table, shown next, describes the fields in **Menu 21.5.1 –Generic Filter Rule**.

Table 6-3 Menu 21.5.1 – Generic Filter Rule Fields

FIELD	DESCRIPTION	EXAMPLE
Filter #	This is the filter set, filter rule coordinates, for instance, 2, 3 refers to the second filter set and the third rule of that set.	5,1
Active	Select Yes to turn on or No to turn off the filter rule.	No
Offset	Type the starting byte of the data portion in the packet that you want to compare. The range for this field is from 0 to 255.	0
Length	Type the byte count of the data portion in the packet that you want to compare. The range for this field is 0 to 8.	0

Table 6-3 Menu 21.5.1 – Generic Filter Rule Fields

FIELD	DESCRIPTION	EXAMPLE
Mask	Type the mask (in Hexadecimal) to apply to the data portion before comparison.	
Value	Type the value (in Hexadecimal) to compare with the data portion.	
More	If Yes , a matching packet is passed to the next filter rule before an action is taken or else the packet is disposed of according to the action fields. If More is Yes , then Action Matched and Action Not Matched will be N/A .	No
Log	Select the logging option from the following: None – No packets will be logged. Action Matched – Only matching packets and rules will be logged. Action Not Matched – Only packets that do not match the rule parameters will be logged. Both – All packets will be logged.	None
Action Matched	Select the action for a matching packet. Choices are Check Next Rule , Forward or Drop .	Check Next Rule
Action Not Matched	Select the action for a packet not matching the rule. Choices are Check Next Rule , Forward or Drop .	Check Next Rule
When you have completed this menu, press [ENTER] at the prompt “Press ENTER to confirm or ESC to cancel” to save your configuration or press [ESC] to cancel and go back to the previous screen.		

6.4 Filter Configuration Example

Let us look at a sample filter.

- Step 1.** Enter 21 from the main menu to open **Menu 21-Filter Set Configuration**.
- Step 2.** Enter the index of the filter set you want to configure (in this case 3).
- Step 3.** Enter a descriptive name or comment in the **Edit Comments** field (in this case, test).
- Step 4.** Press [ENTER] at the message “Press ENTER to confirm or ESC to cancel” to open **Menu 21.3-Filter Rules Summary**.
- Step 5.** Enter 1 to configure the first filter rule. When you press [ENTER] to confirm, the following screen appears. Note that there is only one filter rule in this set. Make the entries in this menu as shown next.

Step 6. When you press [ENTER] to confirm, you will see the next screen. Note that there is only one filter rule in this set.

Menu 21.3 - Filter Rules Summary

#	A	Type	Filter Rules	M	m	n
1	Y	Gen	Off=9, Len=4, Mask=789abcde, Value=789abcde	N	F	D
2	N					
3	N					
4	N					
5	N					
6	N					

Enter Filter Rule Number (1-6) to Configure: 1

This shows what you configured in the previous menu.

M = N means an action can be taken immediately. The action is to drop the packet (**m = D**) if the action is matched and to forward the packet immediately (**n = F**) if the action is not matched no matter whether there are more rules to be checked (there are not in this example).

Figure 6-5 Sample Filter Rules Summary – Menu 21.3

6.5 Applying Filters

This section shows you where to apply the filters after you design them. Filter rules may be configured in menu 21.

Table 6-4 Filter Set Types

FILTER SETS	DESCRIPTION
Input Filter Sets:	Apply filters for incoming traffic. You may apply device filter rules. See earlier in this chapter for information on filters.
Output Filter Sets:	Apply filters for traffic leaving the Prestige. You may apply device filters. See earlier in this section for information on filters.

6.5.1 Remote Node Filters

Go to menu 11.1 (shown next) and type the number(s) of the filter set(s) as appropriate. You can cascade up to four filter sets by typing their numbers separated by commas.

```
Menu 11.1 - Remote Node Profile

Rem Node Name= Change Me      Bridge:
Active= Yes                   Ethernet Addr Timeout(min)= 0
                               VPI #= 0
Encapsulation= RFC 1483      VCI #= 33
Multiplexing= LLC-based      ATM QoS Type= CBR
Incoming:                    Peak Cell Rate (PCR)= 0
  Rem Login= N/A             Sustain Cell Rate (SCR)= 0
  Rem Password= N/A         Maximum Burst Size (MBS)= 0
Outgoing:
  My Login= N/A              Filter Sets:
  My Password= N/A          Input Device Filters=
  Authen= N/A               Output Device Filters=

Press ENTER to Confirm or ESC to Cancel:
```

Figure 6-6 Filtering Remote Node Traffic

Chapter 7

System Information and Diagnosis

This chapter covers the information and diagnostic tools in SMT menus 24.1 to 24.4 and 24.8.

7.1 Introduction

These menus display system status, port status and use of diagnostic tools when problems occur and an introduction to the command interface.

Enter 24 in the main menu to display **Menu 24 – System Maintenance**, shown next.

```
Menu 24 - System Maintenance

1. System Status
2. System Information and Console Port Speed
4. Diagnostic
5. Backup Configuration
6. Restore Configuration
7. Upload Firmware
8. Command Interpreter Mode

Enter Menu Selection Number:
```

Figure 7-1 Menu 24 – System Maintenance

7.2 System Status

System Status displays status and statistics of the Prestige. **Menu 24.1 – System Maintenance – Status** is meant for diagnostic purposes.

From the main menu, enter 24 to display **Menu 24 – System Maintenance**. Enter 1 to display **Menu 24.1 – System Maintenance – Status**, shown next.

```

Menu 24.1 - System Maintenance - Status                                01:30:36
                                                                    Thu. Oct. 30, 2002

Node-Lnk Status      TxPkts      RxPkts      Errors Tx B/s  Rx B/s      Up Time
1-1483  N/A          0           0           0     0/0      0/0        0:00:00
2       N/A          0           0           0     0/0      0/0        0:00:00
3       N/A          0           0           0     0/0      0/0        0:00:00
4       N/A          0           0           0     0/0      0/0        0:00:00
5       N/A          0           0           0     0/0      0/0        0:00:00
6       N/A          0           0           0     0/0      0/0        0:00:00
7       N/A          0           0           0     0/0      0/0        0:00:00
8       N/A          0           0           0     0/0      0/0        0:00:00

My WAN IP (from ISP): 0.0.0.0

Ethernet:
  Status: 100M/Full Duplex Tx Pkts: 483   Line Status: Wait for Init
  Collisions: 0             Rx Pkts: 581   Upstream Speed: 0 kbps
  CPU Load = 2.76%         Downstream Speed: 0 kbps

                          Press Command:
COMMANDS: 1-Reset Counters  ESC-Exit
    
```

Figure 7-2 Menu 24.1 – System Maintenance – Status

The following table describes the fields present in **Menu 24.1 – System Maintenance – Status**.

Table 7-1 System Maintenance – Status Menu Fields

FIELD	DESCRIPTION
Node-Lnk	This is the node index number and link type. Link types are: PPPoA and 1483 .
Status	This is the status of the remote node.
TxPkts	This is the number of transmitted packets to this remote node.
RxPkts	This is the number of received packets from this remote node.
Errors	This is the number of error packets on this connection.
Tx B/s	This is the transmission rate in bytes per second.
Rx B/s	This is the receiving rate in bytes per second.
Up Time	This is the time this channel has been connected to the current remote node.
My WAN IP (from ISP)	This is the WAN IP address you entered from your ISP.
Ethernet	This is the statistics for the LAN.
Status	This is the current status of the LAN.
Collisions	This is the number of collisions.

Table 7-1 System Maintenance – Status Menu Fields

FIELD	DESCRIPTION
Tx Pkts	This is the number of transmitted packets to the LAN.
Rx Pkts	This is the number of received packets from the LAN.
CPU Load	This specifies the percentage of CPU utilization.
WAN	This is the statistics for the WAN.
Line Status	This is the current status of the xDSL line which can be Up or Down .
Upstream Speed	This is the current upstream rate.
Downstream Speed	Shows the current downstream rate.
Commands	
1	Enter 1 to reset the counters
ESC	Press [ESC] to display the previous screen.

7.3 System Information and Console Port Speed

This section describes your system and allows you to choose different console port speeds. To display the **System Information and Console Port Speed** menu, follow the steps shown next.

Step 1. Enter 24 to display **Menu 24 – System Maintenance**.

Step 2. Enter 2 to display **Menu 24.2 – System Information and Console Port Speed**.

Step 3. From this menu you have two choices as shown in the next figure:

```

Menu 24.2 - System Information and Console Port Speed
  1. System Information
  2. Console Port Speed

Please enter selection:

```

Figure 7-3 Menu 24.2 – System Information and Console Port Speed

7.3.1 System Information

Enter 1 in menu 24.2 to display the screen shown next.

```

Menu 24.2.1 - System Maintenance - Information

Name: P650M
Routing: BRIDGE
ZyNOS F/W Version: V3.40(kk.o)b1 | 1/17/2003
ADSL Chipset Vendor: Alcatel, Version 4.9.10
Standard: Multi-Mode

LAN
Ethernet Address: 00:a0:c5:01:23:45
IP Address: 192.168.1.1
IP Mask: 255.255.255.0
DHCP: None

Press ESC or RETURN to Exit:
    
```

Figure 7-4 Menu 24.2.1 – System Maintenance – Information

Table 7-2 Fields in System Maintenance

FIELD	DESCRIPTION
Name	This field displays the system name of your Prestige. This information can be changed in Menu 1 – General Setup .
Routing	This field shows the kind of routing used by the Prestige.
ZyNOS F/W Version	This field displays the ZyNOS (ZyXEL Network Operating System) system firmware version. ZyNOS is a registered trademark of ZyXEL Communications Corporation.
ADSL Chipset Vendor	This is the chipset used in the Prestige.
Version	This field displays the ADSL Chipset version.
Standard	This refers to the operational protocol the Prestige and the DSLAM (Digital Subscriber Line Access Multiplexer) are using.
LAN	
Ethernet Address	This field displays to the Ethernet MAC (Media Access Control) of your Prestige.
IP Address	This is the IP address of the Prestige in dotted decimal notation.
IP Mask	This shows the subnet mask of the Prestige.
DHCP	This field shows the DHCP setting of the Prestige.

7.3.2 Console Port¹ Speed

You can set up different port speeds for the console port through **Menu 24.2.2 – System Maintenance – Console Port Speed**. Your Prestige supports 9600 (default), 19200, 38400 and 57600bps console port speeds.

Enter 2 in menu 24.2 to display the screen shown next. Press [SPACE BAR] and then [ENTER] to select the desired speed in menu 24.2.2, as shown in the following figure.

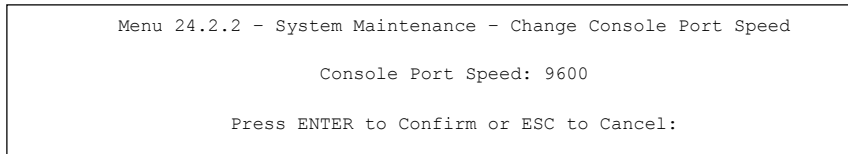

Figure 7-5 Menu 24.2.2 – System Maintenance – Change Console Port Speed

After you changed the console port speed on your Prestige, you must also make the same change to the console port speed parameter of your communication software.

7.4 Diagnostic

The diagnostic facility allows you to test the different aspects of your Prestige to determine if it is working properly. Menu 24.4 allows you to choose among various types of diagnostic tests to evaluate your system. Follow the procedure next display menu 24.4.

- Step 1.** From the main menu, enter 24 to display **Menu 24 – System Maintenance**.
- Step 2.** Enter 4 to display **Menu 24.4 – System Maintenance – Diagnostic**, shown next.

¹ The console port is inside this product and is for advanced troubleshooting purposes only. Do **not** open the device to access the console port as this will void your warranty.

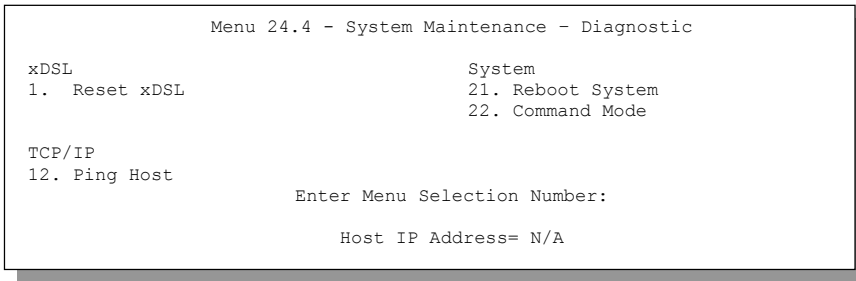

Figure 7-6 Menu 24.4 – System Maintenance – Diagnostic

The following table describes the diagnostic tests available in menu 24.4 for and the connections.

Table 7-3 System Maintenance Menu – Diagnostic

FIELD	DESCRIPTION
Reset xDSL	Type 1 to re-initialize the xDSL link to the telephone company.
Reboot System	Type 21 to reboot the Prestige.
Ping Host	Enter 12, enter the IP address of the host in the Host IP Address field and then press [ENTER] to ping a host IP address.
Host IP Address	Enter the host IP address that you want to ping.
Command Mode	Type 22 to test and diagnose your Prestige in command interpreter mode.

7.5 Command Interpreter Mode

The Command Interpreter (CI) is primarily for advanced users only, featuring some low-level setup and diagnostic functions.

See the included disk or the zyxel.com web site for more detailed information on CI commands.

Enter 8 from **Menu 24 – System Maintenance** or 22 from menu 22.4. A list of valid commands can be found by typing `help` or `?` at the command prompt. Type “exit” to return to the SMT main menu when finished.

```
Menu 24 - System Maintenance

1. System Status
2. System Information and Console Port Speed
4. Diagnostic
5. Backup Configuration
6. Restore Configuration
7. Firmware Update
8. Command Interpreter Mode

Enter Menu Selection Number:
```

Figure 7-7 Command Mode in Menu 24

```
Copyright (c) 1994 - 2003 ZyXEL Communications Corp.
P650M> ?
Valid commands are:
sys          exit          ether        wan
ip          bridge
P650M>
```

Figure 7-8 Valid Commands

Chapter 8

Firmware and Configuration File Maintenance

This chapter shows you how to back up and restore your configuration file as well as upload new firmware and a new configuration file.

8.1 Identifying Your Product

Look at the bottom of your product for a label that contains the product name. If you're looking for new firmware, you should first look for firmware of this exact name, including the suffix, for example P650M-31.

If you're unsure of the name or can't find the exact firmware name, please contact customer support or your vendor.

8.2 Filename Conventions

The configuration file (often called the romfile or rom-0) contains the factory default settings in the menus such as password, DHCP Setup, TCP/IP Setup, etc. It arrives from ZyXEL with a "rom" filename extension. Once you have customized the Prestige's settings, they can be saved back to your computer under a filename of your choosing.

ZyNOS (ZyXEL Network Operating System sometimes referred to as the "ras" file) is the system firmware and has a "bin" filename extension. With many FTP and TFTP clients, the filenames are similar to those seen next.

```
ftp> put firmware.bin ras
```

This is a sample FTP session showing the transfer of the computer file " firmware.bin" to the Prestige.

```
ftp> get rom-0 config.cfg
```

This is a sample FTP session saving the current configuration to the computer file "config.cfg".

If your (T)FTP client does not allow you to have a destination filename different than the source, you will need to rename them as the Prestige only recognizes "rom-0" and "ras". Be sure you keep unaltered copies of both files for later use.

The following table is a summary. Please note that the internal filename refers to the filename on the Prestige and the external filename refers to the filename not on the Prestige, that is, on your computer, local

network or FTP site and so the name (but not the extension) may vary. After uploading new firmware, see the **ZyNOS F/W Version** field in **Menu 24.2.1 – System Maintenance – Information** to confirm that you have uploaded the correct firmware version.

Table 8-1 Filename Conventions

FILE TYPE	INTERNAL NAME	EXTERNAL NAME	DESCRIPTION
Configuration File	Rom-0	This is the configuration filename on the Prestige. Uploading the rom-0 file replaces the entire ROM file system, including your Prestige configurations, system-related data (including the default password), the error log and the trace log.	*.rom
Firmware	Ras	This is the generic name for the ZyNOS firmware on the Prestige.	*.bin

8.3 Backup Configuration

The Prestige displays messages explaining how to backup, restore and upload files via Telnet in menus 24.5, 24.6, 24.7.1 and 24.7.2.

Enter 5 from **Menu 24 - System Maintenance** to backup the current Prestige configuration on your computer. Backup is highly recommended once your Prestige is functioning properly. FTP is the preferred methods for backing up your current configuration to your computer since it is fastest. Any serial communications program should work fine; however, you must use Xmodem protocol to perform the download/upload and you don't have to rename the files.

Please note that terms “download” and “upload” are relative to the computer. Download means to transfer from the Prestige to the computer, while upload means from your computer to the Prestige.

8.3.1 Backup Configuration

Follow the instructions as shown in the next screen.

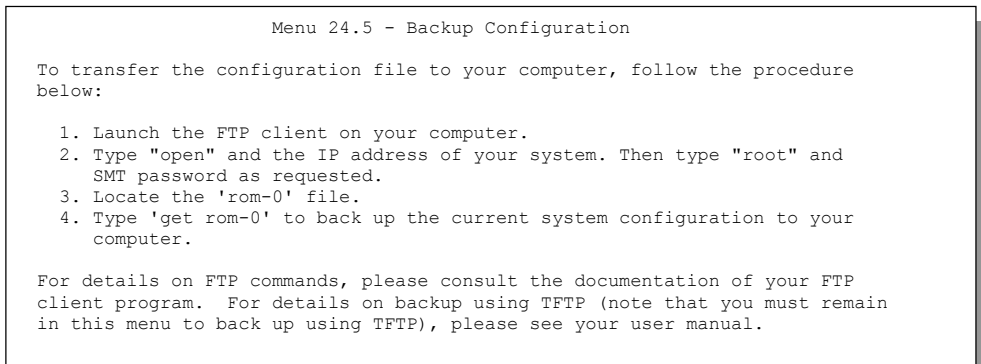

Figure 8-1 Telnet in Menu 24.5

8.3.2 Using the FTP Command from the Command Line

- Step 1.** Launch the FTP client on your computer.
- Step 2.** Enter “open”, followed by a space and the IP address of your Prestige.
- Step 3.** Press [ENTER] when prompted for a username.
- Step 4.** Enter your password as requested (the default is “1234”).
- Step 5.** Enter “bin” to set transfer mode to binary.
- Step 6.** Use “get” to transfer files from the Prestige to the computer, for example, “get rom-0 config.rom” transfers the configuration file on the Prestige to your computer and renames it “config.rom”. See earlier in this chapter for more information on filename conventions.
- Step 7.** Enter “quit” to exit the ftp prompt.

8.3.3 Example FTP Commands

```

331 Enter PASS command
Password:
230 Logged in
ftp> bin
200 Type I OK
ftp> get rom-0 zyxel.rom
200 Port command okay
150 Opening data connection for STOR ras
226 File received OK
ftp: 16384 bytes sent in 1.10Seconds 297.89Kbytes/sec.
ftp> quit
    
```

Figure 8-2 FTP Session Example

8.3.4 GUI-based FTP Clients

The following table describes some of the commands that you may see in GUI-based FTP clients.

Table 8-2 General Commands for GUI-based FTP Clients

COMMAND	DESCRIPTION
Host Address	Enter the address of the host server.
Login Type	Anonymous. This is when a user I.D. and password is automatically supplied to the server for anonymous access. Anonymous logins will work only if your ISP or service administrator has enabled this option. Normal. The server requires a unique User ID and Password to login.
Transfer Type	Transfer files in either ASCII (plain text format) or in binary mode.
Initial Remote Directory	Specify the default remote directory (path).
Initial Local Directory	Specify the default local directory (path).

8.3.5 Backup Configuration Using TFTP

The Prestige supports the up/downloading of the firmware and the configuration file using TFTP (Trivial File Transfer Protocol) over LAN. Although TFTP should work over WAN as well, it is not recommended.

To use TFTP, your computer must have both telnet and TFTP clients. To backup the configuration file, follow the procedure shown next.

- Step 1.** Use Telnet from your computer to connect to the Prestige and log in. Because TFTP does not have any security checks, the Prestige records the IP address of the telnet client and accepts TFTP requests only from this address.
- Step 2.** Put the SMT in command interpreter (CI) mode by entering 8 in **Menu 24 - System Maintenance**.
- Step 3.** Enter command “sys stdio 0” to disable the SMT timeout, so the TFTP transfer will not be interrupted. Enter command “sys stdio 5” to restore the five-minute SMT timeout (default) when the file transfer is complete.
- Step 4.** Launch the TFTP client on your computer and connect to the Prestige. Set the transfer mode to binary before starting data transfer.
- Step 5.** Use the TFTP client (see the example below) to transfer files between the Prestige and the computer. The file name for the configuration file is “rom-0” (rom-zero, not capital o).

Note that the telnet connection must be active and the SMT in CI mode before and during the TFTP transfer. For details on TFTP commands (see following example), please consult the documentation of your TFTP client program. For UNIX, use “get” to transfer from the Prestige to the computer and “binary” to set binary transfer mode.

8.3.6 TFTP Command Example

The following is an example TFTP command:

```
tftp [-i] host get rom-0 config.rom
```

where “i” specifies binary image transfer mode (use this mode when transferring binary files), “host” is the Prestige IP address, “get” transfers the file source on the Prestige (rom-0, name of the configuration file on the Prestige) to the file destination on the computer and renames it config.rom.

8.3.7 GUI-based TFTP Clients

The following table describes some of the fields that you may see in GUI-based TFTP clients.

Table 8-3 General Commands for GUI-based TFTP Clients

COMMAND	DESCRIPTION
Host	Enter the IP address of the Prestige. 192.168.1.1 is the Prestige’s default IP address when shipped.
Send/Fetch	Use “Send” to upload the file to the Prestige and “Fetch” to back up the file on your computer.
Local File	Enter the path and name of the firmware file (*.bin extension) or configuration file (*.rom extension) on your computer.

Table 8-3 General Commands for GUI-based TFTP Clients

COMMAND	DESCRIPTION
Remote File	This is the filename on the Prestige. The filename for the firmware is "ras" and for the configuration file, is "rom-0".
Binary	Transfer the file in binary mode.
Abort	Stop transfer of the file.

8.4 Restore Configuration

This section shows you how to restore a previously saved configuration. Note that this function erases the current configuration before restoring a previous back up configuration; please do not attempt to restore unless you have a backup configuration file stored on disk.

FTP is the preferred method for restoring your current computer configuration to your Prestige since FTP is faster. Please note that you must wait for the system to automatically restart after the file transfer is complete.

WARNING!
**DO NOT INTERRUPT THE FILE TRANSFER PROCESS AS THIS MAY
PERMANENTLY DAMAGE YOUR PRESTIGE.**

8.4.1 Restore Using FTP

For details about backup using (T)FTP please refer to earlier sections on FTP and TFTP file upload in this chapter.

```
Menu 24.6 - System Maintenance - Restore Configuration

To transfer the firmware and configuration file to your workstation, follow the procedure
below:

1. Launch the FTP client on your computer.
2. Type "open" and the IP address of your system. Then type "root" and
   SMT password as requested.
3. Type "put backupfilename rom-0" where backupfilename is the name of
   your backup configuration file on your workstation and rom-0 is the
   remote file name on the system. This restores the configuration to
   your system.
4. The system reboots automatically after a successful file transfer

For details on FTP commands, please consult the documentation of your FTP
client program. For details on backup using TFTP (note that you must remain
in this menu to back up using TFTP), please see your user manual.
```

Figure 8-3 Telnet into Menu 24.6

- Step 1.** Launch the FTP client on your computer.
- Step 2.** Enter “open”, followed by a space and the IP address of your Prestige.
- Step 3.** Press [ENTER] when prompted for a username.
- Step 4.** Enter your password as requested (the default is “1234”).
- Step 5.** Enter “bin” to set transfer mode to binary.
- Step 6.** Find the “rom” file (on your computer) that you want to restore to your Prestige.
- Step 7.** Use “put” to transfer files from the Prestige to the computer, for example, “put config.rom rom-0” transfers the configuration file “config.rom” on your computer to the Prestige. See earlier in this chapter for more information on filename conventions.
- Step 8.** Enter “quit” to exit the ftp prompt. The Prestige will automatically restart after a successful restore process.

8.4.2 Restore Using FTP Session Example

```
ftp> put config.rom rom-0
200 Port command okay
150 Opening data connection for STOR rom-0
226 File received OK
221 Goodbye for writing flash
ftp: 16384 bytes sent in 0.06Seconds 273.07Kbytes/sec.
ftp>quit
```

Figure 8-4 Restore Using FTP Session Example

8.5 Uploading Firmware and Configuration Files

This section shows you how to upload firmware and configuration files. You can upload configuration files by following the procedure in the previous *Restore Configuration* section or by following the instructions in **Menu 24.7.2 - System Maintenance - Upload System Configuration File**.

WARNING!
**DO NOT INTERRUPT THE FILE TRANSFER PROCESS AS THIS MAY
PERMANENTLY DAMAGE YOUR PRESTIGE.**

8.5.1 Firmware File Upload

FTP is the preferred method for uploading the firmware and configuration. To use this feature, your computer must have an FTP client.

When you telnet into the Prestige, you will see the following screens for uploading firmware and the configuration file using FTP.

```
Menu 24.7.1 - System Maintenance - Upload System Firmware

To upload the system firmware, follow the procedure below:

1. Launch the FTP client on your computer.
2. Type "open" and the IP address of your system. Then type "root" and
   SMT password as requested.
3. Type "put firmwarefilename ras" where "firmwarefilename" is the name
   of your firmware upgrade file on your workstation and "ras" is the
   remote file name on the system.
4. The system reboots automatically after a successful firmware upload.

For details on FTP commands, please consult the documentation of your FTP
client program. For details on uploading system firmware using TFTP (note
that you must remain on this menu to upload system firmware using TFTP),
please see your manual.

Press ENTER to Exit:
```

Figure 8-5 Telnet Into Menu 24.7.1 - Upload System Firmware

8.5.2 Configuration File Upload

You see the following screen when you telnet into menu 24.7.2.

```
Menu 24.7.2 - System Maintenance - Upload System Configuration File

To upload the system configuration file, follow the procedure below:

1. Launch the FTP client on your computer.
2. Type "open" and the IP address of your system. Then type "root" and
   SMT password as requested.
3. Type "put configurationfilename rom-0" where "configurationfilename"
   is the name of your system configuration file on your workstation, which
   will be transferred to the "rom-0" file on the system.
4. The system reboots automatically after the upload system configuration
   file process is complete.

For details on FTP commands, please consult the documentation of your FTP
client program. For details on uploading system firmware using TFTP (note
that you must remain on this menu to upload system firmware using TFTP),
please see your manual.

Press ENTER to Exit:
```

Figure 8-6 Telnet Into Menu 24.7.2 - System Maintenance

To upload the firmware and the configuration file, follow these examples

8.5.3 FTP File Upload Command from the DOS Prompt Example

- Step 1.** Launch the FTP client on your computer.
- Step 2.** Enter “open”, followed by a space and the IP address of your Prestige.
- Step 3.** Press [ENTER] when prompted for a username.
- Step 4.** Enter your password as requested (the default is “1234”).
- Step 5.** Enter “bin” to set transfer mode to binary.
- Step 6.** Use “put” to transfer files from the computer to the Prestige, for example, “put firmware.bin ras” transfers the firmware on your computer (firmware.bin) to the Prestige and renames it “ras”. Similarly, “put config.rom rom-0” transfers the configuration file on your computer (config.rom) to the Prestige and renames it “rom-0”. Likewise “get rom-0 config.rom” transfers the configuration file on the Prestige to your computer and renames it “config.rom.” See earlier in this chapter for more information on filename conventions.
- Step 7.** Enter “quit” to exit the ftp prompt.

8.5.4 FTP Session Example of Firmware File Upload

```
331 Enter PASS command
Password:
230 Logged in
ftp> bin
200 Type I OK
ftp> put firmware.bin ras
200 Port command okay
150 Opening data connection for STOR ras
226 File received OK
ftp: 1103936 bytes sent in 1.10Seconds 297.89Kbytes/sec.
ftp> quit
```

Figure 8-7 FTP Session Example of Firmware File Upload

More commands (found in GUI-based FTP clients) are listed earlier in this chapter.

8.5.5 TFTP File Upload

The Prestige also supports the uploading of firmware files using TFTP (Trivial File Transfer Protocol) over LAN. Although TFTP should work over WAN as well, it is not recommended.

To use TFTP, your computer must have both telnet and TFTP clients. To transfer the firmware and the configuration file, follow the procedure shown next.

- Step 1.** Use telnet from your computer to connect to the Prestige and log in. Because TFTP does not have any security checks, the Prestige records the IP address of the telnet client and accepts TFTP requests only from this address.
- Step 2.** Put the SMT in command interpreter (CI) mode by entering 8 in **Menu 24 - System Maintenance**.
- Step 3.** Enter the command “sys stdio 0” to disable the timeout, so the TFTP transfer will not be interrupted. Enter “command sys stdio 5” to restore the five-minute timeout (default) when the file transfer is complete.
- Step 4.** Launch the TFTP client on your computer and connect to the Prestige. Set the transfer mode to binary before starting data transfer.
- Step 5.** Use the TFTP client (see the example below) to transfer files between the Prestige and the computer. The file name for the firmware is “ras”.

Note that the telnet connection must be active and the Prestige in CI mode before and during the TFTP transfer. For details on TFTP commands (see following example), please consult the documentation of your TFTP client program. For UNIX, use “get” to transfer from the Prestige to the computer, “put” the other way around, and “binary” to set binary transfer mode.

8.5.6 TFTP Upload Command Example

The following is an example TFTP command:

```
tftp [-i] host put firmware.bin ras
```

where “i” specifies binary image transfer mode (use this mode when transferring binary files), “host” is the Prestige’s IP address and “put” transfers the file source on the computer (firmware.bin – name of the firmware on the computer) to the file destination on the remote host (ras - name of the firmware on the Prestige).

Commands that you may see in GUI-based TFTP clients are listed earlier in this chapter.

Chapter 9

Troubleshooting

This chapter covers potential problems and possible corresponding remedies.

9.1 Problems Starting the Prestige

Table 9-1 Problems Starting the Prestige

PROBLEM	CORRECTIVE ACTION
No LEDs are on when the Prestige is turned on.	<p>Make sure that the Prestige's power adapter is connected to the Prestige and plugged in to an appropriate power source.</p> <p>Make sure the Ethernet device connected to the LAN port is on and working properly.</p> <p>Turn the Prestige off and on again.</p> <p>If error persists, it may be a hardware problem. Contact technical support.</p>

9.2 Power Problems

Table 9-2 Problems With the Power Source

PROBLEM	CORRECTIVE ACTION
The SYS LED is red.	<p>Prestige power is low and consequently may be disconnected from the DSL line. This is a "dying gasp" warning signal.</p> <p>Make sure you are using the correct power adapter.</p> <p>Make sure you have sufficient power for the operation of your Prestige. Make sure you do not have too many electrical appliances connected to the same power source.</p> <p>Check the power connections between the Prestige and your power source.</p>

9.3 Problems Connecting to the LAN

Table 9-3 Problems Connecting with the LAN

PROBLEM	CORRECTIVE ACTION
Cannot ping any computer on the LAN.	<p>Check the LAN LEDs on the front panel. The LAN LED should be on if a computer is connected. If it is off, check the cables between your Prestige and the computer.</p> <p>Make sure your computer NIC (Network Interface Card) is working properly.</p> <p>Check the TCP/IP configuration on your computer. Make sure that the IP address and the subnet mask of the Prestige and the LAN computer(s) are on the same subnet.</p>
Cannot access the Prestige from the LAN	<p>If the all the LAN LEDs on the front panel are off, check the Ethernet cable connection between your Prestige and the computer connected to the LAN port.</p> <p>Check for faulty Ethernet cables. Make sure the distance between the computer and your Prestige does not exceed 100 meters if the computer is connected directly to the Prestige.</p> <p>Make sure the NIC (Network Interface Card) on the Ethernet device is installed and working properly.</p> <p>Check the IP address of the Ethernet device. Make sure that the IP address and the subnet mask of the Prestige and the Ethernet device are on the same subnet.</p> <p>The default IP address is "192.168.1.1". If you have changed the IP address and have now forgotten it, you will need to upload the default configuration file or reset the device.</p>

9.4 Problems Connecting with the WAN or Remote Node/ISP

Table 9-4 Problems Connecting with the WAN or Remote Node/ISP

PROBLEM	CORRECTIVE ACTION
Cannot initialize the PVC connection.	<p>Verify the DSL port/wall jack cable connection. The DSL LED should be on. If not, verify in menu 24.1 that the Line Status field reads Down. Wait 10 minutes until the PVC synchronizes and the field reads Up.</p> <p>If problems persist, check with the telephone company, ISP and/or the peer modem (in a LAN-to-LAN application).</p>
Cannot connect to a remote node or ISP.	<p>Check menu 4 or menu 11.1 to verify the Encapsulation, Multiplexing, VPI, VCI, Login name and Password for the remote node.</p>

9.5 Problems Accessing the SMT Menu

Table 9-5 Problems Accessing SMT Menus

PROBLEM	CORRECTIVE ACTION
I cannot access the SMT menu.	The default SMT password is "1234". If you have changed the password and have now forgotten it, you will need to upload the default configuration file.

9.6 Problems Accessing the Internet

Table 9-6 Problems Accessing the Internet

PROBLEM	CORRECTIVE ACTION
I cannot access the Internet.	<p>Make sure the Prestige is turned on and connected to the network.</p> <p>If the Prestige's DSL LED is off, check the cable between the Prestige and the telephone wall jack.</p> <p>Make sure you entered your user name correctly. A user name may be case-sensitive.</p>
The DSL LED is off.	Check the connection between the Prestige DSL port and the wall jack.

Appendix A

Power Adapter Specifications

NORTH AMERICA PLUG STANDARDS	
AC Power Adapter model	DV-121AACS
Input power	AC120Volts/60Hz/23W max.
Output power	AC12Volts/1.0A
Power consumption	8 W
Safety standards	UL, CUL (UL 1310, CSA C22.2 No.223)
NORTH AMERICA PLUG STANDARDS	
AC Power Adapter model	AA-121A
Input power	AC120Volts/60Hz/18W max.
Output power	AC12Volts/1.0A
Power consumption	8 W
Safety standards	UL, CUL (UL 1310, CSA C22.2 No.223)
CHINESE PLUG STANDARDS	
AC Power Adapter model	DV-121AACCP-5720
Input power	AC220Volts/50Hz/18W
Output power	AC12Volts/1.0A
Power consumption	8 W
Safety standards	CCEE (GB8898)
EUROPEAN PLUG STANDARDS	
AC Power Adapter model	AA-121ABN
Input power	AC230Volts/50Hz/140mA
Output power	AC12Volts/1.0A
Power consumption	8 W
Safety standards	ITS-GS, CE (EN 60950)

EUROPEAN PLUG STANDARDS

AC Power Adapter model	DV-121AACCP-5716
Input power	AC230Volts/50Hz/100mA
Output power	AC12Volts/1.0A
Power consumption	8 W
Safety standards	TUV-GS, CE (EN 60950)

UNITED KINGDOM PLUG STANDARDS

AC Power Adapter model	AA-121AD
Input power	AC230Volts/50Hz/140mA
Output power	AC12Volts/1.0A
Power consumption	8 W
Safety standards	ITS-GS, CE (EN 60950)

Appendix B

Virtual Circuit Topology

ATM is a connection-oriented technology, meaning that it sets up virtual circuits over which end systems communicate. The terminology for virtual circuits is as follows:

- **Virtual Channel** Logical connections between ATM switches
- **Virtual Path** A bundle of virtual channels
- **Virtual Circuit** A series of virtual paths between circuit end points

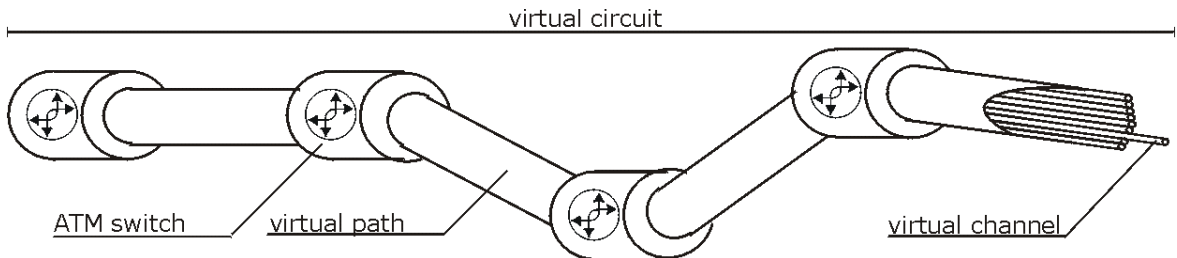

Diagram 1 Virtual Circuit Topology

Think of a virtual path as a cable that contains a bundle of wires. The cable connects two points and wires within the cable provide individual circuits between the two points. In an ATM cell header, a VPI (Virtual Path Identifier) identifies a link formed by a virtual path; a VCI (Virtual Channel Identifier) identifies a channel within a virtual path.

The VPI and VCI identify a virtual path, that is, termination points between ATM switches. A series of virtual paths make up a virtual circuit.

Your service provider should supply you with VPI/VCI numbers.

Appendix C

Setting up Your Computer's IP Address

All computers must have a 10M or 100M Ethernet adapter card and TCP/IP installed.

Windows 95/98/Me/NT/2000/XP, Macintosh OS 7 and later operating systems and all versions of UNIX/LINUX include the software components you need to install and use TCP/IP on your computer. Windows 3.1 requires the purchase of a third-party TCP/IP application package.

TCP/IP should already be installed on computers using Windows NT/2000/XP, Macintosh OS 7 and later operating systems.

After the appropriate TCP/IP components are installed, configure the TCP/IP settings in order to "communicate" with your network.

If you manually assign IP information instead of using dynamic assignment, make sure that your computers have IP addresses that place them in the same subnet as the Prestige's LAN port.

Windows 95/98/Me

Click **Start**, **Settings**, **Control Panel** and double-click the **Network** icon to open the **Network** window.

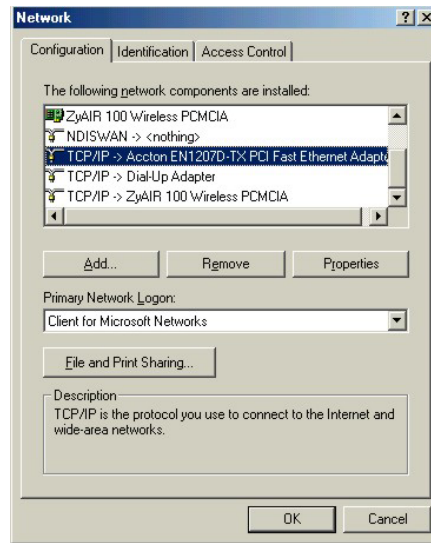

The **Network** window **Configuration** tab displays a list of installed components. You need a network adapter, the TCP/IP protocol and Client for Microsoft Networks.

If you need the adapter:

- a. In the **Network** window, click **Add**.
- b. Select **Adapter** and then click **Add**.
- c. Select the manufacturer and model of your network adapter and then click **OK**.

If you need TCP/IP:

- a. In the **Network** window, click **Add**.
- b. Select **Protocol** and then click **Add**.
- c. Select **Microsoft** from the list of **manufacturers**.
- d. Select **TCP/IP** from the list of network protocols and then click **OK**.

If you need Client for Microsoft Networks:

- a. Click **Add**.
- b. Select **Client** and then click **Add**.
- c. Select **Microsoft** from the list of manufacturers.
- d. Select **Client for Microsoft Networks** from the list of network clients and then click **OK**.
- e. Restart your computer so the changes you made take effect.

In the **Network** window **Configuration** tab, select your network adapter's TCP/IP entry and click **Properties**.

1. Click the **IP Address** tab.

-If your IP address is dynamic, select **Obtain an IP address automatically**.

-If you have a static IP address, select **Specify an IP address** and type your information into the **IP Address** and **Subnet Mask** fields.

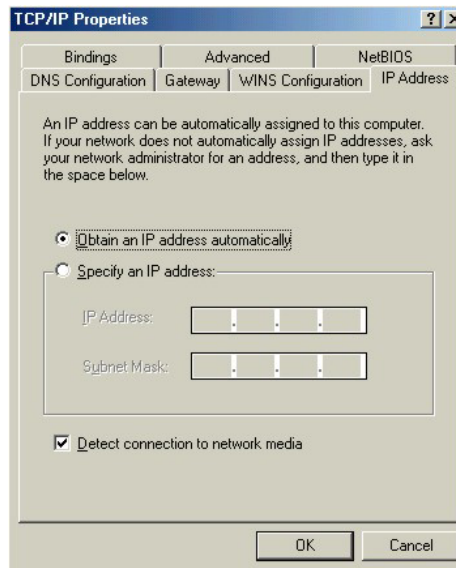

2. Click the **DNS Configuration** tab.

-If you do not know your DNS information, select **Disable DNS**.

-If you know your DNS information, select **Enable DNS** and type the information in the fields below (you may not need to fill them all in).

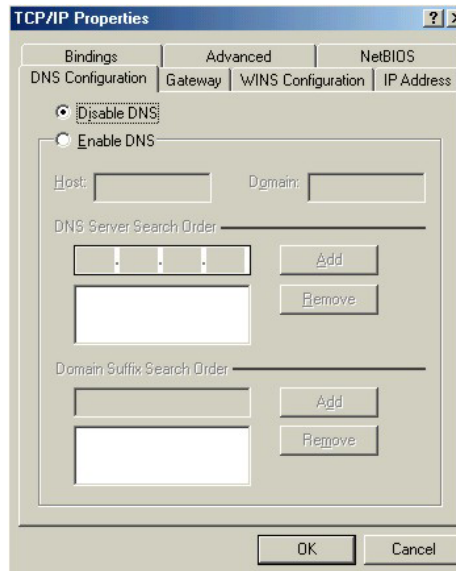

- Click the **Gateway** tab.
 - If you do not know your gateway's IP address, remove previously installed gateways.
 - If you have a gateway IP address, type it in the **New gateway field** and click **Add**.

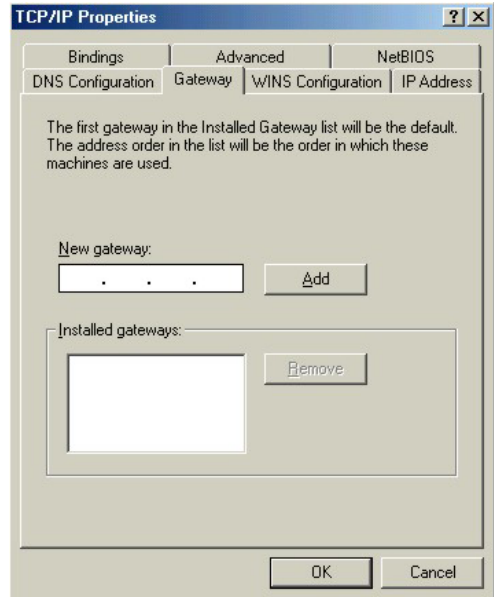

- Click **OK** to save and close the **TCP/IP Properties** window.
- Click **OK** to close the **Network** window. Insert the Windows CD if prompted.
- Turn on your Prestige and restart your computer when prompted.

Verifying Your Computer's IP Address

- Click **Start** and then **Run**.
- In the **Run** window, type "winipcfg" and then click **OK** to open the **IP Configuration** window.
- Select your network adapter. You should see your computer's IP address, subnet mask and default gateway.

Windows 2000/NT/XP

1. For Windows XP, click **start**, **Control Panel**. In Windows 2000/NT, click **Start, Settings, Control Panel**.



2. For Windows XP, click **Network Connections**. For Windows 2000/NT, click **Network and Dial-up Connections**.



3. Right-click **Local Area Connection** and then click **Properties**.

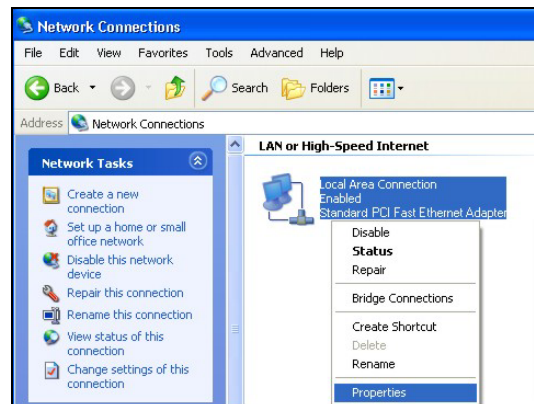

4. Select **Internet Protocol (TCP/IP)** (under the **General** tab in Win XP) and click **Properties**.

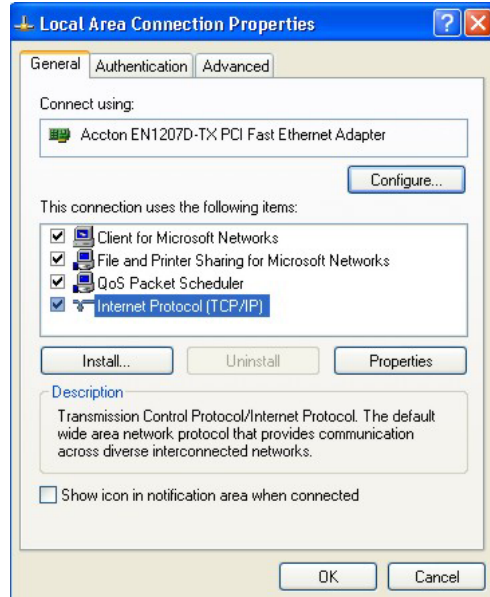

5. The **Internet Protocol TCP/IP Properties** window opens (the **General** tab in Windows XP).

-If you have a dynamic IP address click **Obtain an IP address automatically**.

-If you have a static IP address click **Use the following IP Address** and fill in the **IP address**, **Subnet mask**, and **Default gateway** fields.

Click **Advanced**.

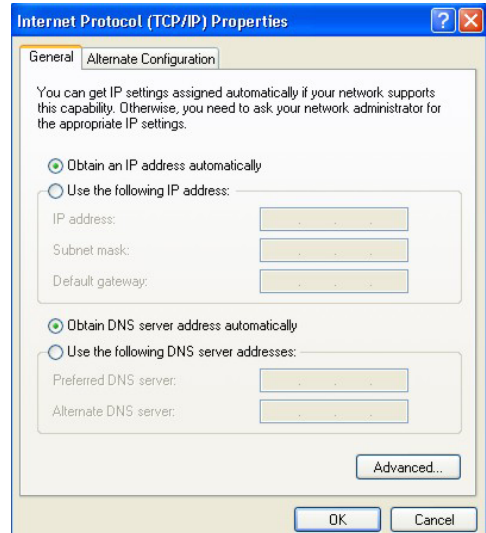

6. -If you do not know your gateway's IP address, remove any previously installed gateways in the **IP Settings** tab and click **OK**.

Do one or more of the following if you want to configure additional IP addresses:

-In the **IP Settings** tab, in IP addresses, click **Add**.

-In **TCP/IP Address**, type an IP address in **IP address** and a subnet mask in **Subnet mask**, and then click **Add**.

-Repeat the above two steps for each IP address you want to add.

-Configure additional default gateways in the **IP Settings** tab by clicking **Add** in **Default gateways**.

-In **TCP/IP Gateway Address**, type the IP address of the default gateway in **Gateway**. To manually configure a default metric (the number of transmission hops), clear the **Automatic metric** check box and type a metric in **Metric**.

-Click **Add**.

-Repeat the previous three steps for each default gateway you want to add.

-Click **OK** when finished.

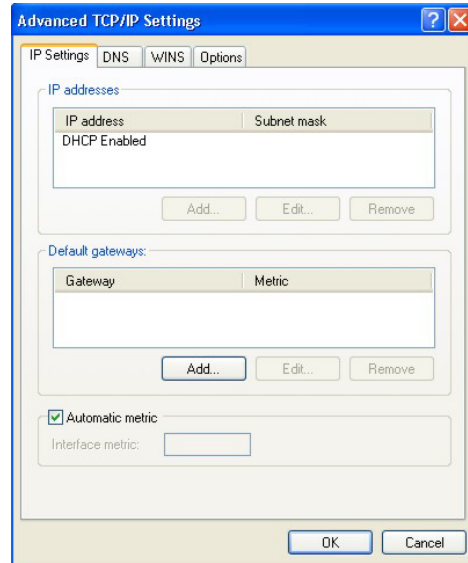

- In the **Internet Protocol TCP/IP Properties** window (the **General tab** in Windows XP):

-Click **Obtain DNS server address automatically** if you do not know your DNS server IP address(es).

-If you know your DNS server IP address(es), click **Use the following DNS server addresses**, and type them in the **Preferred DNS server** and **Alternate DNS server** fields.

If you have previously configured DNS servers, click **Advanced** and then the **DNS** tab to order them.

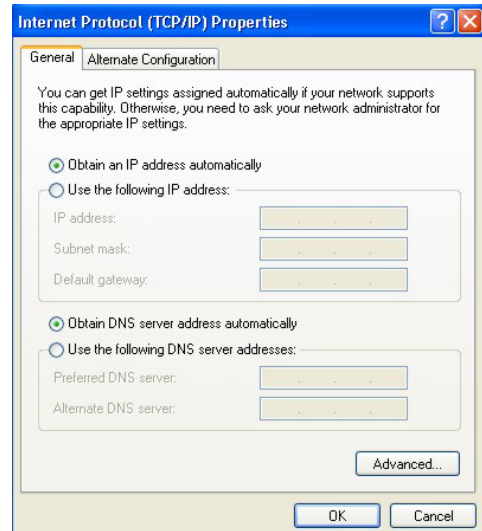

- Click **OK** to close the **Internet Protocol (TCP/IP) Properties** window.
- Click **OK** to close the **Local Area Connection Properties** window.
- Turn on your Prestige and restart your computer (if prompted).

Verifying Your Computer's IP Address

- Click **Start, All Programs, Accessories** and then **Command Prompt**.
- In the **Command Prompt** window, type "ipconfig" and then press [ENTER]. You can also open **Network Connections**, right-click a network connection, click **Status** and then click the **Support** tab.

Macintosh OS 8/9

1. Click the **Apple** menu, **Control Panel** and double-click **TCP/IP** to open the **TCP/IP Control Panel**.

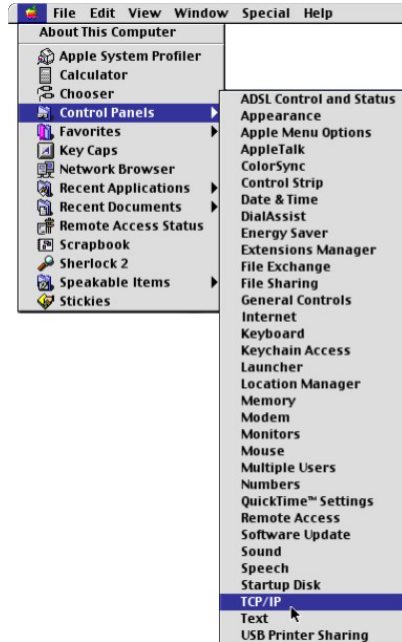

2. Select **Ethernet built-in** from the **Connect via** list.

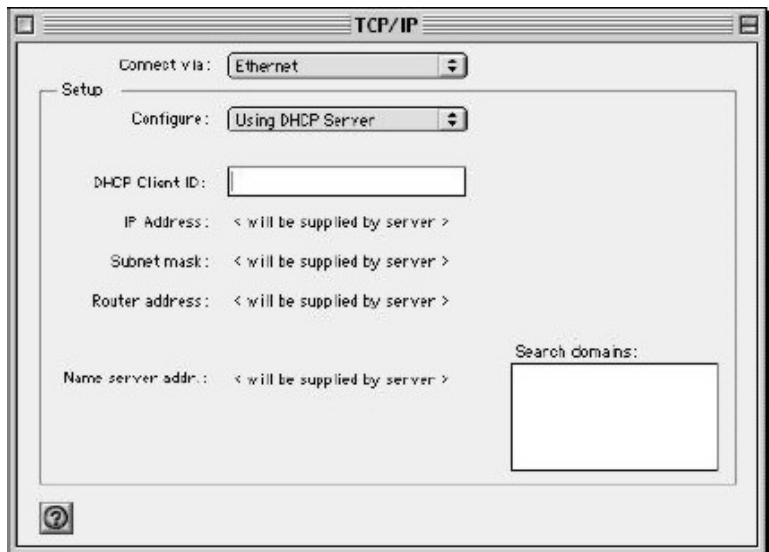

3. For dynamically assigned settings, select **Using DHCP Server** from the **Configure:** list.

4. For statically assigned settings, do the following:
 - From the **Configure** box, select **Manually**.
 - Type your IP address in the **IP Address** box.
 - Type your subnet mask in the **Subnet mask** box.
 - Type the IP address of your Prestige in the **Router address** box.
5. Close the **TCP/IP Control Panel**.
6. Click **Save** if prompted, to save changes to your configuration.
7. Turn on your Prestige and restart your computer (if prompted).

Verifying Your Computer's IP Address

Check your TCP/IP properties in the **TCP/IP Control Panel** window.

Macintosh OS X

1. Click the **Apple** menu, and click **System Preferences** to open the **System Preferences** window.

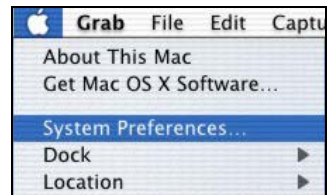

2. Click **Network** in the icon bar.
 - Select **Automatic** from the **Location** list.
 - Select **Built-in Ethernet** from the **Show** list.
 - Click the **TCP/IP** tab.

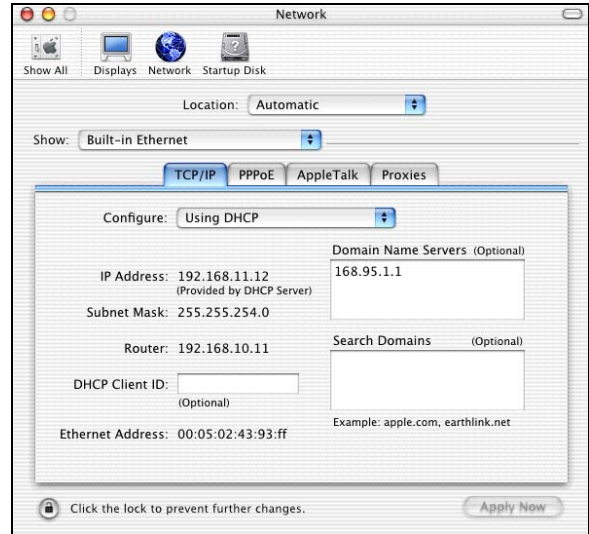

3. For dynamically assigned settings, select **Using DHCP** from the **Configure** list.
4. For statically assigned settings, do the following:
 - From the **Configure** box, select **Manually**.
 - Type your IP address in the **IP Address** box.
 - Type your subnet mask in the **Subnet mask** box.
 - Type the IP address of your Prestige in the **Router address** box.
5. Click **Apply Now** and close the window.
6. Turn on your Prestige and restart your computer (if prompted).

Verifying Your Computer's IP Address

Check your TCP/IP properties in the **Network** window.

M	
Main Menu	3-3
MBS (Maximum Burst Size)	4-3, 4-5.
Multiplexing	
LLC-based	4-2
VC-based	4-2
Multiplexing	1-2, 4-2, 4-5
Multiprotocol Encapsulation.....	4-2
N	
Network Management	1-2
NIC	2-3
P	
Packet	
Error.....	7-2
Received	7-3
Transmitted.....	7-3
Packets.....	7-2
PAP.....	5-3
Password.....	2-3, 3-1, 3-4, 5-2, 5-3
Point-to-Point.....	xv
PPPoA.....	4-3
PVC Connection	
Fail.....	9-2
R	
RAS	7-4
Rate	
Receiving.....	7-2
Transmission.....	7-2
Related Documentation.....	xiii
Remote Node	5-1, 7-2
Remote Node Index Number	7-2
Remote Node Setup	5-1, 5-2
Remote Node Traffic	6-8
Required fields.....	3-3
RESET Button	2-3
Restore Configuration.....	8-6
RFC-1483	4-3

RFC-2364	4-3, 5-2
S	
SCR See Sustain Cell Rate. See Sustain Cell Rate Service.....	iv
Splitters.....	2-4
STP	2-3
Subnet Mask	3-7, 3-8, 7-4
Support Disk.....	xiii
Syntax Conventions.....	xiv
System	
Console Port Speed.....	7-5
Diagnostic.....	7-5
System Information	7-4
System Status	7-1
System Information	7-3
System Information and Diagnosis.....	7-1
System Maintenance. 7-1, 7-3, 7-6, 8-2, 8-5, 8-10	
System Management Terminal	3-2
T	
TFTP File Transfer	8-10
To avoid damage to the Prestige.....	2-3
Transmission Rates.....	xiii, 1-1
U	
Upload Firmware.....	8-8
V	
VC-based Multiplexing	4-3
VPI and VCI.....	4-1
X	
XMODEM Protocol	8-2
Z	
ZyNOS	8-2
ZyNOS F/W Version.....	8-2
ZyXEL Limited Warranty	
Note	iv