

Prestige 2602R

VoIP IAD

Support Notes

Version 3.40

Feb. 2005



INDEX

Application Notes	5
General Application Notes	5
Internet Connection.....	5
Setup the Prestige as a DHCP Relay.....	8
Configure an Internal Server Behind SUA	10
Configure a PPTP server Behind SUA	12
Using NAT / Multi-NAT	16
About Filter & Filter Examples	37
Using the Dynamic DNS (DDNS).....	60
Network Management Using SNMP	62
Using syslog.....	68
Using IP Alias	72
Using Call Scheduling	74
Using IP Multicast	79
Using Prestige traffic redirect	81
Using Universal Plug n Play (UPnP).....	84
VoIP Application Notes.....	91
Setup SIP Account	91
Phone port settings.....	95
Phone book Speed dial.....	97
FAQ	99
ZyNOS FAQ	99
What is ZyNOS?.....	99
How do I access the embedded web configurator?.....	99
What is the default LAN IP address and Password? Moreover, how do I change it?	100
How do I upload the ZyNOS firmware code via embeded web configurator?.....	100
How do I upgrade/backup the ZyNOS firmware by using FTP client program via LAN?	100
How do I upload or backup ROMFILE via web configurator?.....	101
How do I backup/restore configurations by using FTP client program via LAN?.....	101
Why can't I make Telnet to Prestige from WAN?	101
What should I do if I forget the system password?.....	102

What is SUA? When should I use SUA?.....	102
What is the difference between NAT and SUA?.....	102
How many network users can the SUA/NAT support?	103
What are Device filters and Protocol filters?.....	103
Why can't I configure device filters or protocol filters?	103
Product FAQ	103
What is the Prestige Integrated Access Device?	103
Will the Prestige work with my Internet connection?.....	104
What do I need to use the Prestige?	104
What is PPPoE?	104
Does the Prestige support PPPoE?.....	104
How do I know I am using PPPoE?.....	104
Why does my provider use PPPoE?.....	105
Which Internet Applications can I use with the Prestige?	105
How can I configure the Prestige?	105
What network interface does the Prestige support?.....	105
What can we do with Prestige?.....	105
Does Prestige support dynamic IP addressing?	105
What is the difference between the internal IP and the real IP from my ISP?	105
How does e-mail work through the Prestige?	106
Is it possible to access a server running behind SUA from the outside Internet? If possible, how?.....	106
What DHCP capability does the Prestige support?.....	106
How do I used the reset button, more over what field of parameter will be reset by reset button?	106
What network interface does the new Prestige series support?	107
How does the Prestige support TFTP?.....	107
Can the Prestige support TFTP over WAN?	107
How fast can the data go?	107
What is Multi-NAT?	108
When do I need Multi-NAT?	108
What IP/Port mapping does Multi-NAT support?	109
What is the difference between SUA and Multi-NAT?	110
What is BOOTP/DHCP?.....	110
What is DDNS?.....	110
When do I need DDNS service?	111

What DDNS servers does the Prestige support?.....	111
What is DDNS wildcard?.....	111
Does the Prestige support DDNS wildcard?.....	111
Can the Prestige SUA handle IPsec packets sent by the VPN gateway behind Prestige?	111
How do I setup my Prestige for routing IPsec packets over SUA?	112
VoIP FAQ	112
What is Voice over IP?.....	112
How does Voice over IP work?	112
Why use VoIP?.....	112
What is the relationship between codec and VoIP?	113
What advantage does Voice over IP can provide?	113
What is the difference between H.323 and SIP?.....	113
Can H.323 and SIP interoperate with one another?	113
What is voice quality?.....	113
How are voice quality normally rated?.....	113
What is codec?	114
What is the relation of codec and VoIP?	114
What codec does Prestige support?.....	114
Which codec should I choose?.....	114
What do I need in order to use SIP?	114
Unable to register with the SIP server?.....	115
I can register but can not establish a call?.....	115
I can make a call but the voice only goes one way not bothway?	115
I can receive a call but the voice only goes one way not bothway?	115
If all the about have been tried, but register still fail what should I do?....	116
I suspect there is a hardware problem with my Prestige what should I do?116	
Trouble Shooting	116
Using Embedded Packet Trace	116
Debug PPPoE Connection	131
CLI Command List.....	143

Application Notes

General Application Notes

Internet Connection

A typical Internet access application of the Prestige is shown below. For a small office, there are some components needs to be checked before accessing the Internet.

- Before you begin
- Setting up the Windows
- Setting up the Prestige router
- Troubleshooting

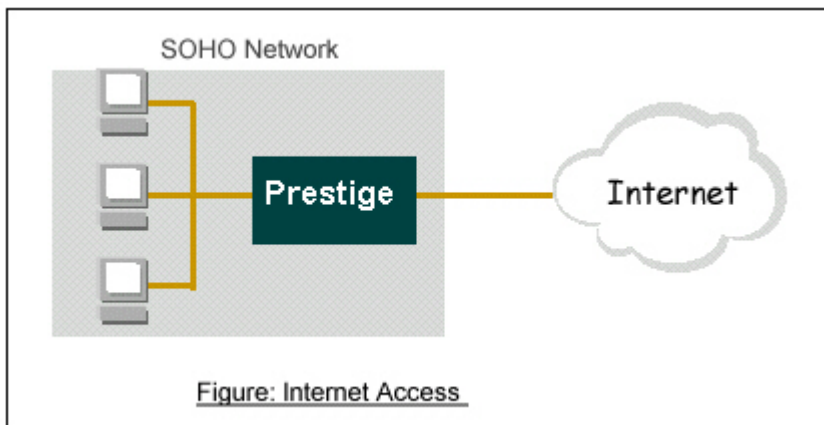

-
- Before you begin

The Prestige is shipped with the following factory default:

1. IP address = 192.168.1.1, subnet mask = 255.255.255.0 (24 bits)
2. DHCP server enabled with IP pool starting from 192.168.1.33
3. Default SMT menu password = 1234

- Setting up the PC (Windows OS)

1. Ethernet connection

All PCs must have an Ethernet adapter card installed.

- If you only have one PC, connect the PC's Ethernet adapter to the Prestige's LAN port with a crossover (red one) Ethernet cable.
- If you have more than one PC, both the PC's Ethernet adapters and the Prestige's LAN port must be connected to an external hub with straight Ethernet cable.

2. TCP/IP Installation

You must first install TCP/IP software on each PC before you can use it for Internet access. If you have already installed TCP/IP, go to the next section to configure it; otherwise, follow these steps to install:

- In the **Control Panel/Network** window, click **Add** button.
- In the **Select Network Component Type** windows, select **Protocol** and click **Add**.
- In the **Select Network Protocol** windows, select **Microsoft** from the manufacturers, then select **TCP/IP** from the **Network Protocols** and click **OK**.

3. TCP/IP Configuration

Follow these steps to configure Windows TCP/IP:

- In the **Control Panel/Network** window, click the **TCP/IP** entry to select it and click **Properties** button.
- In the **TCP/IP** Properties window, select **obtain an IP address automatically**.

Note: Do not assign arbitrary IP address and subnet mask to your PCs, otherwise, you will not be able to access the Internet.

- Click the **WINS** configuration tab and select **Disable WINS Resolution**.
- Click the **Gateway** tab. Highlight any installed gateways and click the **Remove** button until there are none listed.
- Click the **DNS Configuration** tab and select **Disable DNS**.
- Click **OK** to save and close the **TCP/IP** properties window
- Click **OK** to close the Network window. You will be prompted to insert your Windows CD or disk. When the drivers are updated, you will be asked if you want to restart the PC. Make sure your Prestige is powered on before answering Yes to the prompt. Repeat the above steps for each Windows PC on your network.
- **Setting up the Prestige router**

The following procedure is for the most typical usage of the Prestige where you have a single-user account (SUA). The Prestige supports embedded web server that allows you to use Web browser to configure it. Before configuring the router using Browser please be sure there is no Telnet or Console login.

1. Retrieve Prestige Web

Please enter the LAN IP address of the Prestige router in the URL location to retrieve the web screen from the Prestige. The default LAN IP of the Prestige is 192.168.1.1. See the example below. Note that you can either use <http://192.168.1.1>

2. Login first

The default password is the default SMT password, '1234'.



3. Configure Prestige for Internet access by using **WIZARD SETUP**

The Web screen shown below takes PPPoE as the example.

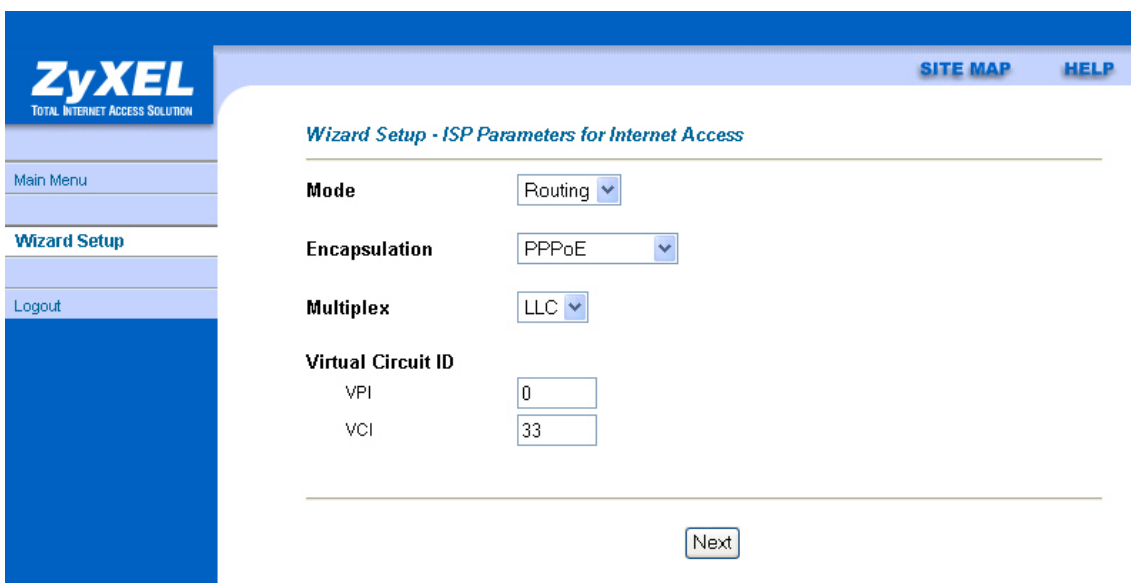

Select “Dynamic” if the ISP provides the IP dynamically, otherwise select “Use Fixed IP address” and enter the static IP given by ISP in the box following “MY WAN IP Address” field.

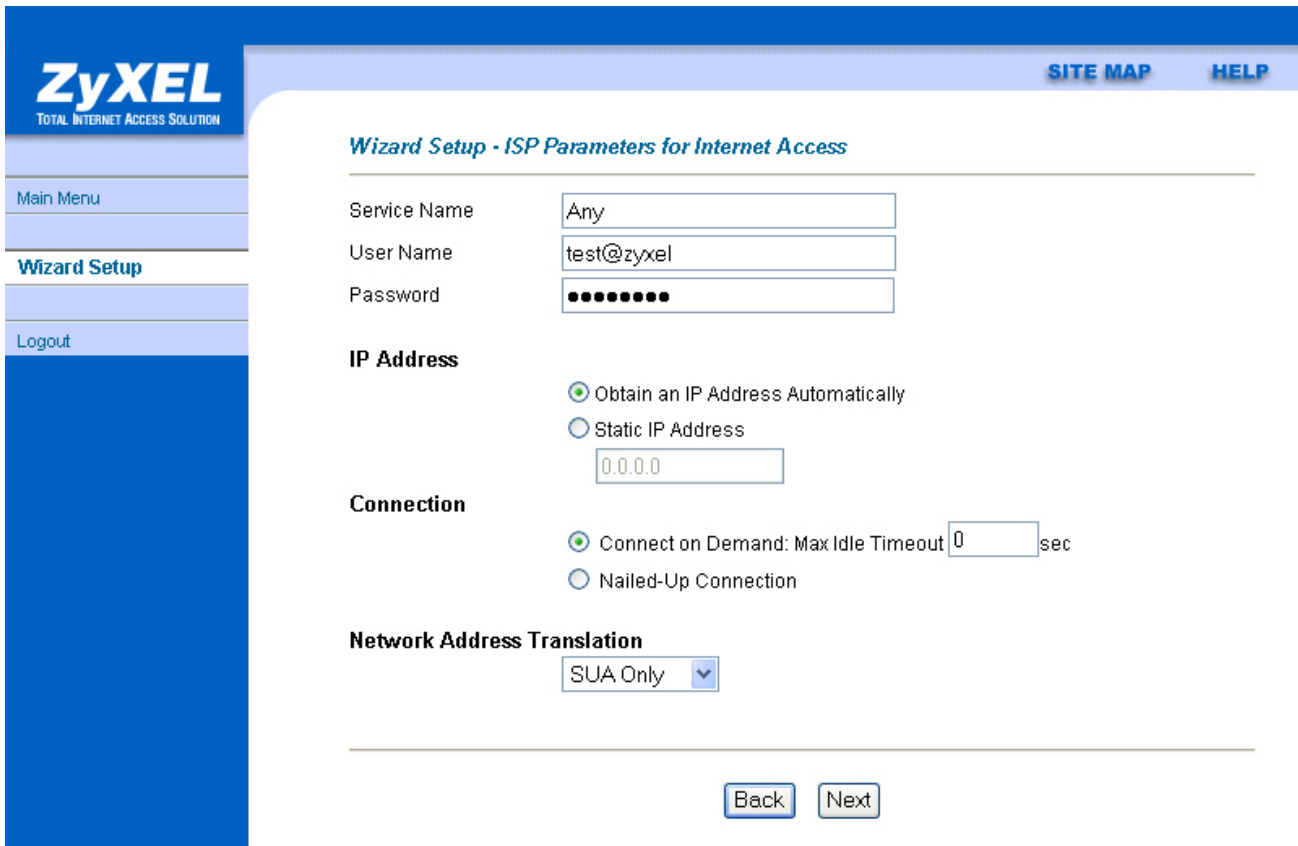

Setup the Prestige as a DHCP Relay

- What is DHCP Relay?

DHCP stands for Dynamic Host Configuration Protocol. In addition to the DHCP server feature, the P2602 supports the DHCP relay function. When it is configured as DHCP server, it assigns the IP addresses to the LAN clients. When it is configured as DHCP relay, it is responsible for forwarding the requests and responses negotiating between the DHCP clients and the server. See figure 1.

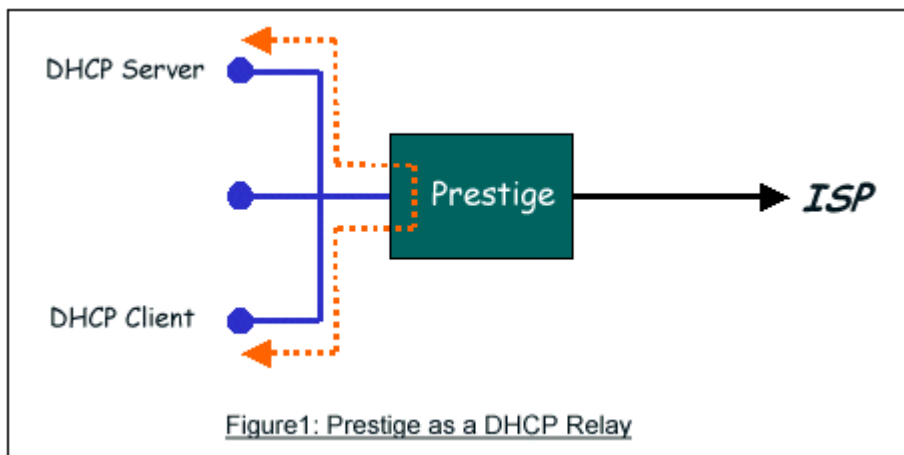

- Setup the Prestige as a DHCP Client

1. Toggle the DHCP to Relay in menu 3.2 and enter the IP address of the DHCP server in the 'Relay Server Address' field.

Menu 3.2 - TCP/IP and DHCP Setup

DHCP Setup

DHCP= **Relay**

Client IP Pool Starting Address= N/A

Size of Client IP Pool= N/A

Primary DNS Server= N/A

Secondary DNS Server= N/A

Remote DHCP Server= **192.168.1.2**

TCP/IP Setup:

IP Address= 192.168.1.1

IP Subnet Mask= 255.255.255.0

RIP Direction= None

Version= N/A

Multicast= None

IP Policies=

Edit IP Alias= No

Press ENTER to Confirm or ESC to Cancel:

Configure an Internal Server Behind SUA

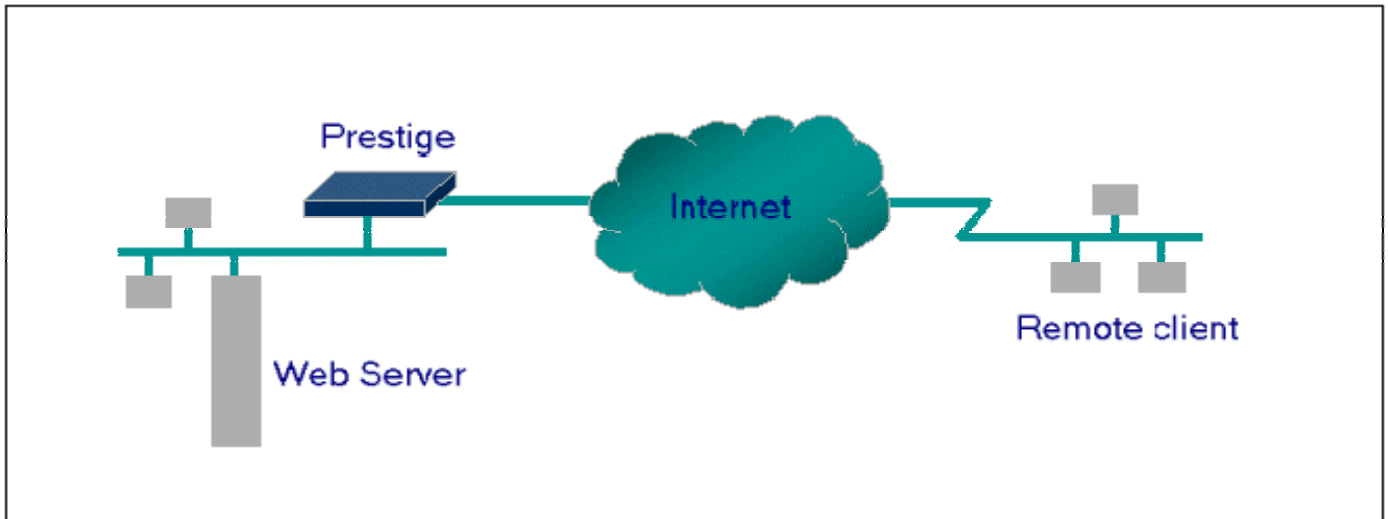

- Introduction

If you wish, you can make internal servers (e.g., Web, ftp or mail server) accessible for outside users, even though SUA makes your LAN appear as a single machine to the outside world. A service is identified by the port number. Also, since you need to specify the IP address of a server in the Prestige, a server must have a fixed IP address and not be a DHCP client whose IP address potentially changes each time it is powered on.

In addition to the servers for specific services, SUA supports a default server. A service request that does not have a server explicitly designated for it is forwarded to the default server. If the default server is not defined, the service request is simply discarded.

- Configuration

To make a server visible to the outside world, specify the port number of the service and the inside address of the server in 'Menu 15.2.1', Multiple Server Configuration. The outside users can access the local server using the Prestige's *WAN IP* address which can be obtained from menu 24.1.

- For example (Configuring an internal Web server for outside access) :

Menu 15.2 - NAT Server Setup

Rule Start Port No. End Port No. IP Address

1.	Default	Default	0.0.0.0
2.	80	80	192.168.1.10
3.	0	0	0.0.0.0
4.	0	0	0.0.0.0
5.	0	0	0.0.0.0
6.	0	0	0.0.0.0
7.	0	0	0.0.0.0
8.	0	0	0.0.0.0
9.	0	0	0.0.0.0
10.	0	0	0.0.0.0
11.	0	0	0.0.0.0
12.	0	0	0.0.0.0

Press ENTER to Confirm or ESC to Cancel:

- Port numbers for some services

Service	Port Number
FTP	21
Telnet	23
SMTP	25
DNS (Domain Name Server)	53
www-http (Web)	80

Configure a PPTP server Behind SUA

- Introduction

PPTP is a tunneling protocol defined by the PPTP forum that allows PPP packets to be encapsulated within Internet Protocol (IP) packets and forwarded over any IP network, including the Internet itself.

In order to run the Windows 9x PPTP client, you must be able to establish an IP connection with a tunnel server such as the Windows NT Server 4.0 Remote Access Server.

Windows Dial-Up Networking uses the Internet standard Point-to-Point (PPP) to provide a secure, optimized multiple-protocol network connection over dial-up telephone lines. All data sent over this connection can be encrypted and compressed, and multiple network level protocols (TCP/IP, NetBEUI and IPX) can be run correctly. Windows NT Domain Login level security is preserved even across the Internet.

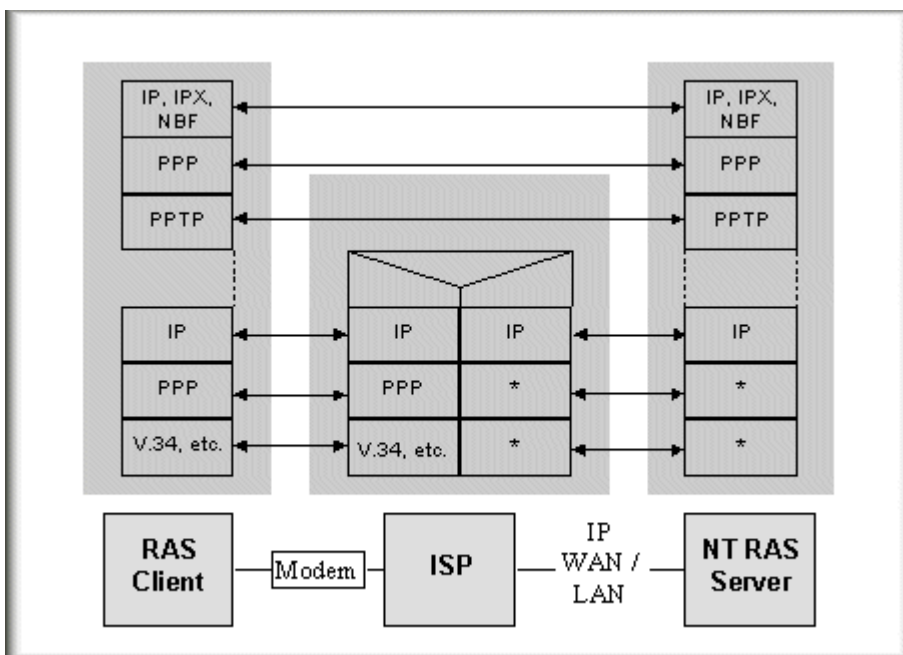

Window98 PPTP Client / Internet / NT RAS Server Protocol Stack

PPTP appears as new modem type (Virtual Private Networking Adapter) that can be selected when setting up a connection in the Dial-Up Networking folder. The VPN Adapter type does not appear elsewhere in the system. Since PPTP encapsulates its data stream in the PPP protocol, the VPN requires a second dial-up adapter. This second dial-up adapter for VPN is added during the installation phase of the Upgrade in addition to the first dial-up adapter that provides PPP support for the analog or ISDN modem.

The PPTP is supported in Windows NT and Windows 98 already. For Windows 95, it needs to be upgraded by the Dial-Up Networking 1.2 upgrade.

- Configuration

This application note explains how to establish a PPTP connection with a remote private network in the Prestige SUA case. In ZyNOS, all PPTP packets can be forwarded to the internal PPTP Server (WinNT server) behind SUA. The port number of the PPTP has to be entered in the SMT Menu 15 for Prestige to forward to the appropriate private IP address of Windows NT server.

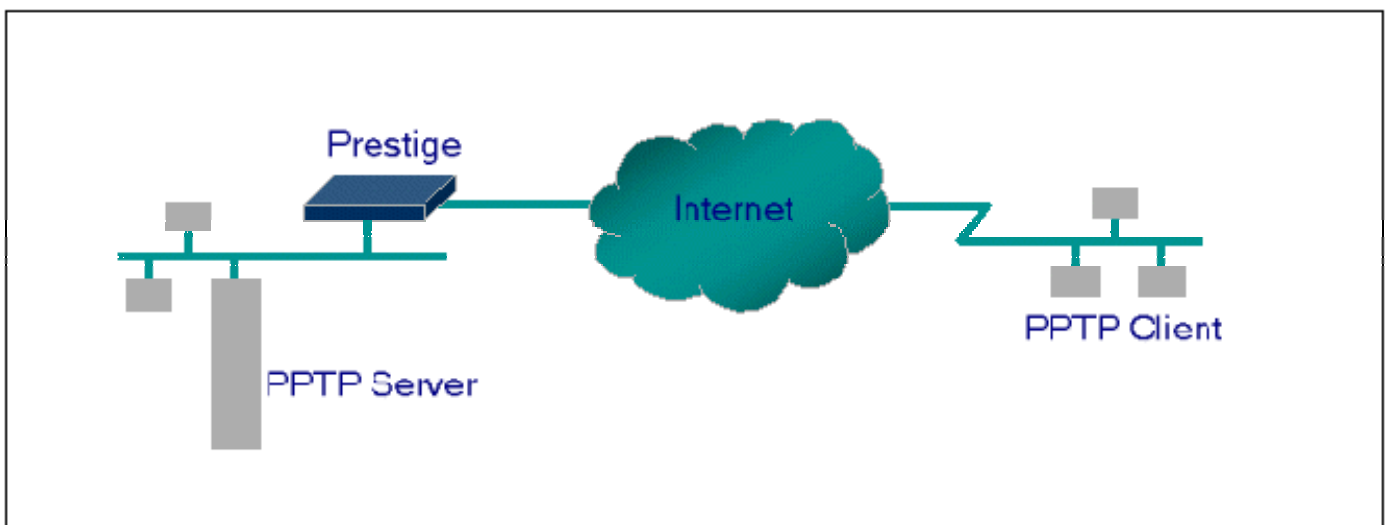

- Example

The following example shows how to dial to an ISP via the Prestige and then establish a tunnel to a private network. There will be three items that you need to set up for PPTP application, these are PPTP server (WinNT), PPTP client (Win9x) and the Prestige.

- PPTP server setup (WinNT)
 - Add the VPN service from Control Panel>Network
 - Add an user account for PPTP logged on user
 - Enable RAS port
 - Select the network protocols from RAS such as IPX, TCP/IP NetBEUI
 - Set the Internet gateway to Prestige
- PPTP client setup (Win9x)
 - Add one VPN connection from Dial-Up Networking by entering the correct username & password and the IP address of the Prestige's Internet IP address for logging to NT RAS server.

- Set the Internet gateway to the router that is connecting to ISP
 - Prestige router setup
- Before making a VPN connection from Win9x to WinNT server, you need to connect Prestige router to your ISP first.
- Enter the IP address of the PPTP server (WinNT server) and the port number for PPTP as shown below.

Menu 15.2 - NAT Server Setup (Used for SUA Only)

Rule	Start Port No.	End Port No.	IP Address
1.	Default	Default	0.0.0.0
2.	1723	1723	192.168.1.10
3.	0	0	0.0.0.0
4.	0	0	0.0.0.0
5.	0	0	0.0.0.0
6.	0	0	0.0.0.0
7.	0	0	0.0.0.0
8.	0	0	0.0.0.0
9.	0	0	0.0.0.0
10.	0	0	0.0.0.0
11.	0	0	0.0.0.0
12.	0	0	0.0.0.0

Press ENTER to Confirm or ESC to Cancel:

When you have finished the above settings, you can ping to the remote Win9x client from WinNT. This ping command is used to demonstrate that remote the Win9x can be reached across the Internet. If the Internet connection between two LANs is achieve, you can place a VPN call from the remote Win9x client.

For example:

C:\ping 203.66.113.2

When a dial-up connection to ISP is established, a default gateway is assigned to the router traffic through that connection. Therefore, the output below shows the default gateway of the Win9x client after the dial-up connection has been established.

Before making a VPN connection from the Win9x client to the NT server, you need to know the exact Internet IP address that the ISP assigns to Prestige router in SUA mode and enter this IP address in the VPN dial-up dialog box. You can check this Internet IP address from PNC Monitor or SMT Menu 24.1. If the Internet IP address is a fixed IP address provided by ISP in SUA mode, then you can always use this IP address for reaching the VPN server.

In the following example, the IP address '140.113.1.225' is dynamically assigned by ISP. You must enter this IP address in the 'VPN Server' dialog box for reaching the PPTP server. After the VPN link is established, you can start the network protocol application such as IP, IPX and NetBEUI.



Using NAT / Multi-NAT

- What is Multi-NAT?

NAT (Network Address Translation-NAT RFC 1631) is the translation of an Internet Protocol address used within one network to a different IP address known within another network. One network is designated the *inside* network and the other is the *outside*. Typically, a company maps its local inside network addresses to one or more global outside IP addresses and "unmaps" the global IP addresses on incoming packets back into local IP addresses. The IP addresses for the NAT can be either fixed or dynamically assigned by the ISP. In addition, you can designate servers, e.g., a web server and a telnet server, on your local network and make them accessible to the outside world. If you do not define any servers, NAT offers the additional benefit of firewall protection. In such case, all incoming connections to your network will be filtered out by the Prestige, thus preventing intruders from probing your network.

The SUA feature that the Prestige supports previously operates by mapping the private IP addresses to a global IP address. It is only one subset of the NAT. The Prestige with ZyNOS V3.40 supports the most of the features of the NAT based on RFC 1631, and we call this feature as '**Multi-NAT**'. For more information on IP address translation, please refer to RFC 1631, *The IP Network Address Translator (NAT)*.

- How NAT works

If we define the local IP addresses as the Internal Local Addresses (ILA) and the global IP addresses as the Inside Global Address (IGA), see the following figure. The term 'inside' refers to the set of networks that are subject to translation. NAT operates by mapping the ILA to the IGA required for communication with hosts on other networks. It replaces the original IP source address (and TCP or UDP source port numbers) and then forwards each packet to the Internet ISP, thus making them appear as if they had come from the NAT system itself (e.g., the Prestige router). The Prestige keeps track of the original addresses and port numbers so incoming reply packets can have their original values restored.

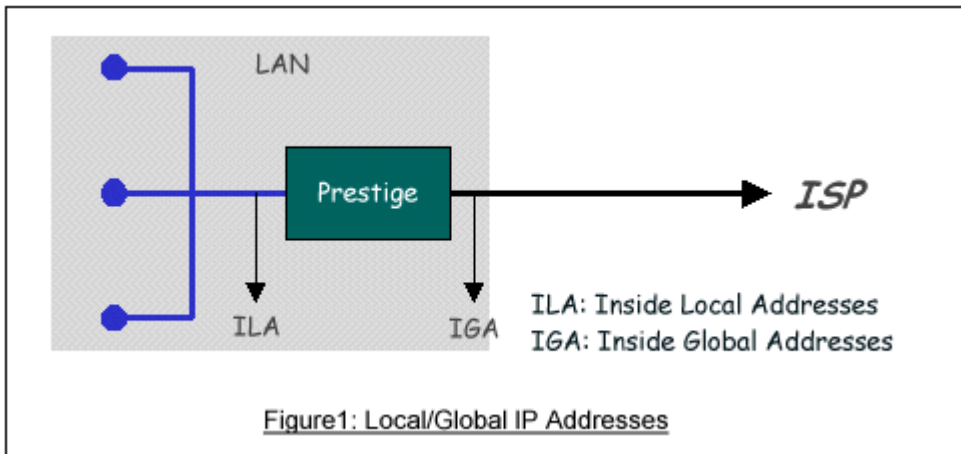

1. NAT Mapping Types

NAT supports five types of IP/port mapping. They are:

2. **One to One**

In One-to-One mode, the Prestige maps one ILA to one IGA.

3. **Many to One**

In Many-to-One mode, the Prestige maps multiple ILA to one IGA. This is equivalent to SUA (i.e., PAT, port address translation), ZyXEL's Single User Account feature that previous ZyNOS routers supported (the SUA only option in today's routers).

4. **Many to Many Overload**

In Many-to-Many Overload mode, the Prestige maps the multiple ILA to shared IGA.

5. **Many to Many No Overload**

In Many-to-Many No Overload mode, the Prestige maps each ILA to unique IGA.

- **Server**

In Server mode, the Prestige maps multiple inside servers to one global IP address. This allows us to specify multiple servers of different types behind the NAT for outside access. Note, if you want to map each server to one unique IGA please use the One-to-One mode.

The following table summarizes these types.

NAT Type	IP Mapping	Mapping Direction
One-to-One	ILA1<--->IGA1	Both
Many-to-One (SUA/PAT)	ILA1---->IGA1	Outgoing
	ILA2---->IGA1 ...	
Many-to-Many Overload	ILA1---->IGA1	Outgoing
	ILA2---->IGA2	
	ILA3---->IGA1	
	ILA4---->IGA2 ...	
Many-to-Many Overload (Allocate by Connections)	No ILA1---->IGA1	Outgoing
	ILA2---->IGA3	
	ILA3---->IGA2	
	ILA4---->IGA4	
	...	
Server	Server 1 IP<----IGA1	Incoming
	Server 2 IP<----IGA1	

- **SUA Versus NAT**

SUA (Single User Account) in previous ZyNOS versions is a NAT set with 2 rules, Many-to-One and Server. The Prestige now has **Full Feature** NAT support to map global IP addresses to local IP addresses of clients or servers. With multiple global IP addresses, multiple servers of the same type (e.g., FTP servers) are allowed on the LAN for outside access. In previous ZyNOS versions (that supported SUA 'visible' servers had to be of different types. The Prestige supports NAT sets on a remote node basis. They are reusable, but only one set is allowed for each remote node. The Prestige 2602HW supports 8 sets since there are 8 remote node. The default SUA (Read Only) Set in menu 15.1 is a convenient, pre-configured, read only, Many-to-One mapping set, sufficient for most purposes and helpful to people already familiar with SUA in previous ZyNOS versions.

- **SMT Menus**

1. Applying NAT in the SMT Menus

You apply NAT via menus 4 and 11.3 as displayed next. The next figure how you apply NAT for Internet access in menu 4. Enter 4 from the Main Menu to go to Menu 4-[Internet Access Setup](#).

```

Menu 4 - Internet Access Setup

ISP's Name= MyISP
Encapsulation= PPPoE
Multiplexing= LLC-based
VPI #- 0
VCI #- 33
ATM QoS Type= UBR
    Peak Cell Rate (PCR)= 0
    Sustain Cell Rate (SCR)= 0
    Maximum Burst Size (MBS)= 0
My Login= cso@zyxel
My Password= *****
Idle Timeout (sec)= 0
IP Address Assignment= Dynamic
    IP Address= N/A
Network Address Translation= Full Feature
    Address Mapping Set= 1

Press ENTER to Confirm or ESC to Cancel:
    
```

The following table describes the options for Network Address Translation.

Field	Options	Description
Network Address Translation	Full Feature	When you select this option the SMT will use Address Mapping Set 1 (Menu 15.1-see later for further discussion).
	None	NAT is disabled when you select this option.
	SUA Only	When you select this option the SMT will use Address Mapping Set 255 (Menu 15.1-see later for further discussion). This option use basically Many-to-One

	Overload mapping. Select Full Feature when you require other mapping types. It is a convenient, pre-configured, read only, Many-to-One mapping set, sufficient for most purposes and helpful to people already familiar with SUA in previous Zynos versions. Note that there is also a Server type whose IGA is 0.0.0.0 in this set.
--	-----------------------------------------------------------------------------------------------------------------------------------------------------------------------------------------------------------------------------------------------------------------------------------------------------------------------------------------------------------

Table: Applying NAT in Menu 4 and Menu 11.3

2. Configuring NAT

To configure NAT, enter 15 from the Main Menu to bring up the following screen.

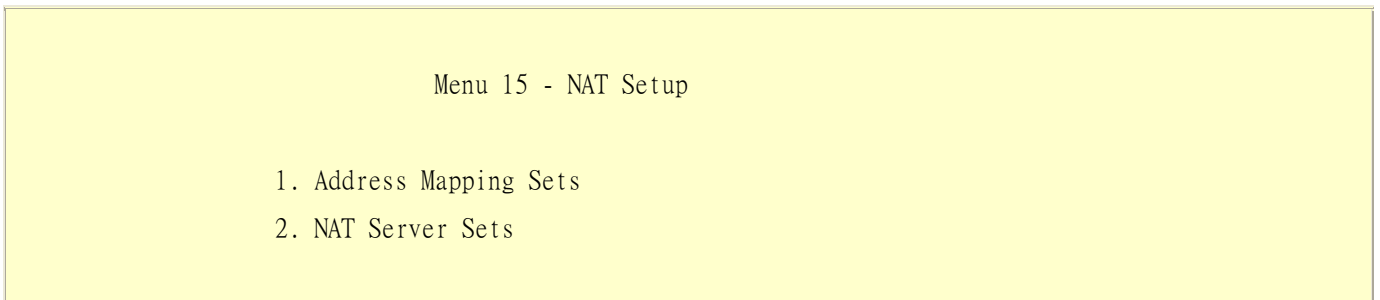

3. Address Mapping Sets and NAT Server Sets

Use the Address Mapping Sets menus and submenus to create the mapping table used to assign global addresses to LAN clients. Each remote node must specify which NAT Address Mapping Set to use. The P2602HW has 8 remote nodes and so allows you to configure 8 NAT Address Mapping Set. You can see nine NAT Address Mapping sets in Menu 15.1. You can only configure from Set 1 to Set 8. Set 255 is used for SUA. When you select **Full Feature** in menu 4 or 11.3. When you select **SUA Only**, the SMT will use Set 15.2.

The NAT Server Set is a list of LAN side servers mapped to external ports. To use this set (one set for the Prestige), a server rule must be set up inside the NAT Address Mapping set. Please see [NAT Server Sets](#) for further information on these menus.

Enter 1 to bring up Menu 15.1-Address Mapping Sets



Menu 15.1 - Address Mapping Sets

- 1.
- 2.
- 3.
- 4.
- 5.
- 6.
- 7.
- 8.
- 255. SUA (read only)

Enter Set Number to Edit:

Let's first look at Option 255. Option 255 is equivalent to SUA in previous ZyXEL routers. The fields in this menu cannot be changed. Entering 255 brings up this screen.

Menu 15.1.1 - Address Mapping Rules

Set Name= SUA

Idx	Local Start IP	Local End IP	Global Start IP	Global End IP	Type
1.	0.0.0.0	255.255.255.255	0.0.0.0		M-1
2.			0.0.0.0		Server
3.					
4.					
5.					
6.					
7.					
8.					
9.					
10.					

Press ENTER to Confirm or ESC to Cancel:

The following table explains the fields in this screen. Please note that the fields in this menu are read-only.

Field	Description	Option/Example
Set Name	This is the name of the set you selected in Menu 15.1 or enter the name of a new set you want to create.	SUA
Idx	This is the index or rule number.	1
Local Start IP	This is the starting local IP address (ILA).	0.0.0.0 for the Many-to-One type.
Local End IP	This is the starting local IP address (ILA). If the rule is for all local IPs, then the Start IP is 0.0.0.0 and the End IP is 255.255.255.255.	255.255.255.255
Global Start IP	This is the starting global IP address (IGA). If you have a dynamic IP, enter 0.0.0.0 as the Global Start IP.	0.0.0.0
Global End IP	This is the ending global IP address (IGA).	N/A
Type	This is the NAT mapping types.	Many-to-One and Server

Please note that the fields in this menu are read-only. However, the settings of the server set 1 can be modified in menu 15.1.1.

Now let's look at Option 1 in Menu 15.1.1 Enter 1 to bring up this menu.

```

Menu 15.1.1 - Address Mapping Rules
Set Name= ?
Idx  Local Start IP  Local End IP  Global Start IP  Global End IP  Type
---  -
1.
2.
3.
4.
5.
6.
7.
8.
    
```

```

9.
10.
      Action= Edit          , Select Rule= 0
      Press ENTER to Confirm or ESC to Cancel:
    
```

We will just look at the differences from the previous menu. Note that, this screen is not read only, so we have extra Action and Select Rule fields. Not also that the [?] in the Set Name field means that this is a required field and you must enter a name for the set. The description of the other fields is as described above. The Type, Local and Global Start/End IPs are configured in Menu 15.1.1 (described later) and the values are displayed here.

Field	Description	Option
Set Name	Enter a name for this set of rules. This is a required field. Please note that if this field is left blank, the entire set will be deleted.	Rule 1
Action	They are 4 actions. The default is Edit . Edit means you want to edit a selected rule (see following field). Insert Before means to insert a new rule before the rule selected. The rule after the selected rule will then be moved down by one rule. Delete means to delete the selected rule and then all the rules after the selected one will be advanced one rule. Save Set means to save the whole set (note when you choose this action the Select Rule item will be disabled).	Edit Insert Before Delete Save Set
Select Rule	When you choose Edit , Insert Before or Save Set in the previous field the cursor jumps to this field to allow you to select the rule to apply the action in question.	1

Note: **Save Set** in the **Action** field means to save the whole set. You must do this if you make any changes to the set-including deleting a rule. No changes to the set take place until this action is taken. Be careful when ordering your rules as each rule is executed in turn beginning from the first rule.

Selecting **Edit** in the **Action** field and then selecting a rule brings up the following menu, **Menu 15.1.1.1-Address Mapping Rule** in which you can edit an individual rule and configure the Type, Local and Global Start/End IPs displayed in Menu 15.1.1.

```

Menu 15.1.1.1 - - Rule 1
Type: One-to-One
    
```

```

Local IP:
  Start= 0.0.0.0
  End  = N/A
Global IP:
  Start= 0.0.0.0
  End  = N/A

Press ENTER to Confirm or ESC to Cancel:
    
```

The following table describes the fields in this screen.

Field		Description	Option/Example
Type		Press [SPACEBAR] to toggle through a total of 5 types. These are the mapping types discussed above plus a server type. Some examples follow to clarify these a little more.	One-to-One Many-to-One Many-to-Many Overload Many-to-Many No Overload Server
Local IP	Start	This is the starting local IP address (ILA)	0.0.0.0
	End	This is the ending local IP address (ILA). If the rule is for all local IPs, then put the Start IP as 0.0.0.0 and the End IP as 255.255.255.255. This field is N/A for One-to-One type.	255.255.255.255
Global IP	Start	This is the starting global IP address (IGA). If you have a dynamic IP, enter 0.0.0.0 as the Global Start IP .	0.0.0.0
	End	This is the ending global IP address (IGA). This field is N/A for One-to-One, Many-to-One and Server types.	200.1.1.64

Note: For all Local and Global IPs, the End IP address must begin after the IP Start address, i.e., you cannot have an End IP address beginning before the Start IP address.

- NAT Server Sets

The NAT Server Set is a list of LAN side servers mapped to external ports (similar to the old SUA menu of before). If you wish, you can make inside servers for different services, e.g., Web or FTP, visible to the outside users, even though NAT makes your network appears as a single machine to the outside world. A server is identified by the port number, e.g., Web service is on port 80 and FTP on port 21.

As an example (see the following figure), if you have a Web server at 192.168.1.36 and a FTP server at 192.168.1.33, then you need to specify for port 80 (Web) the server at IP address 192.168.1.36 and for port 21 (FTP) another at IP address 192.168.1.33.

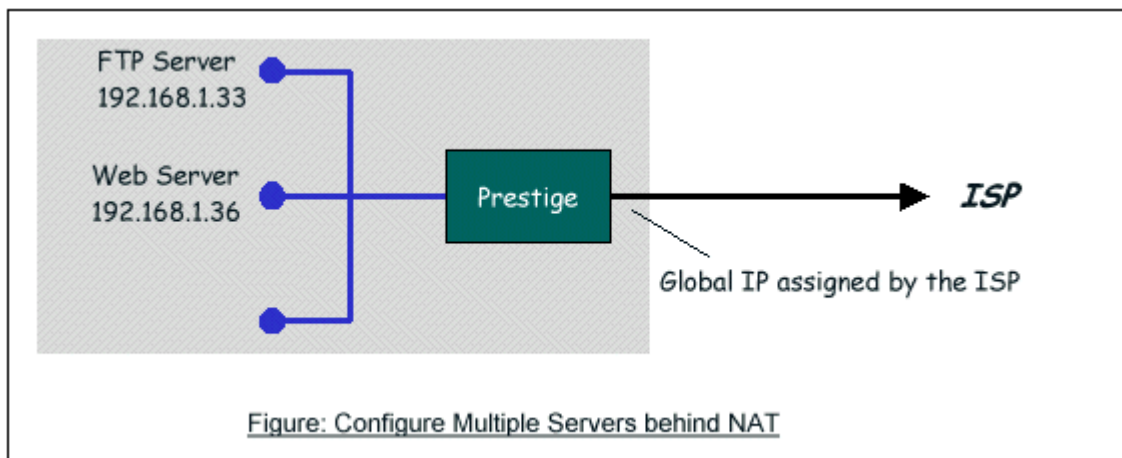

Please note that a server can support more than one service, e.g., a server can provide both FTP and Mail service, while another provides only Web service.

The following procedures show how to configure a server behind NAT.

- Step 1. Enter 15 in the Main Menu to go to **Menu 15-NAT Setup**.
- Step 2. Enter 2 to go to **Menu 15.2.1-NAT Server Setup**.
- Step 3. Enter the service port number in the **Port#** field and the inside IP address of the server in the **IP Address** field.
- Step 4. Press [SPACEBAR] at the 'Press ENTER to confirm...' prompt to save your configuration after you define all the servers or press ESC at any time to cancel.

Menu 15.2 - NAT Server Setup (Used for SUA Only)			
Rule	Start Port No.	End Port No.	IP Address
-----	-----	-----	-----
1.	Default	Default	0.0.0.0

2.	21	21	192.168.1.33
3.	80	80	192.168.1.36
4.	0	0	0.0.0.0
5.	0	0	0.0.0.0
6.	0	0	0.0.0.0
7.	0	0	0.0.0.0
8.	0	0	0.0.0.0
9.	0	0	0.0.0.0
10.	0	0	0.0.0.0
11.	0	0	0.0.0.0
12.	0	0	0.0.0.0

Press ENTER to Confirm or ESC to Cancel:

The most often used port numbers are shown in the following table. Please refer RFC 1700 for further information about port numbers.

Service	Port Number
FTP	21
Telnet	23
SMTP	25
DNS (Domain Name Server)	53
www-http (Web)	80
PPTP (Point-to-Point Tunneling Protocol)	1723

1.Internet Access Only

In our Internet Access example, we only need one rule where all our ILAs map to one IGA assigned by the ISP. See the following figure.

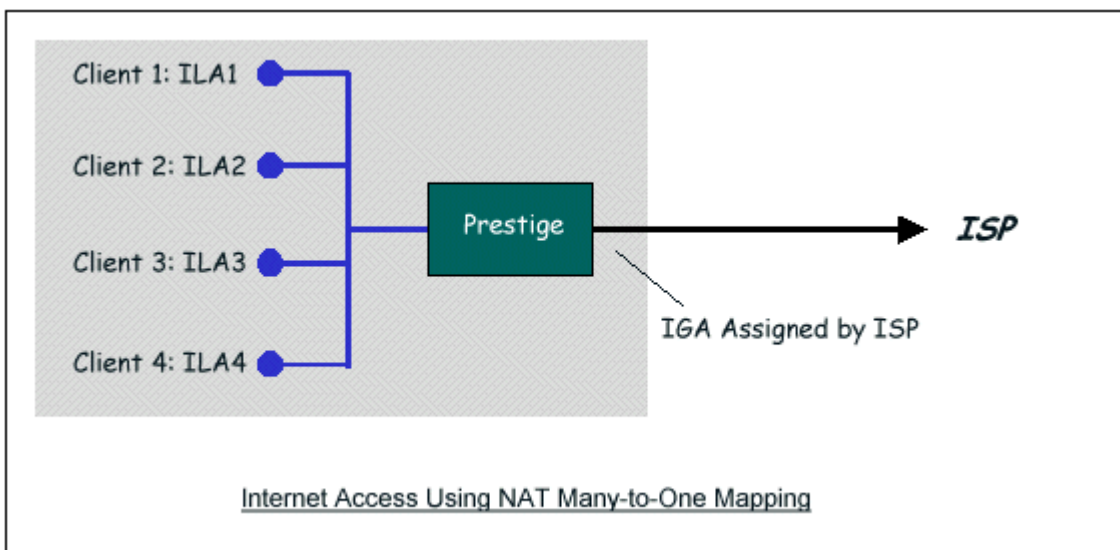

Menu 4 - Internet Access Setup

```

ISP's Name= MyISP
Encapsulation= PPPoE
Multiplexing= LLC-based
VPI #= 0
VCI #= 33
ATM QoS Type= UBR
    Peak Cell Rate (PCR)= 0
    Sustain Cell Rate (SCR)= 0
    Maximum Burst Size (MBS)= 0
My Login= cso@zyxel
My Password= *****
Idle Timeout (sec)= 0
IP Address Assignment= Dynamic
    IP Address= N/A
Network Address Translation= SUA Only
    Address Mapping Set= 1
    
```

Press ENTER to Confirm or ESC to Cancel:

From Menu 4 shown above simply choose the **SUA Only** option from the **NAT** field. This is the **Many-to-One** mapping discussed earlier. The SUA read only option from the NAT field in menu 4 and 11.3 is specifically pre-configured to handle this case.

2. Internet Access with an Internal Server

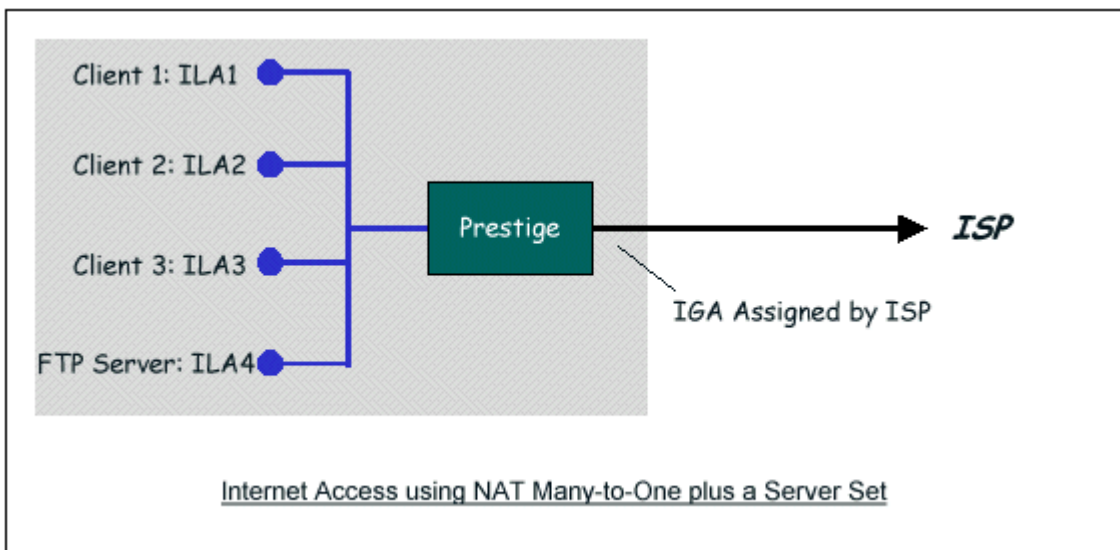

In this case, we do exactly as above (use the convenient pre-configured SUA Only set) and also go to Menu 15.2-NAT Server Setup (Used for SUA Only) to specify the Internet Server behind the NAT as shown in the NAT as shown below.

Menu 15.2 - NAT Server Setup (Used for SUA Only)

Rule	Start Port No.	End Port No.	IP Address
1.	Default	Default	0.0.0.0
2.	21	21	192.168.1.33
3.	0	0	0.0.0.0
4.	0	0	0.0.0.0
5.	0	0	0.0.0.0
6.	0	0	0.0.0.0
7.	0	0	0.0.0.0

8.	0	0	0.0.0.0
9.	0	0	0.0.0.0
10.	0	0	0.0.0.0
11.	0	0	0.0.0.0
12.	0	0	0.0.0.0

Press ENTER to Confirm or ESC to Cancel:

3.Using Multiple Global IP addresses for clients and servers (One-to-One, Many-to-One, Server Set mapping types are used)

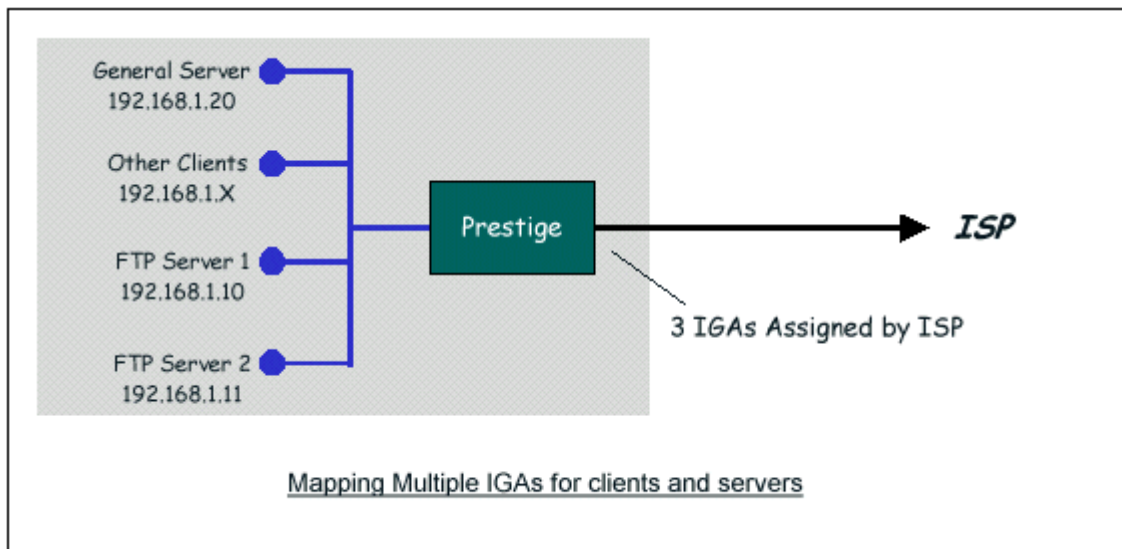

In this case we have 3 IGAs (IGA1, IGA2 and IGA3) from the ISP. We have two very busy internal FTP servers and also an internal general server for the web and mail. In this case, we want to assign the 3 IGAs by the following way using 4 NAT rules.

- 5. Rule 1 (One-to-One type) to map the FTP Server 1 with ILA1 (192.168.1.10) to IGA1.
- 6. Rule 2 (One-to-One type) to map the FTP Server 2 with ILA2 (192.168.1.11) to IGA2.
- 7. Rule 3 (Many-to-One type) to map the other clients to IGA3.
- 8. Rule 4 (Server type) to map a web server and mail server with ILA3 (192.168.1.20) to IGA3. Type **Server** allows us to specify multiple servers, of different types, to other machines behind NAT on the LAN.

Step 1:

In this case, we need to configure Address Mapping Set 1 from **Menu 15.1-Address Mapping Sets**. Therefore we must choose the **Full Feature** option from the **NAT** field in menu 4 or menu 11.3, and assign IGA3 to Prestige WAN IP Address.

Menu 4 - Internet Access Setup

```
ISP's Name= MyISP
Encapsulation= PPPoE
Service Type= N/A
My Login= cso@zyxel
My Password= *****
Retype to Confirm= *****
Idle Timeout= 100

IP Address Assignment= Static
IP Address= IGA3
IP Subnet Mask= N/A
Gateway IP Address= N/A
Network Address Translation= Full Feature

Press ENTER to Confirm or ESC to Cancel:
```

Step 2:

Go to menu 15.1 and choose 1 (not 255, SUA this time) to begin configuring this new set. Enter a **Set Name**, choose the **Edit Action** and then select 1 from **Select Rule** field. Press [ENTER] to confirm. See the following setup for the four rules in our case.

Rule 1 Setup: Select **One-to-One** type to map the FTP Server 1 with ILA1 (192.168.1.10) to IGA1.

```
Menu 15.1.1.1 - - Rule 1
Type: One-to-One
Local IP:
```

```
Start= 192.168.1.10
End  = N/A
Global IP:
Start= [Enter IGA1]
End  = N/A
Press ENTER to Confirm or ESC to Cancel:
```

Rule 2 Setup: Selecting **One-to-One** type to map the FTP Server 2 with ILA2 (192.168.1.11) to IGA2.

```
Menu 15.1.1.2 - - Rule 2
Type: One-to-One
Local IP:
Start= 192.168.1.11
End  = N/A
Global IP:
Start= [Enter IGA2]
End  = N/A
Press ENTER to Confirm or ESC to Cancel:
```

Rule 3 Setup: Select **Many-to-One** type to map the other clients to IGA3.

```
Menu 15.1.1.3 - - Rule 3
Type: Many-to-One
Local IP:
Start= 0.0.0.0
End  = 255.255.255.255
Global IP:
Start= [Enter IGA3]
End  = N/A
```

Press ENTER to Confirm or ESC to Cancel:

Rule 4 Setup: Select **Server type** to map our web server and mail server with ILA3 (192.168.1.20) to IGA3.

Menu 15.1.1.4 - - Rule 4

Type: **Server**

Local IP:

Start= N/A

End = N/A

Global IP:

Start= **[Enter IGA3]**

End = N/A

Press ENTER to Confirm or ESC to Cancel:

When we have configured all four rules Menu 15.1.1 should look as follows.

Menu 15.1.1 - Address Mapping Rules

Set Name= Example3

Idx	Local Start IP	Local End IP	Global Start IP	Global End IP	Type
1.	192.168.1.10		[IGA1]		1-1
2.	192.168.1.11		[IGA2]		1-1
3.	0.0.0.0	255.255.255.255	[IGA3]		M-1
4.			[IGA3]		Server
5.					
6.					
7.					
8.					

- 9.
- 10.

Press ESC or RETURN to Exit:

Step 3:

Now we configure all other incoming traffic to go to our web server and mail server from **Menu 15.2 - NAT Server Setup** (not Set 1, Set 1 is used for SUA Only case).

Menu 15.2 - NAT Server Setup

Rule	Start Port No.	End Port No.	IP Address
1.	Default	Default	0.0.0.0
2.	80	80	192.168.1.20
3.	25	25	192.168.1.20
4.	0	0	0.0.0.0
5.	0	0	0.0.0.0
6.	0	0	0.0.0.0
7.	0	0	0.0.0.0
8.	0	0	0.0.0.0
9.	0	0	0.0.0.0
10.	0	0	0.0.0.0
11.	0	0	0.0.0.0
12.	0	0	0.0.0.0

Press ENTER to Confirm or ESC to Cancel:

4. Support Non NAT Friendly Applications

Some servers providing Internet applications such as some mIRC servers do not allow users to login using the same IP address. In this case it is better to use Many-to-Many No Overload or One-to-One NAT mapping types, thus each user login to the server using a unique global IP address. The following figure illustrates this.

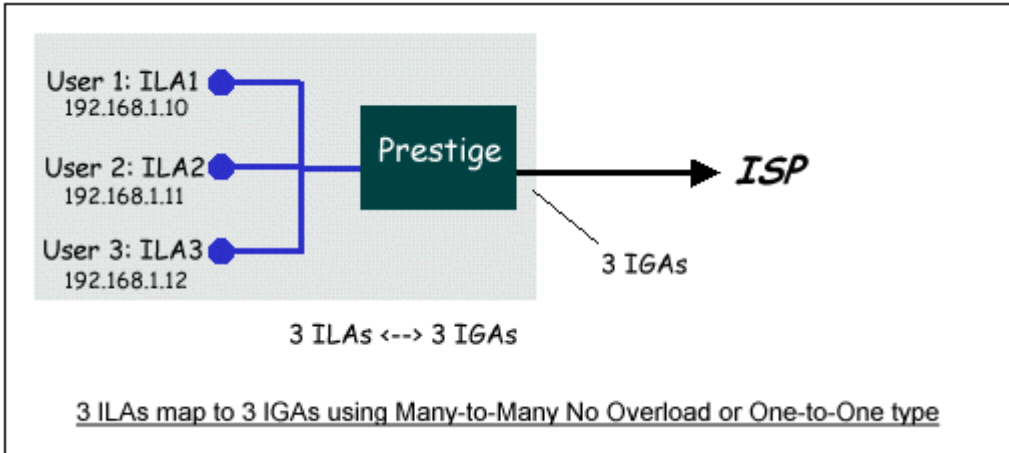

One rule configured for using **Many-to-Many No Overload** mapping type is shown below.

```
Menu 15.1.1.1 - - Rule 1
Type: Many-to-Many No Overload
Local IP:
  Start= 192.168.1.10
  End  = 192.168.1.12
Global IP:
  Start= [Enter IGA1]
  End  = [Enter IGA3]

Press ENTER to Confirm or ESC to Cancel:
```

The three rules configured for using **One-to-One** mapping type is shown below.

```
Menu 15.1.1.1 - - Rule 1

Type: One-to-One
```

Local IP:
Start= 192.168.1.10

End = N/A

Global IP:

Start= [Enter IGA1]

End = N/A

Press ENTER to Confirm or ESC to Cancel:

Menu 15.1.1.2 - - Rule 2

Type: One-to-One

Local IP:

Start= 192.168.1.11

End = N/A

Global IP:

Start= [Enter IGA2]

End = N/A

Press ENTER to Confirm or ESC to Cancel:

Menu 15.1.1.3 - - Rule 3

Type: One-to-One

Local IP:

Start= 192.168.1.12

End = N/A

Global IP:

Start= [Enter IGA3]

End = N/A

Press ENTER to Confirm or ESC to Cancel:

Prestige supports multiple type of NAT mapping rules

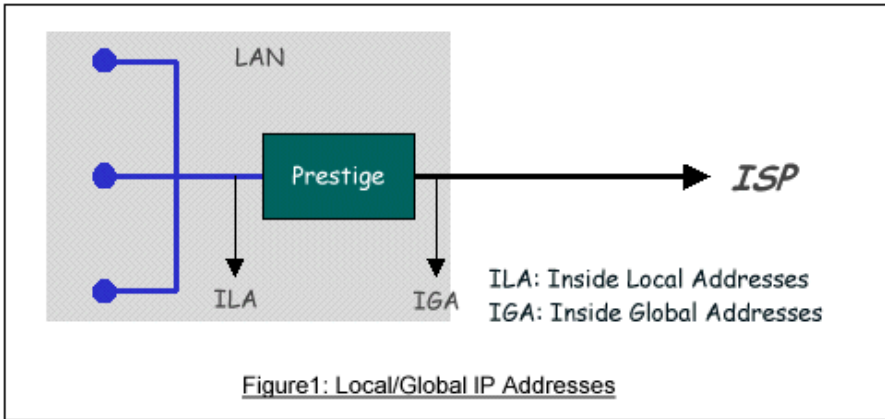

- SUA
- One to One
- Many to One
- Many to Many overload
- Many One to One
- Server

The following table summarizes these types.

NAT Type	IP Mapping
One-to-One	ILA1<--->IGA1
Many-to-One (SUA/PAT)	ILA1<--->IGA1 ILA2<--->IGA1 ...
Many-to-Many Overload	ILA1<--->IGA1 ILA2<--->IGA2 ILA3<--->IGA1 ILA4<--->IGA2
Many-to-Many No Overload	ILA1<--->IGA1 ILA2<--->IGA2 ILA3<--->IGA3 ILA4<--->IGA4

	...
Server (SUA)	Server 1 IP<--->IGA1 Server 2 IP<--->IGA1

About Filter & Filter Examples

How does ZyXEL filter work?

- **Filter Structure**

The Prestige allows you to configure up to twelve filter sets with six rules in each set, for a total of 72 filter rules in the system. You can apply up to four filter sets to a particular port to block multiple types of packets. With each filter set having up to six rules, you can have a maximum of 24 rules active for a single port. The following diagram illustrates the logic flow when executing a filter rule.

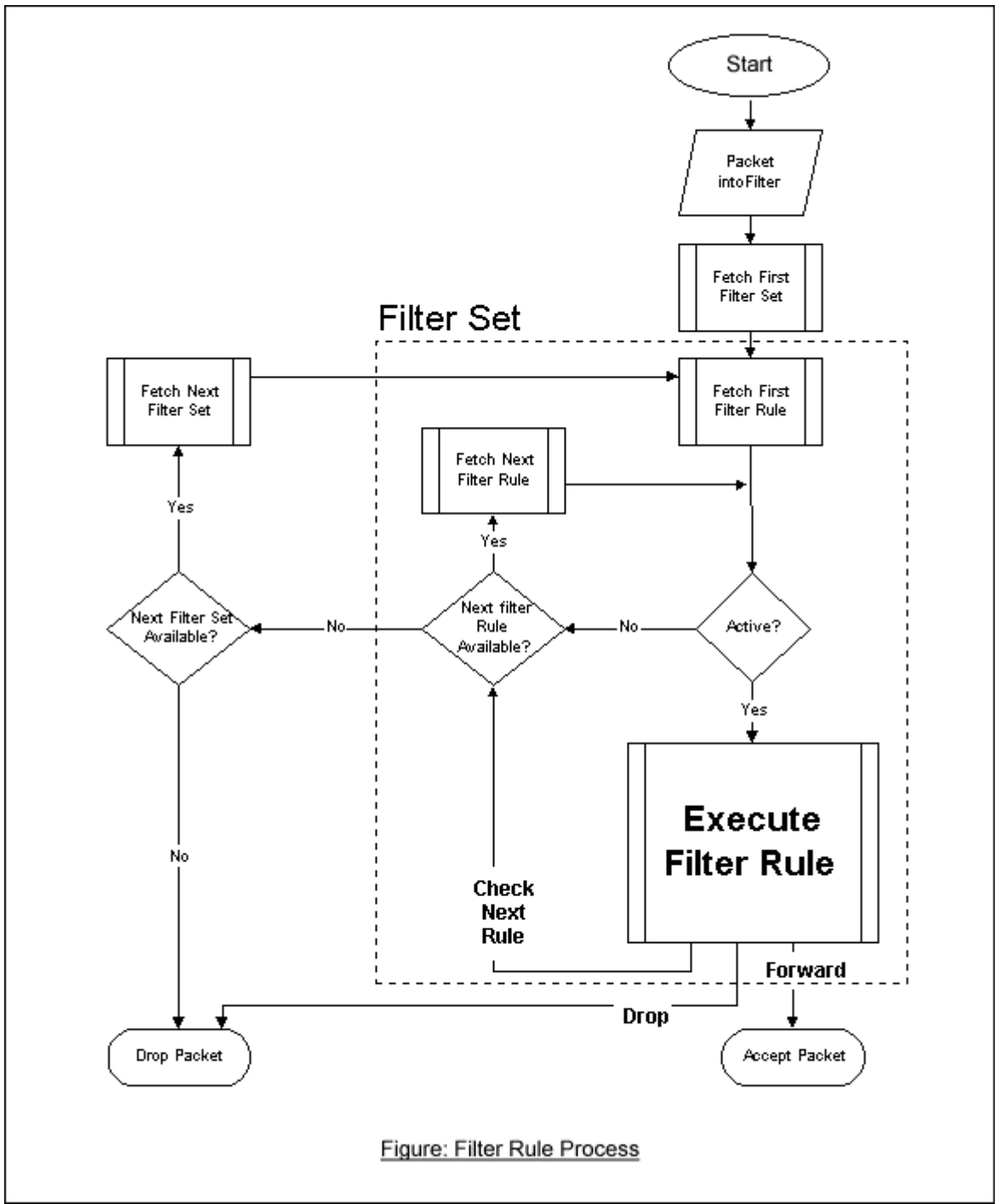

Figure: Filter Rule Process

- **Filter Types and SUA**

Conceptually, there are two categories of filter rules: **device** and **protocol**. The Generic filter rules belong to the device category; they act on the raw data from/to LAN and WAN. The IP and IPX filter rules belong to the protocol category; they act on the IP and IPX packets.

In order to allow users to specify the local network IP address and port number in the filter rules with SUA connections, the TCP/IP filter function has to be executed before SUA for WAN outgoing packets and after the SUA for WAN incoming IP packets. But at the same time, the Generic filter rules must be applied at the point when the Prestige is receiving and sending the packets; i.e. the ISDN interface. So, the execution sequence has to be changed. The logic flow of the filter is shown in Figure 1 and the sequence of the logic flow for the packet from LAN to WAN is:

- LAN device and protocol input filter sets.
- WAN protocol call and output filter sets.
- If SUA is enabled, SUA converts the source IP address from 192.168.1.33 to 203.205.115.6 and port number from 1023 to 4034.
- WAN device output and call filter sets.

The sequence of the logic flow for the packet from WAN to LAN is:

- WAN device input filter sets.
- If SUA is enabled, SUA converts the destination IP address from 203.205.115.6 to 92.168.1.33 and port number from 4034 to 1023.
- WAN protocol input filter sets.
- LAN device and protocol output filter sets.

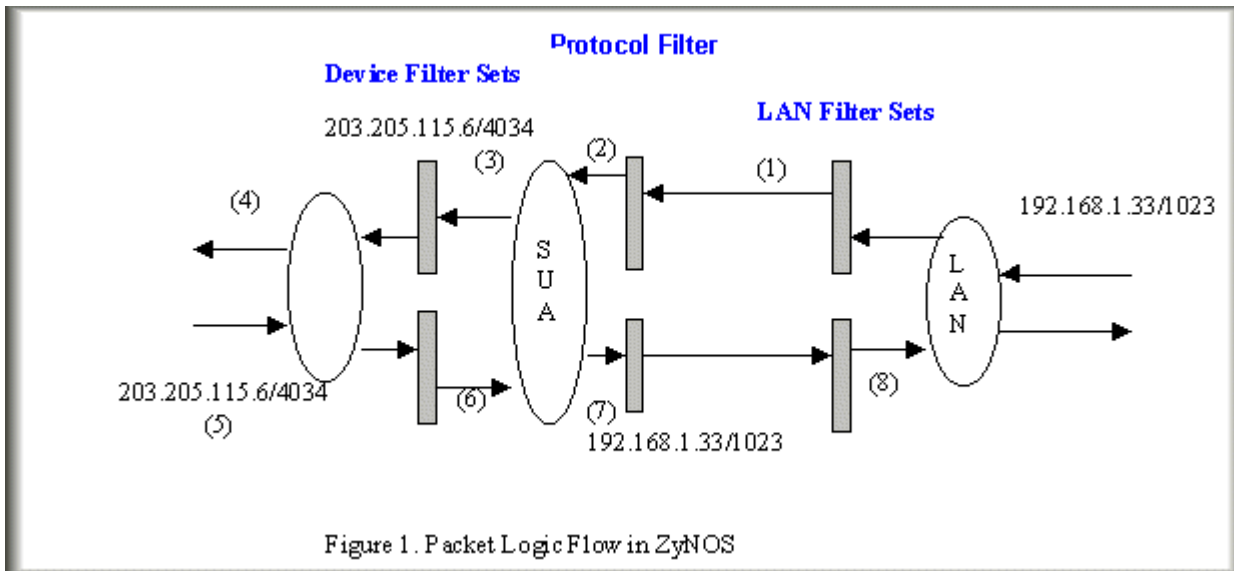

Generic and TCP/IP (and IPX) filter rules are in different filter sets. The SMT will detect and prevent the mixing of different category rules within any filter set in Menu 21. In the following example, you will receive an error message 'Protocol and device filter rules cannot be active together' if you try to activate a TCP/IP (or IPX) filter rule in a filter set that has already had one or more active Generic filter rules. You will receive the

same error if you try to activate a Generic filter rule in a filter set that has already had one or more active TCP/IP (or IPX) filter rules.

Menu 21.1.1:

```
Menu 21.1.1 - Generic Filter Rule
Filter #: 1,1
Filter Type= Generic Filter Rule
Active= Yes
Offset= 0
Length= 0
Mask= N/A
Value= N/A
More= No          Log= None
Action Matched= Check Next Rule
Action Not Matched= Check Next Rule
```

Menu 21.1.2:

```
Menu 21.1.2 - TCP/IP Filter Rule
Filter #: 1,2
Filter Type= TCP/IP Filter Rule
Active= Yes
IP Protocol= 0   IP Source Route= No
Destination: IP Addr= 0.0.0.0
                IP Mask= 0.0.0.0
                Port #= 0
                Port # Comp= None
Source: IP Addr= 0.0.0.0
                IP Mask= 0.0.0.0
                Port #= 0
                Port # Comp= None
TCP Estab= N/A
```



```
More= No          Log= None
Action Matched= Check Next Rule
Action Not Matched= Check Next Rule
```

Press ENTER to Confirm or ESC to Cancel:

Saving to ROM. Please wait...

Protocol and device rule cannot be active together

To separate the device and protocol filter categories; two new menus, Menu 11.5 and Menu 13.1, have been added, as well as some changes made to the Menu 3.1, Menu 11.1, and Menu 13. The new fields are shown below.

Menu 3.1:

```
Menu 3.1 - General Ethernet Setup
Input Filter Sets:
  protocol filters=
  device filters=
Output Filter Sets:
  protocol filters=
  device filters=
```

Menu 11.1:

```
Menu 11.1 - Remote Node Profile

Rem Node Name= LAN          Route= IP
Active= Yes                 Bridge= No

Encapsulation= PPP         Edit PPP Options= No
Incoming:                  Rem IP Addr= ?
Rem Login= test            Edit IP/IPX/Bridge= No
Rem Password= *****
```

```
Outgoing:                               Session Options:
My Login= testt                          Edit Filter Sets= Yes
My Password= *****
Authen= CHAP/PAP
Press ENTER to Confirm or ESC to Cancel:
```

Menu 11.5:

```
Menu 11.5 - Remote Node Filter
Input Filter Sets:
  protocol filters=
  device filters=
Output Filter Sets:
  protocol filters=
  device filters=
```

SMT will also prevent you from entering a protocol filter set configured in Menu 21 to the [device filters](#) field in Menu 3.1, 11.5, or entering a device filter set to the [protocol filters](#) field. Even though SMT will prevent the inconsistency from being entered in ZyNOS, it is unable to resolve the intermixing problems existing in the filter sets that were configured before. Instead, when ZyNOS translates the old configuration into the new format, it will verify the filter rules and log the inconsistencies. Please check the system log (Menu 24.3.1) before putting your device into use.

[In order to avoid operational problems later, the Prestige will disable its routing/bridging functions if there is an inconsistency among its filter rules.](#)

filter for blocking the web service

- Configuration

Before configuring a filter, you need to know the following information:

1. The outbound packet type (protocol & port number)
2. The source IP address

Generally, the outbound packets for Web service could be as following:

- a. HTTP packet, TCP (06) protocol with port number 80
- b. DNS packet, TCP (06) protocol with port number 53 or
- c. DNS packet, UDP (17) protocol with port number 53

For all workstation on the LAN, the source IP address will be 0.0.0.0. Otherwise, you have to enter an IP Address for the workstation you want to block. See the procedure for configuring this filter below.

- o Create a filter set in Menu 21, e.g., set 1
- o Create three filter rules in Menu 21.1.1, Menu 21.1.2, Menu 21.1.3
 - Rule 1- block the HTTP packet, TCP (06) protocol with port number 80
 - Rule 2- block the DNS packet, TCP (06) protocol with port number 53
 - Rule 3- block the DNS packet, UDP (17) protocol with port number 53
- o Apply the filter set in menu 4

1. Create a filter set in Menu 21

Menu 21 - Filter Set Configuration

Filter Set #	Comments	Filter Set #	Comments
1	Web Request	7	_____
2	_____	8	_____
3	_____	9	_____
4	_____	10	_____
5	_____	11	_____
6	_____	12	_____

Enter Filter Set Number to Configure= 1
 Edit Comments=
 Press ENTER to Confirm or ESC to Cancel:

2. Rule one for (a). http packet, TCP(06)/Port number 80

```
Menu 21.1.1 - TCP/IP Filter Rule
Filter #: 1,1
Filter Type= TCP/IP Filter Rule
Active= Yes
IP Protocol= 6      IP Source Route= No
Destination: IP Addr= 0.0.0.0
                IP Mask= 0.0.0.0
                Port #= 80
                Port # Comp= Equal
Source: IP Addr= 0.0.0.0
         IP Mask= 0.0.0.0
         Port #=
         Port # Comp= None
TCP Estab= No
More= No      Log= None
Action Matched= Drop
Action Not Matched= Check Next Rule
Press ENTER to Confirm or ESC to Cancel:
```

3. Rule 2 for (b). DNS request, TCP(06)/Port number 53

```
Menu 21.1.2 - TCP/IP Filter Rule
Filter #: 1,2
Filter Type= TCP/IP Filter Rule
Active= Yes
IP Protocol= 6      IP Source Route= No
Destination: IP Addr= 0.0.0.0
                IP Mask= 0.0.0.0
                Port #= 53
                Port # Comp= Equal
```

```
Source: IP Addr= 0.0.0.0
      IP Mask= 0.0.0.0
      Port #=
      Port # Comp= None
TCP Estab= No
More= No      Log= None
Action Matched= Drop
Action Not Matched= Check Next Rule
Press ENTER to Confirm or ESC to Cancel:
```

4. Rule 3 for (c). DNS packet UDP(17)/Port number 53

```
Menu 21.1.2 - TCP/IP Filter Rule
Filter #: 1,2
Filter Type= TCP/IP Filter Rule
Active= Yes
IP Protocol= 17      IP Source Route= No
Destination: IP Addr= 0.0.0.0
      IP Mask= 0.0.0.0
      Port #= 53
      Port # Comp= Equal
Source: IP Addr= 0.0.0.0
      IP Mask= 0.0.0.0
      Port #=
      Port # Comp= None
TCP Estab= No
More= No      Log= None
Action Matched= Drop
Action Not Matched= Forward
Press ENTER to Confirm or ESC to Cancel:
```

5. After the three rules are completed, you will see the rule summary in Menu 21.

Menu 21.1 - Filter Rules Summary

#	A	Type	Filter Rules	M	m	n
1	Y	IP	Pr=6, SA=0.0.0.0, DA=0.0.0.0, DP=80	N	D	N
2	Y	IP	Pr=6, SA=0.0.0.0, DA=0.0.0.0, DP=53	N	D	N
3	Y	IP	Pr=17, SA=0.0.0.0, DA=0.0.0.0, DP=53	N	D	F

6. Apply the filter set to the 'Output Protocol Filter Set' in the remote node setup.

A filter for blocking a specific client

Configuration

1. Create a filter set in Menu 21, e.g., set 1

Menu 21 - Filter Set Configuration

Filter Set #	Comments	Filter Set #	Comments
1	Block a client	7	_____
2	_____	8	_____
3	_____	9	_____
4	_____	10	_____
5	_____	11	_____
6	_____	12	_____

Enter Filter Set Number to Configure= 0
 Edit Comments=
 Press ENTER to Confirm or ESC to Cancel:

2. One rule for blocking all packets from this client

```
Menu 21.1.1 - TCP/IP Filter Rule
Filter #: 1,1
Filter Type= TCP/IP Filter Rule
Active= Yes
IP Protocol= 0      IP Source Route= No
Destination: IP Addr= 0.0.0.0
                IP Mask= 0.0.0.0
                Port #=
                Port # Comp= None
Source: IP Addr= 192.168.1.5
         IP Mask= 255.255.255.255
         Port #=
         Port # Comp= None
TCP Estab= N/A
More= No          Log= None
Action Matched= Drop
Action Not Matched= Forward
Press ENTER to Confirm or ESC to Cancel:
```

Key Settings:

Source IP addr.....Enter the client IP in this field

IP Mask.....here the IP mask is used to mask the bits of the IP address given in the **'Source IP Addr='** field, for one workstation it is 255.255.255.255.

Action Matched.....Set to 'Drop' to drop all the packets from this client

Action Not Matched.....Set to 'Forward' to allow the packets from other clients

3. Apply the filter set number '1' to the **'Output Protocol Filter Set'** field in the remote node setup.

A filter for blocking a specific MAC address

This configuration example shows you how to use a Generic Filter to block a specific MAC address of the LAN.

Before you Begin

Before you configure the filter, you need to know the MAC address of the client first. The MAC address can be provided by the NICs. If there is the LAN packet passing through the Prestige you can identify the uninteresting MAC address from the Prestige's LAN packet trace. Please have a look at the following example to know the trace of the LAN packets.

```
ras> sys trcp channel enet0 bothway
ras> sys trcp sw on
Now a client on the LAN is trying to ping Prestige.....
ras> sys trcp sw off
ras> sys trcp disp
TIME: 37c060 enet0-RECV len:74 call=0
0000: [00 a0 c5 01 23 45] [00 80 c8 4c ea 63] 08 00 45 00
0010: 00 3c eb 0c 00 00 20 01 e3 ea ca 84 9b 5d ca 84
0020: 9b 63 08 00 45 5c 03 00 05 00 61 62 63 64 65 66
0030: 67 68 69 6a 6b 6c 6d 6e 6f 70 71 72 73 74 75 76
0040: 77 61 62 63 64 65 66 67 68 69
TIME: 37c060 enet0-XMIT len:74 call=0
0000: [00 80 c8 4c ea 63] [00 a0 c5 01 23 45] 08 00 45 00
0010: 00 3c 00 07 00 00 fe 01 f0 ef ca 84 9b 63 ca 84
0020: 9b 5d 00 00 4d 5c 03 00 05 00 61 62 63 64 65 66
0030: 67 68 69 6a 6b 6c 6d 6e 6f 70 71 72 73 74 75 76
0040: 77 61 62 63 64 65 66 67 68 69
```

The detailed format of the Ethernet Version II:

```
+ Ethernet Version II
- Address: 00-80-C8-4C-EA-63 (Source MAC) ----> 00-A0-C5-23-45
  (Destination MAC)
- Ethernet II Protocol Type: IP
```



```

+ Internet Protocol
  - Version (MSB 4 bits): 4
  - Header length (LSB 4 bits): 5
  - Service type: Preced=Routine, Delay=Normal, Thrput=Normal, Reli=Normal
  - Total length: 60 (Octets)
  - Fragment ID: 60172
  - Flags: May be fragmented, Last fragment, Offset=0 (0x00)
  - Time to live: 32 seconds/hops
  - IP protocol type: ICMP (0x01)
  - Checksum: 0xE3EA
  - IP address 202.132.155.93 (Source IP address) ---->
    202.132.155.99(Destination IP address)
  - No option
+ Internet Control Message Protocol
  - Type: 8 - Echo Request
  - Code: 0
  - Checksum: 0x455C
  - Identifier: 768
  - Sequence Number: 1280
  - Optional Data: (32 bytes)
  
```

Configurations

From the above first trace, we know a client is trying to ping request the Prestige router. And from the second trace, we know the Prestige router will send a reply to the client accordingly. The following sample filter will utilize the 'Generic Filter Rule' to block the MAC address [\[00 80 c8 4c ea 63\]](#).

1. First, from the incoming LAN packet we know the uninteresting source MAC address starts at the 7th Octet

```

TIME: 37c060 enet0-RECV len:74 call=0
0000: [00 a0 c5 01 23 45] [00 80 c8 4c ea 63] 08 00 45 00
0010: 00 3c eb 0c 00 00 20 01 e3 ea ca 84 9b 5d ca 84
0020: 9b 63 08 00 45 5c 03 00 05 00 61 62 63 64 65 66
0030: 67 68 69 6a 6b 6c 6d 6e 6f 70 71 72 73 74 75 76
0040: 77 61 62 63 64 65 66 67 68 69
  
```

2. We are now ready to configure the 'Generic Filter Rule' as below.

```
Menu 21.1.1 - Generic Filter Rule
Filter #: 1,1
Filter Type= Generic Filter Rule
Active= Yes
Offset= 6
Length= 6
Mask= ffffffff
Value= 0080c84cea63
More= No          Log= None
Action Matched= Drop
Action Not Matched= Forward
```

Key Settings:

- Generic Filter Ruls
Set the 'Filter Type' to 'Generic Filter Rule'
- Active
Turn 'Active' to 'Yes'
- Offset (in bytes)
Set to '6' since the source MAC address starts at 7th octets we need to skip the first octets of the destination MAC address.
- Length (in bytes)
Set to '6' since MAC address has 6 octets.
- Mask (in hexadecimal)
Specify the value that the Prestige will logically qualify (logical AND) the data in the packet. Since the Length is set to 6 octets the Mask for it should be 12 hexadecimal numbers. In this case, we intent to set to 'ffffffff' to mask the incoming source MAC address, [00 80 c8 4c ea 63].
- Value (in hexadecimal)
Specify the MAC address **[00 80 c8 4c ea 63]** that the Prestige should use to compare with the masked packet. If the result from the masked packet matches the 'Value', then the packet is considered matched.

- Action Matched=
Enter the action you want if the masked packet matches the 'Value'. In this case, we will drop it.
- Action Not Matched=
Enter the action you want if the masked packet does not match the 'Value'. In this case, we will forward it. If you want to configure more rules please select 'Check Next Rule' to start configuring the next new rule. However, please note that the 'Filter Type' must be also 'Generic Filter Rule' but not others. Because the Generic and TCPIP (IPX) filter rules must be in different filter sets.

```
Menu 21.1.2 - Generic Filter Rule
Filter #: 1,2
Filter Type= Generic Filter Rule
Active= Yes
Offset= 6
Length= 6
Mask= ffffffff
Value= 0080c810234a
More= No          Log= None
Action Matched= Drop
Action Not Matched= Forward
```

You can now apply it to the ['General Ethernet Setup'](#) in Menu 3.1. Please note that the ['Generic Filter'](#) can only be applied to the ['Device Filter'](#) but not the ['Protocol Filter'](#) that is used for configuring the TCPIP and IPX filters.

```
Menu 3.1 - General Ethernet Setup
Input Filter Sets:
  protocol filters=
  device filters= 1
Output Filter Sets:
  protocol filters=
  device filters=
```

A filter for blocking the NetBIOS packets

- Introduction

The NETBIOS protocol is used to share a Microsoft computer of a workgroup. For the security concern, the NetBIOS connection to an outside host is blocked by Prestige router as factory defaults. Users can remove the filter sets applied to menu 3.1 and menu 4.1 for activating the NetBIOS services. The details of the filter settings are described as follows.

- Configuration

The packets need to be blocked are as follows. Please configure two filter sets with 4 and 2 rules respectively based on the following packets in SMT menu 21.

Filter Set 1:

- Rule 1-Destination port number 137 with protocol number 6 (TCP)
- Rule 2-Destination port number 137 with protocol number 17 (UDP)
- Rule 3-Destination port number 138 with protocol number 6 (TCP)
- Rule 4-Destination port number 138 with protocol number 17 (UDP)
- Rule 5-Destination port number 139 with protocol number 6 (TCP)
- Rule 6-Destination port number 139 with protocol number 17 (UDP)

Filter Set 2:

- Rule 1-Source port number 137, Destination port number 53 with protocol number 6 (TCP)
- Rule 2-Source port number 137, Destination port number 53 with protocol number 17 (UDP)

Before starting to set the filter rules, please enter a name for each filter set in the 'Comments' field first.

Menu 21 - Filter Set Configuration

Filter

Filter

Set #	Comments	Set #	Comments
1	NetBIOS_WAN	7	_____
2	NetBIOS_LAN	8	_____
3	_____	9	_____
4	_____	10	_____
5	_____	11	_____
6	_____	12	_____

Enter Filter Set Number to Configure= 1
Edit Comments=
Press ENTER to Confirm or ESC to Cancel:

Configure the first filter set 'NetBIOS_WAN' by selecting the Filter Set number 1.

- Rule 1-Destination port number 137 with protocol number 6 (TCP)

Menu 21.1.1 - TCP/IP Filter Rule
Filter #: 1,1
Filter Type= TCP/IP Filter Rule
Active= Yes
IP Protocol= 6 IP Source Route= No
Destination: IP Addr= 0.0.0.0
 IP Mask= 0.0.0.0
 Port #= 137
 Port # Comp= Equal
Source: IP Addr= 0.0.0.0
 IP Mask= 0.0.0.0
 Port #= 0
 Port # Comp= None
TCP Estab= No
More= No Log= None
Action Matched= Drop
 Action Not Matched= Check Next Rule
Press ENTER to Confirm or ESC to Cancel:

- Rule 2-Destination port number 137 with protocol number 17 (UDP)

```
Menu 21.1.2 - TCP/IP Filter Rule
Filter #: 1,2
Filter Type= TCP/IP Filter Rule
Active= Yes
IP Protocol= 17    IP Source Route= No
Destination: IP Addr= 0.0.0.0
                IP Mask= 0.0.0.0
                Port #= 137
                Port # Comp= Equal
Source: IP Addr= 0.0.0.0
        IP Mask= 0.0.0.0
        Port #= 0
        Port # Comp= None
TCP Estab= N/A
More= No          Log= None
Action Matched= Drop
Action Not Matched= Check Next Rule
Press ENTER to Confirm or ESC to Cancel:
```

- Rule 3-Destination port number 138 with protocol number 6 (TCP)

```
Menu 21.1.3 - TCP/IP Filter Rule
Filter #: 1,3
Filter Type= TCP/IP Filter Rule
Active= Yes
```

```
IP Protocol= 6      IP Source Route= No
Destination: IP Addr= 0.0.0.0
                IP Mask= 0.0.0.0
                Port #= 138
                Port # Comp= Equal
Source: IP Addr= 0.0.0.0
          IP Mask= 0.0.0.0
          Port #= 0
          Port # Comp= None

TCP Estab= No
More= No      Log= None
Action Matched= Drop
Action Not Matched= Check Next Rule

Press ENTER to Confirm or ESC to Cancel:
```

- Rule 4-Destination port number 138 with protocol number 17 (UDP)

```
Menu 21.1.4 - TCP/IP Filter Rule
Filter #: 1,4
Filter Type= TCP/IP Filter Rule
Active= Yes
IP Protocol= 17    IP Source Route= No
Destination: IP Addr= 0.0.0.0
                IP Mask= 0.0.0.0
                Port #= 138
                Port # Comp= Equal
Source: IP Addr= 0.0.0.0
          IP Mask= 0.0.0.0
          Port #= 0
          Port # Comp= None

TCP Estab= N/A
More= No      Log= None
```

```
Action Matched= Drop
Action Not Matched= Check Next Rule
Press ENTER to Confirm or ESC to Cancel:
```

- Rule 5-Destination port number 139 with protocol number 6 (TCP)

```
Menu 21.1.5 - TCP/IP Filter Rule
Filter #: 1,5
Filter Type= TCP/IP Filter Rule
Active= Yes
IP Protocol= 6      IP Source Route= No
Destination: IP Addr= 0.0.0.0
                IP Mask= 0.0.0.0
                Port #= 139
                Port # Comp= Equal
Source: IP Addr= 0.0.0.0
          IP Mask= 0.0.0.0
          Port #= 0
          Port # Comp= None
TCP Estab= No
More= No          Log= None
Action Matched= Drop
Action Not Matched= Check Next Rule
Press ENTER to Confirm or ESC to Cancel:
```

- Rule 6-Destination port number 139 with protocol number 17 (UDP)

```
Menu 21.1.6 - TCP/IP Filter Rule
Filter #: 1,6
```



```
Filter Type= TCP/IP Filter Rule
Active= Yes
IP Protocol= 17    IP Source Route= No
Destination: IP Addr= 0.0.0.0
                IP Mask= 0.0.0.0
                Port #= 139
                Port # Comp= Equal
Source: IP Addr= 0.0.0.0
          IP Mask= 0.0.0.0
          Port #= 0
          Port # Comp= None

TCP Estab= N/A
More= No          Log= None
Action Matched= Drop
Action Not Matched= Forward

Press ENTER to Confirm or ESC to Cancel:
```

- After the first filter set is finished, you will get the complete rules summary as below.

Menu 21.2 - Filter Rules Summary						
#	A	Type	Filter Rules	M	m	n
1	Y	IP	Pr=6, SA=0.0.0.0, DA=0.0.0.0, DP=137	N	D	N
2	Y	IP	Pr=17, SA=0.0.0.0, DA=0.0.0.0, DP=137	N	D	N
3	Y	IP	Pr=6, SA=0.0.0.0, DA=0.0.0.0, DP=138	N	D	N
4	Y	IP	Pr=17, SA=0.0.0.0, DA=0.0.0.0, DP=138	N	D	N
5	Y	IP	Pr=6, SA=0.0.0.0, DA=0.0.0.0, DP=139	N	D	N
6	Y	IP	Pr=17, SA=0.0.0.0, DA=0.0.0.0, DP=139	N	D	F

- Apply the first filter set 'NetBIOS_WAN' to the **'Output Protocol Filter'** in the remote node setup.

Configure the second filter set 'NetBIOS_LAN' by selecting the Filter Set number 2.

- Rule 1-Source port number 137, Destination port number 53 with protocol number 6 (TCP)

```
Menu 21.2.1 - TCP/IP Filter Rule
Filter #: 2,1
Filter Type= TCP/IP Filter Rule
Active= Yes
IP Protocol= 6      IP Source Route= No
Destination: IP Addr= 0.0.0.0
                IP Mask= 0.0.0.0
                Port #= 53
                Port # Comp= Equal
Source: IP Addr= 0.0.0.0
        IP Mask= 0.0.0.0
        Port #= 137
        Port # Comp= Equal
TCP Estab= No
More= No          Log= None
Action Matched= Drop
Action Not Matched= Check Next Rule
Press ENTER to Confirm or ESC to Cancel:
```

- Rule 2-Source port number 137, Destination port number 53 with protocol number 17 (UDP)

```
Menu 21.2.2 - TCP/IP Filter Rule
Filter #: 2,2
Filter Type= TCP/IP Filter Rule
Active= Yes
```

```
IP Protocol= 17    IP Source Route= No
Destination: IP Addr= 0.0.0.0
                IP Mask= 0.0.0.0
                Port #- 53
                Port # Comp= Equal
Source: IP Addr= 0.0.0.0
           IP Mask= 0.0.0.0
           Port #- 137
           Port # Comp= Equal
TCP Estab= N/A
More= No          Log= None
Action Matched= Drop
Action Not Matched= Forward
Press ENTER to Confirm or ESC to Cancel:
```

1. After the first filter set is finished, you will get the complete rules summary as below.

```
Menu 21.2 - Filter Rules Summary
# A Type          Filter Rules          M m n
-----
1 Y IP   Pr=6, SA=0.0.0.0, SP=137, DA=0.0.0.0, DP=53  N D N
2 Y IP   Pr=17, SA=0.0.0.0, SP=137, DA=0.0.0.0, DP=53  N D F
```

1. Apply the filter set 'NetBIOS_LAN' in the **'Input protocol filters='** in the Menu 3 for blocking the packets from LAN

Menu 3.1 - General Ethernet Setup

Input Filter Sets:

```
protocol filters= 2
device filters=
Output Filter Sets:
protocol filters=
device filters=
```

Using the Dynamic DNS (DDNS)

1. What is DDNS?

The DDNS service, an IP Registry provides a public central database where information such as email addresses, hostnames, IPs etc. can be stored and retrieved. This solves the problems if your DNS server uses an IP associated with dynamic IPs.

Without DDNS, we always tell the users to use the WAN IP of the Prestige to access the internal server. It is inconvenient for the users if this IP is dynamic. With DDNS supported by the Prestige, you apply a DNS name (e.g., www.zyxel.com.tw) for your server (e.g., Web server) from a DDNS server. The outside users can always access the web server using the www.zyxel.com.tw regardless of the WAN IP of the Prestige.

When the ISP assigns the Prestige a new IP, the Prestige must inform the DDNS server the change of this IP so that the server can update its IP-to-DNS entry. Once the IP-to-DNS table in the DDNS server is updated, the DNS name for your web server (i.e., www.zyxel.com.tw) is still usable.

The DDNS server stores password-protected email addresses with IPs and hostnames and accepts queries based on email addresses. So, there must be an email entry in the Prestige menu 1.

The DDNS servers the Prestige supports currently is WWW.DYNDNS.ORG where you apply the DNS from and update the WAN IP to.

- Setup the DDNS
- Before configuring the DDNS settings in the Prestige, you must register an account from the DDNS server such as WWW.DYNDNS.ORG first. After the registration, you have a hostname for your internal server and a password using to update the IP to the DDNS server.
- Toggle '**Configure Dynamic DNS**' option to '**Yes**' and press ENTER for configuring the settings of the DDNS in menu 1.1.

Menu 1 - General Setup

System Name= Prestige
 Location=
 Contact Person's Name=
 Domain Name=
 Edit Dynamic DNS= **Yes**

Route IP= Yes
 Bridge= No

Menu 1.1 - Configure Dynamic DNS

Service Provider= WWW.DynDNS.ORG
 Active= **Yes**
 Host=[**the local server's host name**]
 EMAIL=
 USER=
 Password= *****
 Enable Wildcard= No

Key Settings for using DDNS function:

Option	Description
Service Provider	Enter the DDNS server in this field. Currently, we support WWW.DYNDNS.ORG .
Active	Toggle to 'Yes'.
Host	Enter the hostname you subscribe from the above DDNS server. For example, zyxel.com.tw.
EMAIL	Enter the email address you give to the DDNS server.
User	Enter the user name that

Password	Enter the password that the DDNS server gives to you.
Enable Wildcard	Enter the hostname for the wildcard function that the WWW.DYNDNS.ORG supports. Note that Wildcard option is available only when the provider is WWW.DYNDNS.ORG .

Network Management Using SNMP

1. *SNMP Overview*

The *Simple Network Management Protocol* (SNMP) is an applications-layer protocol used to exchange the management information between network devices (e.g., routers). By using SNMP, network administrators can more easily manage network performance, find and solve network problems. The SNMP is a member of the TCP/IP protocol suite, it uses the UDP to exchange messages between a management Client and an Agent, residing in a network node.

There are two versions of SNMP: Version 1 and Version 2. ZyXEL supports SNMPv1. Most of the changes introduced in Version 2 increase SNMP's security capabilities. SNMP encompasses three main areas:

1. A small set of management operations.
2. Definitions of management variables.
3. Data representation.

The operations allowed are: **Get**, **GetNext**, **Set**, and **Trap**. These functions operates on variables that exist in network nodes. Examples of variables include statistic counters, node port status, and so on. All of the SNMP management functions are carried out through these simple operations. No action operations are available, but these can be simulated by the setting of flag variables. For example, to reset a node, a counter variable named 'time to reset' could be set to a value, causing the node to reset after the time had elapsed.

SNMP variables are defined using the OSI Abstract Syntax Notation One (ASN.1). ASN.1 specifies how a variable is encoded in a transmitted data frame; it is very powerful because the encoded data is self-defining. For example, the encoding of a text string includes an indication that the data unit is a string, along with its length and value. ASN.1 is a flexible way of defining protocols, especially for network management protocols where nodes may support different sets of manageable variables.

The net of variables that each node supports is called the *Management Information Base* (MIB). The MIB is made up of several parts, including the Standard MIB, specified as part of SNMP, and Enterprise Specific MIB, which are defined by different manufacturer for hardware specific management.

The current Internet-standard MIB, MIB-II, is defined in RFC 1213 and contains 171 objects. These objects are grouped by protocol (including TCP, IP, UDP, SNMP, and other categories, including 'system' and 'interface.')

The Internet Management Model is as shown in figure 1. Interactions between the NMS and managed devices can be any of four different types of commands:

6. Reads

Read is used to monitor the managed devices, NMSs read variables that are maintained by the devices.

7. Writes

Write is used to control the managed devices, NMSs write variables that are stored in the managed devices.

8. Traversal operations

NMSs use these operations to determine which variables a managed device supports and to sequentially gather information from variable tables (such as IP routing table) in managed devices.

9. Traps

The managed devices to asynchronously report certain events to NMSs use trap.

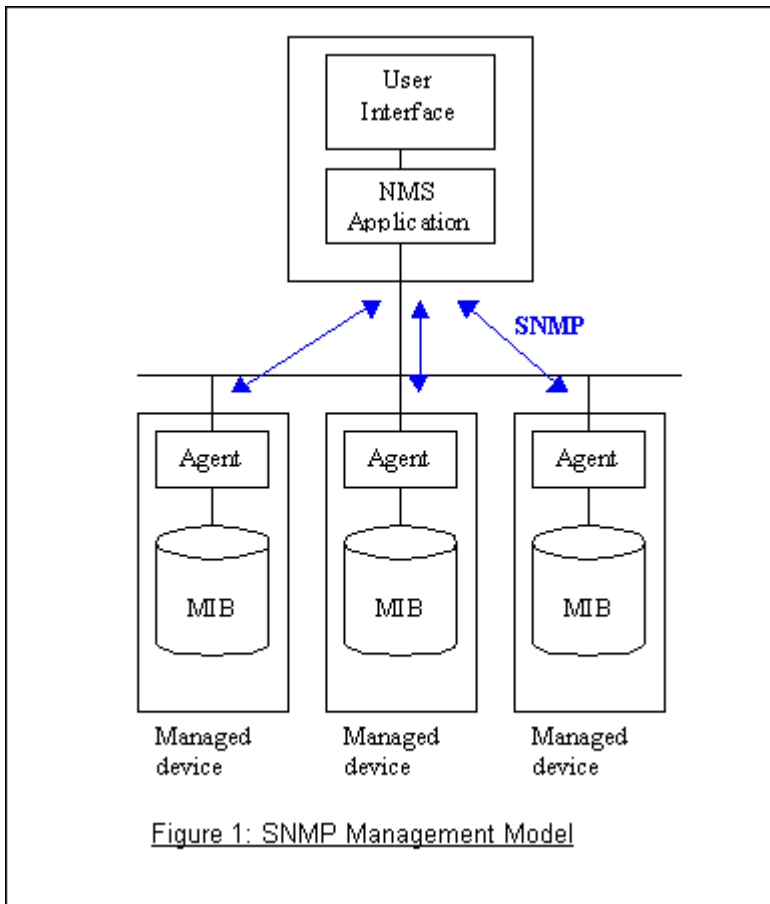

2. *SNMPv1 Operations*

SNMP itself is a simple request/response protocol. 4 SNMPv1 operations are defined as below.

- **Get**
Allows the NMS to retrieve an object variable from the agent.
- **GetNext**
Allows the NMS to retrieve the next object variable from a table or list within an agent. In SNMPv1, when a NMS wants to retrieve all elements of a table from an agent, it initiates a Get operation, followed by a series of GetNext operations.
- **Set**
Allows the NMS to set values for object variables within an agent.
- **Trap**
Used by the agent to inform the NMS of some events.

The SNMPv1 messages contains two part. The first part contains a version and a community name. The second part contains the actual SNMP protocol data unit (PDU) specifying the operation to be performed (Get, Set, and

so on) and the object values involved in the operation. The following figure shows the SNMPv1 message format.

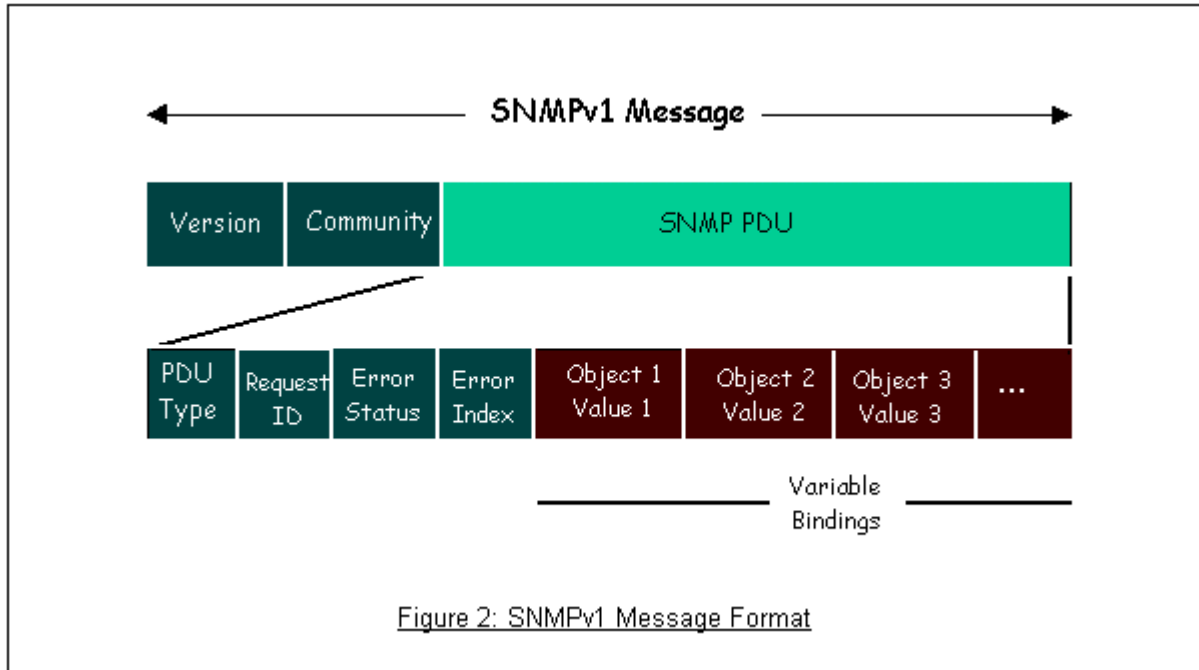

Figure 2: SNMPv1 Message Format

The SNMP PDU contains the following fields:

- **PDU type** Specifies the type of PDU.
- **Request ID** Associates requests with responses.
- **Error status** Indicates an error and an error type.
- **Error index** Associates the error with a particular object variable.
- **Variable-bindings** Associates particular object with their value.

3. ZyXEL SNMP Implementation

ZyXEL currently includes SNMP support in some Prestige routers. It is implemented based on the SNMPv1, so it will be able to communicate with SNMPv1 NMSs. For SNMPv1 operation, ZyXEL permits one community string so that the router can belong to only one community and allows trap messages to be sent to only one NMS manager.

Some traps are sent to the SNMP manager when anyone of the following events happens:

- coldStart (defined in RFC-1215) :

If the machine coldstarts, the trap will be sent after booting.

- **warmStart** (defined in RFC-1215) :

If the machine warmstarts, the trap will be sent after booting.

- **linkDown** (defined in RFC-1215) :

If any link of IDSL or WAN is down, the trap will be sent with the port number . The port number is its interface index under the interface group.

- **linkUp** (defined in RFC-1215) :

If any link of IDSL or WAN is up, the trap will be sent with the port number . The port number is its interface index under the interface group.

- **authenticationFailure** (defined in RFC-1215) :

When receiving any SNMP get or set requirement with wrong community, this trap is sent to the manager.

1. **whyReboot** (defined in ZYXEL-MIB) :

When the system is going to restart (warmstart), the trap will be sent with the reason of restart before rebooting.

(i) For intentional reboot :

In some cases (download new files, CI command "sys reboot", ...), reboot is done intentionally. And traps with the message "System reboot by user !" will be sent.

(ii) For fatal error :

System has to reboot for some fatal errors. And traps with the message of the fatal code will be sent.

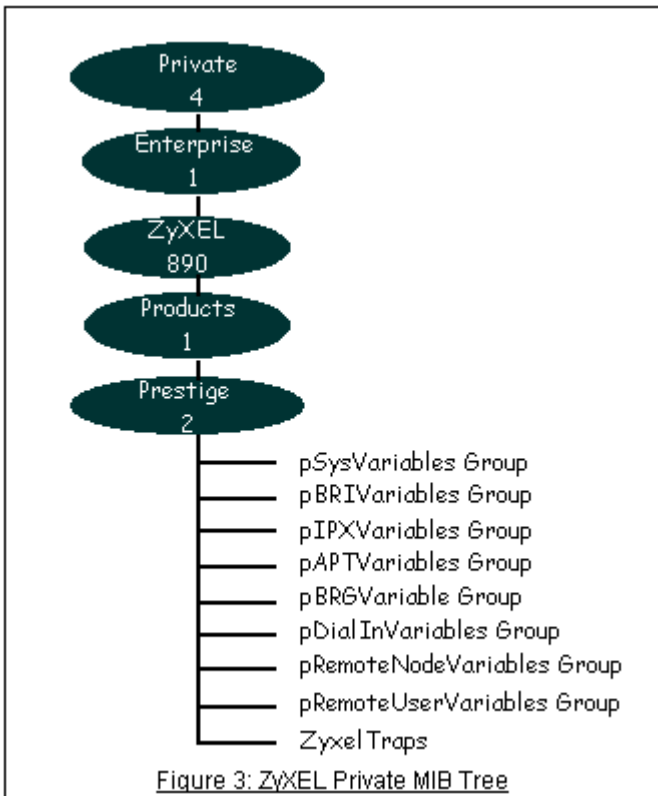

4. Configure the Prestige for SNMP

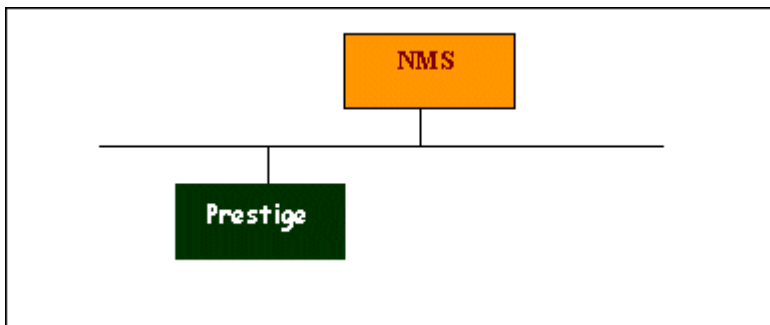

The SNMP related settings in Prestige are configured in menu 22, SNMP Configuration. The following steps describe a simple setup procedure for configuring all SNMP settings.

```
Menu 22 - SNMP Configuration
SNMP:
  Get Community= public
  Set Community= public
  Trusted Host= 192.168.1.33
```

```

Trap:
Community= public
Destination= 192.168.1.33

Press ENTER to Confirm or ESC to Cancel:
    
```

Key Settings:

Option	Descriptions
Get Community	Enter the correct Get Community. This Get Community must match the 'Get-' and 'GetNext' community requested from the NMS. The default is 'public'.
Set Community	Enter the correct Set Community. This Set Community must match the 'Set-community requested from the NMS. The default is 'public'.
Trusted Host	Enter the IP address of the NMS. The Prestige will only respond to SNMP messages coming from this IP address. If 0.0.0.0 is entered, the Prestige will respond to all NMS managers.
Trap Community	Enter the community name in each sent trap to the NMS. This Trap Community must match what the NMS is expecting. The default is 'public'.
Trap Destination	Enter the IP address of the NMS that you wish to send the traps to. If 0.0.0.0 is entered, the Prestige will not send trap any NMS manager.

Using syslog

4. Prestige Setup

```

Menu 24.3.2 - System Maintenance - UNIX Syslog and Accounting
UNIX Syslog:
Active= Yes
Syslog IP Address= 192.168.1.33
Log Facility= Local 1
    
```

Configuration:

1. **Active**, use the space bar to turn on the syslog option.
2. **Syslog IP Address**, enter the IP address of the UNIX server that you wish to send the syslog.
3. **Log Facility**, use the space bar to toggle between the 7 different local options.

- **UNIX Setup**

1. Make sure that your syslogd starts with **-r** argument.

-r, this option will enable the facility to receive message from the network using an Internet domain socket with the syslog services. The default setting is not enabled.

2. Edit the file [/etc/syslog.conf](#) by adding the following line at the end of the [/etc/syslog.conf](#) file.

```
local1.*                /var/log/zyxel.log
```

Where [/var/log/zyxel.log](#) is the full path of the log file.

3. Restart syslogd.

- **CDR log(call messages)**

Format:

```
sdcmdSyslogSend( SYSLOG_CDR, SYSLOG_INFO, String );
```

String = board xx line xx channel xx, call xx, str

board = the hardware board ID

line = the WAN ID in a board

channel = channel ID within the WAN

call = the call reference number which starts from 1 and increments by 1 for each new call

str = C01 Outgoing Call dev xx ch xx (dev:device No. ch:channel No.)

C01 Incoming Call xxxxBps xxxxx (L2TP,xxxxx means Remote Call ID)

C01 Incoming Call xxxx (means connected speed) xxxxx (means Remote Call ID)

L02 Tunnel Connected(L2TP)

C02 OutCall Connected xxxx (means connected speed) xxxxx (means Remote Call ID)

C02 CLID call refused

L02 Call Terminated

C02 Call Terminated

Example:

```
Feb 14 16:57:17 192.168.1.1 ZyXEL Communications Corp.: board 0 line 0 channel 0, call 18, C01 Incoming Call OK
Feb 14 17:07:18 192.168.1.1 ZyXEL Communications Corp.: board 0 line 0 channel 0, call 18, C02 Call Terminated
```

- **Packet triggered log**

Format:

```
sdcmdSyslogSend( SYSLOG_PKTTRI, SYSLOG_NOTICE, String );
```

String = Packet trigger: Protocol=xx Data=xxxxxxxxxx

Protocol: (1:IP 2:IPX 3:IPXHC 4:BPDU 5:ATALK 6:IPNG)

Data: We will send forty-eight Hex characters to the server

Example:

```
Jul 19 11:28:39 192.168.102.2 ZyXEL Communications Corp.: Packet Trigger: Protocol=1,
Data=4500003c100100001f010004c0a86614ca849a7b08004a5c0200010061626364656666768696a6b6c6d6e6f7071727374
Jul 19 11:28:56 192.168.102.2 ZyXEL Communications Corp.: Packet Trigger: Protocol=1,
Data=4500002c1b0140001f06b50ec0a86614ca849a7b0427001700195b3e00000000600220008cd40000020405b4
```

- **Filter log**

This message is available when the **Log** is enabled in the filter rule setting. The message consists of the packet header and the log of the filter rules.

Format:

```
sdcmdSyslogSend(SYSLOG_FILLOG, SYSLOG_NOTICE, String );
```

String = IP[Src=xx.xx.xx.xx Dst=xx.xx.xx.xx prot spo=xxxx dpo=xxxx]S04>R01mD

IP[...] is the packet header and S04>R01mD means filter set 4 (S) and rule 1 (R), match (m) drop (D).

Src: Source Address

Dst: Destination Address

prot: Protocol (TCP,UDP,ICMP)

spo: Source port

dpo: Destination port

Example:

```
Jul 19 14:44:09 192.168.1.1 ZyXEL Communications Corp.: IP[Src=202.132.154.1 Dst=192.168.1.33 UDP
spo=0035 dpo=05d4]}S03>R01mF
Jul 19 14:44:13 192.168.1.1 ZyXEL Communications Corp.: IP[Src=192.168.1.33 Dst=202.132.154.1
ICMP]}S03>R01mF
```

- **PPP Log**

Format:

```
sdcmdSyslogSend( SYSLOG_PPPLOG, SYSLOG_NOTICE, String );
```

String = ppp:Proto Starting / ppp:Proto Opening / ppp:Proto Closing / ppp:Proto Shutdown

Proto = LCP / ATCP / BACP / BCP / CBCP / CCP / CHAP/ PAP / IPCP /IPXCP

Example:

```
Jul 19 11:43:25 192.168.1.1 ZyXEL Communications Corp.: ppp:LCP Starting
Jul 19 11:43:29 192.168.1.1 ZyXEL Communications Corp.: ppp:IPCP Starting
Jul 19 11:43:34 192.168.1.1 ZyXEL Communications Corp.: ppp:CCP Starting
Jul 19 11:43:38 192.168.1.1 ZyXEL Communications Corp.: ppp:BACP Starting
Jul 19 11:43:43 192.168.1.1 ZyXEL Communications Corp.: ppp:IPCP Opening
Jul 19 11:43:51 192.168.1.1 ZyXEL Communications Corp.: ppp:CCP Opening
Jul 19 11:43:55 192.168.1.1 ZyXEL Communications Corp.: ppp:BACP Opening
Jul 19 11:44:00 192.168.1.1 ZyXEL Communications Corp.: ppp:LCP Closing
Jul 19 11:44:05 192.168.1.1 ZyXEL Communications Corp.: ppp:IPCP Closing
Jul 19 11:44:09 192.168.1.1 ZyXEL Communications Corp.: ppp:CCP Closing
Jul 19 11:44:14 192.168.1.1 ZyXEL Communications Corp.: ppp:BACP Closing
```

Using IP Alias

- What is IP Alias ?

In a typical environment, a LAN router is required to connect two local networks. The Prestige can connect three local networks to the ISP or a remote node, we call this function as 'IP Alias'. In this case, an internal router is not required. For example, the network manager can divide the local network into three networks and connect them to the Internet using Prestige's single user account. See the figure below.

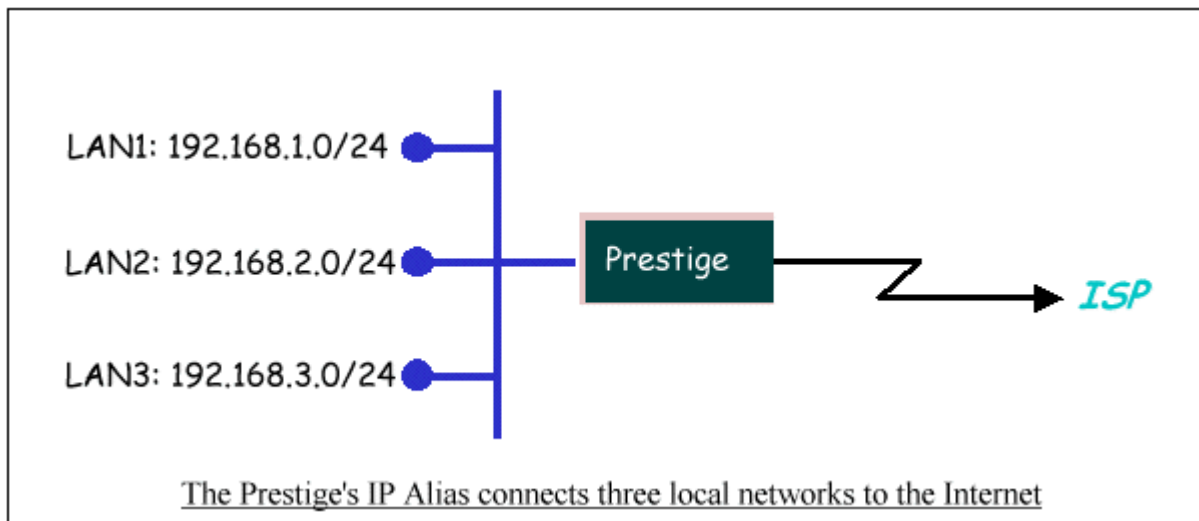

The Prestige supports three virtual LAN interfaces via its single physical Ethernet interface. The first network can be configured in menu 3.2 as usual. The second and third networks that we call 'IP Alias 1' and 'IP Alias 2' can be configured in menu 3.2.1-IP Alias Setup.

There are three internal virtual LAN interfaces for the Prestige to route the packets from/to the three networks correctly. They are **enif0** for the major network, **enif0:0** for the IP alias 1 and **enif0:1** for the IP alias 2. Therefore, three routes are created in the Prestige as shown below when the three networks are configured. If the Prestige's DHCP is also enabled, the IP pool for the clients can be any of the three networks.

```
Copyright (c) 1994 - 2004 ZyXEL Communications Corp.
ras> ip ro st
Dest          FF Len Interface Gateway      Metric stat Timer Use
192.168.3.0   00 24  enif0:1    192.168.3.1    1    041b 0    0
192.168.2.0   00 24  enif0:0    192.168.2.1    1    041b 0    0
192.168.1.0   00 24  enif0      192.168.1.1    1    041b 0    0
ras>
```

Two new protocol filter interfaces in menu 3.2.1 allow you to accept or deny LAN packets from/to the IP alias 1 and IP alias 2 go through the Prestige. The filter set in menu 3.1 is used for main network configured in menu 3.2.

- **IP Alias Setup**

1. Edit the first network in menu 3.2 by configuring the Prestige's first LAN IP address.

```
Menu 3.2 - TCP/IP and DHCP Setup

DHCP Setup
DHCP= Server
Client IP Pool Starting Address= 192.168.1.33
Size of Client IP Pool= 32
Primary DNS Server= 0.0.0.0
Secondary DNS Server= 0.0.0.0
Remote DHCP Server= N/A

TCP/IP Setup:
IP Address= 192.168.1.1
IP Subnet Mask= 255.255.255.0
RIP Direction= None
Version= N/A
Multicast= None
IP Policies=
Edit IP Alias= Yes

Press ENTER to Confirm or ESC to Cancel:
```

Key Settings:

DHCP Setup	If the Prestige's DHCP server is enabled, the IP pool for the clients can be any of the three networks.
TCP/IP Setup	Enter the first LAN IP address for the Prestige. This will create the first route in the enif0 interface.

Edit IP Alias	Toggle to 'Yes' to enter menu 3.2.1 for setting up the second and third networks.
----------------------	------------------------------------------------------------------------------------------

2. Edit the second and third networks in menu 3.2.1 by configuring the Prestige's second and third LAN IP addresses.

```

Menu 3.2.1 - IP Alias Setup
IP Alias 1= Yes
  IP Address= 192.168.2.1
  IP Subnet Mask= 255.255.255.0
  RIP Direction= None
  Version= RIP-1
  Incoming protocol filters=
  Outgoing protocol filters=
IP Alias 2= Yes
  IP Address= 192.168.3.1
  IP Subnet Mask= 255.255.255.0
  RIP Direction= None
  Version= RIP-1
  Incoming protocol filters=
  Outgoing protocol filters=

Enter here to CONFIRM or ESC to CANCEL:
    
```

Key Settings:

IP Alias 1	Toggle to 'Yes' and enter the second LAN IP address for the Prestige. This will create the second route in the enif0:0 interface.
IP Alias 2	Toggle to 'Yes' and enter the third LAN IP address for the Prestige. This will create the third route in the enif0:1 interface.

Using Call Scheduling

1. What is Call Scheduling ?

Call scheduling enables the mechanism for the Prestige to run the remote node connection according to the pre-defined schedule. This feature is just like the scheduler in a video recorder which records the program according to the specified time. Users can apply at most 4 schedule sets in Menu 11 (Remote Node Setup), and configure each schedule in Menu 26(Schedule Setup). The remote node configured with the schedule set could be "Forced On", "Forced Down", "Enable Dial-On-Demand", or "Disable Dial-On-Demand" on specified date and time.

- **SMT Menu for Call Scheduling**

1. Edit the Schedule sets in menu 26:

```
Prestige 2602R-61 Main Menu

Getting Started
  1. General Setup
  2. WAN Backup Setup
  3. LAN Setup
  4. Internet Access Setup

Advanced Applications
  11. Remote Node Setup
  12. Static Routing Setup
  15. NAT Setup

Advanced Management
  21. Filter Set Configuration
  22. SNMP Configuration
  23. System Password
  24. System Maintenance
  25. IP Routing Policy Setup
  26. Schedule Setup

99. Exit

Enter Menu Selection Number:
```

2. Select a Schedule Set number and give it a name:

```
Menu 26 - Schedule Setup

Schedule          Schedule
Set # Name        Set # Name
-----
1 ZyXEL           7 _____
2 _____      8 _____
3 _____      9 _____
```

4 _____ 10 _____
5 _____ 11 _____
6 _____ 12 _____

Enter Schedule Set Number to Configure= 1

Edit Name= ZyXEL

Press ENTER to Confirm or ESC to Cancel:

3. The Menu 26.1 Schedule Set Setup is as follows:

Menu 26.1 Schedule Set Setup

Active= Yes

Start Date(yyyy-mm-dd)= 2004 - 01 - 01

How Often= Once

Once:

Date(yyyy-mm-dd)= 2004 - 01 - 01

Weekdays:

Sunday= N/A

Monday= N/A

Tuesday= N/A

Wednesday= N/A

Thursday= N/A

Friday= N/A

Saturday= N/A

Start Time(hh:mm)= 12 : 00

Duration(hh:mm)= 16 : 00

Action= Enable Dial-on-demand

Press ENTER to Confirm or ESC to Cancel:

Key Settings:

Start Date	Start date of this schedule rule. It can be unmatched with weekday setting. For example, if Start Date is 2004/10/02(Monday), but Monday setting in weekday can be No.
How Often	If once is selected, all weekday settings will ne marked as N/A. After the rule is completely, it will be deleted automatically.
Forced On	The node will always keep up during the setting period. It is equivalent to diable the idel timeout.
Forced Down	The node will always keep doen during the setting period. The connected remote node will be dropped.
Enable Dial-On-Demand	The remote node accepts Dial-on-demand during this period.
Disable Dial-On-Demand	The remote node denies any demand dial during the period. For the existing connected nodes, it will be dropped after idle timeout and no triggered up.
Start Time/Duration	Start Time and Duration of this schedule.

- Apply the schedule to the Remote node

Multiple scheduling rules can program in a Remote node, and they have priority. For example, if we program the sets as 1,2,3,4 in remote node, then the set 1 will override set 2,3,4. set 2 will override 3,4, and so on.

Menu 11.1 - Remote Node Profile

```

Rem Node Name= MyISP                Route= IP
Active= Yes

Encapsulation= PPPoE                Edit IP= No
Service Type= Standard              Telco Option:
Service Name=                        Allocated Budget(min)= 0
Outgoing:                            Period(hr)= 0
  My Login= cso@zyxel                Schedules= 1,2,3,4
  My Password= *****              Nailed-Up Connection= No
  Retype to Confirm= *****
  Authen= CHAP/PAP

```

Session Options:

Edit Filter Sets= No

Idle Timeout(sec)= 100

Edit Traffic Redirect= No

Press ENTER to Confirm or ESC to Cancel:

- **Time Service in Prestige**

There is no RTC (Real-Time Clock) chip so the Prestige should launch a mechanism to get current time and date from external server in boot time. Time service is implemented by the **Daytime protocol(RFC-867)**, **Time protocol(RFC-868)**, and **NTP protocol(RFC-1305)**. You have to assign an IP address of a time server and then, the Prestige will get the date, time, and time-zone information from this server.

Menu 24.10 - System Maintenance - Time and Date Setting

Use Time Server when Bootup= **Daytime (RFC-867)**

Time Server IP Address= **202.132.154.1**

Current Time: 00 : 11 : 38

New Time (hh:mm:ss): 00 : 11 : 36

Current Date: 2004 - 01 - 01

New Date (yyyy-mm-dd): 2004 - 01 - 01

Time Zone= **GMT+0800**

Daylight Saving= No

Start Date (mm-dd): 01 - 00

End Date (mm-dd): 01 - 00

Press ENTER to Confirm or ESC to Cancel:

Using IP Multicast

- What is IP Multicast ?

Traditionally, IP packets are transmitted in two ways - unicast or broadcast. Multicast is a third way to deliver IP packets to a group of hosts. Host groups are identified by class D IP addresses, i.e., those with "1110" as their higher-order bits. In dotted decimal notation, host group addresses range from 224.0.0.0 to 239.255.255.255. Among them, 224.0.0.1 is assigned to the permanent IP hosts group, and 224.0.0.2 is assigned to the multicast routers group.

IGMP (Internet Group Management Protocol) is the protocol used to support multicast groups. The latest version is version 2 (see RFC2236). IP hosts use IGMP to report their multicast group membership to any immediate-neighbor multicast routers so the multicast routers can decide if a multicast packet needs to be forwarded. At start up, the Prestige queries all directly connected networks to gather group membership.

After that, the Prestige updates the information by periodic queries. The Prestige implementation of IGMP is also compatible with version 1. The multicast setting can be turned on or off on Ethernet and remote nodes.

- IP Multicast Setup

Enable IGMP in Prestige's LAN in menu 3.2:

Menu 3.2 - TCP/IP and DHCP Setup

DHCP Setup

DHCP= Server

Client IP Pool Starting Address= 192.168.1.33

Size of Client IP Pool= 32

Primary DNS Server= 0.0.0.0

Secondary DNS Server= 0.0.0.0

Remote DHCP Server= N/A

TCP/IP Setup:

IP Address= 192.168.1.1

IP Subnet Mask= 255.255.255.0
RIP Direction= Both
Version= RIP-2B
Multicast= **IGMP-v2**
IP Policies=
Edit IP Alias= No

Press ENTER to Confirm or ESC to Cancel:

Enable IGMP in Prestige's remote node in menu 11.3:

Menu 11.3 - Remote Node Network Layer Options

IP Options:

IP Address Assignment = Dynamic
Rem IP Addr = 0.0.0.0
Rem Subnet Mask= 0.0.0.0
My WAN Addr= N/A
NAT= SUA Only
Address Mapping Set= N/A
Metric= 2
Private= No
RIP Direction= None
Version= RIP-2B
Multicast= **IGMP-v2**
IP Policies=

Bridge Options:

Ethernet Addr Timeout(min)= N/A

Enter here to CONFIRM or ESC to CANCEL:

Key Settings:

Multicast	IGMP-v1 for IGMP version 1, IGMP-v2 for IGMP version 2.
------------------	---------------------------------------------------------

Using Prestige traffic redirect

- What is Traffic Redirect ?

Traffic redirect forwards WAN traffic to a backup gateway when Prestige cannot connect to the Internet through its normal gateway. Thus make your backup gateway as an auxiliary backup of your WAN connection. Once Prestige detects its WAN connectivity is broken, Prestige will try to forward outgoing traffic to backup gateway that users specify in traffic redirect configuration menu.

- How to deploy backup gateway?

You can deploy the backup gateway on LAN of Prestige.

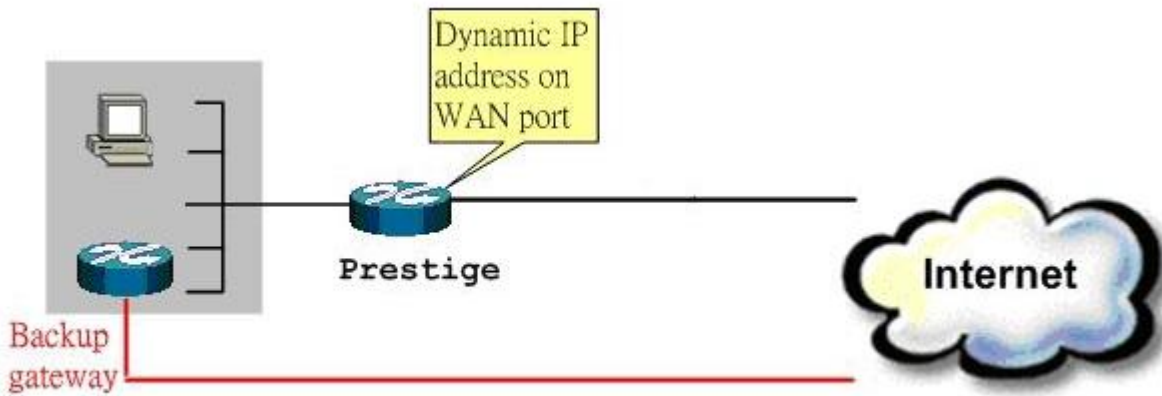

Traffic Redirect on LAN port

- Traffic Redirect Setup

Configure parameters that determine when Prestige will forward WAN traffic to the backup gateway using SMT Menu 2 WAN Backup Setup.

Menu 2 - Wan Backup Setup

Menu 2 - Wan Backup Setup

Check Mechanism = [DSL Link](#)
 Check WAN IP Address1 = 0.0.0.0
 Check WAN IP Address2 = 0.0.0.0
 Check WAN IP Address3 = 0.0.0.0
 KeepAlive Fail Tolerance = [5](#)
 Recovery Interval(sec) = [60](#)
 ICMP Timeout(sec) = 0
 Traffic Redirect = [Yes](#)

Key Settings:

Label	Description
Backup Type	Select the method that the Prestige uses to check the DSL connection. Select DSL Link to have the Prestige check if the connection to the DSLAM is up. Select ICMP to have the Prestige periodically ping the IP addresses configured in the Check WAN IP Address fields.
Check WAN IP Address1-3	Configure this field to test your Prestige's WAN accessibility. Type the IP address of a reliable nearby computer (for example, your ISP's DNS server address). If you select ICMP in the Backup Type field, you must configure at least one IP address here. When using a WAN backup connection, the Prestige periodically pings the addresses configured here and uses the other WAN backup connection (if configured) if there is no response.
Fail Tolerance	Type the number of times (2 recommended) that your Prestige may ping the IP addresses configured in the Check WAN IP Address fields without getting a response before switching to a WAN backup connection (or a different WAN backup connection).
Recovery Interval	When the Prestige is using a lower priority connection (usually a WAN backup connection), it periodically checks to whether or not it can use a higher priority connection. Type the number of seconds (30 recommended) for the Prestige to wait between checks. Allow more time if your destination IP address handles lots of traffic.
Timeout	Type the number of seconds (3 recommended) for your Prestige to wait for a ping response from one of the IP addresses in the Check WAN IP Address fields before timing out the request. The WAN connection is considered "down" after the Prestige times out the number of times specified in the Fail Tolerance field. Use a higher value in this field if your network is busy or congested.
Traffic	

Label	Description
Redirect	
Active	<p>Select this check box to have the Prestige use traffic redirect if the normal WAN connection goes down.</p> <p>If you activate traffic redirect, you must configure at least one Check WAN IP Address.</p>
Metric	<p>This field sets this route's priority among the routes the Prestige uses.</p> <p>The metric represents the "cost of transmission". A router determines the best route for transmission by choosing a path with the lowest "cost". RIP routing uses hop count as the measurement of cost, with a minimum of "1" for directly connected networks. The number must be between "1" and "15"; a number greater than "15" means the link is down. The smaller the number, the lower the "cost".</p>
Backup Gateway	<p>Type the IP address of your backup gateway in dotted decimal notation. The Prestige automatically forwards traffic to this IP address if the Prestige's Internet connection terminates.</p>
Back	<p>Click Back to return to the previous screen.</p>
Apply	<p>Click Apply to save the changes.</p>
Cancel	<p>Click Cancel to begin configuring this screen afresh.</p>

You can also configure traffic redirect via web configuration. The configuration page is in **WAN/WAN Backup**.

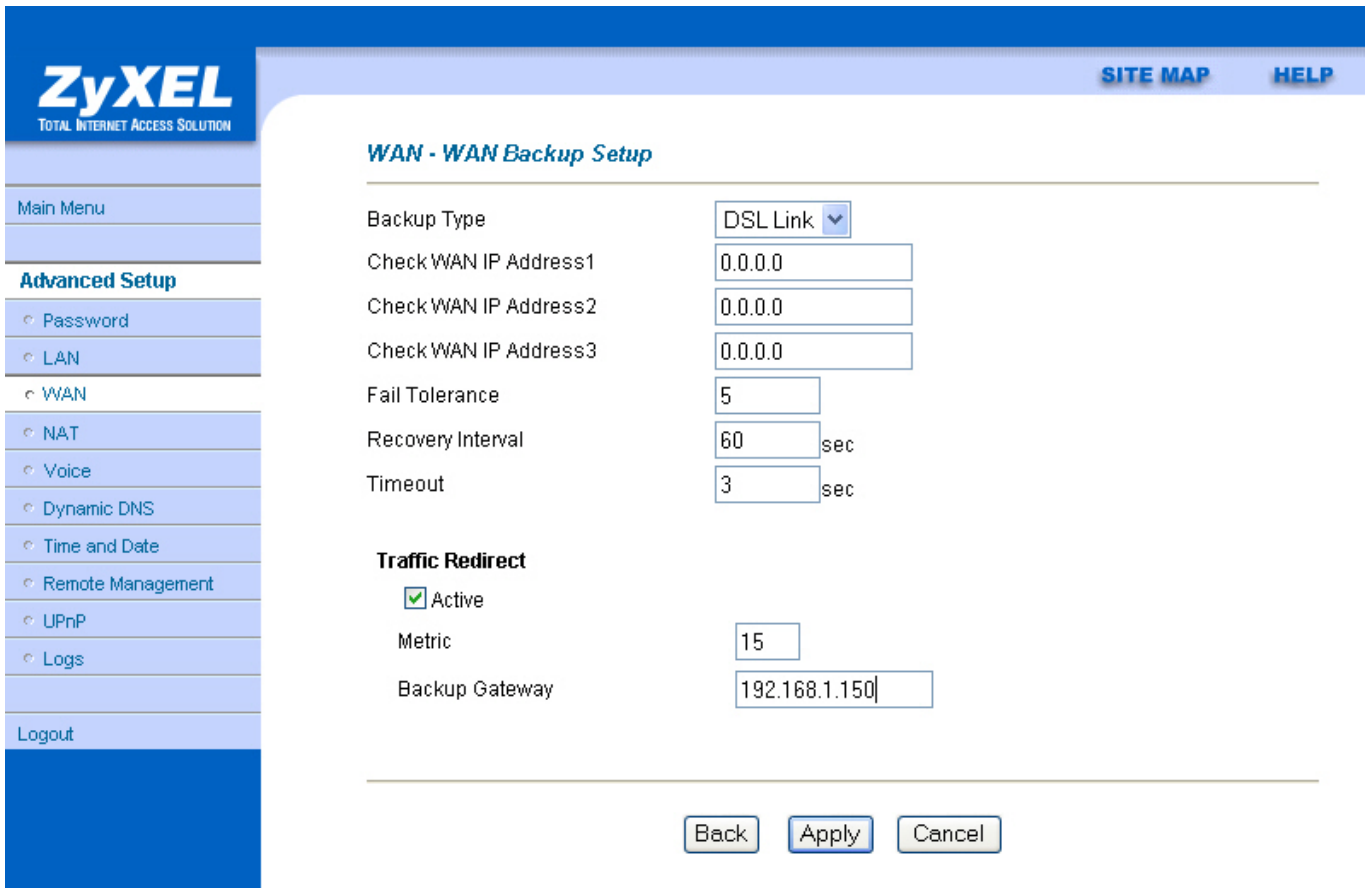

Using Universal Plug n Play (UPnP)

- **1. What is UPnP**

UPnP (Universal Plug and Play) makes connecting PCs of all form factors, intelligent appliances, and wireless devices in the home, office, and everywhere in between easier and even automatic by leveraging TCP/IP and Web technologies. UPnP can be supported on essentially any operating system and works with essentially any type of physical networking media – wired or wireless.

UPnP also supports NAT Traversal which can automatically solve many NAT unfriendly problems. By UPnP, applications assign the dynamic port mappings to Internet gateway and delete the mappings when the connections are complete.

The key components in UPnP are devices, services, and control points.

- **Devices:** Network devices, such as networking gateways, TV, refrigerators, printers...etc, which provides services.
- **Services:** Services are provided by devices, such as time services provided by alarm clocks. In UPnP, services are described in XML format. Control points can set/get services information from devices.
- **Control points:** Control points can manipulate network devices. When you add a new control point (in this case, a laptop) to a network, the device may ask the network to find UPnP-enabled devices. These devices respond with their URLs and device descriptions.

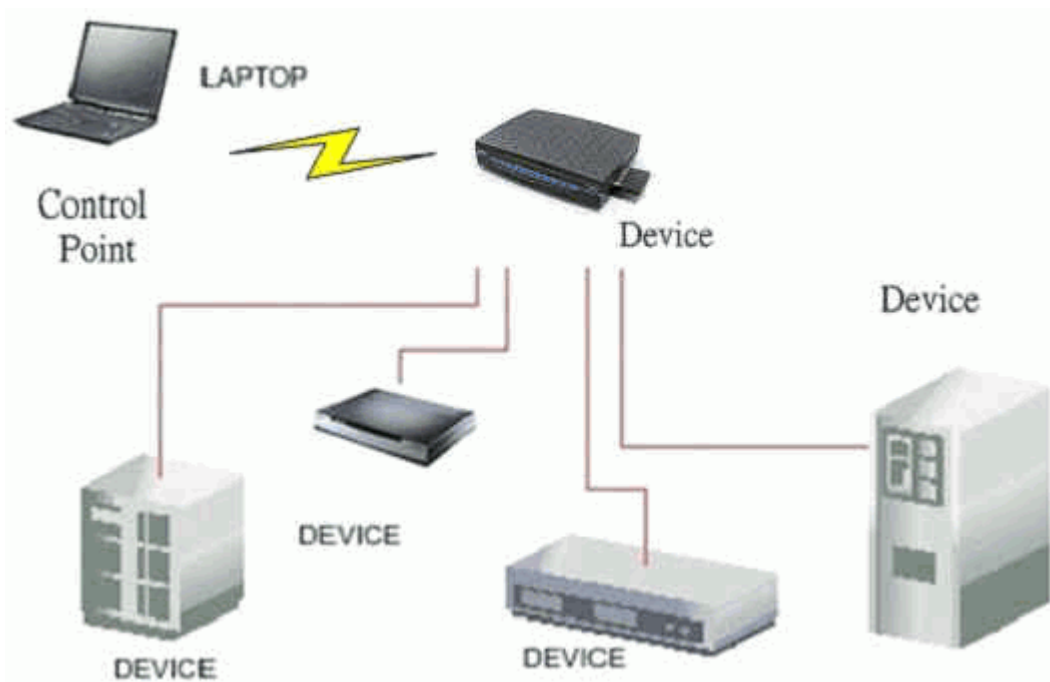

UPnP Operations

- **Addressing:** UPnPv1 devices MAY support IPv4, IPv6, or both. For IPv4, each device should have DHCP client, when the device gets connected to the network, it will discover DHCP server on network to get an IP address. If not, then Auto-IP mechanism should be supported so that the device can give itself an IP address.(169.254.0.0/16)
- **Discovery:** Whenever a device is added on the network, it will advertise its service over the network. Control point can also discover services provided by devices.
- **Description:** Control points can get more detailed service information from devices' description in XML format. The description may include product name, model name, serial number, vendor ID, and embedded services...etc.
- **Control:** Devices can be manipulated by control points through Control message.

- **Eventing:** Devices can send event message to notify control points if there is any update on services provided.
- **Presentation:** Each device can provide their own control interface by URL link. So that users can go to the device's presentation web page by the URL to control this device.
- **2. Using UPnP in ZyXEL devices**

In this example, we will introduce how to enable UPnP function in ZyXEL devices. Currently, Microsoft MSN is the most popular application exploiting UPnP, so we take Microsoft MSN application as an example in this support note. You can learn how MSN benefit from NAT traversal feature in UPnP in this application note.

In the diagram, suppose PC1 and PC2 both sign in MSN server, and they would like to establish a video conference. PC1 is behind PPPoE dial-up router which supports UPnP. Since the router supports UPnP, we don't need to setup NAT mapping for PC1. As long as we enable UPnP function on the router, PC1 will assign the mapping to the router dynamically. Note that since PC1 must support UPnP, we presume that it's OS is Microsoft WinME or WinXP.

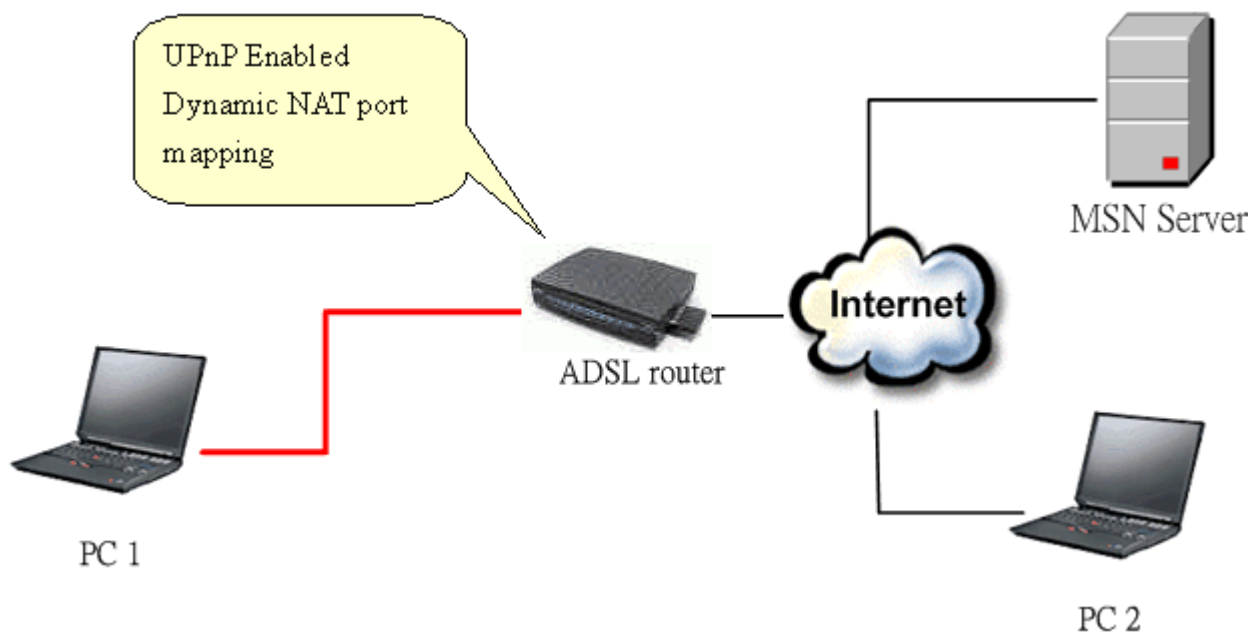

Device: Prestige Router
Service: NAT function provided by Prestige Router
Control Point: PC1

1. Enable UPnP function in ZyXEL device

Go to **Advanced->UPnP**, check two boxes, **Enable UPnP service** and **Allow users to make configuration changes through UPnP**.

The first check box enables UPnP function in this device.

The second check box allow users' application to change configuration in this device. For instance, if you enable this item, then user's MSN application can assign dynamic port mapping to the router. So that network administrator don't need to setup SUA port mapping in the router.

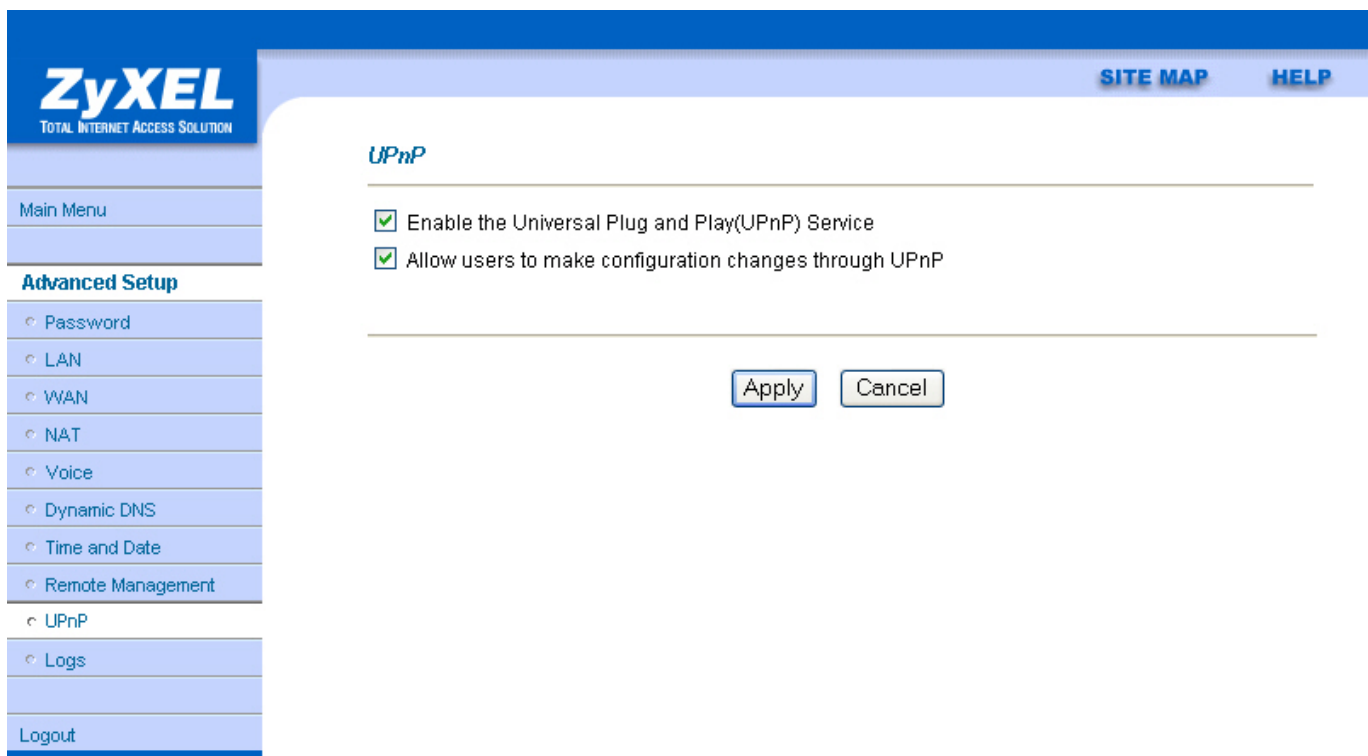

2. After getting IP address, you can go to open MSN application on PC and sign in MSN

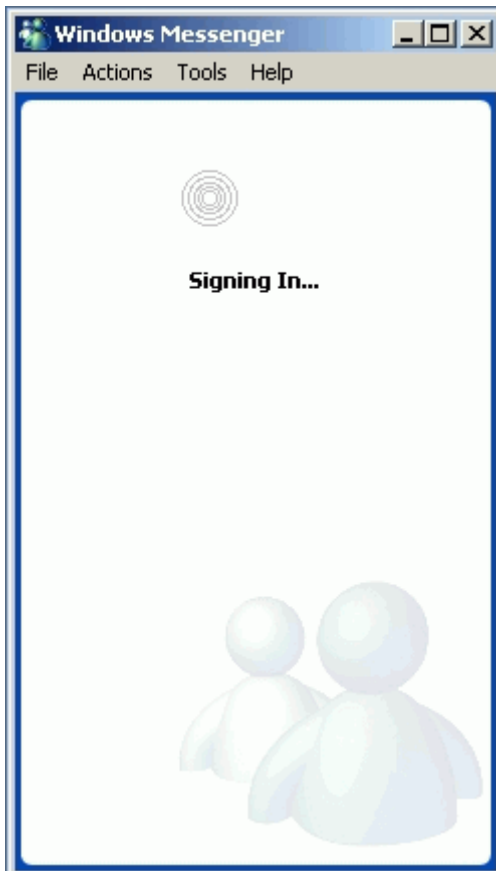

server.

3. Start a Video conversation with one online

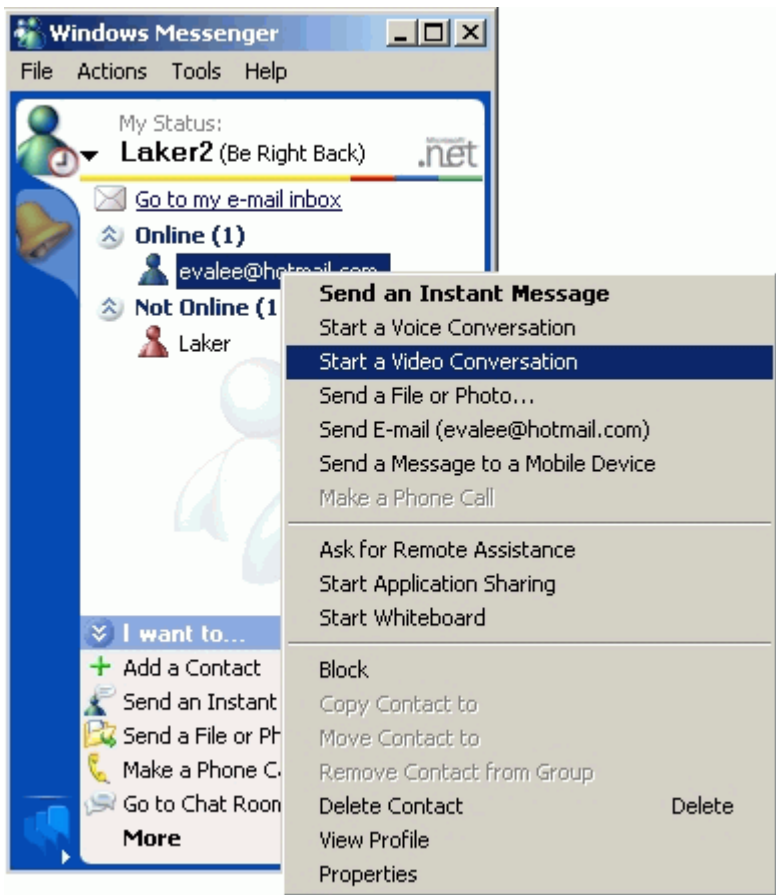

user.

4. On the opposite side, your partner select **Accept** to accept your conversation request.

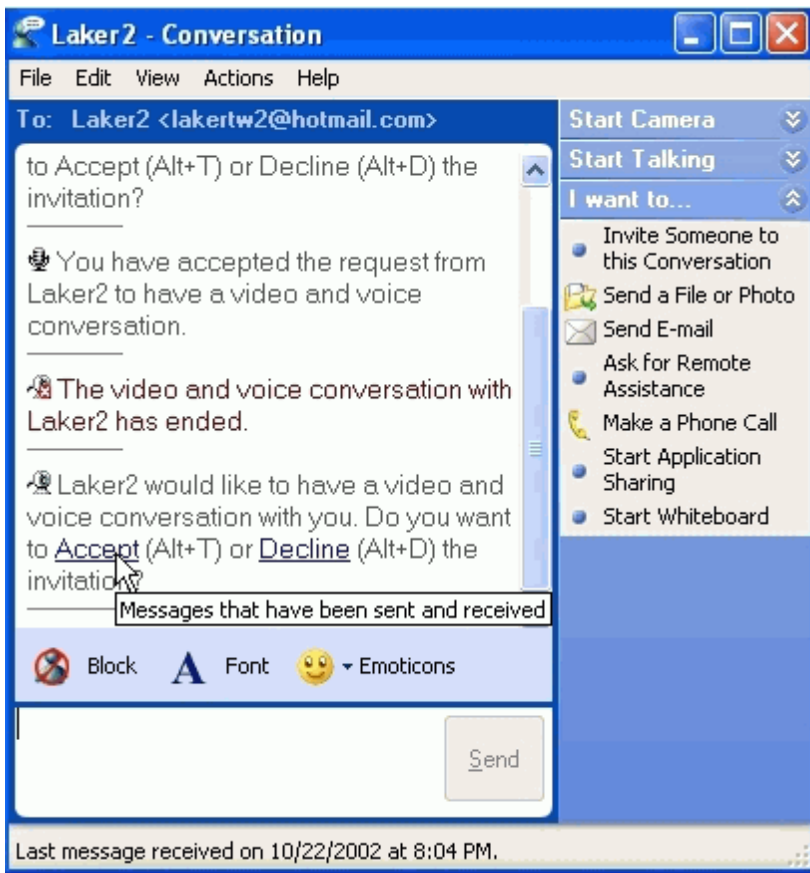

5. Finally, your video conversation is achieved.

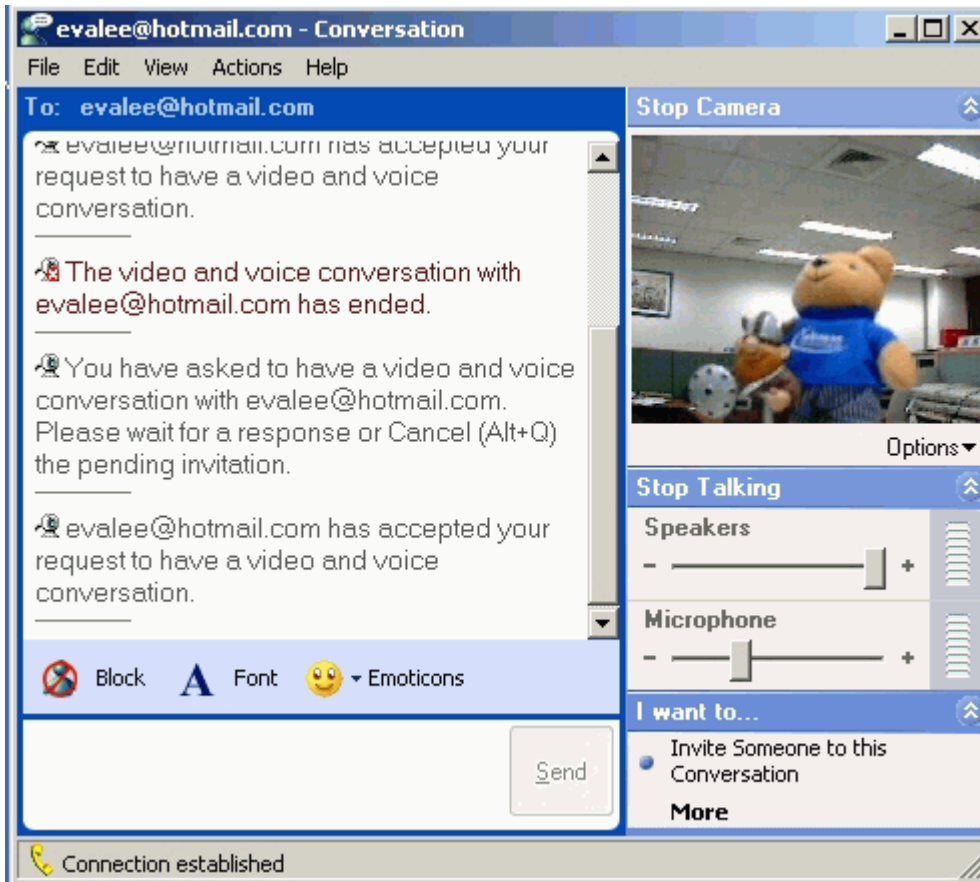

VoIP Application Notes

Setup SIP Account

VoIP is the sending of voice signals over the Internet Protocol. This allows you to make phone calls and send faxes over the Internet at a fraction of the cost of using the traditional circuit-switched telephone network.

The Session Initiation Protocol (SIP) is an application-layer control (signaling) protocol that handles the setting up, altering and tearing down of voice and multimedia sessions over the Internet. SIP signaling is separate from the media for which it handles sessions. The media that is exchanged during the session can use a different path from that of the signaling. SIP handles telephone calls and can interface with traditional circuit-switched telephone networks.

The Prestige can hold up to two SIP account simultaneously please follow the below instruction to configure the SIP account properly.

Note: You should have a voice account already set up and have VoIP information from your VoIP service provider prior to configure SIP account on to the unit.

The screenshot shows the 'Voice - SIP Settings' page in a web browser. At the top right, there are links for 'SITE MAP' and 'HELP'. Below the title, there is a dropdown menu for 'SIP Account' set to 'SIP1'. The settings are organized into sections: 'SIP Settings' with fields for Active SIP (checked), SIP Number (ChangeMe), SIP Local Port (5060), SIP Server Address (server.sip.net), SIP Server Port (5060), REGISTER Server Address (server.sip.net), REGISTER Server Port (5060), and SIP Service Domain (server.sip.net); 'Authentication' with fields for User-ID (ChangeMe) and Password (masked); 'Caller ID' with a checked 'Send Caller ID' box; 'Incoming Call apply to' with checked boxes for 'Phone1' and 'Phone2'; and 'Advanced Settings' with a 'Settings' button. At the bottom, there are 'Back', 'Apply', and 'Cancel' buttons.

With the account information your ITSP provider provided now you may start.

Step 1. Open the web browser from your workstation to connect to the Prestige by entering the Management IP address of the Prestige (LAN IP address). The default management IP of Prestige is 192.168.1.1.

Step 2. Enter the administrator password appear on the page of login and click on login. The default is '1234'

Step 3. On the left column click on **Voice** to bring you to Voice configuration menu than click on **SIP Settings**. While in the **SIP Settings** page use the account selector on upper right of the page to select the SIP account you will like to configure.

Step 4. Check active sip box if you like to use this account and fill in the account information the ITSP provided you in the **SIP setting** category. Which will normally include you **SIP number, SIP local port, SIP server address, SIP server port, Register server port, Register server address, SIP service domain**.

Step 5. In the **Authentication** category fill in the User ID and authentication password your ITSP provided to you.

Step 6. If you wish to send caller ID check the check box in the Caller ID category, if you do not wish to send out caller ID leave the check box uncheck.

Step 7. Check phone port 1 or phone port 2 you will like to associate this account to for incoming call. Prestige allows you to associate either one or both phone port to single SIP account. So you can designate which phone to ring or both to ring when a call is received on specific SIP account.

Step 8. Click on **Apply** to save the setting and take effect. If you would like to configure the 2nd SIP account, please select SIP2 by using the SIP account selector than follow step 1 to 8 to complete the 2nd account setup.

Note: If more than both SIP number are associated both phone port you will not be able to identify which account is being called for the incoming call.

Each field's detail description on this page is listed below.

Label	Description
SIP Account	You can configure the Prestige to use multiple SIP accounts. Select one to configure its settings on the Prestige.
SIP Number	<p>A SIP account's Uniform Resource Identifier (URI) identifies the SIP account in a way similar to the way an e-mail address identifies an e-mail account. It is also known as a SIP identity or address. The format of a SIP identity is SIP-Number@SIP-Service-Domain.</p> <p>A SIP number is the part of the SIP URI that comes before the "@" symbol. Enter your SIP number in this field. You can use up to 31 ASCII characters.</p>

SIP Local Port	Use this field to configure the Prestige’s listening port for SIP. Leave this field set to the default if you were not given a local port number for SIP.
SIP Server Address	Type the IP address of the SIP server in this field.
SIP Server Port	Enter the SIP server’s listening port for SIP in this field. Leave this field set to the default if your VoIP service provider did not give you a local port number for SIP.
REGISTER Server Address	<p>A SIP register server maintains a database of SIP identity-to-IP address (or domain name) mapping. The register server checks your user name and password when you register.</p> <p>Enter the SIP register server’s address in this field.</p> <p>If you were not given a register server address, then enter the address from the SIP Server Address field again here.</p>
REGISTER Server Port	<p>Enter the SIP register server’s listening port for SIP in this field.</p> <p>If you were not given a register server port, then enter the port from the SIP Server Port field again here.</p>
SIP Service Domain	<p>A SIP service domain is the domain name that comes after the @ symbol in a full SIP URI.</p> <p>Enter the SIP service domain name in this field. You can use up to 127 ASCII Extended set characters.</p>
Authentication User ID	This is the user name for registering this SIP account with the SIP register server. Type the user name exactly as it was given to you. Use ASCII characters.
Authentication Password	Type the password associated with the user name above. Use ASCII Extended set characters.
Block Caller ID	Select this check box to not show identification information when you make VoIP calls. Clear this check box to show identification information when you make VoIP calls.
Apply to	Phone 1 and Phone 2 correspond to the Prestige’s physical PHONE 1 and 2 ports, respectively. Select whether you want to receive calls for this

	SIP account on Phone 1 , Phone 2 or both. If you select both, you will not know which SIP account a call is coming in on.
Advanced Settings	Click Settings to open a screen where you can configure the Prestige's advanced VoIP settings like SIP server settings, the RTP port range and the coding type.
Apply	Click Apply to save your changes back to the Prestige.
Reset	Click Reset to begin configuring this screen afresh.

Phone port settings

Prestige allow you to configure the volume and echo cancellation setting for each individual phone port.

Voice - Phone Phone Port Settings: Phone1

Voice Volume Control

Speaking Volume 0

Listening Volume 0

Outgoing Call use

SIP1 SIP2

Echo Cancellation

G.168 Active

Voice Active Detector

VAD Support

Dialing Interval 3

Back Apply Cancel

To configure the phone port setting please follow the below step.

Step 1. Open the web browser from your workstation to connect to the Prestige by entering the Management IP address of the Prestige. The default management IP of Prestige is 192.168.1.1.

Step 2. Enter the administrator password appear on the page of login and click on login. The default is '1234'

Step 3. On the left column click on **Voice** to bring you to voice function menu. While in the Voice menu click on **Phone** to enter phone port configuration page.

Step 4. By using the phone port selector located on upper right of the phone port configuration page select the phone port you wish to configure.

Step 5. Change the phone port parameter as you desired and click **Apply** when you are finish to save and let the setting to take effect. To configure the 2nd phone port use the phone port selector and select phone2 and follow the step 1 to 5 to complete the 2nd phone port setup.

Each field's detail description is listed below.

Label	Description
Phone Port Settings	Use this field to select the phone port that you want to configure.
Speaking Volume	Use this field to set the loudness that the Prestige uses for the speech signal that it sends to the peer device. -1 is the quietest and 1 is the loudest.
Listening Volume	Use this field to set the loudness that the Prestige uses for the speech signal that it receives from the peer device and sends to your phone. -1 is the quietest and 1 is the loudest.
Outgoing Call use	SIP 1 and SIP 2 correspond to the Prestige's SIP accounts. Select whether you want the phone(s) attached to this phone port to use SIP account 1, 2 or both when you make a call. If you select both SIP accounts, the Prestige will first try to use SIP account 2 and then SIP account 1 when you make a call.
G.168 Active	Select this check box to cancel the echo caused by the sound of your voice reverberating in the telephone receiver while you talk.
VAD Support	Select this check box to use Voice Activity Detection (VAD) to reduce the bandwidth that a call uses. The Prestige will generate and send comfort noise when you are not talking.

Dialing Interval	When you are dialing a telephone number the Prestige waits this long after you stop pressing the buttons before initiating the call. Select how many seconds you want the Prestige to wait after the last input on the telephone's keypad before dialing (making) a call.
Apply	Click Apply to save your changes back to the Prestige.
Reset	Click Reset to begin configuring this screen afresh.

Phone book Speed dial

Prestige allows you to configure up to 10 SIP numbers in the phone book for speed dial.

[SITE MAP](#) [HELP](#)

Voice - Speed Dial

Add New Entry

Speed Dial	SIP Number	Name	Type	
#01 <input type="button" value="v"/>	<input type="text" value="test"/>	<input type="text" value="zyxel"/>	<input checked="" type="radio"/> Use Proxy <input type="radio"/> Non-Proxy (Use IP or URL)	<input type="button" value="Add"/>

Speed Dial Phone Book

Speed Dial	SIP Number	Name	Destination	
#01	test	zyxel		<input type="button" value="Delete"/> <input type="button" value="Edit"/>
#02				<input type="button" value="Delete"/> <input type="button" value="Edit"/>
#03				<input type="button" value="Delete"/> <input type="button" value="Edit"/>
#04				<input type="button" value="Delete"/> <input type="button" value="Edit"/>

To configure phone book for speed dial please follow the below step.

Step 1. Open the web browser from your workstation to connect to the Prestige by entering the Management IP address of the Prestige. The default management IP of Prestige is 192.168.1.1.

Step 2. Enter the administrator password appear on the page of login and click on login. The default is '1234'

Step 3. On the left column click on **Speed Dial** to bring you to **Speed Dial** page to enter speed dial configuration page.

Step 4. Select the entry number you wish to add to the phone book by the entry selector located under add new entry category on the speed dial field.

Step 5. Fill in the SIP number of the remote party and a descriptive name and click on the radio button to select either to use proxy or entering static IP or URL remote peer.

Step 6. Click on Add button when you are finish to add the entry to the phone book.

Each field's detail description of the page is listed below.

Label	Description
Add New Entry	Use this section of the screen to edit and save new or existing speed dial phone book entries.
Speed Dial	Select a speed dial key combination from the drop-down list box.
SIP Number	Enter the SIP number of the party that you will call (use the number or text that comes before the @ symbol in a full SIP URI). You can use up to 127 ASCII characters.
Name	Enter a descriptive name to identify the party that you will use this entry to call. You can use up to 127 ASCII characters.
Type	Select Use Proxy if calls to this party use your SIP account configured in the VoIP screen. Select Non-Proxy (Use IP or URL) if calls to this party use a different SIP server or go directly to the callee's VoIP phone (IP-to-IP). Enter the SIP server's or the party's IP address or domain name (up to 127 ASCII Extended set characters).
Add	Click this button to save the entry in the speed dial phone book. The speed dial entry displays in the Speed Dial Phone Book section of the screen.
Speed Dial Phone Book	This section of the screen displays the currently saved speed dial entries. You can configure up to 10 entries and use them to make calls.

Speed Dial	This is the entry's speed dial key combination. Press this key combination on a telephone attached to the Prestige in order to call the party named in this entry.
Name	This is the descriptive name of the party that you will use this speed dial entry to call.
SIP Number	This is the SIP number of the party that you will call.
Type	This field displays Use Proxy if calls to this party use one of your SIP accounts. This field displays the SIP server's or the party's IP address or domain name if calls to this party do not use one of your SIP accounts.
Delete	Click this button to remove an entry from the speed dial phonebook.
Edit	Click this button to change the speed dial entry. The speed dial entry displays in the Add New Entry section of the screen where you can edit it.
Clear	Click this button to remove all of the entries from the speed dial phonebook.

FAQ

ZyNOS FAQ

What is ZyNOS?

ZyNOS is ZyXEL's proprietary Network Operating System. It is the platform on all Prestige routers that delivers network services and applications. It is designed in a modular fashion so it is easy for developers to add new features. New ZyNOS software upgrades can be easily downloaded from our FTP sites and public Web download site as they become available.

How do I access the embedded web configurator?

The Web configurator a user friendly configuration interface via user's web browser, which can be access by typing in the LAN IP address of the Prestige in users web browser. To access the Prestige's web configurator via web browser, the configuration PC must be in the same IP segment of Prestige and Prestige must be reachable to the configuration station. (By default the Prestige LAN IP is 192.168.1.1)

What is the default LAN IP address and Password? Moreover, how do I change it?

The default LAN IP address is "192.168.1.1" and you can change the LAN IP in web configuration menu under "LAN" -> LAN TCP/IP, the default password is 1234. You can change the password once you enter the web configuration menu under "SYSTEM" and press the Password tab. At the password screen type in the old password and the new password and retype to confirm than press "Apply" button to save the change.

How do I upload the ZyNOS firmware code via embeded web configurator?

The procedure for uploading ZyNOS via embeded web configurator is as follows.

- a. Log on into the web configurator.
- b. Press "MAINTENANCE" from the left menu.
- c. Press "F/W Upload" tab.
- d. Press "browse" button and point to the directory where the firmware you want to upload is kept and press "Upload" button.
- e. It will prompt you the firmware is upload successful and Prestige will reboot.

How do I upgrade/backup the ZyNOS firmware by using FTP client program via LAN?

The Prestige allows you to transfer the firmware from/to Prestige by using FTP program via LAN. The procedure for uploading ZyNOS via FTP is as follows.

- a. To upgrade firmware, use FTP client program to put firmware in file 'ras' in the Prestige. After data transfer is finished, the Prestige will program the upgraded firmware into FLASH ROM and reboot itself. Note: Do not power off the unit after upload the file via ftp until the system LED have become steady light up. Fail to due so may result in update fail and require RMA.
- b. To backup your firmware, use the FTP client program to get file 'ras' from the Prestige.

How do I upload or backup ROMFILE via web configurator?

In some situations, you may need to upload the ROMFILE, restore to previous saved configuration, or the need of resetting SMT to factory default.

The procedure for uploading ROMFILE via the web configurator is as follows.

- a. Log on into the web configurator.
- b. Press "MAINTENANCE" from the left menu.
- c. Press "Configuration" tab.
- d. Press "Restore" tab and press browse button point to the directory where the romfile you want to upload is stored.
- e. Press "Upload" button.

The procedure for backup ROMFILE via the web configurator is as follow

- a. Log on into the web configurator.
- b. Press "MAINTENANCE" from the left menu.
- c. Press "Configuration" tab.
- d. Press "Backup" button, a pop up windows will ask you where to store the back up romfile.
- e. Press "Save file" and browse to where you want the file be save.
- f. Press "Save" button.

How do I backup/restore configurations by using FTP client program via LAN?

- a. Use the a FTP client program in your PC (such as cuteftp, wsftp client) to login to your Prestige.
- b. To backup the configurations, use FTP client program to get file 'rom-0' from the Prestige.
- c. To restore the configurations, use the FTP client program to put your configuration in file ROM-0 in the Prestige.

Why can't I make Telnet to Prestige from WAN?

There are three possible reasons that Telnet from WAN is blocked.

- a. You have not enable Telnet service on WAN interface in Menu 24.11.
- b. Telnet service is enabled but your host IP is not the secured host entered in Menu 24.11. In this case, the error message 'Client IP is not allowed!' will appear on the Telnet screen.

- c. The default filter rule 3 (Telnet_FTP_WAN) is applied in the Input Protocol field in menu 11.5.

What should I do if I forget the system password?

In case you forget the system password. You can reset the unit back to factory default. You can reset the unit by using a sharp pointed object such as a pen and press and hold down the “reset” button for 5 second or until the power LED starts to blink than release. The unit is than reset back to factory default. The reset button is located near by the power jack on the unit back panel.

Note: By reset the unit back to factory default you will lost all your previous settings.

What is SUA? When should I use SUA?

SUA (Single User Account) is a unique feature supported by Prestige router which allows multiple people to access Internet concurrently for the cost of a single user account.

When Prestige acting as SUA receives a packet from a local client destined for the outside Internet, it replaces the source address in the IP packet header with its own address and the source port in the TCP or UDP header with another value chosen out of a local pool. It then recomputed the appropriate header checksums and forwards the packet to the Internet as if it is originated from Prestige using the IP address assigned by ISP. When reply packets from the external Internet are received by Prestige, the original IP source address and TCP/UDP source port numbers are written into the destination fields of the packet (since it is now moving in the opposite direction), the checksums are recomputed, and the packet is delivered to its true destination. This is because SUA keeps a table of the IP addresses and port numbers of the local systems currently using it.

What is the difference between NAT and SUA?

NAT is a generic name defined in RFC 1631 'The IP Network Address Translator (NAT)'. SUA (Internet Single User Account) is ZyXEL's implementation and trade name for functioning PAT which is a specific type of NAT. SUA (or PAT for NAT) translates address into port mapping.

The primary motivation for RFC 1631 is that there is not enough IP address to go around. In addition, many corporations simply did not bother to obtain legal (globally unique) IP addresses for their networks and now finding themselves unable to connect to the Internet.

Basically, NAT is a process of translating one address to another. A NAT implementation can be as simple as substituting an IP address with another. This allows a network to rectify the illegal address problem mentioned above without going through each and every host.

The design goal of ZyXEL's SUA is to minimize the Internet access cost in a small office environment by using a single IP address to represent the multiple hosts inside. It does more than IP address translation, so that multiple hosts on the LAN can access the Internet at the same time.

How many network users can the SUA/NAT support?

The Prestige does not limit the number of the users but the number of the sessions. The Prestige supports 1024 sessions that you can use the 'ip nat iface enif0 disp' command in menu 24.8 to view the current active sessions.

What are Device filters and Protocol filters?

In ZyNOS, the filters have been separated into two groups. One group is called 'device filter group', and the other is called 'protocol filter group'. Generic filters belong to the 'device filter group', TCP/IP and IPX filters belong to the 'protocol filter group'.

Why can't I configure device filters or protocol filters?

In ZyNOS, you can not mix different filter groups in the same filter set.

Product FAQ

What is the Prestige Integrated Access Device?

The Prestige series fulfills a range of application environments, from small and medium businesses, SOHO, or Telecommuters, to home user or education applications. Prestige's design helps users to save expenses, minimize maintenance, and simultaneously provide a high quality networking environment.

The Prestige series is a robust solution complete with everything needed for providing Internet access to multiple workstations through ADSL. The IAD is equipped with 1 auto-MDI/MDIX 10/100Mbps Ethernet LAN port, 1 ADSL WAN port. It is the most simple and affordable solution for multiple and instant broadband Internet access router.

Virtually all-popular applications over Internet, such as Web, E-Mail, FTP, Telnet, Gopher, are supported. Prestige is designed for SOHO, branch offices, workgroups, and educational users.

Will the Prestige work with my Internet connection?

The Prestige is designed to be compatible major ISP utilize ADSL as a broadband service. Prestige IAD offers an Ethernet port to connect to your computer so the Prestige is placed in the line between the computer and your ISP. If your ISP supports PPPoE/PPPoA you can also use the Prestige, because PPPoE/PPPoA had been supported in the Prestige.

What do I need to use the Prestige?

You need an ADSL modem/router to use with ADSL line, Prestige is an idea device for such application. The Prestige has one Ethernet ports: LAN port and one ADSL WAN port. You should connect the computer to the LAN port and connect the ADSL line to the WAN port. If the ISP uses PPPoE or PPPoA you need the user account to enter in the Prestige.

What is PPPoE?

PPPoE stands for **P**oint-to-**P**oint **P**rotocol **o**ver **E**thernet that is an IETF draft standard specifying how a computer interacts with a broadband modem (i.e. xDSL, cable, wireless, etc.) to achieve access to the high-speed data networks via a familiar PPP dialer such as 'Dial-Up Networking' user interface. PPPoE supports a broad range of existing applications and service including authentication, accounting, secure access and configuration management. There are some service providers running of PPPoE today. Before configuring PPPoE in the Prestige, please make sure your ISP supports PPPoE.

Does the Prestige support PPPoE?

Yes. The Prestige supports PPPoE since ZyNOS 2.50.

How do I know I am using PPPoE?

PPPoE requires a user account to login to the provider's server. If you need to configure a user name and password on your computer to connect to the ISP you are probably using PPPoE. If you are simply connected to the Internet when you turn on your computer, you probably are not. You can also check your ISP or the information sheet given by the ISP. Please choose PPPoE as the encapsulation type in the Prestige if the ISP uses PPPoE.

Why does my provider use PPPoE?

PPPoE emulates a familiar Dial-Up connection. It allows your ISP to provide services using their existing network configuration over the broadband connections. Besides, PPPoE supports a broad range of existing applications and service including authentication, accounting, secure access and configuration management.

Which Internet Applications can I use with the Prestige?

Most common applications include MIRC, PPTP, ICQ, Cu-SeeMe, NetMeeting, IP/TV, RealPlayer, VDOLive, Quake, QuakeII, QuakeIII, StarCraft, & Quick Time.

How can I configure the Prestige?

- a. Telnet remote management- Menu driven user interface for easy remote management
- b. Web browser- web server embedded for easy configurations

What network interface does the Prestige support?

The Prestige supports 10/100M Ethernet to connect to the LAN computer or hub/switch and 10/100M ADSL interface to the ISP.

What can we do with Prestige?

Browse the World Wide Web (WWW), send and receive individual e-mail, and download software. These are just a few of many benefits you can enjoy when you put the whole office on-line with the Prestige Internet Access Sharing Router.

Does Prestige support dynamic IP addressing?

The Prestige supports either a static or dynamic IP address from ISP.

What is the difference between the internal IP and the real IP from my ISP?

Internal IPs is sometimes referred to as virtual IPs. They are a group of up to 255 IPs that are used and recognized internally on the local area network. They are not intended to be recognized on the Internet. The real IP from ISP, instead, can be recognized or pinged by another real IP. The Prestige Internet Access Sharing Router works like an intelligent router that route between the virtual IP and the real IP.

How does e-mail work through the Prestige?

It depends on what kind of IP you have: Static or Dynamic. If your company has a domain name, it means that you have a static IP address. Suppose your company's e-mail address is xxx@mycompany.com. Joe and Debbie will be able to send e-mail through Prestige Internet Access Device using jane@mycompany.com and debbie@mycompany.com respectively as their e-mail addresses. They will be able to retrieve their individual private and secure e-mail, if they have been assigned the proper access right.

If your company does not have a domain name, it means that your ISP provides you with a dynamic IP address.

Suppose your company's e-mail address is mycompany@ispname.com. Jane and John will be able to send e-mail through Prestige Internet Access Sharing Router using "jane"<mycompany@ispname.com> and "john"<mycompany@ispname.com> respectively as their e-mail addresses. Again, they will be able to retrieve their individual private and secured e-mail, if they have been assigned the proper access right.

Is it possible to access a server running behind SUA from the outside Internet? If possible, how?

Yes, it is possible because Prestige delivers the packet to the local server by looking up to a SUA server table. Therefore, to make a local server accessible to the outside users, the port number and the inside IP address of the server must be configured in Menu 15 - [SUA Server Setup](#).

What DHCP capability does the Prestige support?

The Prestige supports DHCP client (Ethernet encap) on the WAN port and DHCP server on the LAN port. The Prestige's DHCP client allows it to get the Internet IP address from ISP automatically if your ISP use DHCP as a method to assign IP address. The Prestige's internal DHCP server allows it to automatically assign IP and DNS addresses to the clients on the local LAN.

How do I used the reset button, more over what field of parameter will be reset by reset button?

You can used a sharp pointed object insert it into the little reset hole beside the power connector. Press down the reset button and hold down for approx 5 second, the unit will be reset. When the reset button is pressed the devices all parameter will be reset back to factory default include, password, and IP address.

The default IP address is 192.168.1.1, Password 1234.

What network interface does the new Prestige series support?

The new Prestige series support auto MDX/MDIX 10/100M Ethernet LAN port to connect to the computer or Switch on LAN and ADSL port on WAN.

How does the Prestige support TFTP?

In addition to the direct console port connection, the Prestige supports the uploading/download of the firmware and configuration file using TFTP (Trivial File Transfer Protocol) over LAN.

Can the Prestige support TFTP over WAN?

Although TFTP should work over WAN as well, it is not recommended because of the potential data corruption problems.

How fast can the data go?

The speed of the ADSL is only one part of the equation. There are a combination of factors starting with how fast your PC can handle IP traffic, then how fast your PC to cable modem interface is, then how fast the cable modem system runs and how much congestion there is on the cable network, then how big a pipe there is at the head end to the rest of the Internet.

Different models of PCs and Macs are able to handle IP traffic at varying speeds. Very few can handle it at 30 Mbps.

Ethernet (10baseT) is the most popular cable modem interface standard for the PC. This automatically limits the speed of the connection to under 10 Mbps even if the cable modem can receive at 30 Mbps. Most Local Area Networks use 10baseT Ethernet, and although they are 10 Mbps networks, it takes a LOT longer than one second to transmit 10 megabits (or 1.25 megabytes) of data from one terminal to another.

Cable modems on the same node share bandwidth, which means that congestion is created when too many people are on simultaneously. One user downloading large graphic or video files can use a significant portion of shared bandwidth, slowing down access for other users in the same neighborhood.

Most independent Internet Service Providers today connect to the Internet using a single 1.5 Mbps "T1" telephone line. All of their subscribers share that 1.5 Mbps pipeline. Cable head-ends connecting to the Internet backbone using a T1 limit their subscribers to an absolute maximum of 1.5 Mbps.

To create the appearance of faster network access, service companies plan to store or "cache" frequently requested web sites and Usenet newsgroups on a server at their head-end. Storing data locally will remove some of the bottleneck at the backbone connection.

How fast can they go? In a perfect world (or lab) they can receive data at speeds up to 30 Mbps. In the real world, with cost conscious cable companies running the systems, the speed will probably fall to about 1.5 Mbps.

What is Multi-NAT?

NAT (Network Address Translation-NAT RFC 1631) is the translation of an Internet Protocol address used within one network to a different IP address known within another network. One network is designated the *inside* network and the other is the *outside*. Typically, a company maps its local inside network addresses to one or more global outside IP addresses and "unmaps" the global IP addresses on incoming packets back into local IP addresses. The IP addresses for the NAT can be either fixed or dynamically assigned by the ISP. In addition, you can designate servers, e.g., a web server and a telnet server, on your local network and make them accessible to the outside world. If you do not define any servers, NAT offers the additional benefit of firewall protection. In such case, all incoming connections to your network will be filtered out by the Prestige, thus preventing intruders from probing your network.

The SUA feature that the Prestige supports previously operates by mapping the private IP addresses to a global IP address. It is only one subset of the NAT. The Prestige with ZyNOS V3.00 supports the most of the features of the NAT based on RFC 1631, and we call this feature as '**Multi-NAT**'. For more information on IP address translation, please refer to RFC 1631, *The IP Network Address Translator (NAT)*.

When do I need Multi-NAT?

- a. **Make local server accessible from outside Internet**

When NAT is enabled the local computers are not accessible from outside. You can use Multi-NAT to make an internal server accessible from outside.

- a. **Support Non-NAT Friendly Applications**

Some servers providing Internet applications such as some mIRC servers do not allow users to login using the same IP address. Thus, users on the same network can not login to the same server simultaneously. In this case it is better to use Many-to-Many No Overload or One-to-One NAT mapping types, thus each user login to the server using a unique global IP address.

What IP/Port mapping does Multi-NAT support?

NAT supports five types of IP/port mapping. They are: One to One, Many to One, Many to Many Overload, Many to Many No Overload and Server. The details of the mapping between ILA and IGA are described as below. Here we define the local IP addresses as the Internal Local Addresses (ILA) and the global IP addresses as the Inside Global Address (IGA),

1. One to One

In One-to-One mode, the Prestige maps one ILA to one IGA.

2. Many to One

In Many-to-One mode, the Prestige maps multiple ILA to one IGA. This is equivalent to SUA (i.e., PAT, port address translation), ZyXEL's Single User Account feature that previous ZyNOS routers supported (the SUA only option in today's routers).

3. Many to Many Overload

In Many-to-Many Overload mode, the Prestige maps the multiple ILA to shared IGA.

4. Many to Many No Overload

In Many-to-Many No Overload mode, the Prestige maps each ILA to unique IGA.

5. Server

In Server mode, the Prestige maps multiple inside servers to one global IP address. This allows us to specify multiple servers of different types behind the NAT for outside access. Note, if you want to map each server to one unique IGA please use the One-to-One mode.

The following table summarizes these types.

NAT Type	IP Mapping
One-to-One	ILA1<--->IGA1
Many-to-One (SUA/PAT)	ILA1<--->IGA1 ILA2<--->IGA1 ...
Many-to-Many	ILA1<--->IGA1

Overload	ILA2<--->IGA2 ILA3<--->IGA1 ILA4<--->IGA2 ...
Many-to-Many No Overload	ILA1<--->IGA1 ILA2<--->IGA2 ILA3<--->IGA3 ILA4<--->IGA4 ...
Server	Server 1 IP<--->IGA1 Server 2 IP<--->IGA1

What is the difference between SUA and Multi-NAT?

SUA (Single User Account) in previous ZyNOS versions is a NAT set with 2 rules, Many-to-One and Server. The Prestige now has **Full Feature** NAT support to map global IP addresses to local IP addresses of clients or servers. With multiple global IP addresses, multiple servers of the same type (e.g., FTP servers) are allowed on the LAN for outside access. In previous ZyNOS versions that supported SUA 'visible' servers had to be of different types. The Prestige supports NAT sets on a remote node basis. They are reusable, but only one set is allowed for each remote node. The Prestige supports 2 sets since there is only one remote node. The default SUA (Read Only) Set in menu 15.1 is a convenient, pre-configured, read only, Many-to-One mapping set, sufficient for most purposes and helpful to people already familiar with SUA in previous ZyNOS versions.

What is BOOTP/DHCP?

BOOTP stands for Bootstrap Protocol. DHCP stands for Dynamic Host Configuration Protocol. Both are mechanisms to dynamically assign an IP address for a TCP/IP client by the server. In this case, the Prestige Internet Access Sharing Router is a BOOTP/DHCP server. Win95 and WinNT clients use DHCP to request an internal IP address, while WFW and WinSock clients use BOOTP. TCP/IP clients may specify their own IP or utilize BOOTP/DHCP to request an IP address.

What is DDNS?

The Dynamic DNS service allows you to alias a dynamic IP address to a static hostname, allowing your computer to be more easily accessed from various locations on the Internet. To use the service, you must first apply an account from several free Web servers such as WWW.DYNDNS.ORG.

Without DDNS, we always tell the users to use the WAN IP of the 312 to reach our internal server. It is inconvenient for the users if this IP is dynamic. With DDNS supported by the Prestige, you apply a DNS name

(e.g., www.zyxel.com.tw) for your server (e.g., Web server) from a DDNS server. The outside users can always access the web server using the www.zyxel.com.tw regardless of the WAN IP of the 312.

When the ISP assigns the Prestige a new IP, the Prestige updates this IP to DDNS server so that the server can update its IP-to-DNS entry. Once the IP-to-DNS table in the DDNS server is updated, the DNS name for your web server (i.e., www.zyxel.com.tw) is still usable.

When do I need DDNS service?

When you want your internal server to be accessed by using DNS name rather than using the dynamic IP address we can use the DDNS service. The DDNS server allows to alias a dynamic IP address to a static hostname. Whenever the ISP assigns you a new IP, the Prestige sends this IP to the DDNS server for its updates.

What DDNS servers does the Prestige support?

The DDNS servers the Prestige supports currently is WWW.DYNDNS.ORG where you apply the DNS from and update the WAN IP to.

What is DDNS wildcard?

Some DDNS servers support the wildcard feature which allows the hostname, *.yourhost.dyndns.org, to be aliased to the same IP address as yourhost.dyndns.org. This feature is useful when there are multiple servers inside and you want users to be able to use things such as www.yourhost.dyndns.org and still reach your hostname.

Does the Prestige support DDNS wildcard?

Yes, the Prestige supports DDNS wildcard that WWW.DynDNS.ORG supports. When using wildcard, you simply enter yourhost.dyndns.org in the **Host** field in Menu 1.1.

Can the Prestige SUA handle IPsec packets sent by the VPN gateway behind Prestige?

Yes, the Prestige's SUA can handle IPsec ESP Tunneling mode. We know when packets go through SUA, SUA will change the source IP address and source port for the host. To pass IPsec packets, SUA must understand the ESP packet with protocol number 50, replace the source IP address of the IPsec gateway to the router's WAN IP address. However, SUA should not change the source port of the UDP packets which are used for key managements. Because the remote gateway checks this source port during connections, the port thus is not allowed to be changed.

How do I setup my Prestige for routing IPsec packets over SUA?

For outgoing IPsec tunnels, no extra setting is required. For forwarding the inbound IPsec ESP tunnel, A 'Default' server set in menu 15 is required. It is because SUA makes your LAN appear as a single machine to the outside world. LAN users are invisible to outside users. So, to make an internal server for outside access, we must specify the service port and the LAN IP of this server in Menu 15. Thus SUA is able to forward the incoming packets to the requested service behind SUA and the outside users access the server using the Prestige's WAN IP address. So, we have to configure the internal IPsec as a default server (unspecified service port) in menu 15 when it acts a server gateway.

VoIP FAQ

What is Voice over IP?

Voice over IP is an emerging technology based on open standards of IEEE, fundamentally the Internet Protocol, that allows voice data to travel across the Internet. There are many method to used this technology, the most common and well known are SIP, and H.323.

How does Voice over IP work?

Basically VoIP is a technic to send voice information in digital form in discrete packets over digital network rather than by using traditional circuit switch (PSTN). To do so we will need an analog to digital converter on sender side to translate the voice (analog signal) to digital than transmit it, and on the receiver end it will also need an analog to digital converter to covert the digital signal back to analog to the person being called can heard the voice.

Why use VoIP?

Traditionally telephony carrier use circuit switching for carrying voice traffic. As circuit switching is designed to carry voice and it does it very well. Than why use IP for voice? As broadband booms, and technology evolve. People now want to communicate through various way not just voice such as email, instant messaging, video and so on. Traditional telephony can not evolve as quickly as the demand and develop new feature on circuit switch takes much time and money. IP is an already exist standard and many type of service already runs on IP, by using IP as a platform integrate service is now possible and low cost where traditional circuit may take long time to achieve.

What is the relationship between codec and VoIP?

In order to transfer voice (analog signal) over IP it first need to be digitized. Codec is a technic to digitize analog signal to digital and vice versa. There are various speech codec available and can be used with VoIP each with it's advantage and disadvantage.

What advantage does Voice over IP can provide?

The advantage of VoIP is it can provide advance services such as joining e-mail, instant messaging, video, voice mail all together. Where current circuit switching (PSTN) can not.

What is the difference between H.323 and SIP?

H.323 and SIP are proposed by different group Session Initiation Protocol (SIP) is a standard introduced by the Internet Engineering Task Force in 1999 to carry voice over IP. Since it was created by the IETF, it approaches voice and multimedia from the Internet, or IP, perspective of view. Where as H.323 emerged around 1996, and as an International Telecommunication Union standard it was designed from a telecommunications perspective. Both standards have the same objective - to enable voice and multimedia convergence with IP protocols.

Can H.323 and SIP interoperate with one another?

In interoperability between the two, the industry is making slow but sure progress. Interoperability must first happen between vendor implementations of the same protocol (SIP-to-SIP and H.323-to-H.323) and then between protocols. Currently in order for SIP client to talk to H.323 client the ITSP must have a trunking gateway act as a translator between the two protocols without the trunking gateway the two protocols are not able to communicate to one another.

What is voice quality?

Voice quality is how well an person can hear the voice on the opposite end.

How are voice quality normally rated?

Voice quality is most commonly rated through a voice quality metric called the Mean Opinion Score (MOS) which is recommendation by ITU-T. The MOS is a 5 point scale where 5 represent excellent voice quality and 1 represent bad voice quality.

What is codec?

Codec is a algorithm which converts analog signal into digital signal and vice versa. There are three main type of waveform codec, source codec, and hybrid codec. Each consume different amount of bandwidth and provide different voice quality level.

What is the relation of codec and VoIP?

As VoIP is a general term send voice information in digital form in discrete packets over digital network and this digital network is public network, thus there maybe other packet such data packet uses network at the same time. The codec choose is related to how much bandwidth voice packet will consume. In bandwidthwise aspect the smaller amount of bandwidth used the better. But in voice aspect the higher quality the better.

What codec does Prestige support?

Prestige supports the following commonly used codec.

- G.729 voice codec
- G.711u-law voice codec
- G.711a-law voice codec

Note: G.711 u-law or G.711 a-law is country specific, thus ZyXEL device is shipped preconfigured to use u-law or a-law according to specific country. If for special reason this setting needed to be changed. It can be modify through device CI command through telnet. For the command please refer to the CI command list in the firmware release note.

Which codec should I choose?

As which codec choose is depending on what codec is supported on both end of the VoIP host. Generally a codec with low bandwidth consumption and high voice quality is a good codec .

What do I need in order to use SIP?

The minimum required to use VoIP is as follow.

1. A high-speed Internet connection. This can be a cable modem, or a high-speed network services such as ISDN, DSL or a T-1 link. The need of the bandwidth required will depend on the amount of telephone traffic will be in your network.

2. A PC with VoIP software installed or a hardware VoIP box such as ATA or device like Prestige 2602 VoIP station router.
3. An account with a VoIP provider such as an ITSP. The account can be configured to recognize your calls automatically, or you can require the users to enter their unique account numbers issued.

Unable to register with the SIP server?

If you are unable to register with SIP server.

1. Make sure the Internet is reachable and the SIP register server is reachable. If your register server uses domain name make sure DNS name can be resolved. If you are using static WAN IP make sure DNS server is configured correctly on your Prestige.
2. Make sure the SIP account is correct and the password is key in correctly.
3. Check if there is NAT router before it. Prestige is a VoIP station gateway. We do not suggest to have an NAT router before it as it may cause many unexpected problem. If you have an NAT router before it we suggest to use a VoIP ATA (VoIP Analog Telephone Adapter) such as Prestige ATA series.

I can register but can not establish a call?

If you can register to server but can not make a call very likely there is NAT router or firewall before it which is blocking it. We do not suggest to have an NAT router before it as it may cause many unexpected problem. If you have an NAT router before it we suggest to use a VoIP ATA (VoIP Analog Telephone Adapter) such as Prestige ATA series.

If the problem is a firewall before it. Please check with the firewall manager, make sure the SIP protocol is allow to pass-through firewall, and the range of RTP port is allowed through firewall.

I can make a call but the voice only goes one way not bothway?

If you can register to server and I can make a call signal establishment but the voice only goes one way. In this case it is very likely there are NAT router or firewall before it, please see NAT/firewall related question above.

I can receive a call but the voice only goes one way not bothway?

If you can register to server but can only make out going call but can not receive incoming calls or the incoming call signal establishment can be made but voice only goes one way very likely there is NAT/firewall router before it, please see NAT/firewall related question above for tips to troubleshoot.

If all the about have been tried, but register still fail what should I do?

In such case, please contact your local vendor for support. If they can't help out the problem they will escalate your problem to ZyXEL tech center. To report a problem please prepared below info.

1. Serial number of the device.
2. SIP Call server type and vendor.
3. Your device firmware version and romfile with password.
4. Detail information what you have tried to resolve the problem.

I suspect there is a hardware problem with my Prestige what should I do?

Please follow the troubleshooting section in the user's guide for brief hardware troubleshooting and diagnostic tips. If you are sure there is a hardware problem after following the hardware diagnostic tips in the user's guide. Please contact your ZyXEL local vendor to send the device in for RMA service.

Trouble Shooting

For general device installation or basic trouble shooting please refer to the device user's guide

Using Embedded Packet Trace

[Embedded Packet Trace](#)

The Prestige packet trace records and analyzes packets running on LAN and WAN interfaces. It is designed for users with technical backgrounds who are interested in the details of the packet flow on LAN or WAN end of Prestige. It is also very helpful for diagnostics if you have compatibility problems with your ISP or if you want to know the details of a packet for configuring a filter rule.

The format of the display is as following:

Packet:

```
0 11880.160 ENETO-R[0062] TCP 192.168.1.2:1108->192.31.7.130:80
```

[index] [timer/second][channel-receive/transmit][length] [protocol] [sourceIP/port] [destIP/port]

There are two ways to dump the trace:

1. **Online Trace--display the trace real time on screen**
2. **Offline Trace--capture the trace first and display later**

The details for capturing the trace in SMT menu 24.8 are as follows.

Online Trace

1. Trace LAN packet
 2. Trace WAN packet
-

1. Trace LAN packet

- 1.1 Disable to capture the WAN packet by entering: **sys trcp channel enet1 none**
 - 1.2 Enable to capture the LAN packet by entering: **sys trcp channel enet0 bothway**
 - 1.3 Enable the trace log by entering: **sys trcp sw on & sys trcl sw on**
 - 1.4 Display the brief trace online by entering: **sys trcd brief**
- or
- 1.5 Display the detailed trace online by entering: **sys trcd parse**

Example:

```
Prestige> sys trcp channel enet1 none
Prestige> sys trcp channel enet0 bothway
Prestige> sys trcp sw on
Prestige> sys trcl sw on
Prestige> sys trcd brief
0 11880.160 ENETO-R[0062] TCP 192.168.1.2:1108->192.31.7.130:80
1 11883.100 ENETO-R[0062] TCP 192.168.1.2:1108->192.31.7.130:80
2 11883.330 ENETO-T[0058] TCP 192.31.7.130:80->192.168.1.2:1108
3 11883.340 ENETO-R[0060] TCP 192.168.1.2:1108->192.31.7.130:80
```

```
4 11883.340 ENETO-R[0339] TCP 192.168.1.2:1108->192.31.7.130:80
5 11883.610 ENETO-T[0054] TCP 192.31.7.130:80->192.168.1.2:1108
6 11883.620 ENETO-T[0102] TCP 192.31.7.130:80->192.168.1.2:1108
7 11883.630 ENETO-T[0054] TCP 192.31.7.130:80->192.168.1.2:1108
8 11883.630 ENETO-R[0060] TCP 192.168.1.2:1108->192.31.7.130:80
9 11883.650 ENETO-R[0060] TCP 192.168.1.2:1108->192.31.7.130:80
10 11883.650 ENETO-R[0062] TCP 192.168.1.2:1109->192.31.7.130:80
```

```
Prestige> sys trcd parse
```

```
---<0000>-----
```

```
LAN Frame: ENETO-RECV Size: 62/ 62 Time: 12089.790 sec
```

```
Frame Type: TCP 192.168.1.2:1116->192.31.7.130:80
```

Ethernet Header:

```
Destination MAC Addr = 00A0C5921311
Source MAC Addr      = 0080C84CEA63
Network Type         = 0x0800 (TCP/IP)
```

IP Header:

```
IP Version           = 4
Header Length        = 20
Type of Service      = 0x00 (0)
Total Length         = 0x0030 (48)
Identification       = 0x330B (13067)
Flags                = 0x02
Fragment Offset      = 0x00
Time to Live         = 0x80 (128)
Protocol             = 0x06 (TCP)
Header Checksum      = 0x3E71 (15985)
Source IP            = 0xC0A80102 (192.168.1.2)
Destination IP       = 0xC01F0782 (192.31.7.130)
```

TCP Header:

```
Source Port          = 0x045C (1116)
Destination Port     = 0x0050 (80)
Sequence Number      = 0x00BD15A7 (12391847)
```

```

Ack Number           = 0x00000000 (0)
Header Length        = 28
Flags                = 0x02 (...S.)
Window Size          = 0x2000 (8192)
Checksum             = 0xBEC3 (48835)
Urgent Ptr           = 0x0000 (0)
Options              =
    0000: 02 04 05 B4 01 01 04 02

```

RAW DATA:

```

0000: 00 A0 C5 92 13 11 00 80-C8 4C EA 63 08 00 45 00 .....L.c..E.
0010: 00 30 33 0B 40 00 80 06-3E 71 C0 A8 01 02 C0 1F .03.@...>q.....
0020: 07 82 04 5C 00 50 00 BD-15 A7 00 00 00 00 70 02 ...\.P.....p.
0030: 20 00 BE C3 00 00 02 04-05 B4 01 01 04 02 .....

```

---<0001>-----

```

LAN Frame: ENETO-XMIT  Size: 58/ 58  Time: 12090.020 sec
Frame Type: TCP 192.31.7.130:80->192.168.1.2:1116

```

Ethernet Header:

```

Destination MAC Addr = 0080C84CEA63
Source MAC Addr      = 00A0C5921311
Network Type         = 0x0800 (TCP/IP)

```

IP Header:

```

IP Version           = 4
Header Length        = 20
Type of Service      = 0x00 (0)
Total Length         = 0x002C (44)
Identification       = 0x57F3 (22515)
Flags                = 0x02
Fragment Offset      = 0x00
Time to Live         = 0xED (237)
Protocol             = 0x06 (TCP)
Header Checksum      = 0xAC8C (44172)
Source IP            = 0xC01F0782 (192.31.7.130)

```

Destination IP = 0xC0A80102 (192.168.1.2)

TCP Header:

Source Port = 0x0050 (80)
Destination Port = 0x045C (1116)
Sequence Number = 0x4AD1B57F (1255257471)
Ack Number = 0x00BD15A8 (12391848)
Header Length = 24
Flags = 0x12 (.A..S.)
Window Size = 0xFAF0 (64240)
Checksum = 0xF877 (63607)
Urgent Ptr = 0x0000 (0)
Options =

0000: 02 04 05 B4

RAW DATA:

0000: 00 80 C8 4C EA 63 00 A0-C5 92 13 11 08 00 45 00 ...L.c.....E.
0010: 00 2C 57 F3 40 00 ED 06-AC 8C C0 1F 07 82 C0 A8 ..W.@.....
0020: 01 02 00 50 04 5C 4A D1-B5 7F 00 BD 15 A8 60 12 ...P.\J.....`.
0030: FA F0 F8 77 00 00 02 04-05 B4 ...w.....

---<0002>-----

LAN Frame: ENETO-RECV Size: 60/ 60 Time: 12090.210 sec
Frame Type: TCP 192.168.1.2:1116->192.31.7.130:80

Ethernet Header:

Destination MAC Addr = 00A0C5921311
Source MAC Addr = 0080C84CEA63
Network Type = 0x0800 (TCP/IP)

IP Header:

IP Version = 4
Header Length = 20
Type of Service = 0x00 (0)
Total Length = 0x0028 (40)
Identification = 0x350B (13579)

```

Flags                = 0x02
Fragment Offset      = 0x00
Time to Live         = 0x80 (128)
Protocol             = 0x06 (TCP)
Header Checksum      = 0x3C79 (15481)
Source IP            = 0xC0A80102 (192.168.1.2)
Destination IP       = 0xC01F0782 (192.31.7.130)

```

TCP Header:

```

Source Port          = 0x045C (1116)
Destination Port     = 0x0050 (80)
Sequence Number      = 0x00BD15A8 (12391848)
Ack Number           = 0x4AD1B580 (1255257472)
Header Length        = 20
Flags                = 0x10 (.A....)
Window Size          = 0x2238 (8760)
Checksum             = 0xE8ED (59629)
Urgent Ptr           = 0x0000 (0)

```

TCP Data: (Length=6, Captured=6)

```
0000: 20 20 20 20 20 20
```

RAW DATA:

```

0000: 00 A0 C5 92 13 11 00 80-C8 4C EA 63 08 00 45 00 .....L.c..E.
0010: 00 28 35 0B 40 00 80 06-3C 79 C0 A8 01 02 C0 1F .(5.@...<y.....
0020: 07 82 04 5C 00 50 00 BD-15 A8 4A D1 B5 80 50 10 ...\.P....J...P.
0030: 22 38 E8 ED 00 00 20 20-20 20 20 20          "8....

```

2. Trace WAN packet

1.1 Disable to capture the LAN packet by entering: **sys trcp channel enet0 none**

1.2 Enable to capture the WAN packet by entering: **sys trcp channel enet1 bothway**

1.3 Enable the trace log by entering: **sys trcp sw on** & **sys trcl sw on**

1.4 Display the brief trace online by entering: **sys trcd brief**

or

1.5 Display the detailed trace online by entering: **sys trcd parse**

Example:

```
Prestige> sys trcp channel enet0 none
Prestige> sys trcp channel enet1 bothway
Prestige> sys trcp sw on
Prestige> sys trcl sw on
Prestige> sys trcd brief
0    12367.680 ENET1-R[0070] UDP 202.132.155.95:520->202.132.155.255:520
1    12370.980 ENET1-T[0062] TCP 202.132.155.97:10261->192.31.7.130:80
2    12373.940 ENET1-T[0062] TCP 202.132.155.97:10261->192.31.7.130:80
3    12374.930 ENET1-R[0064] TCP 192.31.7.130:80->202.132.155.97:10261
4    12374.940 ENET1-T[0054] TCP 202.132.155.97:10261->192.31.7.130:80
5    12374.940 ENET1-T[0438] TCP 202.132.155.97:10261->192.31.7.130:80
6    12375.320 ENET1-R[0064] TCP 192.31.7.130:80->202.132.155.97:10261
7    12375.360 ENET1-R[0090] UDP 202.132.155.95:520->202.132.155.255:520
Prestige> sys trcd parse
---<0000>-----
LAN Frame: ENET1-RECV  Size:1181/ 96  Time: 12387.260 sec
Frame Type: TCP 192.31.7.130:80->202.132.155.97:10270

Ethernet Header:
  Destination MAC Addr    = 00A0C5921312
  Source MAC Addr        = 00A0C5012345
  Network Type           = 0x0800 (TCP/IP)

IP Header:
  IP Version              = 4
  Header Length           = 20
  Type of Service         = 0x00 (0)
  Total Length            = 0x048B (1163)
  Identification         = 0xB139 (45369)
  Flags                   = 0x02
  Fragment Offset         = 0x00
  Time to Live            = 0xEE (238)
  Protocol                = 0x06 (TCP)
  Header Checksum        = 0xA9AB (43435)
```

Source IP = 0xC01F0782 (192.31.7.130)
 Destination IP = 0xCA849B61 (202.132.155.97)

TCP Header:

Source Port = 0x0050 (80)
 Destination Port = 0x281E (10270)
 Sequence Number = 0xD3E95985 (3555285381)
 Ack Number = 0x00C18F63 (12685155)
 Header Length = 20
 Flags = 0x19 (.AP..F)
 Window Size = 0xFAF0 (64240)
 Checksum = 0x3735 (14133)
 Urgent Ptr = 0x0000 (0)

TCP Data: (Length=1127, Captured=42)

0000: DF 33 AF 62 58 37 52 3D-79 99 A5 3C 2B 59 E2 78 .3.bX7R=y.<+Y.x
 0010: A7 98 8F 3F A9 09 E4 0F-26 14 9C 58 3E 95 3E E7 ...?...&..X>.>.
 0020: FC 2A 4C 2F FB BE 2F FE-EF D0 .*L/.../...

RAW DATA:

0000: 00 A0 C5 92 13 12 00 A0-C5 01 23 45 08 00 45 00#E..E.
 0010: 04 8B B1 39 40 00 EE 06-A9 AB C0 1F 07 82 CA 84 ...9@.....
 0020: 9B 61 00 50 28 1E D3 E9-59 85 00 C1 8F 63 50 19 .a.P(...Y....cP.
 0030: FA F0 37 35 00 00 DF 33-AF 62 58 37 52 3D 79 99 ..75...3.bX7R=y.
 0040: A5 3C 2B 59 E2 78 A7 98-8F 3F A9 09 E4 0F 26 14 .<+Y.x...?...&.
 0050: 9C 58 3E 95 3E E7 FC 2A-4C 2F FB BE 2F FE EF D0 .X>.>...*L/.../...

---<0001>-----

LAN Frame: ENET1-XMIT Size: 54/ 54 Time: 12387.490 sec

Frame Type: TCP 202.132.155.97:10270->192.31.7.130:80

Ethernet Header:

Destination MAC Addr = 00A0C5012345
 Source MAC Addr = 00A0C5921312
 Network Type = 0x0800 (TCP/IP)

IP Header:

IP Version = 4
Header Length = 20
Type of Service = 0x00 (0)
Total Length = 0x0028 (40)
Identification = 0x7A0C (31244)
Flags = 0x02
Fragment Offset = 0x00
Time to Live = 0x7F (127)
Protocol = 0x06 (TCP)
Header Checksum = 0x543C (21564)
Source IP = 0xCA849B61 (202.132.155.97)
Destination IP = 0xC01F0782 (192.31.7.130)

TCP Header:

Source Port = 0x281E (10270)
Destination Port = 0x0050 (80)
Sequence Number = 0x00C18F63 (12685155)
Ack Number = 0xD3E95DE9 (3555286505)
Header Length = 20
Flags = 0x10 (.A....)
Window Size = 0x1DD5 (7637)
Checksum = 0x7A12 (31250)
Urgent Ptr = 0x0000 (0)

RAW DATA:

0000: 00 A0 C5 01 23 45 00 A0-C5 92 13 12 08 00 45 00#E.....E.
0010: 00 28 7A 0C 40 00 7F 06-54 3C CA 84 9B 61 C0 1F .(z.@...T<...a..
0020: 07 82 28 1E 00 50 00 C1-8F 63 D3 E9 5D E9 50 10 ..(..P...c..].P.
0030: 1D D5 7A 12 00 00 ..z...

---<0002>-----

LAN Frame: ENET1-XMIT Size: 54/ 54 Time: 12387.490 sec

Frame Type: TCP 202.132.155.97:10270->192.31.7.130:80

Ethernet Header:

Destination MAC Addr = 00A0C5012345
 Source MAC Addr = 00A0C5921312
 Network Type = 0x0800 (TCP/IP)

IP Header:

IP Version = 4
 Header Length = 20
 Type of Service = 0x00 (0)
 Total Length = 0x0028 (40)
 Identification = 0x7B0C (31500)
 Flags = 0x02
 Fragment Offset = 0x00
 Time to Live = 0x7F (127)
 Protocol = 0x06 (TCP)
 Header Checksum = 0x533C (21308)
 Source IP = 0xCA849B61 (202.132.155.97)
 Destination IP = 0xC01F0782 (192.31.7.130)

TCP Header:

Source Port = 0x281E (10270)
 Destination Port = 0x0050 (80)
 Sequence Number = 0x00C18F63 (12685155)
 Ack Number = 0xD3E95DE9 (3555286505)
 Header Length = 20
 Flags = 0x11 (.A...F)
 Window Size = 0x1DD5 (7637)
 Checksum = 0x7A11 (31249)
 Urgent Ptr = 0x0000 (0)

RAW DATA:

```
0000: 00 A0 C5 01 23 45 00 A0-C5 92 13 12 08 00 45 00 ....#E.....E.
0010: 00 28 7B 0C 40 00 7F 06-53 3C CA 84 9B 61 C0 1F .({.@...S<...a..
0020: 07 82 28 1E 00 50 00 C1-8F 63 D3 E9 5D E9 50 11 ..(..P...c...].P.
```

```
0030: 1D D5 7A 11 00 00          ..Z...  
Prestige>
```

Offline Trace

1. Trace LAN packet
 2. Trace WAN packet
-

1. Trace LAN packet

- 1.1 Disable to capture the WAN packet by entering: **sys trcp channel enet1 none**
- 1.2 Enable to capture the LAN packet by entering: **sys trcp channel enet0 bothway**
- 1.3 Enable the trace log by entering: **sys trcp sw on & sys trcl sw on**
- 1.4 Wait for packet passing through Prestige over LAN
- 1.5 Disable the trace log by entering: **sys trcp sw off & sys trcl sw off**
- 1.6 Display the trace briefly by entering: **sys trcp brief**
- 1.7 Display specific packets by using: **sys trcp parse <from_index> <to_index>**

Exmample:

```
Prestige> sys trcp channel enet1 none  
Prestige> sys trcp channel enet0 bothway  
Prestige> sys trcp sw on  
Prestige> sys trcl sw on  
Prestige> sys trcp sw off  
Prestige> sys trcl sw off  
Prestige> sys trcp brief  
 0  10855.790 ENET0-T[0141] TCP 192.31.7.130:80->192.168.1.2:1102  
 1  10855.800 ENET0-R[0060] TCP 192.168.1.2:1102->192.31.7.130:80  
 2  10855.810 ENET0-R[0062] TCP 192.168.1.2:1103->192.31.7.130:80  
 3  10855.840 ENET0-R[0062] TCP 192.168.1.2:1104->192.31.7.130:80  
 4  10856.020 ENET0-T[0054] TCP 192.31.7.130:80->192.168.1.2:1102
```

5 10856.030 ENETO-T[0058] TCP 192.31.7.130:80->192.168.1.2:1103

6 10856.040 ENETO-R[0060] TCP 192.168.1.2:1103->192.31.7.130:80

Prestige> sys trcp parse 5 5

---<0005>-----

LAN Frame: ENETO-XMIT Size: 58/ 58 Time: 10856.030 sec

Frame Type: TCP 192.31.7.130:80->192.168.1.2:1103

Ethernet Header:

Destination MAC Addr = 0080C84CEA63
 Source MAC Addr = 00A0C5921311
 Network Type = 0x0800 (TCP/IP)

IP Header:

IP Version = 4
 Header Length = 20
 Type of Service = 0x00 (0)
 Total Length = 0x002C (44)
 Identification = 0x7F02 (32514)
 Flags = 0x02
 Fragment Offset = 0x00
 Time to Live = 0xED (237)
 Protocol = 0x06 (TCP)
 Header Checksum = 0x857D (34173)
 Source IP = 0xC01F0782 (192.31.7.130)
 Destination IP = 0xC0A80102 (192.168.1.2)

TCP Header:

Source Port = 0x0050 (80)
 Destination Port = 0x044F (1103)
 Sequence Number = 0xD91B1826 (3642431526)
 Ack Number = 0x00AA405F (11157599)

```

Header Length      = 24
Flags              = 0x12 (.A..S.)
Window Size       = 0xFAF0 (64240)
Checksum          = 0xDCEF (56559)
Urgent Ptr        = 0x0000 (0)
Options           =
    0000: 02 04 05 B4

RAW DATA:
0000: 00 80 C8 4C EA 63 00 A0-C5 92 13 11 08 00 45 00 ...L.c.....E.
0010: 00 2C 7F 02 40 00 ED 06-85 7D C0 1F 07 82 C0 A8 ...@....}.....
0020: 01 02 00 50 04 4F D9 1B-18 26 00 AA 40 5F 60 12 ...P.O...&..@_`.
0030: FA F0 DC EF 00 00 02 04-05 B4 .....

Prestige>

```

2. Trace WAN packet

- 1.1 Disable to capture the LAN packet by entering: **sys trcp channel enet0 none**
- 1.2 Enable to capture the WAN packet by entering: **sys trcp channel enet1 bothway**
- 1.3 Enable the trace log by entering: **sys trcp sw on & sys trcl sw on**
- 1.4 Wait for packet passing through Prestige over WAN
- 1.5 Disable the trace log by entering: **sys trcp sw off & sys trcl sw off**
- 1.6 Display the trace briefly by entering: **sys trcp brief**
- 1.7 Display specific packets by using: **sys trcp parse <from_index> <to_index>**

Example:

```

Prestige> sys trcp channel enet0 none
Prestige> sys trcp channel enet1 bothway
Prestige> sys trcl sw on
Prestige> sys trcp sw on
Prestige> sys trcl sw off
Prestige> sys trcp sw off
Prestige> sys trcp brief
 0   12864.800 ENET1-T[0411] TCP 202.132.155.97:10278->204.217.0.2:80
 1   12864.890 ENET1-R[0247] TCP 204.217.0.2:80->202.132.155.97:10282

```



```
2 12864.900 ENET1-T[0416] TCP 202.132.155.97:10282->204.217.0.2:80
3 12865.120 ENET1-R[0247] TCP 204.217.0.2:80->202.132.155.97:10278
4 12865.130 ENET1-T[0411] TCP 202.132.155.97:10278->204.217.0.2:80
5 12865.220 ENET1-R[0247] TCP 204.217.0.2:80->202.132.155.97:10282
```

```
Prestige> sys trcp parse 3 4
```

```
---<0003>-----
```

```
LAN Frame: ENET1-RECV Size: 247/ 96 Time: 12865.120 sec
```

```
Frame Type: TCP 204.217.0.2:80->202.132.155.97:10278
```

Ethernet Header:

```
Destination MAC Addr = 00A0C5921312
Source MAC Addr      = 00A0C5591284
Network Type         = 0x0800 (TCP/IP)
```

IP Header:

```
IP Version           = 4
Header Length        = 20
Type of Service      = 0x00 (0)
Total Length         = 0x00E5 (229)
Identification       = 0xE93B (59707)
Flags                = 0x02
Fragment Offset      = 0x00
Time to Live         = 0xF0 (240)
Protocol              = 0x06 (TCP)
Header Checksum      = 0x6E15 (28181)
Source IP             = 0xCCD90002 (204.217.0.2)
Destination IP       = 0xCA849B61 (202.132.155.97)
```

TCP Header:

```
Source Port          = 0x0050 (80)
Destination Port     = 0x2826 (10278)
Sequence Number      = 0x4D713D8A (1299266954)
Ack Number           = 0x00C8C015 (13156373)
Header Length        = 20
Flags                = 0x18 (.AP...)
```

```

Window Size           = 0x2238 (8760)
Checksum              = 0xAB57 (43863)
Urgent Ptr            = 0x0000 (0)

```

TCP Data: (Length=193, Captured=42)

```

0000: 48 54 54 50 2F 31 2E 31-20 33 30 34 20 4E 6F 74 HTTP/1.1 304 Not
0010: 20 4D 6F 64 69 66 69 65-64 0D 0A 44 61 74 65 3A Modified..Date:
0020: 20 57 65 64 2C 20 30 37-20 4A Wed, 07 J

```

RAW DATA:

```

0000: 00 A0 C5 92 13 12 00 A0-C5 59 12 84 08 00 45 00 .....Y....E.
0010: 00 E5 E9 3B 40 00 F0 06-6E 15 CC D9 00 02 CA 84 ...;@...n.....
0020: 9B 61 00 50 28 26 4D 71-3D 8A 00 C8 C0 15 50 18 .a.P(&Mq=....P.
0030: 22 38 AB 57 00 00 48 54-54 50 2F 31 2E 31 20 33 "8.W..HTTP/1.1 3
0040: 30 34 20 4E 6F 74 20 4D-6F 64 69 66 69 65 64 0D 04 Not Modified.
0050: 0A 44 61 74 65 3A 20 57-65 64 2C 20 30 37 20 4A .Date: Wed, 07 J

```

---<0004>-----

```

LAN Frame: ENET1-XMIT Size: 411/ 96 Time: 12865.130 sec
Frame Type: TCP 202.132.155.97:10278->204.217.0.2:80

```

Ethernet Header:

```

Destination MAC Addr = 00A0C5591284
Source MAC Addr      = 00A0C5921312
Network Type         = 0x0800 (TCP/IP)

```

IP Header:

```

IP Version           = 4
Header Length        = 20
Type of Service      = 0x00 (0)
Total Length         = 0x018D (397)
Identification       = 0xF20C (61964)
Flags                 = 0x02
Fragment Offset      = 0x00
Time to Live         = 0x7F (127)
Protocol              = 0x06 (TCP)

```

```
Header Checksum      = 0xD59C (54684)
Source IP            = 0xCA849B61 (202.132.155.97)
Destination IP      = 0xCCD90002 (204.217.0.2)

TCP Header:
Source Port          = 0x2826 (10278)
Destination Port    = 0x0050 (80)
Sequence Number     = 0x00C8C015 (13156373)
Ack Number          = 0x4D713E47 (1299267143)
Header Length       = 20
Flags                = 0x18 (.AP...)
Window Size         = 0x1E87 (7815)
Checksum            = 0x4374 (17268)
Urgent Ptr          = 0x0000 (0)

TCP Data: (Length=357, Captured=42)
0000: 47 45 54 20 2F 70 69 63-74 75 72 65 73 2F 6D 61  GET /pictures/ma
0010: 67 61 7A 69 6E 65 5F 6C-6F 67 6F 2F 62 65 73 74  gazine_logo/best
0020: 6F 66 74 69 6D 65 73 2E-67 69                          oftimes.gi

RAW DATA:
0000: 00 A0 C5 59 12 84 00 A0-C5 92 13 12 08 00 45 00  ...Y.....E.
0010: 01 8D F2 0C 40 00 7F 06-D5 9C CA 84 9B 61 CC D9  ....@.....a..
0020: 00 02 28 26 00 50 00 C8-C0 15 4D 71 3E 47 50 18  ..(&.P....Mq>GP.
0030: 1E 87 43 74 00 00 47 45-54 20 2F 70 69 63 74 75  ..Ct..GET /pictu
0040: 72 65 73 2F 6D 61 67 61-7A 69 6E 65 5F 6C 6F 67  res/magazine_log
0050: 6F 2F 62 65 73 74 6F 66-74 69 6D 65 73 2E 67 69  o/bestoftimes.gi
Prestige>
```

Debug PPPoE Connection

Debug PPPoE Connection

The Prestige supports traces when there is problem to connect your ISP using PPPoE protocol. Please follow the procedure below to collect the trace for our troubleshooting.

1. Remove the LAN cable attached on the Prestige
2. Enter SMT using console port
3. Enter Menu 24.8-CI command mode
4. Type the following commands:
 - `sys trcp sw on` (turn on packet trace)
 - `sys errctl 3` (save crash information and make system enter debug mode after the crash)
 - `poe debug 1` (turn on pppoe debug)
 - `dev dial 1` (dial remote node 1)
5. After all, if the Prestige crashes and you can do nothing, please send the above log back to us.
6. If the Prestige crashes and you are able to enter commands, please type 'atds' in debug mode to dump the log and send the log to us.
7. If the Prestige does not crash but just can not dial out, please capture the following further log and send us the log.
 - `sys trcp sw off` (turn off packet trace)
 - `sys log disp i` (capture system error log)
 - `sys trcp parse` (parse the trace in detail)

Example- A trace with system crashes

```
ras> sys trcp sw on
ras> sys errctl 3
ras> poe debug 1
ras> dev dial 1
Start dialing for node <GPMI>...
poeNetCmdExe: chann poe0 event x420
poeChannDial: start session, peer<GPMI>
bdcastInit: pch poe0
poePut1SrvName: '' len 0
host-uniq 31303030 len 4
```

```
putPoeHdr: ver 1 type 1 code x09 sess-id 0 len 12(x000C)
bdcastSendInit: ll.pktTx() failed, pch poe0 ch enet0
poePut1SrvcName: '' len 0
host-uniq 31303030 len 4
putPoeHdr: ver 1 type 1 code x09 sess-id 0 len 12(x000C)
### Hit any key to continue.###
$$$ DIALING dev=6 ch=0.....
poeI/C: ver 1 type 1 code x07 sessId x0000 len 274(x0112)
poeCtrlI/C: pkt len 274
poeGetTags()
service-name
service-name telstra
service-name bpa
service-name iprimus
service-name pacificinternet
service-name integrationisp
service-name bpa-dev
service-name bpa-sif
service-name telstrarna
service-name gpmsystems
service-name cmux
service-name launceston-broadband
service-name vivanet
service-name n1234567k00
service-name bigpond
service-name n7061992k
service-name n3068223k
service-name n2155202k
service-name n7061995k
AC-name vet1-exhibition-bsn-1
host-uniq 31303030 len 4
PADO recv'd, chann enet1
procPADO: for poe chann poe0
Chann poe0 sending request
poePut1SrvcName: '' len 0
host-uniq 31303030 len 4
putPoeHdr: ver 1 type 1 code x19 sess-id 0 len 12(x000C)
```

Undefined Address : 0xE3F045C4

Undefined Data : 0x56FF54FF

r0= 0xE3F045C4	r1= 0x0001FFC0	r2= 0x000000E5	r3= 0x56FF54FF
r4= 0xE3F045C4	r5= 0xE5BDBFEC	r6= 0x0001C468	r7= 0x60000093
r8= 0x00000000	r9= 0xE3550000	r10=0xE3550000	fp= 0x00000000
r12=0x56FF54FF	sp= 0x0001EDBC	lr= 0x00004F64	pc= 0x00013954

00 01 02 03 04 05 06 07 08 09 0A 0B 0C 0D 0E 0F

```

e5bdbfe0: e2 8f 00 06 e5 d5 20 06 e5 d5 20 0a e5 d5 20 0e ...b...f...j...n
e5bdbff0: 00 00 00 00 00 00 00 00 00 00 00 00 00 01 ed 2b ...b...f...j...n
e5bdc000: 00 00 00 00 00 00 00 00 00 00 00 00 00 01 ed 2b ...b...f...j...n
e5bdc010: 00 00 00 00 00 00 00 00 00 00 00 00 00 01 ed 2b ...b...f...j...n
e5bdc020: 00 00 00 00 00 00 00 00 00 00 00 00 00 01 ed 2b ...b...f...j...n
e5bdc030: 00 00 00 00 00 00 00 00 00 00 00 00 00 01 ed 2b ...b...f...j...n
e5bdc040: 00 00 00 00 00 00 00 00 00 00 00 00 00 01 ed 2b ...b...f...j...n
e5bdc050: 00 00 00 00 00 00 00 00 00 00 00 00 00 01 ed 2b ...b...f...j...n
e5bdc060: 00 00 00 00 00 00 00 00 00 00 00 00 00 01 ed 2b ...b...f...j...n
e5bdc070: 00 00 00 00 00 00 00 00 00 00 00 00 00 01 ed 2b ...b...f...j...n
e5bdc080: 00 00 00 00 00 00 00 00 00 00 00 00 00 01 ed 2b ...b...f...j...n
e5bdc090: 00 00 00 00 00 00 00 00 00 00 00 00 00 01 ed 2b ...b...f...j...n
e5bdc0a0: 00 00 00 00 00 00 00 00 00 00 00 00 00 01 ed 2b ...b...f...j...n
e5bdc0b0: 00 00 00 00 00 00 00 00 00 00 00 00 00 01 ed 2b ...b...f...j...n
e5bdc0c0: 00 00 00 00 00 00 00 00 00 00 00 00 00 01 ed 2b ...b...f...j...n
e5bdc0d0: 00 00 00 00 00 00 00 00 00 00 00 00 00 01 ed 2b ...b...f...j...n
e5bdc0e0: 00 00 00 00 00 00 00 00 00 00 00 00 00 01 ed 2b ...b...f...j...n

```

Bootbase Version: V1.10 | 12/02/2004 14:00:00

RAM: Size = 16384 Kbytes

FLASH: Intel 16M *1

ZyNOS Version: V3.40(RE.0) | 01/27/2005 15:00:00

Enter Debug Mode

atgo

(Compressed)

Version: RAS P2602R, start: bfc58030

Length: 3DB3EC, Checksum: 9AA9

Compressed Length: 12AC58, Checksum: DC06

Copyright (c) 1994 - 2004 ZyXEL Communications Corp.

```
initialize ch = 0, ethernet address: 00:a0:c5:d1:78:e9
Wan Channel init ..... done
..... done
VC5402 Init...OK
Press ENTER to continue...
      Enter Password : XXXX
```

LAN/WAN Packet Trace

The Prestige packet trace records and analyzes packets running on LAN and WAN interfaces. It is designed for users with technical backgrounds who are interested in the details of the packet flow on LAN or WAN end of Prestige. It is also very helpful for diagnostics if you have compatibility problems with your ISP or if you want to know the details of a packet for configuring a filter rule.

The format of the display is as following:

Packet:

```
0 11880.160 ENET0-R[0062] TCP 192.168.1.2:1108->192.31.7.130:80
```

[index] [timer/second][channel-receive/transmit][length] [protocol] [sourceIP/port] [destIP/port]

There are two ways to dump the trace:

1. **Online Trace--display the trace real time on screen**
2. **Offline Trace--capture the trace first and display later**

The details for capturing the trace in SMT menu 24.8 are as follows.

Online Trace

1. Trace LAN packet
 2. Trace WAN packet
-

1. Trace LAN packet

- 1.1 Disable to capture the WAN packet by entering: **sys trcp channel mpoa00 none**
 - 1.2 Enable to capture the LAN packet by entering: **sys trcp channel enet0 bothway**
 - 1.3 Enable the trace log by entering: **sys trcp sw on** & **sys trcl sw on**
 - 1.4 Display the brief trace online by entering: **sys trcd brief**
- or
- 1.5 Display the detailed trace online by entering: **sys trcd parse**

Example:

```
ras> sys trcp channel mpoa00 none
ras> sys trcp channel enet0 bothway
ras> sys trcp sw on
ras> sys trcl sw on
ras> sys trcd brief
 0  11880.160 ENET0-R[0062] TCP 192.168.1.2:1108->192.31.7.130:80
 1  11883.100 ENET0-R[0062] TCP 192.168.1.2:1108->192.31.7.130:80
 2  11883.330 ENET0-T[0058] TCP 192.31.7.130:80->192.168.1.2:1108
 3  11883.340 ENET0-R[0060] TCP 192.168.1.2:1108->192.31.7.130:80
 4  11883.340 ENET0-R[0339] TCP 192.168.1.2:1108->192.31.7.130:80
 5  11883.610 ENET0-T[0054] TCP 192.31.7.130:80->192.168.1.2:1108
 6  11883.620 ENET0-T[0102] TCP 192.31.7.130:80->192.168.1.2:1108
 7  11883.630 ENET0-T[0054] TCP 192.31.7.130:80->192.168.1.2:1108
 8  11883.630 ENET0-R[0060] TCP 192.168.1.2:1108->192.31.7.130:80
 9  11883.2602HW ENET0-R[0060] TCP 192.168.1.2:1108->192.31.7.130:80
10  11883.2602HW ENET0-R[0062] TCP 192.168.1.2:1109->192.31.7.130:80
ras> sys trcd parse
---<0000>-----
LAN Frame: ENET0-RECV  Size: 62/ 62  Time: 12089.790 sec
Frame Type: TCP 192.168.1.2:1116->192.31.7.130:80

Ethernet Header:
  Destination MAC Addr    = 00A0C5921311
  Source MAC Addr        = 0080C84CEA63
  Network Type           = 0x0800 (TCP/IP)
```

IP Header:

```

IP Version           = 4
Header Length       = 20
Type of Service     = 0x00 (0)
Total Length        = 0x0030 (48)
Identification      = 0x330B (13067)
Flags               = 0x02
Fragment Offset     = 0x00
Time to Live        = 0x80 (128)
Protocol            = 0x06 (TCP)
Header Checksum     = 0x3E71 (15985)
Source IP           = 0xC0A80102 (192.168.1.2)
Destination IP      = 0xC01F0782 (192.31.7.130)
    
```

TCP Header:

```

Source Port          = 0x045C (1116)
Destination Port     = 0x0050 (80)
Sequence Number      = 0x00BD15A7 (12391847)
Ack Number           = 0x00000000 (0)
Header Length        = 28
Flags                = 0x02 (...S.)
Window Size          = 0x2004 (8192)
Checksum             = 0xBEC3 (48835)
Urgent Ptr           = 0x0000 (0)
Options              =
    0000: 02 04 05 B4 01 01 04 02
    
```

RAW DATA:

```

0000: 00 A0 C5 92 13 11 00 80-C8 4C EA 63 08 00 45 00 .....L.c..E.
0010: 00 30 33 0B 40 00 80 06-3E 71 C0 A8 01 02 C0 1F .03.@...>q.....
0020: 07 82 04 5C 00 50 00 BD-15 A7 00 00 00 00 70 02 ...\.P.....p.
0030: 20 00 BE C3 00 00 02 04-05 B4 01 01 04 02 .....
    
```

---<0001>-----

LAN Frame: ENET0-XMIT Size: 58/ 58 Time: 12090.020 sec

Frame Type: TCP 192.31.7.130:80->192.168.1.2:1116

Ethernet Header:

Destination MAC Addr = 0080C84CEA63
Source MAC Addr = 00A0C5921311
Network Type = 0x0800 (TCP/IP)

IP Header:

IP Version = 4
Header Length = 20
Type of Service = 0x00 (0)
Total Length = 0x002C (44)
Identification = 0x57F3 (22515)
Flags = 0x02
Fragment Offset = 0x00
Time to Live = 0xED (237)
Protocol = 0x06 (TCP)
Header Checksum = 0xAC8C (44172)
Source IP = 0xC01F0782 (192.31.7.130)
Destination IP = 0xC0A80102 (192.168.1.2)

TCP Header:

Source Port = 0x0050 (80)
Destination Port = 0x045C (1116)
Sequence Number = 0x4AD1B57F (1255257471)
Ack Number = 0x00BD15A8 (12391848)
Header Length = 24
Flags = 0x12 (.A..S.)
Window Size = 0xFAF0 (2602HW40)
Checksum = 0xF877 (63607)
Urgent Ptr = 0x0000 (0)
Options =

0000: 02 04 05 B4

RAW DATA:

0000: 00 80 C8 4C EA 63 00 A0-C5 92 13 11 08 00 45 00 ...L.c.....E.
0010: 00 2C 57 F3 40 00 ED 06-AC 8C C0 1F 07 82 C0 A8 ..W.@.....
0020: 01 02 00 50 04 5C 4A D1-B5 7F 00 BD 15 A8 60 12 ...P.\J.....`.
0030: FA F0 F8 77 00 00 02 04-05 B4 ...w.....

---<0002>-----

LAN Frame: ENETO-RECV Size: 60/ 60 Time: 12090.210 sec

Frame Type: TCP 192.168.1.2:1116->192.31.7.130:80

Ethernet Header:

Destination MAC Addr = 00A0C5921311
Source MAC Addr = 0080C84CEA63
Network Type = 0x0800 (TCP/IP)

IP Header:

IP Version = 4
Header Length = 20
Type of Service = 0x00 (0)
Total Length = 0x0028 (40)
Identification = 0x350B (13579)
Flags = 0x02
Fragment Offset = 0x00
Time to Live = 0x80 (128)
Protocol = 0x06 (TCP)
Header Checksum = 0x3C79 (15481)
Source IP = 0xC0A80102 (192.168.1.2)
Destination IP = 0xC01F0782 (192.31.7.130)

TCP Header:

Source Port = 0x045C (1116)
Destination Port = 0x0050 (80)
Sequence Number = 0x00BD15A8 (12391848)
Ack Number = 0x4AD1B580 (1255257472)
Header Length = 20
Flags = 0x10 (.A....)
Window Size = 0x2238 (8760)

```

Checksum                = 0xE8ED (59629)
Urgent Ptr              = 0x0000 (0)

TCP Data: (Length=6, Captured=6)
0000: 20 20 20 20 20 20

RAW DATA:
0000: 00 A0 C5 92 13 11 00 80-C8 4C EA 63 08 00 45 00 .....L.c..E.
0010: 00 28 35 0B 40 00 80 06-3C 79 C0 A8 01 02 C0 1F .(5.@...<y.....
0020: 07 82 04 5C 00 50 00 BD-15 A8 4A D1 B5 80 50 10 ...\.P....J...P.
0030: 22 38 E8 ED 00 00 20 20-20 20 20 20          "8....

```

2. Trace WAN packet

- 1.1 Disable the capture of the LAN packet by entering: **sys trcp channel enet0 none**
 - 1.2 Enable to capture the WAN packet by entering: **sys trcp channel mpoa00 bothway**
 - 1.3 Enable the trace log by entering: **sys trcp sw on & sys trcl sw on**
 - 1.4 Display the brief trace online by entering: **sys trcd brief**
- or
- 1.5 Display the detailed trace online by entering: **sys trcd parse**

Example:

```

ras> sys trcp channel enet0 none
ras> sys trcp channel mpoa00 bothway
ras> sys trcp sw on
ras> sys trcl sw on
ras> sys trcd brief
0   12367.680 MPOA00-R[0070] UDP 202.132.155.95:520->202.132.155.255:520
1   12370.980 MPOA00-T[0062] TCP 202.132.155.97:10261->192.31.7.130:80
ras> sys trcd parse
---<0000>-----
LAN Frame: MPOA00-RECV   Size:1181/ 96   Time: 12387.260 sec
Frame Type: TCP 192.31.7.130:80->202.132.155.97:10270

Ethernet Header:
  Destination MAC Addr   = 00A0C5921312

```

```

Source MAC Addr      = 00A0C5012345
Network Type        = 0x0800 (TCP/IP)

IP Header:
IP Version          = 4
Header Length       = 20
Type of Service     = 0x00 (0)
Total Length        = 0x048B (1163)
Identification      = 0xB139 (45369)
Flags               = 0x02
Fragment Offset     = 0x00
Time to Live        = 0xEE (238)
Protocol            = 0x06 (TCP)
Header Checksum     = 0xA9AB (43435)
Source IP           = 0xC01F0782 (192.31.7.130)
Destination IP      = 0xCA849B61 (202.132.155.97)

```

```

TCP Header:
Source Port         = 0x0050 (80)
Destination Port    = 0x281E (10270)
Sequence Number     = 0xD3E95985 (3555285381)
Ack Number          = 0x00C18F63 (12685155)
Header Length       = 20
Flags               = 0x19 (.AP..F)
Window Size         = 0xFAF0 (2602HW40)
Checksum            = 0x3735 (14133)
Urgent Ptr          = 0x0000 (0)

```

```

TCP Data: (Length=1127, Captured=42)
0000: DF 33 AF 62 58 37 52 3D-79 99 A5 3C 2B 59 E2 78  .3.bX7R=y..<+Y.x
0010: A7 98 8F 3F A9 09 E4 0F-26 14 9C 58 3E 95 3E E7  ...?...&..X>.>.
0020: FC 2A 4C 2F FB BE 2F FE-EF D0                      .*L/.../...

```

```

RAW DATA:
0000: 00 A0 C5 92 13 12 00 A0-C5 01 23 45 08 00 45 00  .....#E..E.

```

```
0010: 04 8B B1 39 40 00 EE 06-A9 AB C0 1F 07 82 CA 84 ...9@.....
0020: 9B 61 00 50 28 1E D3 E9-59 85 00 C1 8F 63 50 19 .a.P(...Y....cP.
0030: FA F0 37 35 00 00 DF 33-AF 62 58 37 52 3D 79 99 ..75...3.bX7R=y.
0040: A5 3C 2B 59 E2 78 A7 98-8F 3F A9 09 E4 0F 26 14 .<+Y.x...?...&.
0050: 9C 58 3E 95 3E E7 FC 2A-4C 2F FB BE 2F FE EF D0 .X>.>...*L/.../...
```

Offline Trace

1. Trace LAN packet
 2. Trace WAN packet
-

1. Trace LAN packet

- 1.1 Disable the capture of the WAN packet by entering: **sys trcp channel mpoa00 none**
- 1.2 Enable the capture of the LAN packet by entering: **sys trcp channel enet0 bothway**
- 1.3 Enable the trace log by entering: **sys trcp sw on & sys trcl sw on**
- 1.4 Wait for packet passing through the Prestige over LAN
- 1.5 Disable the trace log by entering: **sys trcp sw off & sys trcl sw off**
- 1.6 Display the trace briefly by entering: **sys trcp brief**
- 1.7 Display specific packets by using: **sys trcp parse <from_index> <to_index>**

2. Trace WAN packet

- 1.1 Disable the capture of the LAN packet by entering: **sys trcp channel enet0 none**
- 1.2 Enable the capture of the WAN packet by entering: **sys trcp channel mpoa00 bothway**
- 1.3 Enable the trace log by entering: **sys trcp sw on & sys trcl sw on**
- 1.4 Wait for packet passing through the Prestige over WAN
- 1.5 Disable the trace log by entering: **sys trcp sw off & sys trcl sw off**
- 1.6 Display the trace briefly by entering: **sys trcp brief**
- 1.7 Display specific packets by using: **sys trcp parse <from_index> <to_index>**

CLI Command List

The latest CI command list is available in release notes of every ZyXEL firmware release. Please go to ZyXEL public WEB site <http://www.zyxel.com/support/download.php> to download firmware package (*.zip), you should unzip the package to get the release note in PDF format.