

Infortrend

External RAID Subsystem & Controller



Generic Operation Manual

Revision 1.65

Firmware Version: 3.41 & 3.42



**Asia Pacific
(International Headquarters)
Infortrend Technology, Inc.**
8F, No. 102 Chung-Shan Rd., Sec. 3 Chung-Ho
City, Taipei Hsien, Taiwan
Tel: +886-2-2226-0126
Fax: +886-2-2226-0020
sales@infortrend.com.tw
support@infortrend.com.tw
<http://www.infortrend.com.tw>

China

Infortrend Technology, Ltd.
Room 1210 West Wing, Tower One, Junefield
Plaza, No. 6 Xuanwumen Street Xuanwu District,
Beijing China 100052
Tel: +86-10-63106168
Fax: +86-10-63106188
sales@infortrend.com.cn
support@infortrend.com.cn
<http://www.infortrend.com.cn>

North and South America
Infortrend Corporation
3150 Coronado Drive, Unit C, Santa Clara,
CA 95054 USA
Tel: +1-408-988-5088
Fax: +1-408-988-6288
sales@infortrend.com
support@infortrend.com
<http://www.infortrend.com>

Europe

Infortrend Europe Limited
5 Elmwood, Crockford Lane, Chineham
Business Park, Basingstoke, Hampshire,
RG24 8WG, United Kingdom
Tel: +44-1256-70-77-00
Fax: +44-1256-70-78-89
sales@infortrend-europe.com
support@infortrend-europe.com
<http://www.infortrend-europe.com>

Copyright 2004

This Edition First Published 2004

All rights reserved. No part of this publication may be reproduced, transmitted, transcribed, stored in a retrieval system, or translated into any language or computer language, in any form or by any means, electronic, mechanical, magnetic, optical, chemical, manual or otherwise, without the prior written consent of Infortrend Technology, Inc.

Disclaimer

Infortrend Technology makes no representations or warranties with respect to the contents hereof and specifically disclaims any implied warranties of merchantability or fitness for any particular purpose. Furthermore, Infortrend Technology reserves the right to revise this publication and to make changes from time to time in the content hereof without obligation to notify any person of such revisions or changes. **Product specifications are also subject to change without notice.**

Trademarks

Infortrend and the Infortrend logo are registered trademarks and SentinelRAID, EonRAID, EonStor, RAIDWatch, and other names prefixed with "IFT" are trademarks of Infortrend Technology, Inc.

PowerPC is a registered trademark of International Business Machines Corporation and Motorola Inc.

DEC and Alpha are registered trademarks of Compaq Computer Corp. (formerly of Digital Equipment Corporation). Microsoft, Windows, Windows NT and MS-DOS are registered trademarks of Microsoft Corporation in the U.S. and other countries.

Novell and NetWare are registered trademarks of Novell, Inc. in the U.S. and other countries.

SCO, OpenServer, and UnixWare are trademarks or registered trademarks of The Santa Cruz Operation, Inc. in the U.S. and other countries.

Solaris is a trademark of SUN Microsystems, Inc.

UNIX is a registered trademark of The Open Group in the U.S. and other countries. All other names, brands, products or services are trademarks or registered trademarks of their respective companies.

RMA Policy

Please visit our websites (www.infortrend.com, www.infortrend.com.tw, www.infortrend.com.cn, or www.infortrend-europe.com) where our RMA policy is given a detailed explanation.

Supported Models

This manual supports the following Infortrend controllers/subsystems:

- SentinelRAID: SCSI-based external RAID controllers (including the 5.25" full-height and 1U canister configuration)
- EonRAID: Fibre-based external RAID controllers (including the 1U canister controller head configurations)
- EonStor: subsystems that come with SCSI or Fibre host channels and SCSI, Fibre, or SATA drive interfaces.

Printed in Taiwan

Table of Contents

Functional Table of Contents	xiii
------------------------------------	------

Chapter 1: RAID Functions: An Introduction

1.1 Logical Drive	1-1
1.2 Logical Volume	1-1
What is a logical volume?	1-1
1.3 RAID Levels.....	1-2
What Are the RAID Levels?	1-2
NRAID.....	1-3
JBOD	1-3
RAID 0.....	1-4
RAID 1.....	1-4
RAID (0+1).....	1-4
RAID 3.....	1-5
RAID 5.....	1-5
1.4 Spare Drives.....	1-6
Global and Local Spare Drives	1-6
1.5 Identifying Drives	1-8
Flash Selected Drive	1-8
Flash All Drives	1-8
Flash All but Selected Drives	1-8
1.6 Rebuild	1-9
Automatic Rebuild and Manual Rebuild	1-9
1. Automatic Rebuild	1-9
2. Manual Rebuild.....	1-10
3. Concurrent Rebuild in RAID (0+1)	1-11
1.7 Logical Volume (Multi-Level RAID).....	1-11
What Is a Logical Volume?.....	1-11
Spare Drives Assigned to a Logical Volume?	1-14
Limitations:	1-14
Partitioning the Logical Drive or Partitioning the Logical Volume?	1-15
Different Write Policies within a Logical Volume?	1-15
RAID Expansion with Logical Volume?	1-15
Different Configuration Settings Using Logical Volume?	1-16
Redundant Controller.....	1-16
A Logical Volume with Logical Drives of Different Levels?	1-17
Multi-level RAID Systems.....	1-17

Chapter 2: RAID Planning

2.1 Considerations	2-1
1. How many physical drives do you have?	2-1
2. How many drives on each drive channel?	2-1
3. How many drives would you like to appear to the host computer?	2-2
4. What kind of host application?	2-2
5. Dual loop, hub, or switch?	2-2
6. Optimization Mode	2-3
7. What RAID level?	2-3
8. Any spare drives?	2-4
9. Limitations?	2-4
2.2 Configuring the Array:	2-5

2.2.1 Starting a RAID System.....	2-5
2.3 Operation Theory.....	2-7
2.3.1 I/O Channel, SCSI ID, and LUN	2-7
2.3.2 Grouping Drives into an Array	2-7
2.3.3 Making Arrays Available to Hosts.....	2-9
2.4 Tunable Parameters	2-10

Chapter 3: Accessing the Array: Serial Port, Ethernet, and Access Security

3.1 RS-232C Serial Port.....	3-1
3.1.1 Configuring RS-232C Connection via Front Panel.....	3-2
3.1.2 Starting RS-232C Terminal Emulation	3-3
3.2 Out-of-Band via Ethernet	3-4
What is the “Disk Reserved Space?”.....	3-4
Other Concerns	3-4
Web-based Management	3-5
3.2.1 Connecting Ethernet Port:	3-5
3.2.2 Configuring the Controller.....	3-5
3.3 Secure Link over SSH	3-7

Chapter 4: LCD Screen Messages

4.1 The Initial Screen	4-1
4.2 Quick Installation Screen.....	4-1
4.3 Logical Drive Status	4-2
4.4 Logical Volume Status	4-3
4.5 SCSI Drive Status.....	4-4
4.6 SCSI Channel Status	4-5
4.7 Controller Voltage and Temperature	4-6
4.8 Cache Dirty Percentage	4-7
4.9 View and Edit Event Logs.....	4-7

Chapter 5: LCD Keypad Operation

5.1 Power On the RAID Enclosure	5-1
5.2 Caching Parameters	5-1
Optimization Modes	5-1
Optimization Mode and Stripe Size	5-2
Optimization for Random or Sequential I/O.....	5-3
Write-back/Write-through Cache Enable/Disable.....	5-3
Periodic Cache Flush.....	5-4
5.3 View Connected Drives:.....	5-5
5.4 Creating a Logical Drive.....	5-6
Choosing a RAID Level	5-6
Choosing Member Drives	5-6
Logical Drive Preferences.....	5-6
Maximum Drive Capacity.....	5-7
Spare Drive Assignments	5-7
Disk Reserved Space	5-7
Write Policy	5-7
Initialization Mode	5-8
Stripe Size.....	5-8
Beginning Initialization	5-8
5.5 Creating a Logical Volume.....	5-10

	Initialization Mode.....	5-10
	Write Policy.....	5-10
	Logical Volume Assignment.....	5-11
5.6	Partitioning a Logical Drive/Logical Volume	5-12
5.7	Mapping a Logical Volume/Logical Drive to Host LUN	5-13
5.8	Assigning Spare Drive and Rebuild Settings	5-14
	Adding a Local Spare Drive.....	5-14
	Adding a Global Spare Drive.....	5-15
	Rebuild Settings	5-15
5.9	Viewing and Editing Logical Drives and Drive Members	5-16
	Deleting a Logical Drive	5-16
	Deleting a Partition of a Logical Drive	5-17
	Assigning a Name to a Logical Drive	5-18
	Rebuilding a Logical Drive.....	5-18
	Regenerating Logical Drive Parity.....	5-19
	Media Scan.....	5-20
	Write Policy.....	5-21
5.10	Viewing and Editing Host LUNs.....	5-22
	Viewing and Deleting LUN Mappings.....	5-22
	Pass-through SCSI Commands	5-22
5.11	Viewing and Editing SCSI Drives.....	5-23
	Scanning a New SCSI Drive	5-23
	Identifying a Drive.....	5-24
	Deleting Spare Drive (Global / Local Spare Drive)	5-25
5.12	Viewing and Editing SCSI Channels	5-25
	Redefining Channel Mode.....	5-25
	Setting a SCSI Channel's ID - Host Channel	5-26
	Viewing IDs.....	5-26
	Adding a Channel ID	5-26
	Deleting a Channel ID	5-27
	Setting a SCSI Channel's Primary ID - Drive Channel	5-27
	Setting a SCSI Channel's Secondary ID - Drive Channel.....	5-28
	Setting the Channel Bus Terminator	5-28
	Setting Transfer Speed	5-29
	Setting Transfer Width.....	5-30
	Viewing and Editing a SCSI Target - Drive Channel.....	5-31
	Slot Number.....	5-31
	Maximum Synchronous Transfer Clock	5-31
	Maximum Transfer Width	5-32
	Parity Check	5-32
	Disconnecting Support	5-32
	Maximum Tag Count	5-33
	Restore to Default Setting	5-33
	Data Rate	5-33
	Issue LIP.....	5-35
5.13	System Functions.....	5-36
	Mute Beeper	5-36
	Change Password	5-36
	Changing Password	5-37
	Disabling Password.....	5-37
	Reset Controller.....	5-37
	Shutdown Controller.....	5-38
	Controller Maintenance	5-38
	Saving NVRAM to Disks.....	5-38
	Restore NVRAM from Disks.....	5-39

Adjust LCD Contrast	5-39
5.14 Controller Parameters	5-40
Controller Name.....	5-40
LCD Title Display Controller Name.....	5-40
Password Validation Timeout	5-40
Controller Unique Identifier	5-40
Controller Date and Time.....	5-41
Time Zone.....	5-41
Date and Time	5-42
5.15 SCSI Drive Utilities.....	5-43
SCSI Drive Low-level Format	5-43
SCSI Drive Read/Write Test.....	5-44

Chapter 6: Terminal Screen Messages

6.1 The Initial Screen	6-1
6.2 Main Menu	6-2
6.3 Quick Installation	6-2
6.4 Logical Drive Status	6-4
6.5 Logical Volume Status	6-5
6.6 SCSI Drive Status.....	6-6
6.7 SCSI Channel's Status	6-7
6.8 Controller Voltage and Temperature	6-9
Controller voltage and temperature monitoring	6-9
6.9 Viewing Event Logs on the Screen.....	6-10

Chapter 7: Terminal Operation

7.1 Power on RAID Enclosure	7-1
7.2 Caching Parameters	7-1
Optimization Modes	7-1
Optimization Mode and Stripe Size	7-3
Optimization for Random or Sequential I/O.....	7-3
Write-Back/Write-Through Cache Enable/Disable	7-4
Periodic Cache Flush.....	7-4
Adaptive Write Policy.....	7-5
7.3 Viewing the Connected Drives	7-6
7.4 Creating a Logical Drive.....	7-7
Choosing a RAID Level:	7-7
Choosing Member Drives:	7-8
Logical Drive Preferences.....	7-8
Maximum Drive Capacity:.....	7-8
Assign Spare Drives	7-8
Disk Reserved Space	7-9
Logical Drive Assignments:	7-9
Write Policy	7-9
Initialization Mode	7-9
Stripe Size.....	7-10
7.5 Creating a Logical Volume.....	7-11
7.6 Partitioning a Logical Drive/Logical Volume	7-13
7.7 Mapping a Logical Volume to Host LUNs	7-15
7.8 Assigning Spare Drive, Rebuild Settings.....	7-17
Adding Local Spare Drive	7-17
Adding a Global Spare Drive	7-18
7.9 Viewing and Editing Logical Drive and Drive Members	7-18

	Deleting a Logical Drive	7-19
	Deleting a Partition of a Logical Drive	7-19
	Assigning a Name to a Logical Drive	7-19
	Rebuilding a Logical Drive.....	7-20
	Regenerating Logical Drive Parity.....	7-21
	(Applies to RAID Levels 1, 3, and 5)	7-21
	Media Scan.....	7-21
	Write Policy.....	7-22
7.10	Viewing and Editing Host LUNs.....	7-23
	Viewing or Deleting LUN Mappings	7-23
	Edit Host-ID/WWN Name List	7-23
	Pass-through SCSI Commands	7-23
7.11	Viewing and Editing Drives	7-24
	Scanning New Drive.....	7-25
	Slot Number.....	7-25
	Drive Entry.....	7-25
	Identifying Drive.....	7-25
	Deleting Spare Drive (Global / Local Spare Drive)	7-26
7.12	Viewing and Editing Channels.....	7-27
	Redefining Channel Mode.....	7-27
	Viewing and Editing SCSI IDs - Host Channel.....	7-28
	Viewing and Editing SCSI IDs	7-28
	Adding an ID (Primary/Secondary Controller ID)	7-28
	Deleting an ID.....	7-29
	Setting a Primary Controller's ID - Drive Channel.....	7-29
	Setting a Secondary Controller's ID - Drive Channel.....	7-30
	Setting Channel Terminator	7-30
	Setting a Transfer Speed	7-31
	Drive Channel.....	7-31
	Setting the Transfer Width.....	7-31
	Viewing and Editing SCSI Target / Drive Channel.....	7-32
	Slot Number.....	7-33
	Maximum Synchronous Transfer Clock	7-33
	Maximum Transfer Width	7-33
	Parity Check	7-34
	Disconnecting Support	7-34
	Maximum Tag Count	7-34
	Data Rate	7-35
	Issue LIP.....	7-35
7.13	System Functions.....	7-37
	Mute Beeper	7-37
	Change Password	7-37
	Changing the Password	7-38
	Setting a New Password	7-38
	Disabling the Password.....	7-39
	Reset Controller.....	7-39
	Shutdown Controller.....	7-39
	Adjust LCD Contrast.....	7-40
7.14	Controller Parameters.....	7-40
	Controller Name	7-40
	LCD Title Display - Controller Name	7-41
	Saving NVRAM to Disks.....	7-41
	Restore NVRAM from Disks.....	7-42
	Password Validation Timeout.....	7-42
	Controller Unique Identifier.....	7-43

Set Controller Date and Time	7-44
Time Zone	7-44
Date and Time	7-44
7.15 Drive Information	7-45
View Drive Information.....	7-45
SCSI Drive Utilities	7-45
SCSI Drive Low-level Format	7-46
SCSI Drive Read/Write Test.....	7-47

Chapter 8: Fibre Operation

8.1 Overview	8-1
8.2 Major Concerns.....	8-2
8.3 Supported Features.....	8-4
Fibre Chip	8-4
Multiple Target IDs:.....	8-4
Drive IDs:	8-5
In-band Fibre and S.E.S. Support:	8-5
8.4 Configuration: Host and Drive Parameters.....	8-6
Channel Mode:	8-6
Primary and Secondary Controller IDs:	8-6
Redundant Controller Cache Coherency Channel (RCC Channel):	8-7
View Channel WWN	8-7
View Device Port Name List (WWPN).....	8-8
View and Edit Fibre Drive	8-8
User-Assigned ID (Scan SCSI Drive).....	8-8
View Drive Information.....	8-9
View and Edit Host-Side Parameters	8-9
1. Fibre Channel Connection Option:.....	8-10
View and Edit Drive-Side Parameters	8-10
2. Drive-Side Dual Loop:	8-10
Controller Unique Identifier	8-11
Controller Communications over Fibre Loops	8-12
8.5 Multi-Host Access Control: LUN Filtering.....	8-14
Creating LUN Masks.....	8-15
WWN Name List	8-16
Logical Unit to Host LUN Mapping	8-16
LUN Mask (ID Range) Configuration:.....	8-18
Filter Type: Include or Exclude	8-19
Access Mode: Read Only or Read/Write.....	8-19
Sample Configuration:	8-20
Configuration Procedure:.....	8-21

Chapter 9: Host Side and Drive Side Parameters

9.1 Host-Side Parameters	9-1
Foreword: SCSI Channel, SCSI ID, and LUN	9-1
Maximum Concurrent Host LUN Connection (“Nexus” in SCSI):.....	9-2
Number of Tags Reserved for each Host-LUN Connection:	9-2
Maximum Queued I/O Count:	9-3
LUNs per Host SCSI ID	9-4
LUN Applicability:.....	9-4
Peripheral Device Type:	9-4
In-band (SCSI or Fibre):	9-5
Peripheral Device Type Parameters for Various Operating Systems:	9-5

	Cylinder/Head/Sector Mapping:	9-7
9.2	Drive-Side Parameters:.....	9-9
	SCSI Motor Spin-Up	9-9
	Disk Access Delay Time.....	9-10
	Drive I/O Timeout	9-10
	Maximum Tag Count (Tag Command Queuing).....	9-11

Chapter 10: Enclosure Management

10.1	Enclosure Monitoring	10-1
	10.1.1 Enclosure Devices.....	10-1
	SAF-TE and SES Enclosure Monitoring	10-1
	(Periodic SAF-TE and SES Device Check Time).....	10-1
	Enclosure Devices Status: View Peripheral Device Status.....	10-2
	Event Triggered Operations	10-3
	The Operations.....	10-3
	The Trigger	10-3
	Dynamic Caching Mode Switch.....	10-5
	Controller Auto-Shutdown - Event Triggered Operations	10-5
	10.1.2 Controller Self-monitoring.....	10-5
	Changing Monitoring Thresholds	10-6
10.2	UPS Support	10-7

Chapter 11: Data Integrity

11.1	Protections against Hardware Faults.....	11-2
	Event Triggered Operations	11-2
	The Operations.....	11-2
	The Trigger	11-2
	Auto Shutdown: Elevated Temperature	11-3
11.2	Maintenance.....	11-5
	11.2.1 Failed Drive Detection	11-5
	Detection of Drive Hot Swap Followed by Auto Rebuild	11-5
	(Periodic Auto-Detect Failure Drive Swap Check Time)	11-5
	Periodic Drive Check Time.....	11-6
	Idle Drive Failure Detection	11-6
	Periodic Auto-Detect Failure Drive Swap Check Time	11-6
	Auto-Assign Global Spare Drive.....	11-7
	11.2.2 Scheduled Maintenance.....	11-8
	Task Scheduler.....	11-8
	Creating a New Schedule.....	11-9
	Adding or Deleting a Schedule.....	11-9
	Task Scheduler Options	11-9
	Execute on Controller Initialization	11-9
	Start Time and Date	11-10
	Execution Period	11-10
	Media Scan Mode.....	11-10
	Media Scan Priority	11-11
	Select Logical Drives	11-11
	Confirming the Creation of a Task Schedule	11-12
	11.2.3 Regenerating Logical Drive Parity.....	11-12
	Overwrite Inconsistent Parity.....	11-12
	Generate Check Parity Error Event.....	11-13
	11.2.4 Disk Array Parameters	11-14
	Rebuild Priority	11-15

Verification on Writes	11-15
------------------------------	-------

Chapter 12: Redundant Controller

12.1 Operation Theory	12-1
12.1.1 Considerations Related to Physical Connection	12-2
Using SCSI-based Controllers.....	12-2
Using Fibre-based Controllers.....	12-3
12.1.2 Grouping Hard Drives and LUN Mapping.....	12-4
Logical Drive, Logical Volume, and Logical Partitions.....	12-5
System Drive Mapping.....	12-7
Primary and Secondary IDs.....	12-7
Mapping	12-7
12.1.3 Fault Tolerance	12-9
What Is a Redundant Controller Configuration?.....	12-9
How does Failover and Failback Work?	12-9
A. Channel Bus	12-9
B. Controller Failover and Failback.....	12-11
Replacing a Failed Unit:.....	12-11
Firmware Synchronization	12-11
Rolling Firmware Upgrade	12-12
C. Active-to-Active Configuration:	12-12
D. Traffic Distribution.....	12-12
E. Controller Failure	12-14
Symptoms	12-14
Connection.....	12-14
12.2 Preparing Controllers.....	12-15
12.2.1 Requirements	12-15
Cabling Requirements	12-15
Controller Settings: General Procedure.....	12-16
12.2.2 Limitations.....	12-17
12.2.3 Configurable Parameters.....	12-17
Primary or Secondary	12-17
Active-to-Active Configuration	12-18
Active-to-Standby Configuration	12-18
Cache Synchronization.....	12-18
Battery Support.....	12-18
12.3 Configuration	12-19
12.3.1 Setup Flowchart.....	12-20
12.3.2 Via Front Panel Keypad.....	12-20
Redundant Configuration Using Automatic Setting	12-20
1. Enable Redundant Controller	12-20
Autoconfig.....	12-21
2. Controller Unique ID.....	12-21
Redundant Configuration Using Manual Setting	12-21
1. Enable Redundant Controller	12-22
2. Controller Unique ID	12-22
Starting the Redundant Controllers	12-23
Creating Primary and Secondary ID.....	12-23
Drive Channel	12-23
Host Channel	12-23
Assigning a Logical Drive/Logical Volume to the Secondary Controller ...	12-24
Mapping a Logical Drive/Logical Volume to the Host LUNs.....	12-25
Front Panel View of Controller Failure.....	12-26
When and how is the failed controller replaced?.....	12-26

12.3.3 Via Terminal Emulation	12-27
Redundant Configuration Using Automatic Setting.....	12-27
Redundant Configuration Using Manual Setting.....	12-28
Creating Primary and Secondary ID	12-30
Assigning Logical Drives to the Secondary Controller.....	12-30
Mapping a Logical Drive/Logical Volume to the Host LUNs	12-31
Terminal Interface View of Controller Failure.....	12-32
What will happen when one of the controllers fails?	12-32
12.3.4 When and How Is the Failed Controller Replaced?.....	12-32
Forcing Controller Failover for Testing.....	12-34
RCC Status (Redundant Controller Communications Channel)	12-35
Secondary Controller RS-232	12-35
Remote Redundant Controller.....	12-35
Cache Synchronization on Write-Through	12-36

Chapter 13: Record of Settings

13.1 View and Edit Logical Drives	13-1
Logical Drive Information.....	13-1
Partition Information	13-2
13.2 View and Edit Logical Volumes	13-3
Logical Volume Information.....	13-3
Partition Information	13-3
13.3 View and Edit Host LUN's.....	13-4
LUN Mappings.....	13-4
Host-ID/WWN Name List.....	13-4
13.4 View and Edit SCSI Drives.....	13-6
13.5 View and Edit SCSI Channels	13-7
13.6 View and Edit Configuration Parameters.....	13-8
Communication Parameters.....	13-8
Ethernet Configuration	13-8
PPP Configuration	13-8
Caching Parameters.....	13-9
Host Side SCSI Parameters.....	13-9
Drive Side SCSI Parameters.....	13-9
Disk Array Parameters	13-10
Redundant Controller Parameters	13-10
Controller Parameters	13-10
13.7 View and Edit Peripheral Devices.....	13-11
Set Peripheral Device Entry	13-11
Event Trigger Options	13-11
Define Peripheral Device Active Signal.....	13-11
View System Information.....	13-11
13.8 Save NVRAM to Disk, Restore from Disk.....	13-12
13.9 RAID Security: Password	13-13
RAID Security	13-13

Chapter 14: Array Expansion

14.1 Overview.....	14-1
14.2 Mode 1 Expansion:.....	14-4
Adding Drives to a Logical Drive	14-4
Add Drive Procedure	14-4
14.3 Mode 2 Expansion:.....	14-7
Copy and Replace Drives with Drives of Larger Capacity	14-7

Copy and Replace Procedure	14-7
14.4 Making Use of the Added Capacity: Expand Logical Drive.....	14-9
14.5 Expand Logical Volume	14-11
14.6 Configuration Example: Volume Extension in Windows 2000®	14-12
Limitations When Using Windows 2000	14-12
Example	14-12

Chapter 15: S.M.A.R.T. Configuration

15.1 Overview	15-1
S.M.A.R.T.	15-1
15.1.1 Clone Failing Drive	15-1
Replace after Clone	15-2
Perpetual Clone:	15-3
15.1.2 S.M.A.R.T. (Self-Monitoring, Analysis and Reporting Technology)	15-5
15.2 Configuration Procedure	15-7
Enabling the S.M.A.R.T. Feature.....	15-7
Examining Whether Your Drives Support S.M.A.R.T.	15-8
Using S.M.A.R.T. Functions	15-9

Chapter 16: Implementations for AV Applications

Maximum Drive Response Time	16-1
-----------------------------------	------

Appendix A: Firmware Functionality

Basic RAID Management:	A-1
Advanced Features:.....	A-3
Caching Operation:.....	A-5
RAID Expansion:.....	A-6
Fibre Channel Support:	A-7
S.M.A.R.T. Support:	A-8
Redundant Controller:.....	A-8
Data Safety:	A-9
System Security:	A-10
Environment Management:.....	A-11
SAF-TE/S.E.S. support	A-11
User Interface:	A-12
RAIDWatch on-board.....	A-12
RS-232C terminal	A-12
High Availability:	A-12
JBOD-Specific:	A-13
Others:	A-13

Appendix B: System Functions: Upgrading Firmware

Upgrading Firmware.....	B-1
New Features Supported with Firmware 3.21	B-1
Background RS-232C Firmware Download:	B-1
Redundant Controller Rolling Firmware Upgrade:	B-1
Redundant Controller Firmware Sync-version:	B-2
Upgrading Firmware Using In-band SCSI + RAIDWatch Manager	B-2
Establish the In-band SCSI connection in RAIDWatch Manager	B-2
Upgrade Both Boot Record and Firmware Binaries	B-3
Upgrade the Firmware Binary Only	B-4

Upgrading Firmware Using RS-232C Terminal Emulation	B-4
Establishing the connection for the RS-232C Terminal Emulation	B-5
Upgrading Both Boot Record and Firmware Binaries	B-5
Upgrading the Firmware Binary Only	B-6

Appendix C: Event Messages

Functional Table of Contents

This functional table of contents helps you to quickly locate the descriptions of firmware functions.

Chapter 1	Functional Description	Page Number
1.4.2	Identifying Drives	1-8
	Flash Selected SCSI Drive	1-8
	Flash All SCSI Drives	1-8
	Flash All But Selected Drives	1-8
1.4.3	Automatic Rebuild and Manual Rebuild	1-9
	Automatic Rebuild	1-9
	Manual Rebuild	1-10
1.4.4	Concurrent Rebuild in RAID (0+1)	1-11

Chapter 3	Out-of-Band via Serial Port and Ethernet	Page Number
	Communication Parameters: Configuring RS-232 Connection	3-1
	Configuring Serial Port via Front Panel	3-2
	Configuring Ethernet TCP/IP	3-5
	Secure link over SSH	3-7

Chapter 4	LCD Screen Messages	Page Number
	View and Edit Event Logs	4-7

Chapter 5 / Chapter 7	Starting RAID via the LCD Panel/Terminal Emulation	Page Number: LCD/ Terminal
	Starting RAID Configuration	
5.2/7.2	Caching Parameters	5-1/7-1
	Optimization Mode and Stripe Size	5-2/7-3
	Optimization for Sequential or Random I/O	5-3/7-3
	Write-Back/Write-Through Cache Enable/Disable	5-3/7-4
	Periodic Cache Flush	7-4
	Adaptive Write Policy	7-5
5.3/7.3	Viewing Connected Drives	5-5/7-6

5.4/7.4	Creating a Logical Drive	5-6/7-7
	Choosing a RAID Level	5-6/7-7
	Choosing Member Drives	5-6/7-8
	Maximum Drive Capacity	5-7/7-8
	Spare Drive Assignments	5-7/7-8
	Logical Drive Assignments	7-9
	Disk Reserved Space	5-7/7-9
	Write Policy	5-7/7-9
	Initialization Mode	5-8/7-9
	Stripe Size	5-8/7-10
	Beginning Initialization	5-8
5.5/7.5	Creating a Logical Volume	5-10/7-11
	Initialization Mode	5-10/7-11
	Write Policy	5-10/7-11
	Logical Volume Assignment	5-11/7-11
5.6/7.6	Partitioning a Logical Drive/Logical Volume	5-12/7-13
5.7/7.7	Mapping a Logical Drive/Logical Volume to Host LUNs	5-13/7-15
5.8/7.8	Assigning Spare Drive, Rebuild Settings	5-14/7-17
	Adding a Local Spare Drive	5-14/7-17
	Adding Global Spare Drive	5-15/7-18
	(Logical Drive) Rebuild Settings	5-15
5.9/7.9	Viewing and Editing Logical Drives and Drive Members	5-16/7-18
	Deleting a Logical Drive	5-16/7-19
	Deleting a Partition of a Logical Drive	5-17/7-19
	Assigning a Logical Drive Name	5-18/7-19
	Rebuilding a Logical Drive	5-18/7-20
	Regenerating Logical Drive Parity	5-19/7-21
	Media Scan	5-20/7-21
5.10/7.10	Viewing and Editing Host LUNs	5-22/7-23
	Viewing and Deleting LUN Mappings	5-22/7-23
	Pass-through SCSI Commands	5-22/7-23
5.11/7.11	Viewing and Editing SCSI Drives	5-23/7-24
	Scanning a New SCSI Drive	5-23/7-25
	Identifying a Drive	5-24/7-25
	Deleting Spare Drive (Global/Local Spare Drive)	5-25/7-26
5.12/7.12	Viewing and Editing SCSI Channels	5-25/7-27
	Viewing and Re-defining Channel Mode	5-25/7-27
	Setting Channel ID/Host Channel	5-26/7-28
	Viewing Channel IDs	5-26/7-28
	Adding a Channel ID	5-26/7-28
	Deleting a Channel ID	5-27/7-29
	Setting a Channel's Primary ID/Drive Channel	5-27/7-29
	Setting a Channel's Secondary ID/Drive Channel	5-28/7-30
	Setting a SCSI Channel's Terminator	5-28/7-30
	Setting the Transfer Speed	5-29/7-31
	Setting the Transfer Width	5-30/7-31
	Viewing and Editing a SCSI Target/Drive Channel	5-31/7-32
	Slot Number	5-31/7-33
	Maximum Synchronous Transfer Clock	5-31/7-33
	Maximum Transfer Width	5-32/7-33
	Parity Check	5-32/7-34
	Disconnecting Support	5-32/7-34
	Maximum Tag Count	5-33/7-34
	Restoring the Default Setting (SCSI Bus)	5-33
	Data Rate	7-34
Issue LIP	5-35	

5.13/7.13	System Functions	5-36/7-37
	Mute Beeper	5-36/7-37
	Change Password	5-36/7-37
	Disabling the Password	5-37/7-39
	Reset Controller	5-37/7-39
	Shutdown Controller	5-38/7-39
	Saving Configuration Data	
	Saving NVRAM to Disks	5-38/7-41
	Restore NVRAM from Disks	5-39/7-42
	Adjust LCD Contrast	5-39/7-40
5.14/7.14	Controller Parameters	5-40/7-40
	Controller Name	5-40/7-40
	LCD Title Display Controller Name	5-40/7-41
	Time Zone	5-41/7-44
	Date and Time	5-42/7-44
	Setting Password	
	Password Validation Timeout	5-40/7-42
	Controller Unique Identifier	5-40/7-43
5.15/7.15	SCSI Drive Utilities	5-43/7-45
	Low-level Format	5-43/7-46
	Read/Write Test	5-44/7-47

Chapter 8	Fibre Operation	Page Number
8.5	Host and Drive Parameters	8-6
	View and Edit Fibre Channel	8-6
	Channel Mode	8-6
	Primary and Secondary Controller IDs	8-6
	RCC Communications Channel (for Cache Coherency)	8-7
	View Channel WWN	8-7
	View Device Port Name List (WWPN)	8-8
	View and Edit Fibre Drives	8-8
	User-Assigned ID (Scan Fibre Drive)	8-8
	View Drive Information	8-9
	View and Edit Host-side Parameters	8-9
	Fibre Connection Types	8-10
	View and Edit Drive-side Parameters	8-10
	Connecting Drives with Dual Loop	8-10
	Controller Unique Identifier	8-11
	Controller Communications over Fibre Loops	8-12
8.5	Multi-host Access Control: LUN Filtering	8-14
	Creating LUN Masks	8-15
	WWN Name List	8-16
	Logical Unit to Host LUN Mapping	8-16
	LUN Mask (ID Range) Configuration	8-18
	Filter Type: Include or Exclude	8-19
	Access Mode: Read Only or Read/Write	8-19
Configuration Procedure	8-21	

Chapter 9	Host-side and Drive-side Parameters	Page Number
9.1	Host-side Parameters	9-1
	Number of Tags Reserved for each Host-LUN Connection	9-2

	Maximum Queued I/O Count	9-3
	LUNs per Host SCSI ID	9-4
	LUN Applicability	9-4
	Peripheral Device Type	9-4
	In-band SCSI/Fibre	9-5
	Peripheral Device Type for Various Operating Systems	9-5
	Peripheral Device Type Settings	9-5
	Cylinder/Head/Sector Mapping	9-7
9.2	Drive-side Parameters	9-9
	SCSI Motor Spin-up	9-9
	Disk Access Delay Time	9-10
	SCSI I/O Timeout	9-10
	Maximum Tag Count (Tag Command Queuing)	9-11

Chapter 10 Enclosure Management		Page Number
10.1	Enclosure Monitoring	10-1
	SAF-TE and SES Enclosure Monitoring (Periodic SAF-TE and SES Device Check Time)	10-1
	Enclosure Device Status	10-2
	Event Triggered Operations	10-3
	Dynamic Caching Mode Switch	10-5
	Controller Auto-Shutdown	10-5
	Controller Self-Monitoring	10-5
	Changing Monitoring Thresholds	10-6
10.2	UPS Support	10-7

Chapter 11 Data Integrity		Page Number
11.1	Protections against Hardware Faults	11-2
	Event Triggered Operations	11-2
	Auto-Shutdown on Elevated Temperature	11-3
11.2	Maintenance	11-5
	Detection of Drive Hot Swap Followed by Auto Rebuild	11-5
	Periodic Drive Check Time	11-6
	Idle Drive Failure Detection	11-6
	Auto-Assign Global Spare Drive	11-7
	Task Scheduler	11-8
	Task Scheduler Options	11-9
	Regenerating Logical Drive Parity	11-12
	Disk Array Parameters	11-14
	Rebuild Priority	11-15
	Verification on Writes	11-15

Chapter 12 Redundant Controller Configuration		Page Number: LCD/Terminal
12.3	Configuration	12-20
12.3.1	Via Front Panel Keypad	12-20
	Redundant Configuration Using Automatic Setting	12-21
	Redundant Configuration Using Manual Setting	12-22
	Starting the Redundant Controllers	12-23
	Creating Primary and Secondary IDs	12-24
	Assigning a Logical Drive/Logical Volume to the Secondary Controller	12-25

	Mapping a Logical Drive/Logical Volume to the Host LUNs	12-26
	Front Panel View of Controller Failure	12-26
	When and How is the Failed Controller Replaced	12-26
12.3.2	Via Terminal Emulation	12-27
	Redundant Configuration Using Automatic Setting	12-27
	Redundant Configuration Using Manual Setting	12-28
	Creating Primary and Secondary IDs	12-30
	Assigning a Logical Drive/Logical Volume to the Secondary Controller	12-30
	Mapping a Logical Drive/Logical Volume to the Host LUNs	12-31
	Terminal View of Controller Failure	12-32
12.3.4	When and How is the Failed Controller Replaced	12-32
	Forcing Controller Failure for Testing	12-34
	RCC status (RCC channels)	12-35
	Secondary Controller RS-232	12-35
	Remote Redundant Controller	12-36
	Cache Synchronization on Write-Through	12-36

Chapter 14	Array Expansion	Page Number
14.1	RAID Expansion	14-1
14.2	Mode 1 Expansion: Adding Drive to A Logical Drive	14-4
14.3	Mode 2 Expansion: Copy & Replace Drive with Drives of Larger Capacity	14-7
14.4	Expand Logical Drive (Making Use of the Added Capacity)	14-9
14.5	Expand Logical Volume	14-11
14.6	Example: RAID Expansion in Windows 2000	14-12

Chapter 15	S.M.A.R.T. Configurations	Page Number
15.1	Fault Prevention	15-1
	Clone Failing Drive	15-2
	Replace after Clone	15-2
	Perpetual Clone	15-3
15.2	S.M.A.R.T. with Enhanced Features	15-5
	S.M.A.R.T. Features (Enabling S.M.A.R.T.)	15-7
	"Detect Only"	15-7
	"Detect, Perpetual Clone"	15-7
	"Detect, Clone + Replace"	15-8

Chapter 16	Implementations for AV Applications	Page Number
	Maximum Drive Response Time	16-1

Appendix B	Controller Maintenance	Page Number:
	Upgrading Firmware	B-1
	New Features Supported with Firmware 3.21	B-1
	Background RS-232 Firmware Download	B-1

	Redundant Controller Rolling Firmware Download	B-1
	Redundant Controller Firmware Sync-version	B-2
	Upgrading Firmware Using In-band SCSI + RAIDWatch Manager	B-2
	Establish the In-band SCSI Connection in RAIDWatch Manager	B-2
	Upgrade Both Boot Record and Firmware Binaries	B-3
	Upgrade the Firmware Binary Only	B-4
	Upgrading Firmware Using RS-232 Terminal Emulation	B-4
	Establishing the Connection for the RS-232 Terminal Emulation	B-5
	Upgrading Both Boot Record and Firmware Binaries	B-5
	Upgrading the Firmware Binary Only	B-6

List of Tables

Chapter 1

Table 1 - 1 RAID Levels.....	1-2
------------------------------	-----

Chapter 2

Table 2 - 1 RAID Levels.....	2-4
Table 2 - 2 Controller Parameter Settings.....	2-10

Chapter 5

Table 5 - 1 RAID Level, Optimization Modes, and Stripe Size.....	5-8
--	-----

Chapter 7

Table 7 - 1 RAID Levels, Optimization Modes, and Stripe Sizes.....	7-3
--	-----

Chapter 9

Table 9 - 1 Peripheral Device Type Parameters.....	9-6
Table 9 - 2 Peripheral Device Type Settings.....	9-6
Table 9 - 3 Cylinder/Head/Sector Mapping under Sun Solaris.....	9-7

Chapter 12

Table 12 - 1 ID Mapping Status (Normal Operation).....	12-10
Table 12 - 2 ID Mapping Status (Controller Failed).....	12-10

List of Figures

Chapter 1

Figure 1 - 1 Logical Drive	1-1
Figure 1 - 2 NRAID	1-3
Figure 1 - 3 JBOD.....	1-3
Figure 1 - 4 RAID 0.....	1-4
Figure 1 - 5 RAID 1.....	1-4
Figure 1 - 6 RAID (0+1).....	1-4
Figure 1 - 7 RAID 3.....	1-5
Figure 1 - 8 RAID 5.....	1-5
Figure 1 - 9 Local (Dedicated) Spare	1-6
Figure 1 - 10 Global Spare	1-6
Figure 1 - 11 Global Spare Rebuild.....	1-7
Figure 1 - 12 Mixing Local and Global Spares	1-7
Figure 1 - 13 Flash Selected Drive.....	1-8
Figure 1 - 14 Flash All Drives	1-8
Figure 1 - 15 Flash All but Selected Drives	1-8
Figure 1 - 16 Automatic Rebuild.....	1-9
Figure 1 - 17 Manual Rebuild	1-10
Figure 1 - 18 Logical Volume	1-11
Figure 1 - 19 Logical Drive Composed of 24 Drives	1-12
Figure 1 - 20 Logical Volume with 4 Logical Drives	1-13
Figure 1 - 21 Logical Volume with Drives on Different Channels	1-14

Chapter 2

Figure 2 - 1 Optimization Setting.....	2-3
Figure 2 - 2 Array Configuration Process.....	2-5
Figure 2 - 3 SCSI ID/LUNs	2-7
Figure 2 - 4 Connecting Drives.....	2-7
Figure 2 - 5 Physical Locations of Drive Members	2-8
Figure 2 - 6 Partitions in Logical Configurations	2-8
Figure 2 - 7 Mapping Partitions to Host ID/LUNs.....	2-9
Figure 2 - 8 Mapping Partitions to LUNs under ID	2-9

Chapter 5

Figure 5 - 1 Drive Space Allocated to the Last Partition	5-17
Figure 5 - 2 Cabling Failure between Drive Enclosures.....	5-35

Chapter 7

Figure 7 - 1 Drive Space Allocated to the Last Partition	7-19
Figure 7 - 2 Cabling Failure between Drive Enclosures.....	7-36

Chapter 8

Figure 8 - 1 Storage Pool	8-14
Figure 8 - 2 Host-LUN Mapping	8-15
Figure 8 - 3 LUN Mask	8-15
Figure 8 - 4 LUN Filtering - Configuration Sample.....	8-20

Chapter 9

Figure 9 -1 SCSI ID/LUNs	9-1
--------------------------------	-----

Chapter 12

Figure 12 - 1 Dual-controller Setting Using SCSI-Based Controllers.....	12-2
Figure 12 - 2 Dual-controller Setting Using Fibre-based Controllers	12-3
Figure 12 - 3 Grouping Hard Drives	12-6
Figure 12 - 4 Partitioning of Logical Units.....	12-6
Figure 12 - 5 Mapping System Drives (Mapping LUNs).....	12-8
Figure 12 - 6 Mapping System Drives (IDs)	12-8
Figure 12 - 7 Redundant Controller Channel Bus	12-9
Figure 12 - 8 Controller Failover	12-11
Figure 12 - 9 Traffic Distribution	12-13
Figure 12 - 10 Controller Failover	12-14
Figure 12 - 11 Redundant Controller Configuration Flowchart.....	12-20

Chapter 14

Figure 14 - 1 Logical Drive Expansion.....	14-3
Figure 14 - 2 Expansion by Adding Drive	14-4
Figure 14 - 3 Expansion by Copy & Replace.....	14-7

About This Manual

This manual provides all of the necessary information that a system administrator needs to configure and maintain one of Infortrend's external RAID controllers or subsystems. For hardware-related information, please refer to the *Hardware Manual* that came with your RAID controller/subsystem. Also available is the *User's Manual* for the Java-based GUI RAID manager for remote and concurrent management of RAID systems.

The order of the chapters is arranged in accordance with the steps necessary for creating a RAID.

The terminal screen displays and the LCD messages may vary when using subsystems running different firmware versions.

Chapter 1	Introduces basic RAID concepts and configurations, including RAID levels, logical drives, spare drives, and the use of logical volumes. It is recommended that users unfamiliar with RAID technologies should read this chapter before creating a configuration.
Chapter 2	Tells the user how to begin with a RAID. At the beginning of this chapter, we raise some basic questions to which the user should know the answers prior to creating a RAID.
Chapter 3	Teaches the user how to configure the RS-232C terminal emulation interface and the connection through a LAN port.
Chapter 4	Helps the user to understand screen messages on the LCD display.
Chapter 5	Gives step-by-step instructions on creating a RAID using the LCD keypad panel.
Chapter 6	Teaches the user how to interpret the information found on the RS-232 terminal emulation.
Chapter 7	Gives step-by-step instructions on how to create a RAID via the RS-232 session.
Chapter 8	Includes all the Fibre Channel-specific functions implemented since the firmware release 3.12.
Chapter 9	Provides the advanced options for the host and drive channel configurations including I/O queuing, number of LUNs, host loop, in-band, and disk access characteristics settings.
Chapter 10	Shows how to supervise system operating and component status.
Chapter 11	Details various methods, either manual or automatic, for maintaining array data integrity.
Chapter 12	Addresses the concerns regarding the redundant

	controller configuration and the configuration process.
Chapter 13	Provides the recording forms with which a system administrator can keep a record of his configuration.
Chapter 14	Shows how to expand a configured array or logical volume.
Chapter 15	Shows how to use the SMART-related functionality.
Chapter 16	Illustrates the Maximum Response Time setup
Appendix A	Lists the important firmware features supported with the firmware version, arranged in accordance with the latest firmware version as of press date.
Appendix B	Teaches the user how to upgrade firmware and boot record.
Appendix C	Lists all of the controller event messages.

Firmware Version & Other Information

Firmware Version: 3.41 and 3.42

Date: 9/01/04

Revision History:

- Version 1.0:
 - Initial release
- Version 1.1:
 - Added redundant controller configuration
- Version 1.2:
 - Added host-side and drive-side SCSI parameters
 - Added S.M.A.R.T. with implemented fault-prevention methods.
 - Added system functions
 - Added Fault-bus configuration to be compatible with 3101 and 3102 series
 - Added Host-side interface installation details
 - Added Event Messages for error message identification
 - Added all advanced functions available since 2.23K and 3.11F upward
 - Added a functional table of contents for quick searching functions
 - Moved SCSI/Fibre Cable Specifications to Hardware Manual
- Version 1.3:
 - Added Chapter 8 "Fibre Operation" for the new functions available since firmware release 3.12
- Version 1.4:
 - Added firmware features available with firmware revisions 3.14, 3.15, and 3.21
 - Revised details about redundant controllers, host LUN mapping, etc.
 - Modified string definitions in Chapter 14 "In-band SCSI Drives and Utilities" section
 - Corrected descriptions of "Controller Unique Identifier"
 - Added the configuration process for out-of-band configuration via LAN port
- Version 1.5:
 - Removed Chapter 14
 - Revised the descriptions for some functional items
 - Added firmware features available from revision 3.25

- Version 1.61:
- Added features available by revision 3.31
 - Removed Appendix E
 - Moved array expansion to Chapter 12
 - Added variable stripe size, write policy per array
 - Added Media Scan
 - Added controller immediate array availability, time zone, date and time setting
 - Added IO channel diagnostics
 - Added controller auto-shutdown and cache-flush mechanisms
 - Added system monitoring via enclosure modules
 - Added disabling cache coherency using write-through mode
 - Added descriptions about new firmware utility items
 - Added details about enabling RAIDWatch and its sub modules via Ethernet port
- Version 1.62:
- Added functions previously included in controller Hardware Manual
 - Added remote redundant functionality
 - Updated firmware event messages
 - Updated LCD panel navigation map
 - Added Appendix E - Dial-Out Modem
- Version 1.63:
- Added Task Scheduler
 - Added Periodic Cache Flush
 - Added parity regeneration options
 - Added Event Triggered Operations
 - Updated firmware event messages
 - Added new chapters for specific functionality groups
 - Removed Appendix A - LCD Navigation Road Map. The Road Map will be available as print-out copies.
- Version 1.64:
- Added description or configuration procedure for the following:
- Maximum Drive Response Time
 - Host-side 64-bit LBA support
 - Host-side Ordered Tag support
 - Host-side Re-routing support
 - Adaptive Write-back/Write-through switching
 - SSH connection support
 - Issue LIP command
- Version 1.65:
- Corrected functional details.

- Version 1.61:
- Added features available by revision 3.31
 - Removed Appendix E
 - Moved array expansion to Chapter 12
 - Added variable stripe size, write policy per array
 - Added Media Scan
 - Added controller immediate array availability, time zone, date and time setting
 - Added IO channel diagnostics
 - Added controller auto-shutdown and cache-flush mechanisms
 - Added system monitoring via enclosure modules
 - Added disabling cache coherency using write-through mode
 - Added descriptions about new firmware utility items
 - Added details about enabling RAIDWatch and its sub modules via Ethernet port
- Version 1.62:
- Added functions previously included in controller Hardware Manual
 - Added remote redundant functionality
 - Updated firmware event messages
 - Updated LCD panel navigation map
 - Added Appendix E - Dial-Out Modem
- Version 1.63:
- Added Task Scheduler
 - Added Periodic Cache Flush
 - Added parity regeneration options
 - Added Event Triggered Operations
 - Updated firmware event messages
 - Added new chapters for specific functionality groups
 - Removed Appendix A - LCD Navigation Road Map. The Road Map will be available as print-out copies.
- Version 1.64:
- Added description or configuration procedure for the following:
- Maximum Drive Response Time
 - Host-side 64-bit LBA support
 - Host-side Ordered Tag support
 - Host-side Re-routing support
 - Adaptive Write-back/Write-through switching
 - SSH connection support
 - Issue LIP command
- Version 1.65:
- Corrected functional details.

RAID Functions: An Introduction

Redundant Arrays of Independent Disks, or RAID, offers the following advantages: availability, capacity, and performance. Choosing the right RAID level and drive failure management can increase capacity and performance, subsequently increasing availability. Infortrend's external RAID controllers and subsystems provide complete RAID functionality and enhanced drive failure management.

1.1 Logical Drive

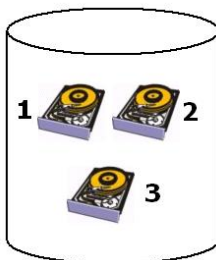

The advantages mentioned above are achieved by creating “logical drives.” A logical drive is an array of independent physical drives. The logical drive appears to the host as a contiguous volume, the same as a local hard disk drive does.

Figure 1 - 1 Logical Drive

The following section describes the different methods to create logical arrays of disk drives, such as spanning, mirroring and data parity. These methods are referred to as “RAID levels.”

1.2 Logical Volume

What is a logical volume?

The concept of a logical volume is very similar to that of a logical drive. A logical volume is the combination of one or several logical drives. These logical drives are combined into a larger capacity using the RAID 0 method (striping). When data is written to a logical volume, it is first broken into data segments and then striped across different logical drives in a logical volume. Each logical drive

then distributes data segments to its member drives according to the specific RAID level it is composed of.

The member logical drives can be composed of the same RAID level or each of a different RAID level. A logical volume can be divided into a maximum of 64 partitions. During operation, the host sees a non-partitioned logical volume or a partition of a logical volume as one single physical drive.

1.3 RAID Levels

Using a RAID storage subsystem has the following advantages:

- Provides disk spanning by weaving all connected drives into one single volume.
- Increases disk access speed by breaking data into several blocks when reading/writing to several drives in parallel. With RAID, storage speed increases as more drives are added as the channel bus allows.
- Provides fault-tolerance by mirroring or parity operation.

What Are the RAID Levels?

Table 1 - 1 RAID Levels

RAID Level	Description	Capacity	Data Availability
NRAID	Non-RAID	N	
RAID 0	Disk Striping	N	==NRAID
RAID 1 (0+1)	Mirroring Plus Striping (if N>1)	N/2	>>NRAID ==RAID 5
RAID 3	Striping with Parity on dedicated disk	N-1	>>NRAID ==RAID 5
RAID 5	Striping with interspersed parity	N-1	>>NRAID ==RAID 5
RAID 10 (Logical Volume)	Striping with RAID 1 logical drives	/	>>NRAID >>RAID 5
RAID 30 (Logical Volume)	Striping with RAID 3 logical drives	/	>>NRAID >>RAID 5
RAID 50 (Logical Volume)	Striping with RAID 5 logical drives	/	>>NRAID >>RAID 5

NOTE: *Drives on different channels can be included in a logical drive and logical drives of different RAID levels can be used to compose a logical volume. There are more combinations than RAID 10, 30, and 50.*

RAID Level	Performance Sequential	Performance Random
NRAID	Drive	Drive
RAID 0	R: Highest W: Highest	R: High W: Highest
RAID 1 (0+1)	R: High W: Medium	R: Medium W: Low
RAID 3	R: High W: Medium	R: Medium W: Low
RAID 5	R: High W: Medium	R: High W: Low

NRAID Disk Spanning

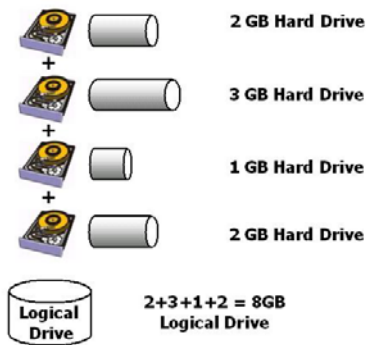

NRAID	
Minimum Disks Required	1
Capacity	N
Redundancy	No

NRAID stands for Non-RAID. The capacity of all drives is combined to become one logical drive (no block striping). In other words, the capacity of the logical drive is the total capacity of the physical member drives. NRAID does not provide data redundancy.

Figure 1 - 2 NRAID

JBOD Single Drive Control

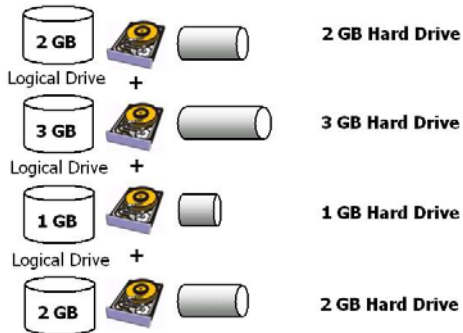

JBOD	
Minimum Disks Required	1
Capacity	1
Redundancy	No

JBOD stands for Just a Bunch of Drives. The controller treats each drive as a stand-alone disk; therefore, each drive is an independent logical drive. JBOD does not provide data redundancy.

Figure 1 - 3 JBOD

RAID 0 Disk Striping

Logical Drive

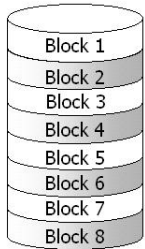

Physical Disks

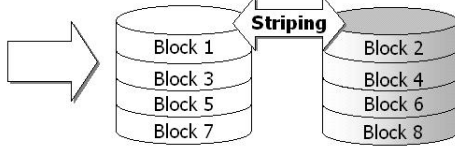

RAID 0	
Minimum Disks Required	2
Capacity	N
Redundancy	No

RAID 0 provides the highest performance but no redundancy. Data in the logical drive is striped (distributed) across several physical drives.

Figure 1 - 4 RAID 0

RAID 1 Disk Mirroring

Logical Drive

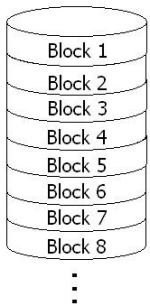

Physical Disks

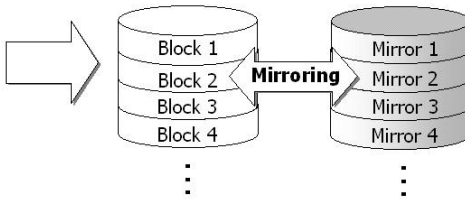

RAID 1	
Minimum Disks Required	2
Capacity	N/2
Redundancy	Yes

RAID 1 mirrors the data stored in one hard drive to another. RAID 1 can only be performed with two hard drives. If there are more than two hard drives, RAID (0+1) will be automatically applied.

Figure 1 - 5 RAID 1

RAID (0+1) Disk Striping with Mirroring

Logical Drive

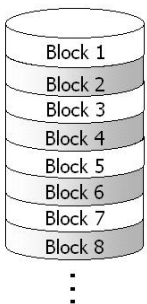

Physical Disks

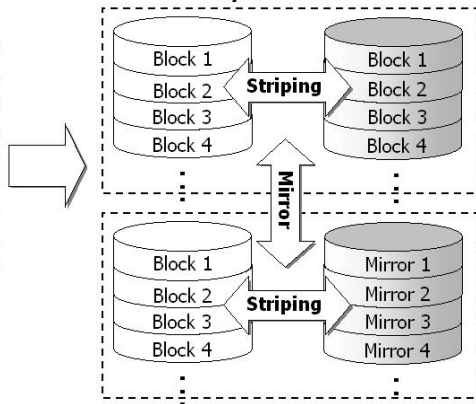

RAID (0+1)	
Minimum Disks Required	4
Capacity	N/2
Redundancy	Yes

RAID (0+1) combines RAID 0 and RAID 1 - Mirroring and Striping. RAID (0+1) allows multiple drive failure because of the full redundancy of the hard drives. If there are more than two hard drives assigned to perform RAID 1, RAID (0+1) will be automatically applied.

Figure 1 - 6 RAID (0+1)

IMPORTANT!

“RAID (0+1)” will not appear in the list of RAID levels supported by the controller. If you wish to perform RAID 1, the controller will determine whether to perform RAID 1 or RAID (0+1). This will depend on the number of drives that have been selected for the logical drive.

RAID 3

Disk Striping
with Dedicated Parity Disk

RAID (0+1)	
Minimum Disks Required	3
Capacity	N-1
Redundancy	Yes

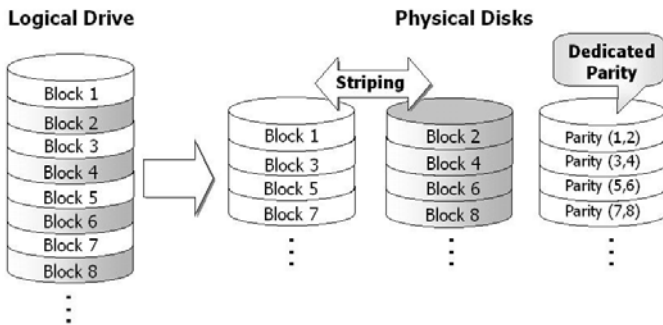

RAID 3 performs Block Striping with Dedicated Parity. One drive member is dedicated to storing the parity data. When a drive member fails, the controller can recover/regenerate the lost data of the failed drive by comparing and recalculating data on the remaining drives.

Figure 1 - 7 RAID 3

RAID 5

Striping with Interspersed Parity

RAID 5	
Minimum Disks Required	3
Capacity	N-1
Redundancy	Yes

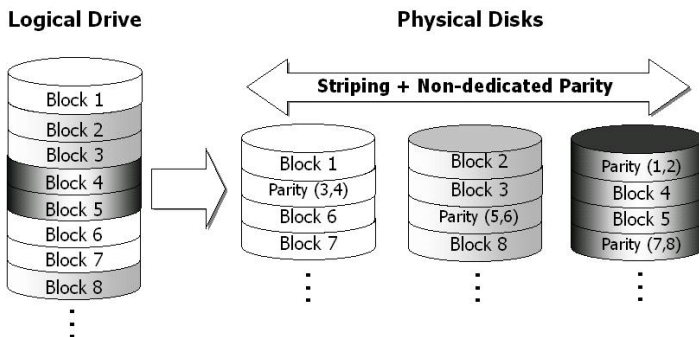

Figure 1 - 8 RAID 5

RAID 5 is similar to RAID 3 but the parity data is not stored in a dedicated hard drive. Parity information is interspersed across the drive array. In the event of a drive failure, the controller can recover/regenerate the lost data of the failed drive by comparing and re-calculating data on the remaining drives.

RAID 10, RAID 30, and RAID 50 are implemented as logical volumes; please refer to the proceeding discussions for details.

1.4 Spare Drives

Global and Local Spare Drives

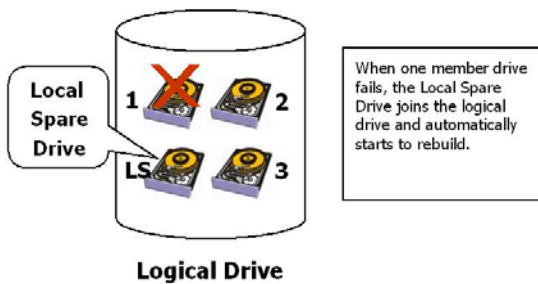

A Local Spare Drive is a standby drive assigned to serve one specified logical drive. When a member drive of this specified logical drive fails, the Local Spare Drive becomes a member drive and automatically starts to rebuild.

Figure 1 - 9 Local (Dedicated) Spare

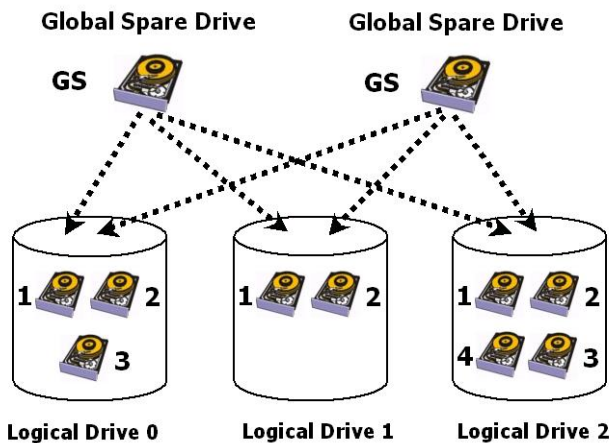

A Global Spare Drive serves more than one specified logical drive. When a member drive from any of the logical drives fails, the Global Spare Drive will join that logical drive and automatically start to rebuild.

Figure 1 - 10 Global Spare

Global Spare Drives serve any logical drive.

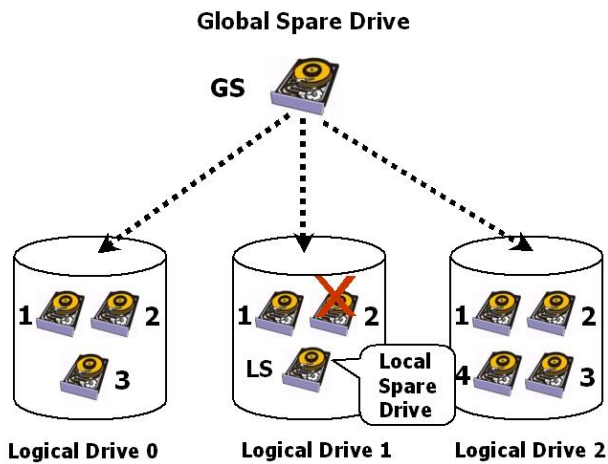

The example on the left provides both Local Spare Drive and Global Spare Drive functions. On certain occasions, applying these two functions together will better fit various needs. Take note that the **Local Spare Drive always has higher priority than the Global Spare Drive.**

Figure 1 - 11 Global Spare Rebuild

When a member drive from any logical drive fails, the Global Spare Drive joins that logical drive and automatically starts to rebuild.

In the example shown below, the members of Logical Drive 0 are 9GB drives, and the members in Logical Drives 1 and 2 are 4GB drives.

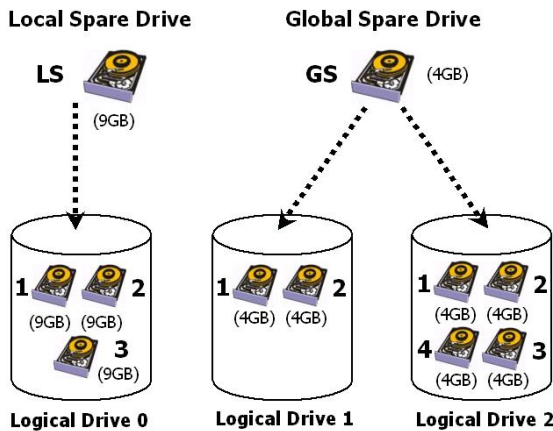

It is not possible for the 4GB Global Spare Drive to join Logical Drive 0 because of its insufficient capacity. However, using a 9GB drive as the Global Spare Drive for a failed drive that comes from Logical Drive 1 or 2 will bring a huge amount of excess capacity since these logical drives require 4GB only. As shown on the left, the 9GB Local Spare will aid Logical Drive 0 once a drive in this logical drive fails. If the failed drive is in Logical Drive 1 or 2, the 4GB Global Spare drive will immediately give aid to the failed drive.

A Local Spare always has higher priority than a Global Spare.

4GB Global Spare drive will immediately give aid to the failed drive.

Figure 1 - 12 Mixing Local and Global Spares

1.5 Identifying Drives

Whenever there is a failed drive in the RAID 5 logical drive, make it a point to replace the failed drive with a new, healthy drive to keep the logical drive working.

If you replaced the wrong drive when trying to replace a failed drive you will no longer be able to access the logical drive because you have inadvertently failed another drive.

To prevent this from happening, the controller provides an easy way to identify the faulty drive. By forcing certain drive LEDs to light for a configurable period of time, the faulty drive can be identified, and thus reduce the chance of removing the wrong drive. This function can be especially helpful in an installation site operating with hundreds of drives.

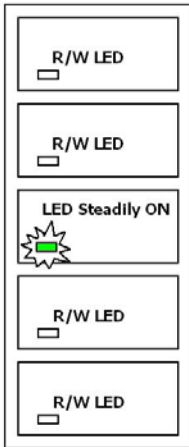

Flash Selected Drive

The Read/Write LED of the drive you selected will light steadily for a configurable period of time, from 1 to 999 seconds.

Figure 1 - 13 Flash Selected Drive

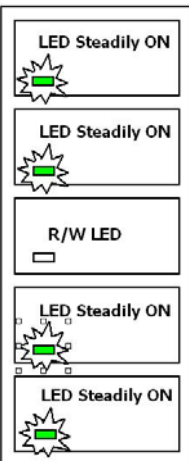

Flash All Drives

The Read/Write LEDs of all connected drives will light for a configurable period of time. If the LED of the defective drive did not light on the “Flash Selected SCSI Drive” function, use “Flash All SCSI Drives” to verify the fault. If the “Flash All SCSI Drives” function is executed, and the defective drive’s LED still does not respond, it can be a drive tray problem or the drive is dead.

Figure 1 - 14 Flash All Drives

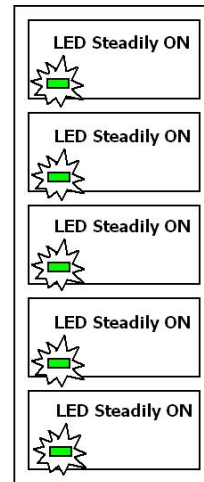

Flash All but Selected Drives

Except the selected drive, the Read/Write LEDs of all connected drives will light for a configurable period of time ranging from 1 to 999 seconds. If an administrator cannot be sure of the exact location of a specific drive, this function will help to indicate where it is. This can prevent removal of the wrong drive when a drive fails and is about to be replaced.

Figure 1 - 15 Flash All but Selected Drives

The drive-identifying function can be selected from "Main Menu"/"View and Edit SCSI Drives"/"Identify SCSI Drives."

1.6 Rebuild

Automatic Rebuild and Manual Rebuild

1. Automatic Rebuild

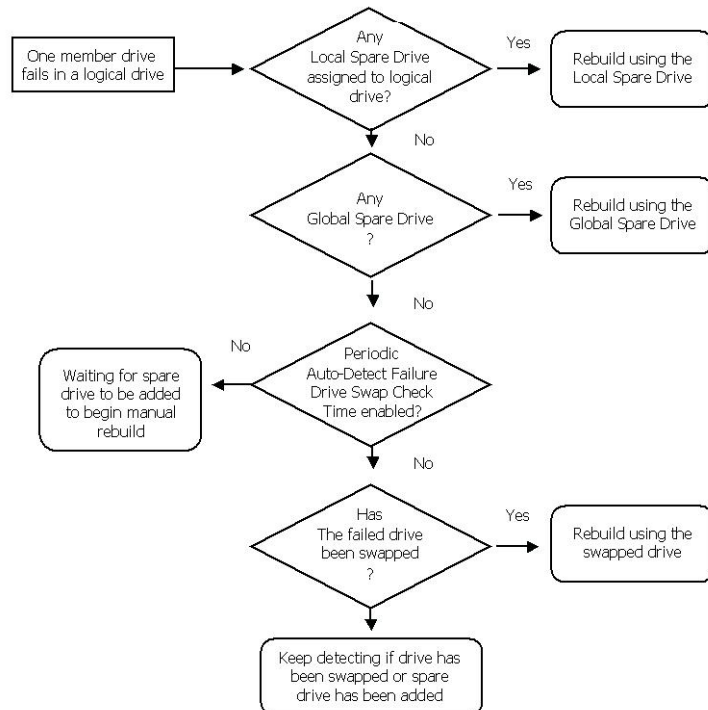

Figure 1 - 16 Automatic Rebuild

Rebuild with Spare: When a member drive in a logical drive fails, the controller will first examine whether there is a Local Spare Drive assigned to this logical drive. If yes, rebuild is automatically started.

If there is no Local Spare available, the controller will search for a Global Spare. If there is a Global Spare, rebuild automatically begins using the Global Spare.

Failed Drive Swap Detected: If neither a Local Spare Drive nor Global Spare Drive is available, and the "*Periodic Auto-Detect Failure Drive Swap Check Time*" is "Disabled," the controller will not attempt to rebuild unless the user applies a forced-manual rebuild.

When the "*Periodic Auto-Detect Failure Drive Swap Check Time*" is "Enabled" (i.e., a check time interval has been selected), the controller will detect whether a faulty drive has been swapped (by checking the failed drive's channel/ID). Once the failed drive has been replaced with a healthy drive, the rebuild will begin immediately.

If the failed drive is not swapped but a local spare is added to the logical drive, rebuild will begin with the spare.

If the S.M.A.R.T. function is enabled on drives and the reaction scheme is selected for securing data on a failing drive, the spare will also be used for restoring data. Please refer to *Chapter 9, Advanced Functions*, for more details.

2. Manual Rebuild

When a user applies a forced-manual rebuild, the controller will first examine whether there is any Local Spare assigned to the logical drive. If yes, it will automatically start to rebuild.

If there is no Local Spare available, the controller will search for a Global Spare. If there is a Global Spare, logical drive rebuild will be automatically conducted.

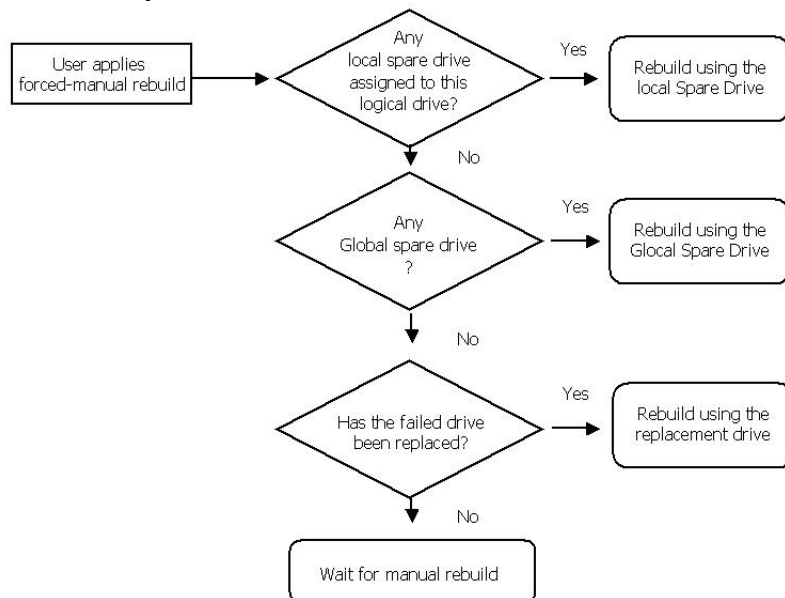

Figure 1 - 17 Manual Rebuild

If none of the spares are available, the controller will examine the SCSI channel and ID of the failed drive. Once the failed drive has been replaced by a healthy one, it starts to rebuild using the new drive. If there is no available drive for rebuilding, the controller will

not attempt to rebuild until the user applies another forced-manual rebuild.

3. Concurrent Rebuild in RAID (0+1)

RAID (0+1) allows multiple drive failures and rebuilds to be concurrently conducted on more than one of its members. Drives newly swapped must be scanned and set as Local Spares. These drives will be used for rebuilding at the same time - you do not need to repeat the rebuild process for each member drive.

1.7 Logical Volume (Multi-Level RAID)

What Is a Logical Volume?

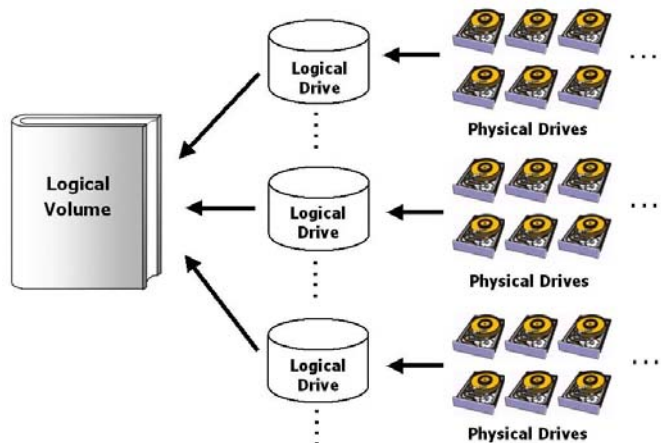

Figure 1 - 18 Logical Volume

A logical volume is a combination of RAID 0 (Striping) and other RAID levels. Data written to a logical volume is first broken into smaller data segments and striped across different logical drives in a logical volume. Each logical drive then distributes data segments to its member drives according to its mirroring, parity, or striping scheme. A logical volume can be divided into a maximum of eight partitions. During normal operation, the host sees a non-partitioned logical volume or a partition of a partitioned logical volume as one single physical drive.

The benefits of using a logical volume are achieved by:

1. Extending the MTBF (mean time between failure) by using more redundancy drives (spare drives).

2. Decreasing the time to rebuild and reducing the chance of data loss caused by simultaneous drive failures because drives are included in different drive groups using a multi-level logical structure.
3. Avoiding the chance of data loss caused by channel bus failure with flexible drive deployment.

As diagramed below, numerous drives can be included in a logical drive, and one of them is used for redundancy. By grouping these drives into several logical drives, and then into a logical volume, the chance of two drives failing in a logical unit is greatly reduced. Each logical drive can have one or more local spares. A failed drive can be immediately replaced by a local spare, reducing the risk of losing data if another drive fails soon afterwards.

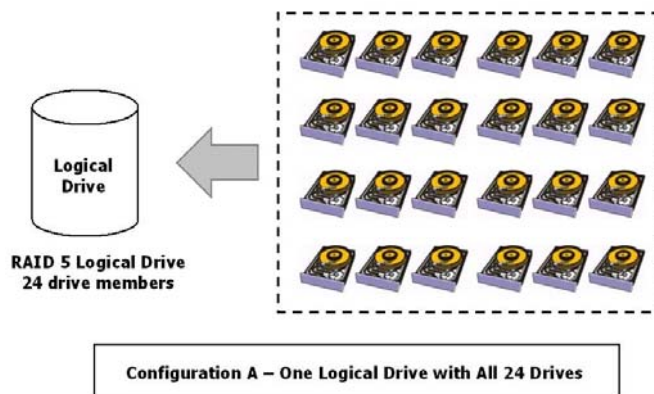

Figure 1 - 19 Logical Drive Composed of 24 Drives

As illustrated above, Configuration A is a RAID 5 logical drive consisting of 24 physical drives. Configuration B is a logical volume made of four RAID 5 logical drives.

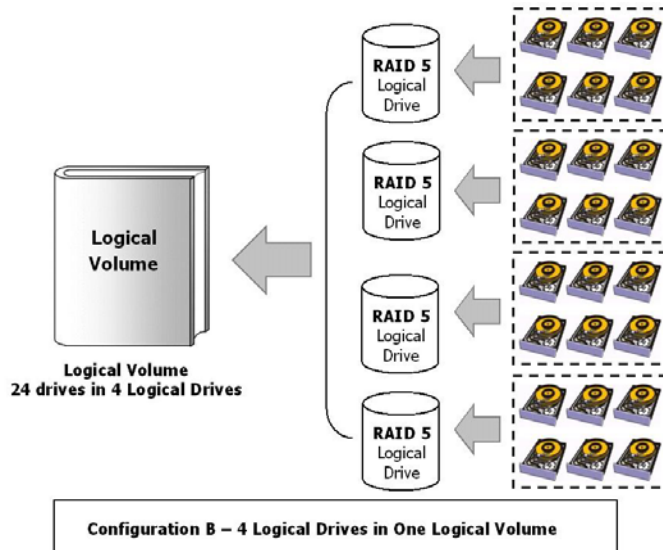

Figure 1 - 20 Logical Volume with 4 Logical Drives

Configuration B can help reduce the chance of encountering points of failure:

a) Higher Redundancy: Configuration A has one dedicated spare, while Configuration B allows the configuration of four spares. In Configuration B, the risk of simultaneous drive failure in a logical drive is significantly reduced compared to Configuration A. The total array capacity is comparatively smaller by the use of spares.

b) Less Rebuild Time: The time during rebuild is a time of potential hazard. For example, a RAID 5 logical drive can only withstand single drive failure - if another drive fails during the rebuild process, data will be lost. The time span for rebuilding a faulty drive should be minimized to reduce the possibility of having two drives fail at the same time.

Configuration A is a large logical drive and takes a long time to rebuild. All members will be involved during the rebuild process. In Configuration B, the time span is shorter because only six members will participate when rebuilding any of the logical drives.

c) Channel Failure Protection: Channel failure may sometimes result from unlikely matters such as a cable failure. A channel failure will cause multiple drives to fail at the same time and inevitably lead to a fatal failure. Using a logical volume with drives coming from different drive channels can avoid this point of failure.

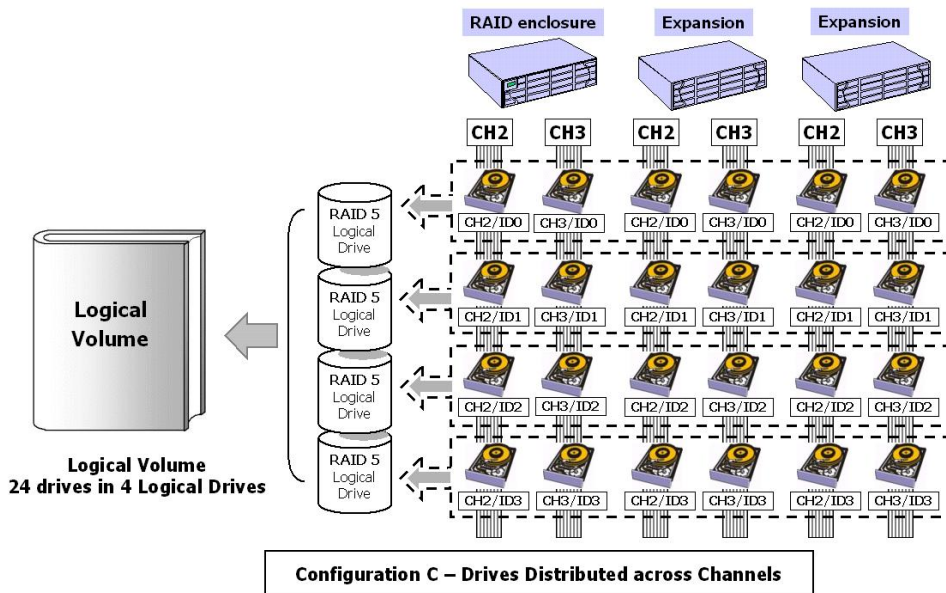

Figure 1 - 21 Logical Volume with Drives on Different Channels

As illustrated above, if one of the drive channels fails, each logical drive loses one of its members. Logical drives still have the chance to rebuild its members. Data remains intact and the rebuild can be performed after the failed channel is recovered. No access interruptions to the logical volume will be experienced from the host side.

Spare Drives Assigned to a Logical Volume?

A Local Spare cannot be assigned to a Logical Volume. If a drive fails, it fails as a member of a logical drive; therefore, the controller allows a Local Spare's assignment to logical drives rather than logical volumes.

Limitations:

The logical volume can not have any logical drive stated as "fatal failed." If there is any failed drive in any of its member logical drives, the controller will start to rebuild that logical drive. If any of the member logical drives fail fatally, the logical volume fails fatally and data will not be accessible.

To avoid a logical volume failure:

1. Logical drives as members of a logical volume should be configured in RAID levels that provide redundancy, i.e., - RAID levels 1 (0+1), 3, or 5.

2. Rebuild the logical drive as soon as possible whenever a drive failure occurs. Use of local spares is recommended.
3. A logical drive should be composed of physical drives from different drive channels. Compose the logical drive with drives from different drive channels to avoid the fatal loss of data caused by bus failure.

Partitioning the Logical Drive or Partitioning the Logical Volume?

Once a logical drive has been divided into partitions, the logical drive can no longer be used as a member of a logical volume. The members of a logical volume should have one partition only with the entire capacity.

If you want to use a partitioned logical drive for a logical volume, delete the other partitions in this logical drive until there remains one partition only with the entire capacity. Note that deleting the partition of the logical drive will also destroy all data. Data should be backed up before making partition configurations.

When a logical drive is used as a member of a logical volume, this logical drive can no longer be partitioned in "View and Edit Logical Drives." Instead, the Logical Volume can be divided into eight partitions in "View and Edit Logical Volume."

The procedure for partitioning a logical volume is the same as that for partitioning a logical drive. After the logical volume has been partitioned, map each partition to a host ID/LUN to make the partitions available as individual drives.

As members of a logical volume, all logical drives will be forced to adopt a consistent write policy. Whenever the write policy of a logical volume is changed, for example, the corresponding setting in its members will also be changed.

RAID Expansion with Logical Volume?

The Logical Volume can also be expanded using the RAID expansion function. The concept of expanding a logical volume is similar to that of expanding a logical drive. To perform RAID expansion on a logical drive, replace each member physical drive with a drive of larger capacity or add a new drive, then perform

logical drive expansion to utilize the newly added capacity. For information about RAID expansion, please refer to *Chapter 9* "Advanced Configurations."

To perform RAID expansion on a logical volume, expand each member logical drive, then perform "RAID Expansion" on the logical volume.

Steps to expand a Logical Volume:

1. Expand each member logical drive.
2. Expand the logical volume.
3. Map the newly added capacity (in the form of a new partition) to a host LUN.

IMPORTANT!

- *If a logical unit has already been partitioned, and you wish to expand its capacity, the added capacity will be appended to the last partition. You will not be able to proceed with expansion using a firmware version earlier than 3.27 when the unit already has eight partitions.*
 - *Unless you move your data and merge two of the partitions, you will not be allowed to expand your logical volume. This is a precautionary limitation on logical unit expansion.*
-

Different Configuration Settings Using Logical Volume?

Redundant Controller

Without logical volume - logical drives can be assigned to the primary or the secondary controller. The host I/Os directed to a logical drive will be managed by the controller which owns the logical drive. If a controller fails, the host I/Os originally assigned to the failed controller will be taken over by the existing controller. When the controller fails back (a failed controller is replaced by a new one), logical drives will be returned to the replacement controller in its original configuration.

With logical volume - logical volumes can also be assigned to different controllers. The only difference is logical volumes will be used as base units when shifting control during controller failure.

A Logical Volume with Logical Drives of Different Levels?

Multi-level RAID Systems

RAID (0+1) - this is a standard feature of Infortrend RAID controllers. It brings the benefits of RAID 1 (high availability) and RAID 0 (enhanced I/O performance through striping). Simply choose multiple drives (more than two) to compose a RAID 1 logical drive, and RAID (0+1) will be automatically implemented.

RAID (1+0) or RAID 10 - a logical volume is a multi-level RAID implementation. A logical volume is a logical composition which stripes data across several logical drives (the RAID 0 method). A logical volume with several RAID 1 members can be considered as a RAID (1+0), or RAID 10 volume.

RAID (3+0) or RAID 30 - a logical volume with several RAID 3 members. A logical volume with several RAID 3 members can be considered as a RAID (3+0), or RAID 53 as defined in "The RAID Book" (from The RAID Advisory Board).

RAID (5+0) or RAID 50 - a logical volume with several RAID 5 members.

RAID Planning

This chapter summarizes the RAID configuration procedures and provides some useful tools for first-time configuration:

- | | |
|---------------------------|--|
| 2.1 Considerations | things you should know before setting up the array |
| 2.2 Configuring the Array | the basic configuration procedure |
| 2.3 Operation Theory | a brief introduction to data bus and system drive mapping |
| 2.4 Tunable Parameters | a useful tool that gives you a glimpse of important parameters |

2.1 Considerations

After you understand the basic ideas behind RAID levels, you may still be wondering how to begin. Here are the answers to some questions that may help you through the decision making process.

1. How many physical drives do you have?

When initially creating the drive groups, you should know how many drives you have in your RAID system and in the JBOD attached to the RAID controlling unit.

2. How many drives on each drive channel?

Optimal system planning is always a compromise between pros and cons. As a general rule, the number of drives you should connect on each channel equals the data bus bandwidth divided by the maximum transfer rate you can get from each of your hard drives. Knowing the mechanical performance of your hard drives can also help to determine how many drives to connect over a drive channel.

Always use fast and large drives of the same capacity for your disk array. A logical drive composed of an adequate number

of larger drives can be more efficient than a logical drive comprised of many but smaller drives.

3. How many drives would you like to appear to the host computer?

You must decide what capacity will be included in a logical configuration of drives, be it a logical drive or a logical volume. A logical configuration of drives will appear to the host as a single capacity volume.

You may compose a large logical volume consisting of drives on different drive channels/enclosures, and have it divided into smaller partitions. Each partition will appear as an independent capacity volume. In a performance-oriented configuration, you may configure the same number of drives into several RAID 0 logical drives to maximize the array performance.

4. What kind of host application?

The frequency of read/write activities can vary from one host application to another. The application can be a SQL server, Oracle server, Informix, or other database server of a transaction-based nature. Applications like video playback and video post-production editing require read/write activities of larger files coming in a sequential order.

Choose an appropriate RAID level for what is the most important for a given application – capacity, availability, or performance. Before creating your RAID, you need to choose an optimization scheme and optimize each array/controller for your application. Stripe size and write policy can be adjusted on a per logical drive basis.

5. Dual loop, hub, or switch?

Unpredictable situations like a cable coming loose can cause system down time. Fibre Channel dual loop or redundant data paths using a flexible LUN mapping method can guarantee there is no single point of failure. The use of a Fibre Channel hub or switch makes cabling and topology more flexible. Change the channel mode, connection type, and other associated settings to adjust the RAID array to your demands.

6. Optimization Mode

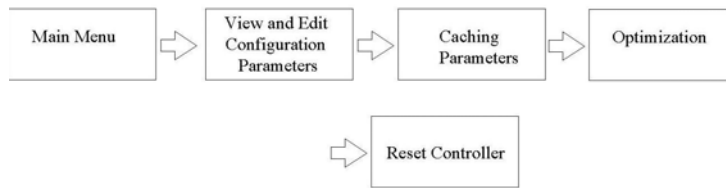

Figure 2 - 1 Optimization Setting

You should select an optimization scheme best suited to your applications before configuring a RAID array. Once the optimization mode is selected, it will be applied to all arrays in the system.

Two options are available: Sequential I/Os and Random I/Os. You may refer to the “Caching Parameters” section in *Chapter 5* and *Chapter 7* for the stripe size variables and their relation to RAID levels.

Numerous controller parameters are tuned for each optimization mode. Although stripe size can be adjusted on a per logical drive basis, users are not encouraged to make a change to the default values.

For example, smaller stripe sizes are ideal for I/Os that are transaction-based and randomly accessed. However, using the wrong stripe size can cause problems. When an array of the 4KB stripe size receives files of 128KB size, each drive will have to write many more times to store data fragments of the size of 4KB.

Unlike the previous firmware versions, controller optimization mode can be changed without changing the array stripe size.

The default values in optimization modes guarantee the optimal performance for most applications. Consult Table 2-2 for all the controller parameters that are related to system performance and fault-tolerance.

7. What RAID level?

Different RAID levels provide varying levels of performance and fault tolerance.

Table 2 - 1 RAID Levels

RAID Level	Description	Capacity	Data Availability
NRAID	Non-RAID	N	N/A
RAID 0	Disk Striping	N	==NRAID
RAID 1 (0+1)	Mirroring Plus Striping (if N>1)	N/2	>>NRAID ==RAID 5
RAID 3	Striping with Parity on dedicated disk	N-1	>>NRAID ==RAID 5
RAID 5	Striping with interspersed parity	N-1	>>NRAID ==RAID 5
Logical Volume	Striping one or more logical drives of different RAID levels	*	Higher; depends on its members

RAID Level	Performance Sequential	Performance Random
NRAID	Drive	Drive
RAID 0	R: Highest W: Highest	R: High W: Highest
RAID 1 (0+1)	R: High W: Medium	R: Medium W: Low
RAID 3	R: High W: Medium	R: Medium W: Low
RAID 5	R: High W: Medium	R: High W: Low
Logical Volume	Depends on its members; see above	Depends on its members

8. Any spare drives?

(Swap Drive Rebuild / Spare Drive Rebuild)

Spare drives allow for the unattended rebuilding of a failed drive, heightening the degree of fault tolerance. If there is no spare drive, data rebuild has to be manually initiated by replacing a failed drive with a healthy one.

As is often ignored, a spare drive (whether dedicated or global) must have a capacity no smaller than the members of a logical drive.

9. Limitations?

Firmware 3.31 and above support 64-bit LBA. A maximum of 64TB capacity can be included in single logical drive.

Up to 128 members can be included in each logical drive.

Extreme array sizes can cause operational problems with system backup and should be avoided.

2.2 Configuring the Array:

2.2.1 Starting a RAID System

Here is a flowchart illustrating basic steps to be taken when configuring a RAID system. Hardware installation should be completed before any configuration takes place.

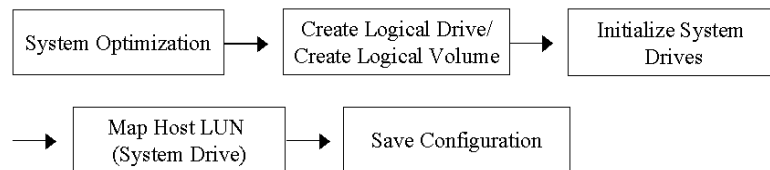

Figure 2 - 2 Array Configuration Process

Drives must be configured and the controller properly initialized before a host computer can access the storage capacity.

1. Use the LCD panel, terminal program, or the RAIDWatch manager to start configuring your array.
2. When powered on, the controller scans all the hard drives that are connected through the drive channels. If a hard drive is connected after the controller completes initialization, use the "Scan SCSI Drive" function to let the controller recognize its presence.
3. Optimize the controller's parameters for your applications.
4. Configure one or more logical drives to contain your hard drives based on the desired RAID level, and/or partition the logical drive or logical volume into one or several partitions.

NOTE:

- *A "logical drive" is a set of drives grouped together to operate under a given RAID level and it appears as a single contiguous volume. The controller is capable of grouping drives into as many as 128 logical drives, configured in the same or different RAID levels.*
 - *A total of 32 "logical volumes" can be created each from one or several logical drives. A logical drive or logical volume can be divided into a maximum of 64 "Partitions."*
-

5. The next step is to make logical drives or storage partitions available through the host ports. When associated with a host ID or LUN number, each capacity volume appears as one system drive. The host SCSI or Fibre adapter will recognize the system drives after the host bus is re-initialized.
6. The last step is to save your configuration profile in the host system drive or to the logical drives you created.

The controller is totally independent from the host operating system. The host operating system will not be able to tell whether the attached storage is a physical hard drive or the virtual system drives created by the RAID controller.

2.3 Operation Theory

2.3.1 I/O Channel, SCSI ID, and LUN

Depending on the interface used by a RAID system, a SCSI drive channel (SCSI bus) can connect up to 15 drives (excluding the RAID controller itself). A Fibre Channel has up to 125 drives in a loop. Each device occupies one unique ID.

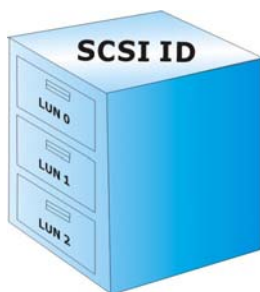

The figure on the left illustrates the idea of mapping a system drive to host ID/LUN combinations. The host ID is like a cabinet, and the drawers are the LUNs (LUN is short for Logical Unit Number). Each cabinet (host ID) contains up to 32 drawers (LUNs). Data can be made available through one of the LUNs of a host ID. Most host adapters treat a LUN like another device.

Figure 2 - 3 SCSI ID/LUNs

2.3.2 Grouping Drives into an Array

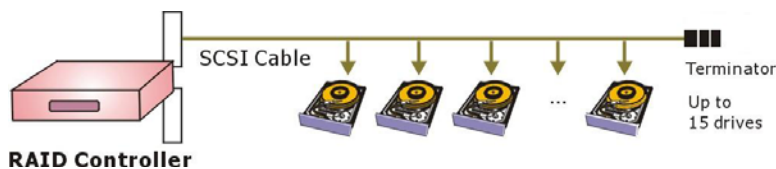

Figure 2 - 4 Connecting Drives

The physical connection of a RAID controller should be similar to the one shown above. Drives are connected through I/O paths that have been designated as drive channels.

The next diagram shows two logical configurations of drives and the physical locations of its members. Using drives from different channels can lower the risk of fatal failure if one of the drive channels fails. There is no limitation on the locations of spares.

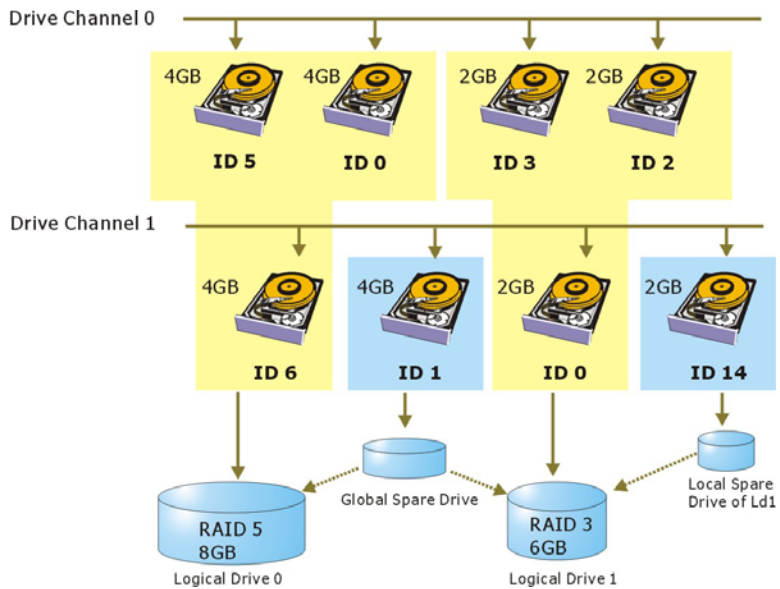

Figure 2 - 5 Physical Locations of Drive Members

A drive can be assigned as the Local Spare Drive that serves one specific logical drive, or as a Global Spare Drive that participates in the rebuild of any logical drive. Spares automatically joins a logical drive when a drive fails. Spares are not applicable to logical drives that have no data redundancy (NRAID and RAID 0).

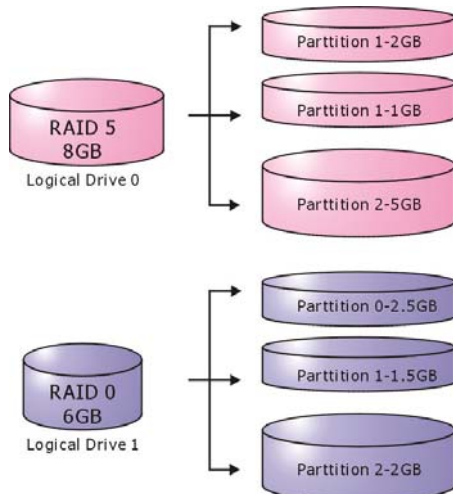

Figure 2 - 6 Partitions in Logical Configurations

You may divide a logical drive or logical volume into partitions of desired capacity, or use the entire capacity as a single volume.

1. It is not a requirement to partition any logical configuration. Partitioning helps to manage a massive capacity.
2. Note that a logical drive can not be included in a logical volume if it has already been partitioned.

2.3.3 Making Arrays Available to Hosts

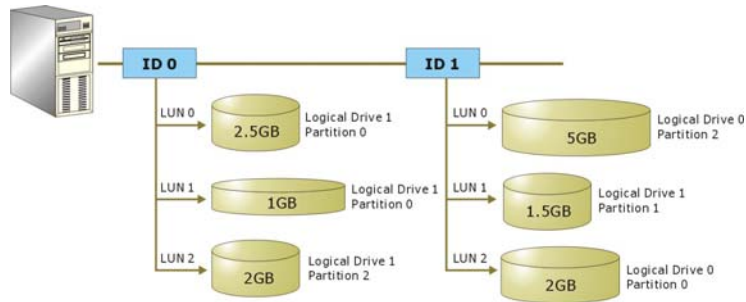

Figure 2 - 7 Mapping Partitions to Host ID/LUNs

Host ID mapping is a process that associates a logical configuration of drives with a host channel ID/LUN. To avail logical partitions on host channel(s), map each partition to a host ID or one of the LUNs under host IDs. Each ID or LUN will appear to the host adapter as one virtual hard drive.

There are alternatives in mapping for different purposes:

1. Mapping a logical configuration to IDs/LUNs on different host channels allows two host computers to access the same array. This method is applicable when the array is shared in a clustering backup.
2. Mapping partitions of an array to IDs/LUNs across separate host channels can distribute workload over multiple data paths.
3. Mapping across separate host channels also helps to make use of all bandwidth in a multi-path configuration. Firmware automatically manages the process when one data path fails and the workload on the failed data path has to be shifted to the existing data paths.

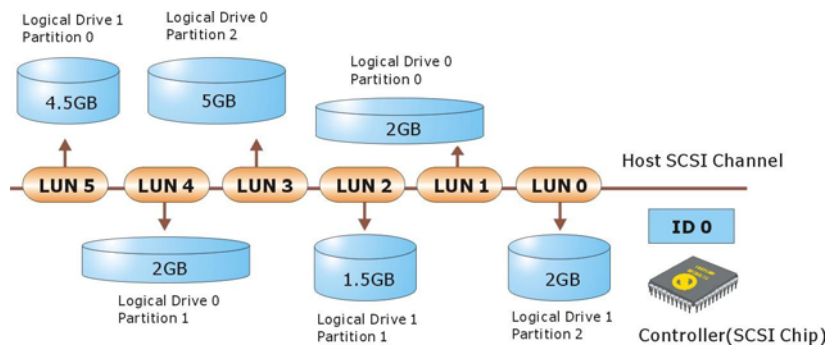

Figure 2 - 8 Mapping Partitions to LUNs under ID

2.4 Tunable Parameters

Fine-tune the controller and the array parameters for your host applications. Although the factory defaults guarantee the optimized controller operation, you may refer to the table below to facilitate tuning of your array. Some of the performance and fault-tolerance settings may also be changed later during the preparation process of your disk array.

Use this table as a checklist and make sure you have each item set to an appropriate value.

Table 2 - 2 Controller Parameter Settings

- | | |
|-----|---|
| (1) | Parameters that should be configured at the initial stage of system configuration |
| (2) | Parameters that can be changed later |
| (3) | Non-critical |

User-Defined Parameters	Default	Alternate Settings
Fault Management:		
(1) Automatic Logical Drive Rebuild - Spare Drive	Enabled when Spare Drive is available	RAID 1 + Local Spare RAID 3 + Local Spare RAID 5 + Local Spare Global Spare
(1) Host-side Re-routing: Failover Mode configuration	Shared	Independent
(1) S.M.A.R.T.	Disabled	Detect Only Perpetual Clone Clone + Replace
(3) Clone Failing Drive	Manual function	Replace After Clone Perpetual Clone
(1) Rebuild Priority	Low (higher priority requires more system resources)	Low Normal Improved High
(1) Verification on Write	Disabled	On LD Initialization On LD Rebuild On Normal Drive Writes
(3) SDRAM ECC	Disabled	Enabled
(2) Periodic Cache Flush	Disabled	Continuous to 10 minutes
(1) Event Notification	Reports to user interface and onboard alarm	Over SNMP Traps Over Java-Based Management Software
(2) Periodic Auto-Detect Failure Drive Swap Check Time	Disabled	Disabled, 5~60 seconds
(2) Periodic Drive Check Time	Disabled	Disabled, 0.5~30 seconds
(2) Rebuild Priority	low	Low, normal, improved, high

Controller:		
(1) Channel Mode	*	Host, Drive, RCCOM, Drive + RCCOM
(1) Host and Drive Cchannel IDs	*	*
(1) Controller Unique Identifier	Preset on some models	Hex number from 0 to FFFFF (FW 3.25 and above)
(2) Data Rate	Auto	Depends on problems solving
(1) Date and Time	N/A	
(1) Time Zone	+ 8 hrs	

Optimization Mode:		
(1) Write-back Cache	Enabled	Disabled
(1) Array Stripe Size	Related to controller general setting	4KB to 256KB
(2) Adaptive Write Policy	Disabled	Enabled
(1) Optimization for Random/Sequential	Sequential	Either
(2) Array Write Policy	Related to controller general setting	W/B or W/T

SCSI Parameters:		
(1) Data Transfer Rate	*	Async. To 133.0MHz
(1) Maximum Tag Count	32	1-128
(1) Maximum Queued I/O Count	32	32 to 1024
(2) LUN's per SCSI ID	8	Up to 32
(1) Periodic Drive Check Time	Disabled	Enabled
(1) Periodic SAF-TE and SES Device Check Time	5	Disabled to 60 seconds
(1) Periodic Auto-Detect Failure Drive Swap Check Time	Disabled	5 to 60 seconds
(1) Number of Host-LUN Connection	32	1 to 1024
(1) Tag per Host-LUN Connection	32	1 to 256
(1) Wide Transfer	*	Enabled/Disabled
(1) Parity Check	Disabled	Enabled
Spin-Up Parameters:		
(1) Motor Spin-Up	Disabled	Enabled
(1) Reset at Power-UP	Enabled	Disabled
(1) Initial Disk Access Delay	*	None to 75 seconds

Data Integrity:		
(3) Task Scheduler	N/A	Execute on initialization Start time and date Execution period Media scan mode Media scan priority Logical drive selection

Fibre Channel Parameters:		
(1) Fibre Connection Options	*	Loop Only Point-to-Point Only Loop Preferred Point-to-Point Preferred
(1) Fibre Channel Dual-Loop	Enabled	Enabled by cabling connection
(1) Host ID/WWN Name List	*	User configurable
(1) LUN Filtering	*	Host access filter configurable: - filter type - access right - name
(1) RCC through Fibre Channel	*	Dedicated or sharing drive channel(s)
Array Configuration:		
(1) Disk Reserved Space	256MB	
(1) Guaranteed Latency Loss (AV option) - Max Drive Response Timeout	Disabled	160, 250, or 500ms
(2) Array Assignment	Primary controller	Secondary controller
(1) Array Partitioning	1	Up to 64
(1) Auto-assign Global Spare	disabled	enabled

Enclosure Monitoring:		
(2) Periodic SAF-TE/SES Device Check Time	30 seconds	Disabled, 50ms~60 seconds
(2) Event Triggered Operation	N/A	Controller, fan, PSU, BBU, UPS, and elevated temperature Auto-shutdown: 2 mins~1 hour
(1) Thresholds for Voltage and Temperature Self-Monitoring	CPU temp: 0~90°C Board temp: 0~80°C 3.3V: 2.9~3.6V 5V: 4.5~5.5V 12V: 10.8~13.2V	User-Defined; do not change parameters unless necessary

Others:		
(3) Password	N/A	User-Defined; Password Validation Timeout: 1 to Always Check Configurable
(3) LCD Display Controller Name	N/A	User-defined
(1) Network Protocol Support	All enabled except SSH	No configuration options

Accessing the Array: Serial Port, Ethernet, and Access Security

3.1 RS-232C Serial Port

Infortrend's controllers and subsystems can be configured via a PC running a VT-100 terminal emulation program, or a VT-100-compatible terminal. RAID enclosures usually provide one or more DB-9 RS-232C ports. Simply use an RS-232C cable to connect between the controller/enclosure's RS-232C port and the PC serial (COM) port.

Make sure you use the included null modem (IFT-9011) to convert the serial port signals. A null modem might have been provided inside your enclosure. The null modem has the serial signals swapped for connecting to a standard PC serial interface.

The following are guidelines on using the serial port:

- The serial port's default is set at 38400 baud, 8 bit, 1 stop bit and no parity. Use the COM1 serial port of the controller.
- In most cases, connecting RD, TD, and SG is enough to establish communication with a terminal.
- If you are using a PC as a terminal, any VT-100 terminal emulation software will suffice. Microsoft® Windows includes a terminal emulation program as presented with the "(Hyper) Terminal" icon in the Accessories window.
- For other details on connecting to the serial port, please refer to the *Hardware Manual* that came with your controller.

3.1.1 Configuring RS-232C Connection via Front Panel

Follow the steps below to change the baud rate using the front panel keypad:

Press **ENT** for two seconds to enter the Main Menu. Press τ or σ to select "View and Edit Configuration ..", then press **ENT**.

```
View and Edit
Config Params  .
```

Select "Communication Parameters ..", then press **ENT**.

```
Communication
Parameters    ..
```

Select "RS-232 Configuration ..", then press **ENT**.

```
RS-232C
Configuration ..
```

Select "COM1 Configuration ..", then press **ENT**.

```
COM1
Configuration ..
```

Select "Baud-rate 38400 ..", then press **ENT**.

```
Baud-rate 38400
..
```

The baud rate default is 38400. If another baud rate is preferred, press the up or down keys to select the baud rate, then press **ENT** for 2 seconds to confirm the selected baud rate. Set the identical baud rate to your RAID array and your terminal computer.

```
Baud-rate 38400
Change to 19200?
```

- The following baud rates are available: 2400, 4800, 9600, 19200 and 38400.
- Terminal connection should work properly using the above setting. You may check the following options in your COM port configuration if you encounter problems:
 1. "Comm Route Dir ..": The communication route should be configured as "direct to port" instead of "through PPP."
 2. "Term Emul. Enab ..": Make sure the terminal function has not been accidentally disabled.

3.1.2 Starting RS-232C Terminal Emulation

The keys used when operating via the terminal are as follows:

- ← → ↑ ↓ To select options
- [Enter] To go to a submenu or to execute a selected option
- [Esc] To escape and go back to the previous menu
- [Ctrl] [L] To refresh the screen information

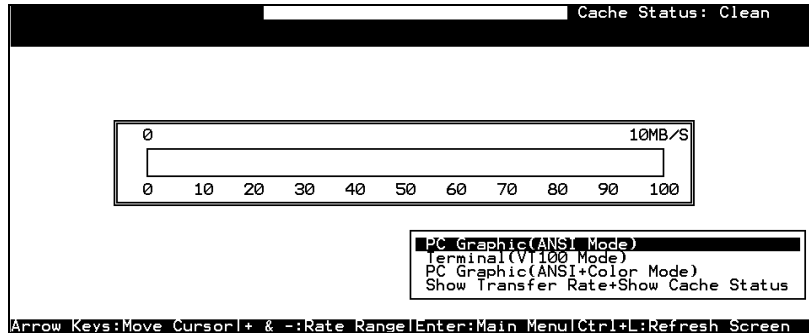

IMPORTANT!

- *If the RS-232C cable is connected while the controller is powered on, press [Ctrl] [L] to refresh the screen information.*

The initial screen appears when the controller finishes its self-test and is properly initialized. Use ↑ ↓ arrow keys to select terminal emulation mode, then press [ENTER] to enter the Main Menu.

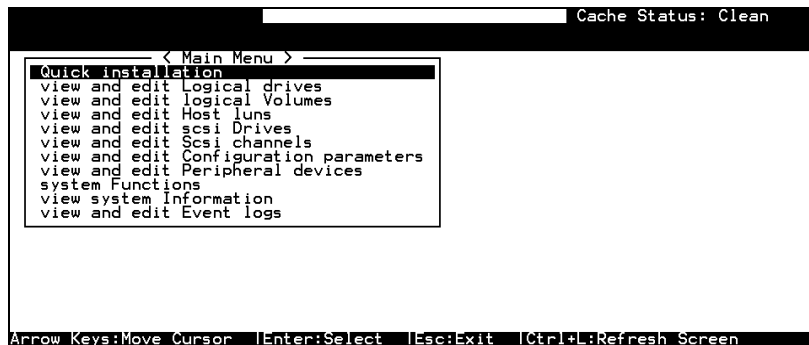

Choose a functional item from the main menu to begin configuring your RAID.

3.2 Out-of-Band via Ethernet

The RAIDWatch manager software provides a graphical interface to RAID subsystems. RAIDWatch comes with an installer program that facilitates the installation of software modules for remote access to the array through the Internet (Applet mode). Before a remote browser can access the array, prepare the following:

1. TCP/IP for the controller/subsystem Ethernet port.
2. Array reserved space. The reserved space is automatically formatted with every logical configuration of disk drives.
3. If the subsystem has no configured arrays, host channel peripheral device settings must be ready.

What is the “Disk Reserved Space?”

RAIDWatch and Reserved Space:

- User’s configuration data and the manager’s main programs are kept in a small section of disk space on each data drive. The segregated disk space is called a “Disk Reserved Space.” When configuring a logical drive, the firmware automatically segregates 256MB of disk space from each of the member drives.
- Because the RAIDWatch manager’s main program is run from the reserved space on the drives, in the event of single controller failure, the manager interface can “failover” to a counterpart controller. Operators’ access to the system will not be interrupted.

Other Concerns

Availability Concern

For safety reasons, it is better to create a reserved space on more than one logical drive. The reserved space information can be seen during the array creation process.

Whatever data is put into the reserved space, the firmware will automatically duplicate and distribute it to the reserved section on

every data drive. Even if one hard drive or one logical drive fails, an exact replica still resides on other drives.

Web-based Management

The controller firmware has embedded http server. Once properly configured, the controller/subsystem's Ethernet port behaves like an HTTP server.

3.2.1 Connecting Ethernet Port:

Use a LAN cable to connect the Ethernet port(s) on the subsystem's RAID controller unit(s). Use only shielded cable to avoid radiated emissions that may cause interruptions. Connect the cables between controller's LAN port and a LAN port from your local network.

3.2.2 Configuring the Controller

To prepare the controller for Ethernet connection, do the following:

1. Use a Terminal Emulator to Begin Configuration

Connect the subsystem's serial port to a PC running a VT-100 terminal emulation program or a VT-100-compatible terminal.

Make sure the included null modem is already attached to enclosure serial port or the host computer's COM port. The null modem converts the serial signals for connecting to a standard PC serial interface. For more details, please refer to the descriptions above in *Section 3.1*.

2. Create a Reserved Space on the Drives

LG	ID	LV	RAID	Size(MB)	Status	1	2	3	0	C	#LN	#SB	#FL	NAME
0			NONE											
Maximum Drive Capacity : 26444MB Assign Spare Drives Disk Reserved Space: 256 MB Write Policy: Default(Write-Back) Initialize Mode: On-Line Stripe Size: Default														
5			NONE											
6			NONE											
7			NONE											

Cache Status: Clean
Write Cache: Enable

Arrow Keys: Move Cursor | Enter: Select | Esc: Confirm | Ctrl+L: Refresh Screen

Create one or more logical drives and the reserved space option will be automatically available. The default size is 256MB, and it is recommended to keep it as is. A reserved disk space will be formatted from every member drive.

If you delete a logical drive later, the reserved space will remain intact. Unless you manually remove the reserved space, data kept in it will be unaffected. These drives can later be used to create a new logical drive without making additional changes.

Quick view	Slot	Chl	ID	Size(MB)	Speed	LG_DRV	Status	Vendor and Product ID
view	1	0	0	4857	80MB	NONE	FRMT DRV	
view	1	1	1	4857	80MB	NONE	FRMT DRV	
view	1	2	2	4857	80MB	NONE	FRMT DRV	
view	1	3	3	4857	80MB	NONE	NEW DRV	
view	1	4	4	4857	80MB	NONE	NEW DRV	
view	1	5	5	4857	80MB	NONE	NEW DRV	
view	1	6	6	4857	80MB	NONE	NEW DRV	
view	1	8	8	4857	80MB	NONE	NEW DRV	

Cache Status: Clean
Write Cache: Enable

Arrow Keys: Move Cursor | Enter: Select | Esc: Exit | Ctrl+L: Refresh Screen

When formatted, a meta-filesystem is created on the 256MB reserved space. A drive configured with a reserved space will be stated as a "formatted drive."

3. Assign an IP Address to the Ethernet Port

Assign an IP address to the controller Ethernet port and specify the Net Mask and Gateway values. Power off your system and then power on again for the configuration to take effect.

Select "View and Edit Configuration Parameters" from the main menu. Select "Communication Parameters" -> "Internet Protocol (TCP/IP)" -> press [ENTER] on the chip hardware address -> and then select "Set IP Address."

```

      < Main Menu >
Quick installation
view and edit Logical drives
view and edit logical Volumes
view and edit Host luns
view and edit scsi Drives
view and edit Scsi channels
view and edit Configuration parameters
v
v
v
v
Communi
Communi
View Statistics
Set IP Address
Routing Table Configuration
RS-2
LAN0[R8192C] HwAddr 00:D0:23:00:00:00 - 192.168.20.19
P
M
S
Internet Protocol (TCP/IP)
File System Maintenance

```

Provide the IP address, NetMask, and Gateway values accordingly.

```

      < Main Menu >
Quick installation
view and edit Logical drives
view and edit logical Volumes
view and edit Host luns
view and edit scsi Drives
view and edit Scsi channels
view and edit Configuration parameters
v
v
v
v
Communi
Communi
Address: 192.168.20.00
NetMask: 255.255.255.0
Gateway: Not Set
RS-2
LAN0[R8192C] HwAddr 00:D0:23:00:00:00 - 192.168.20.00
P
M
S
Internet Protocol (TCP/IP)
File System Maintenance

```

PING the IP address from your management computer to make sure the link is up and running.

3.3 Secure Link over SSH

Firmware supports remote management over the network connection and the security under SSH (Secure Shell) protection. SSH is widely used for its ability to provide strong authentication and secure communications over insecure channels

To access the firmware embedded configuration utility over the SSH network, do the following:

1. Open a web browser.
2. Key in the line below in the browser's URL field.

```
http://<controller IP>/ssh.htm
```
3. Enter controller name (if there is any) as user name and the password set for the subsystem. If neither the controller name or password has been set, press Enter at each command prompt to proceed.

LCD Screen Messages

4.1 The Initial Screen

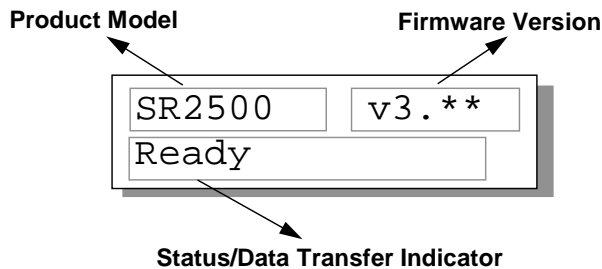

Status/Data Transfer Indicator:

- | | |
|-------------|---|
| Ready | There is at least one logical drive or logical volume mapped to a host ID/LUN. |
| No Host LUN | No logical drive created or the logical drive has not yet been mapped to any host ID/LUN. |
| ■■■■■■ | Indicates data transfer. Each block indicates 256Kbytes of data throughput. |

4.2 Quick Installation Screen

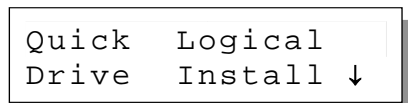

Press [ENT] to create a logical drive. The controller/subsystem will start initialization of one logical drive with all the connected SCSI drives and automatically map the logical drive to LUN 0 of the first host channel. The "Quick Installation" can only be performed when there is no logical drive.

4.3 Logical Drive Status

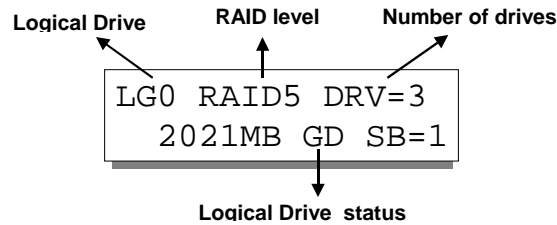

Logical Drive: The Logical Drive number.
RAID level: The RAID level used in this logical drive.
Number of Drives: The number of physical drives included in this configuration.

Logical Drive status:

XxxxMB The capacity of this logical drive.
 SB=x Standby drives available to this logical drive. Except the spares dedicated to other logical configurations, all spare drive(s) will be counted in this field, including Global and Local Spares.

xxxxMB INITING The logical drive is now initializing.

xxxxMB INVALID For firmware version before 3.31:
 The logical drive has been created with "Optimization for Sequential I/O", but the current setting is "Optimization for Random I/O."

-OR-

The logical drive has been created with "Optimization for Random I/O," but the current setting is "Optimization for Sequential I/O."

Firmware version 3.31 has separate settings for array optimization and array stripe size. This message will not appear when the optimization mode is changed.

xxxxMB GD SB=x The logical drive is in good condition.

xxxxMB FL SB=x One drive failed in this logical drive.

xxxxMB RB SB=x Logical Drive is rebuilding.

xxxxMB DRVMISS One of the drives is missing.

INCOMPLETE Two or more drives failed in this logical drive.
 ARRAY

4.4 Logical Volume Status

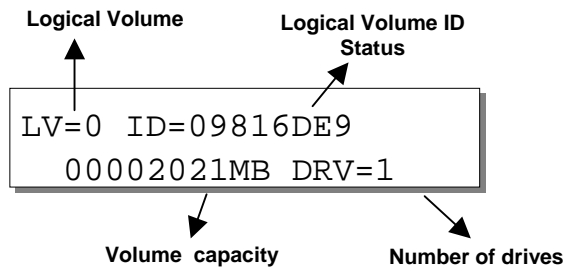

Logical Volume:	The Logical Volume number.
DRV=x:	The number of logical drive(s) contained in this logical volume.
Logical Volume ID Status:	The unique ID number of the logical volume (controller random generated).
Logical Volume Status:	
xxxMB	The capacity of this logical volume.

4.5 SCSI Drive Status

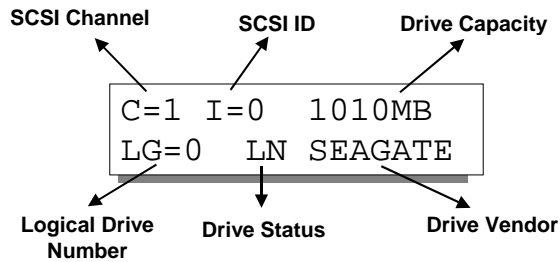

Drive Status:

LG=x IN	Initializing
LG=x LN	On-line (already a member of a logical configuration)
LG=x RB	Rebuilding
LG=x SB	Local Spare Drive
GlobalSB	Global Spare Drive
NEW DRV	New drive
BAD DRV	Failed drive
ABSENT	Drive does not exist
MISSING	Drive missing (drive was once there)
SB-MISS	Spare drive missing

4.6 SCSI Channel Status

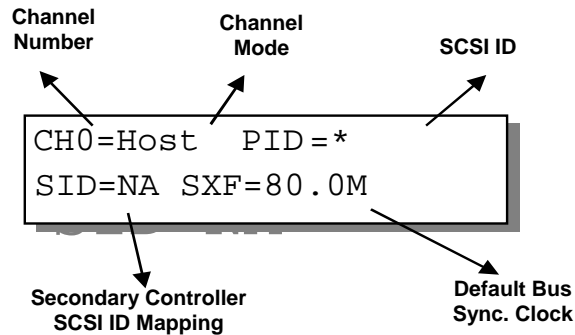

Channel Mode:

Host	Host Channel mode
Drive	Drive Channel mode

Default SCSI Bus Sync Clock:

80.0M	The default setting of this channel is 80.0MHz in Synchronous mode
Async	The default setting of this SCSI channel is in Asynchronous mode

Primary Controller SCSI ID Mapping:

*	Multiple SCSI ID's applied (Host Channel mode only)
(ID number)	Primary Controller is using this SCSI ID for host LUN mapping.
NA	No SCSI ID applied (Drive Channel mode only)

Secondary Controller SCSI ID Mapping:

*	Multiple SCSI ID's applied (Host Channel mode only)
(ID number)	Secondary Controller is using this SCSI ID for host LUN mapping.
NA	No SCSI ID applied (Drive Channel mode only)

4.7 Controller Voltage and Temperature

Press **ENT** for two seconds to enter the Main Menu. Press τ or σ to select "View and Edit Peripheral Dev," then press **ENT**.

Press τ or σ to select "Ctrl Peripheral Device Config.," press **ENT** and then choose "View Ctlr Periph Device Status.," then press **ENT**.

Press τ or σ to choose either "Voltage Monitor," or "Temperature Monitor".

Select "Temperature and Voltage Monitor" by pressing **Enter**. Press τ or σ to browse through the various voltage and temperature statuses.

```
View and Edit  
Peripheral Dev .
```

```
Ctlr Peripheral  
Device Config..
```

```
View Ctlr Periph  
Device Status..
```

```
Voltage Monitor  
..
```

```
Temperature  
Monitor ..
```

```
[+12V] 12.077V  
Operation Normal
```

```
[+5v] 4.938v  
Operation Normal
```

```
[+3.3V] 3.384V  
Operation Normal
```

```
[CPU] 43.5°C  
in Safe Range
```

```
[+12v] 12.077v  
Operation Normal
```

```
[CPU] 43.5°C  
in Safe Range
```

```
[Board]46.5°C  
in Safe Range
```

```
[Board1]46.5°C  
in Safe Range
```

4.8 Cache Dirty Percentage

The LCD panel indicates the cache dirty percentage. The amber-colored "busy" light blinking on front panel also indicates that the cache is being accessed.

4.9 View and Edit Event Logs

Press ENT for two seconds to enter the Main Menu. Press τ or σ to select "View and Edit Event Logs," then press ENT.

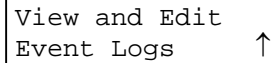

View and Edit
Event Logs ↑

Press τ or σ to browse through the existing event log items.

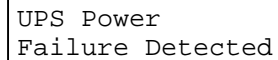

UPS Power
Failure Detected

To delete a specified item and all events prior to this event, press ENT for 2 seconds.

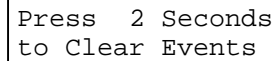

Press 2 Seconds
to Clear Events

IMPORTANT!

- *The event log will be cleared after the controller is powered off or reset.*
-

LCD Keypad Operation

5.1 Power On the RAID Enclosure

Before you start to configure a RAID system, make sure that hardware installation is completed before any configuration takes place. Power on your RAID enclosure.

NOTE:

- *The RAID controller units of the EonStor subsystems come in separate packages. Chances are that a secondary controller may be installed to the controller slot at the upper position. As the result, your subsystem's LCD panel provides access to the Secondary controller. However, in the dual-redundant configuration, only the Primary controller responds to user's configuration.*

Each controller's operating mode is indicated by the flashing digit on the upper right of the LCD screen as "P" or "S." If the LCD displays "S," press the Up and Down arrow keys for one second to switch around the access to different controllers.

5.2 Caching Parameters

Optimization Modes

Mass storage applications can be divided into two categories according to its read/write characteristics: database and video/imaging. To optimize the controller for these two categories, the controller has two embedded optimization modes with controller behaviors adjusted to different read/write parameters. They are the Optimization for Random I/O and the Optimization for Sequential I/O.

Limitations: There are limitations on the use of optimization modes.

1. You can select the stripe size of each array (logical drive) during the initial configuration. However, changing stripe size is only recommended for experienced engineers who have tested the effects of tuning stripe sizes for different applications.
2. The array stripe size can only be changed during the initial configuration process.
3. Once the controller optimization mode is applied, access to different logical drives in a RAID system will follow the same optimized pattern. You can change the optimization mode later without having to re-organize your array.

Database and Transaction-based Applications:

These kinds of applications usually include SQL server, Oracle server, Informix, or other database services. These applications keep the size of each transaction down to the minimum, so that I/Os can be rapidly processed. Due to their transaction-based nature, these applications do not read or write a bunch of data in sequential order - access to data occurs randomly. The transaction size usually ranges from 2K to 4K. Transaction performance is measured in "I/Os per second" or "IOPS."

Video Recording/Playback and Imaging Applications:

These kinds of applications usually includes video playback, video post-production editing, or other similar applications. These applications have the tendency to read or write large files from and into storage in sequential order. The size of each I/O can be 128K, 256K, 512K, or up to 1MB. The efficiency of these applications is measured in "MB/sec."

When an array works with applications such as video or image oriented applications, the application reads/writes from the drive as large-block, sequential threads instead of small and randomly accessed files.

The controller optimization modes have read-ahead buffer and other R/W characteristics tuned to obtain the best performance for these two major application categories.

Optimization Mode and Stripe Size

Each controller optimization mode has preset values for the stripe size of arrays created in different RAID levels. If you want a different value for your array, you may change the controller optimization mode, reset the controller, and then go back to create the array. Once the array is created, stripe size cannot be changed.

Using the default value should be sufficient for most applications.

	Opt. For Sequential I/O	Opt. for Random I/O
RAID0	128	32
RAID1	128	32
RAID3	16	4
RAID5	128	32

Optimization for Random or Sequential I/O

Select from Main Menu "View and Edit Config Params," "Caching Parameters," and press **ENT**. Choose "Optimization for Random I/O" or "Optimization for Sequential I/O," then press **ENT** for two seconds to confirm. Press **ESC** to leave and the setting will take effect after the controller is restarted.

```
Caching
Parameters  ..
```

```
Optimization I/O
Random      ..
```

```
Optimization for
Sequential I/O?
```

IMPORTANT!

- *The original 512GB threshold on array optimization mode is canceled. If the size of an array is larger than 16TB, only the optimization for sequential I/O can be applied. Logical drives of this size are not practical; therefore, there is actually no limitation on the optimization mode and array capacity.*
-

Write-back/Write-through Cache Enable/Disable

As one of the submenus in "Caching Parameters," this option controls the cached write function. Press **ENT** to enable or disable "Write-back Cache." Press **ENT** for two seconds to confirm. The current status will be displayed on the LCD.

```
Write-Back Cache
Enabled      ..
```

The Write-through mode is safer if your controller is not configured in a redundant pair and there is no battery backup.

```
Disable Write
-Back Cache    ?
```

Write-back caching can dramatically improve write performance by caching the unfinished writes in memory and letting them be committed to drives latter in a more efficient manner. In the event of power failure, a battery module can hold cached data for days. In the event of controller failure, data cached in the failed controller has an exact replica on its counterpart controller and therefore remains intact.

Periodic Cache Flush

If for a reason Write-Back caching is preferred for better performance and yet data integrity is of the concern, e.g., lack of the battery protection, the system can be configured to flush the cached writes at every preset interval.

Note that the “Continuous Sync” option holds data in cache for as long as necessary to complete a write operation and immediately commits it to hard drives if it does not come in a series of sequential write requests.

Select from Main Menu “View and Edit Config Parm,” “Caching Parameters,” and press **ENT**. Use the arrow keys to scroll through the options and select “Periodic CachFlush Time”, and then press **ENT** to proceed. The “Set Cache Flush Time - Disable” appears. The default is “Disable.” Use your arrow keys to select an option from “ConSync,” “1/2min,” to “10min.” “ConSync” stands for “continuously synchronized.” Press **ENT** to select and press **ESC** to leave and the setting will take effect immediately.

```
Period CachFlush
Time - Disable
```

```
Set Cache Flush
Time - Disable
```

IMPORTANT!

- *Every time you change the caching parameters, you must reset the controller for the changes to take effect.*
 - *In the redundant controller configuration, write-back will only be applicable when there is a synchronized cache channel between partner controllers.*
-

5.3 View Connected Drives:

A RAID system consists of many physical drives that can be modified and configured as the members of one or several logical drives.

Press the front panel **ENT** button for two seconds to enter the Main Menu. Use the up or down arrow keys to navigate through the menus. Choose "View and Edit SCSI Drives," then press **ENT**.

```
View and Edit
SCSI Drives
```

Use the up or down arrow keys to scroll down the list of connected drives' information screens.

```
C=2 I=0 1010MB
New DRV SEAGATE
```

You may first examine whether there is any drive installed but not shown here. If there is a drive installed but not listed, the drive may be defective or not installed correctly. Please check your enclosure installation and contact your system vendor.

Press **ENT** on a drive. Choose "View Drive Information" by pressing **ENT**. Use the up or down arrow keys to navigate through the screens.

```
View Drive
Information ..
```

The Revision Number of the selected SCSI drive will be shown. Press τ to see other information.

```
Revision Number:
0274
```

Other information screens include "Serial Number" and "Disk Capacity" (displayed in blocks; each block equals 512K Bytes).

IMPORTANT!

- *Drives of the same brand/model/capacity might not feature the same block number.*
 - *The basic read/write unit of a hard drive is a block. If members of a logical drive have different block numbers (capacity), the smallest block number will be taken as the maximum capacity to be used in every drive. Therefore, use drives of the same capacity.*
 - *You may assign a Local/Global Spare Drive to a logical drive whose members have a block number equal to or smaller than the Local/Global Spare Drive but you should not do the reverse.*
-

5.4 Creating a Logical Drive

To create a logical drive, press **ENT** for two seconds to enter the Main Menu. Use the up or down arrow keys to navigate through the menus. Choose "View and Edit Logical Drives," and then press **ENT**.

```
View and Edit
Logical Drives
```

Press the up or down arrow keys to select a logical drive entry, then press **ENT** for two seconds to proceed. "LG" is short for Logical Drive.

```
LG=0
Not Defined ?
```

Choosing a RAID Level

Press τ or σ to choose the desired RAID level, then press **ENT** for two seconds. "TDRV" (Total Drives) refers to the number of available SCSI drives.

```
TDRV=4 Create
LG Level=RAID5 ?
```

Choosing Member Drives

Press **ENT** for two seconds; the message, "RAID X selected To Select drives", will prompt. Confirm your selection by pressing **ENT**.

```
RAID X Selected
To Select drives
```

Press **ENT**, then use the up or down arrow keys to browse through the available drives. Press **ENT** again to select/deselect the drives. An asterisk (*) mark will appear on the selected drive(s). To deselect a drive, press **ENT** again on the selected drive. The (*) mark will disappear. "C=1 I=0" refers to "Channel 1, SCSI ID 0".

```
C=1 I=0 1010MB
NEW DRV SEAGATE
```

After all the desired drives have been selected, press **ENT** for two seconds to continue. Press the up or down arrow keys to choose "Create Logical Drive," then press **ENT** for two seconds to start initializing the logical drive.

```
Create Logical
Drive ?
```

Logical Drive Preferences

You may also choose "Change Logical Drive Parameter," then press **ENT** to

```
Change Logical
Drive Parameter?
```

change related parameters before initializing the logical drive.

Maximum Drive Capacity

Choose "Maximum Drive Capacity," then press **ENT**. The maximum drive capacity refers to the maximum capacity that will be used in each member drive.

```
Maximum Drive
Capacity      ..
```

Use the up and down arrow keys to change the maximum size that will be used on each drive.

```
MaxSiz= 1010MB
Set to   1010MB?
```

Spare Drive Assignments

The Local Spare Drive can also be assigned here. Press the up or down arrow keys to choose "Spare Drive Assignments," then press **ENT**.

```
Spare Drive
Assignments  ..
```

Available drives will be listed. Use the up or down arrow keys to browse through the drive list, then press **ENT** to select the drive you wish to use as the Local Spare Drive. Press **ENT** again for two seconds.

```
C=1 I=15 1010MB
*LG=0 SL SEAGATE
```

Disk Reserved Space

This menu allows you to change the size of disk reserved space. Default is 256MB. We recommended using the default value.

```
Disk Rev. Space
256MB      ..
```

Choices are 256MB and 64KB. With 64KB, logical drives are backward compatible to RAID controllers running earlier firmware versions. Press **ENT** and use the up or down keys to choose the size you prefer.

Write Policy

This menu allows you to set the caching mode policy for this specific logical drive. "Default" is a neutral value that is coordinated with the controller's caching mode setting. Other choices are "Write-back" and "Write-through."

```
Write Policy
Default     ..
```

Initialization Mode

This menu allows you to determine if the logical drive is immediately accessible. If the Online method is used, data can be written onto it before the array's initialization is completed. Users may proceed with array configuration, e.g., including this array in a logical volume.

```
Initialization
Mode      Online..
```

Array initialization can take a long time especially for those comprised of large capacity. Setting to "Online" means the array is immediately accessible and that the controller will complete the initialization when I/O demands become less intensive.

Stripe Size

This menu allows you to change the array stripe size. Setting to an incongruous value can severely drag performance. This item should only be changed when you can be sure of the performance gains it might bring you.

```
Stripe size
Default    ?
```

Listed below are the default values for an array. The default value for the stripe size is determined by the controller Optimization Mode and the RAID level chosen for an array.

Table 5 - 1 RAID Level, Optimization Modes, and Stripe Size

	Opt. for Sequential I/O	Opt. for Random I/O
RAID0	128	32
RAID1	128	32
RAID3	16	4
RAID5	128	32

When you are done setting logical drive preferences, press **ESC** and use your arrow keys to select "Create Logical Drive?". Press **ENT** for two seconds to proceed.

Beginning Initialization

Press **ESC** to return to the previous menu. Use the up or down arrow keys to choose "Create Logical Drive," then press **ENT** for two seconds to start initializing the logical drive.

```
Create Logical
Drive          ?
```

The Online Mode:

If the online initialization method is applied, the array will be available for use immediately. The array initialization runs in the background while data can be written onto it and users can continue configuring the RAID system.

```
LG=0 Creation  
Completed!
```

The Offline Mode:

The controller will start to initialize the array parity if using the "offline" mode. Note that if NRAID or RAID 0 is selected, initialization time is short and completes almost immediately.

```
Initializing090%  
Please Wait!
```

```
LG=0 Initializat  
Ion Completed
```

The logical drive's information displays when the initialization process is completed. If the "online" mode is adopted, array information will be displayed immediately.

```
LG=0 RAID5 DRV=3  
2012MB GD SB=0
```

5.5 Creating a Logical Volume

Press **ENT** for two seconds to enter the Main Menu. Press the up or down arrow keys to select "View and Edit Logical Volume," then press **ENT**.

```
View and Edit
Logical Volume .
```

Press τ or σ to select an undefined entry for logical volume, then press **ENT** for two seconds to proceed. "LV" is short for Logical Volume.

```
LV=0
Not Defined   ?
```

Proceed to select one or more logical drives. Press **ENT** to proceed. "LD" is short for Logical Drive.

```
LV=0 Selected To
Select LD Drives?
```

Use the up or down arrow keys to browse through the logical drives. Press **ENT** again to select/deselect the drives. An asterisk (*) mark will appear when the logical drive is selected. After all the desired logical drive(s) have been selected, press **ENT** for two seconds to continue.

```
LG0 RAID5 DRV=3
2021MB GD SB=0
```

Two submenus will appear.

Initialization Mode

Array initialization can take a long time especially for those comprised of large capacity. Setting to "Online" means the array is immediately accessible and that the controller will complete the initialization when I/O demands become less intensive.

```
Initialization
Mode      Online..
```

Write Policy

This menu allows you to set the caching mode policy for this specific logical volume. "Default" is a neutral value that is coordinated with the controller's caching mode setting. Other choices are "Write-back" and "Write-through."

```
Write Policy
Default    ..
```

When you are finished setting the preferences, press **ENT** for two seconds to display the confirm box. Press **ENT** for two seconds to start initializing the logical volume.

```
Create
Logical Volume ?
```

The logical volume has been successfully created.

```
Lv=0 Creation
Completed
```

Press **ESC** to clear the message. Another message will prompt; press **ESC** to clear it.

```
Lv=0 ID=07548332
0024488MB DRV=2
```

Logical volume information will be displayed below.

```
Create Logical
Volume Succeeded
```

Logical Volume Assignment

If you have two controllers, you may choose to assign this logical volume to the secondary controller. The assignment can be done during or after the initial configuration.

```
Change Logical
Volume Params ?
```

```
Logical Volume
Assignments ..
```

If the redundant controller function has been enabled, and the secondary controller IDs have been assigned to I/O channels, the assignment menus should appear as listed on the right.

```
Red Ctlr Assign
to Sec. Ctlr ?
```

If settings related to redundant controllers have not been completed, you may set them after the volume is successfully created.

```
Logical Volume
Assignment ..
```

Press **ENT** on a configured logical volume. Use arrow keys to select “Logical Volume Assignment..”, and press **ENT** to proceed. Press **ENT** for two seconds to confirm.

```
Red Ctlr Assign
to Sec. Ctlr ?
```

Press **ESC**, and the LCD will display the logical volume's information when initialization is finished.

```
LV=0 ID=685AE502
2021MB DRV=1
```

5.6 Partitioning a Logical Drive/Logical Volume

Partitioning and the creation of a logical volume, are not requirements for creating a RAID system. The configuration processes for partitioning a logical drive are the same as those for partitioning a logical volume.

IMPORTANT!

- If operated with a Unix-based system, reset the subsystem for the configuration to take effect if any changes have been made to partition sizes and partition arrangement.*

Press **ENT** for two seconds to enter the Main Menu. Press the up or down arrow keys to select "View and Edit Logical Volume," then press **ENT**.

```
View and Edit
Logical Volume .
```

Press the up or down arrow keys to select a logical volume, then press **ENT**.

```
LV=0 ID=685AE502
2021MB DRV=1
```

Press the up or down arrow keys to select "Partition Logical Volume," then press **ENT**.

```
Partition
Logical Volume..
```

The total capacity of the logical volume will be displayed as the first partition (partition 0). Press **ENT** for two seconds to change the size of the first partition.

```
LV=0 Part=0:
      2021MB ?
```

Use the up or down arrow keys to change the number of the flashing digit, (see the arrow mark) then press **ENT** to move to the next digit. After changing all the digits, press **ENT** for two seconds to confirm the capacity of this partition. You may also use arrow keys to move down to the next partition.

```
LV=0 Part=0:
  2021MB
  ↑
```

```
LV=0 Part=0:
      700MB ?
```

The rest of the drive space will be automatically allocated as the last partition. You may go on to create up to 32 partitions using the same method as described above.

```
LV=0 Partition=1
      1321MB ?
```

Press **ESC** several times to go back to the Main Menu.

5.7 Mapping a Logical Volume/Logical Drive to Host LUN

The process of mapping a logical drive is identical to that of mapping a logical volume. The process of mapping a logical volume is used as an example.

Press **ENT** for two seconds to enter the Main Menu. Press the up or down arrow keys to select "View and Edit Host Luns," then press **ENT**.

```
View and Edit
Host Luns
```

Note some details before proceeding:

1. **Primary/Secondary IDs:** A logical group of drives (logical drive/logical volume) previously assigned to the primary controller cannot be mapped to a secondary ID. Neither can those be assigned to the secondary controller be mapped to a primary ID.
2. **Reserved IDs:** For a SCSI-based controller, ID 7 is reserved for the controller itself. If there are two controllers, controllers might occupy ID 6 and ID 7. Please check your system *hardware manual* for details on preserved IDs.

Press the up or down arrow keys to select a configured host ID, and then press **ENT** for two seconds to confirm. IDs are available as Primary or Secondary Controller IDs.

```
CH=0 ID=000
Pri. Ctlr ..
```

Press the up or down arrow keys to select the type of logical configuration. Available choices are "Map to Logical Volume," "Map to Logical Drive," or "Map to Physical Drive." Confirm your choice by pressing **ENT**.

```
Map to
Logical Volume ?
```

Press the up or down arrow keys to select a LUN number, then press **ENT** to proceed.

```
CH=0 ID=0 LUN=0
Not Mapped
```

Press **ENT** for two seconds to confirm the selected LUN mapping.

```
Map Host LUN ?
```

Press the up or down arrow keys to select a partition from the logical volume. Press **ENT** for two seconds to

```
LV=0 ID=685AE502
2021MB DRV=1
```

map the selected partition to this LUN. If the logical configuration has not been partitioned, you can map the whole capacity to a host LUN.

```
LV=0 PART=0
700MB      ?
```

Mapping information will be displayed on the subsequent screen. Press **ENT** for two seconds to confirm the LUN mapping.

```
CH=0 ID0 LUN0
MAP to LV=0 PRT=0?
```

With any of the host ID/LUN successfully associated with a logical capacity, the "No Host LUN" message in the main menu will change to "Ready."

If you want to create more host IDs, please move to *Section 5.12 Viewing and Editing SCSI Channels* for more details on channel mode and channel IDs setting.

5.8 Assigning Spare Drive and Rebuild Settings

Adding a Local Spare Drive

Press **ENT** for two seconds to enter the Main Menu. Press the up or down arrow keys to select "View and Edit SCSI Drives," then press **ENT**.

```
View and Edit
SCSI Drives .
```

SCSI drive information will be displayed on the LCD. Press the up or down arrow keys to select a drive that is stated as "NEW DRV" or "USED DRV" that has not been assigned to any logical drive, nor as spare drive or failed drive, then press **ENT** to select it.

```
C=2 I=4 1010MB
NEW DRV SEAGATE
```

Press the up or down arrow keys to select "Add Local Spare Drive," then press **ENT**.

```
Add Local Spare
Drive ..
```

Press the up or down arrow keys to select the logical drive where the Local Spare Drive will be assigned, then press **ENT** for two seconds to confirm.

```
LG0 RAID5 DRV=3
2012MB GD SB=0
```

```
Add Local Spare
Drive Successful
```

The message "Add Local Spare Drive Successful" will be displayed on the LCD.

Adding a Global Spare Drive

Press ENT for two seconds to enter the Main Menu. Press the up or down arrow keys to select "View and Edit SCSI Drives," then press ENT.

```
View and Edit
SCSI Drives .
```

SCSI drive information will be displayed on the LCD. Press the up or down arrow keys to select a SCSI drive that has not been assigned to any logical drive yet, then press ENT.

```
C=2 I=4 1010MB
NEW DRV SEAGATE
```

```
Add Global Spare
Drive ..
```

Press the up or down arrow keys to select "Add Global Spare Drive," then press ENT.

Press ENT again for two seconds to add the spare drive. The message "Add Global Spare Drive Successful" will be displayed on the LCD.

```
Add Global Spare
Drive Successful
```

Rebuild Settings

Press ENT for two seconds to enter the Main Menu. Press the up or down arrow keys to select "View and Edit Config Parm's," then press ENT.

```
View and Edit
Config Parm's .
```

Press the up or down arrow keys to select "Disk Array Parameters," then press ENT.

```
Disk Array
Parameters..
```

Press the up or down arrow keys to select "Rebuild Priority Low," then press ENT. "Low" refers to the temporary setting.

```
Rebuild Priority
Low ..
```

Press ENT again and the abbreviation mark ".." will change to a question mark "?". Press the up or down arrow keys to select priority "Low," "Normal," "Improved," or "High".

```
Rebuild Priority
Low ?
```

Press **ENT** to confirm and the question mark “?” will turn into “..”.

```
Rebuild Priority
High ..
```

NOTE:

- *The rebuild priority determines how much of the controller resources are used when rebuilding a logical drive. The default setting of the rebuild priority is “LOW.” Rebuild will have less impact on host I/O access, but will take a longer time to complete. Changing the priority to a higher level will achieve a faster rebuild, but will significantly increase the host I/O response time. The default setting “LOW” is recommended.*
-

5.9 Viewing and Editing Logical Drives and Drive Members

Press **ENT** for two seconds to enter the Main Menu. Press the up or down arrow keys to select "View and Edit Logical Drives..," then press **ENT**.

```
View and Edit
Logical Drives .
```

Press the up or down arrow keys to select the logical drive, then press **ENT**.

```
LG0 RAID5 DRV=3
2012MB GD SB=1
```

Press the up or down arrow keys to select "View SCSI Drives..", then press **ENT**.

```
View SCSI Drives
..
```

Press the up or down arrow keys to scroll through the list of member drives.

```
C=1 I=0 1010MB
LG=0 LN SEAGATE
```

Deleting a Logical Drive

Press **ENT** for two seconds to enter the Main Menu. Press the up or down arrow keys to select "View and Edit Logical Drives," then press **ENT**.

```
View and Edit
Logical Drives .
```

```
LG0 RAID5 DRV=3
2012MB GD SB=1
```

Press the up or down arrow keys to select a logical drive, then press **ENT**.

```
Delete Logical
Drive ..
```

Press the up or down arrow keys to select "Delete Logical Drive," then press ENT.

Press ENT for two seconds to delete. The selected logical drive has now been deleted.

```
LG=0
Not Defined ?
```

Deleting a Partition of a Logical Drive

Press ENT for two seconds to enter the Main Menu. Press the up or down arrow keys to select "View and Edit Logical Drives.," then press ENT.

```
View and Edit
Logical Drives .
```

Press the up or down arrow keys to select a logical drive, then press ENT.

```
LG0 RAID5 DRV=3
2012MB GD SB=1
```

Press the up or down arrow keys to choose "Partition Logical Drive," then press ENT.

```
Partition
Logical Drive ..
```

The first partition's information will be shown on the LCD. Press the up or down arrow keys to browse through the existing partitions in the logical drive. Select a partition by pressing ENT for two seconds.

```
LG=0 Partition=1
200MB ?
```

```
LG=0 Partition=1
300MB ?
```

Use the up or down arrow keys to change the number of the flashing digit to "0," then press ENT to move to the next digit. After changing all the digits, press ENT for two seconds.

```
LG=0 Partition=2
600MB ?
```

The rest of the drive space will be automatically allocated to the last partition as diagrammed below.

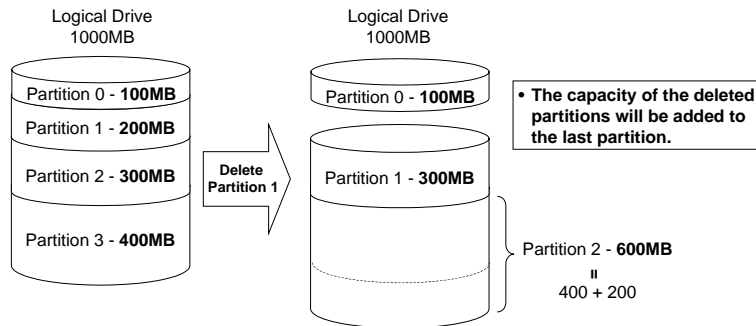

Figure 5 - 1 Drive Space Allocated to the Last Partition

WARNING!

- *Whenever there is a partition change, data will be erased, and all host LUN mappings will be removed. Therefore, every time the size of a partition has been changed, it is necessary to reconfigure all host LUN mappings of the associated partitions.*
-

Assigning a Name to a Logical Drive

Press **ENT** for two seconds to enter the Main Menu. Press the up or down arrow keys to select "View and Edit Logical Drives..," then press **ENT**.

```
View and Edit
Logical Drives .
```

Press the up or down arrow keys to select a logical drive, then press **ENT**.

```
LG0 RAID5 DRV=3
2012MB GD SB=1
```

Press the up or down arrow keys to select "Logical Drive Name," then press **ENT**.

```
Logical Drive
Name ..
```

Press the up or down arrow keys to change the character of the flashing cursor. Press **ENT** to move the cursor to the next space. The maximum number of characters for a logical drive name is 25.

```
Enter LD Name:
_
```

Rebuilding a Logical Drive

If you want the controller to auto-detect a replacement drive, make sure you have the following items set to enabled:

1. Periodic Drive Check Time
2. Periodic Auto-Detect Failure Drive Swap Check Time

These two configuration options can be found under "View and Edit Configuration Parameters" -> "Drive-Side SCSI Parameters".

Press **ENT** for two seconds to enter the Main Menu. Press the up or down arrow

```
View and Edit
Logical Drives .
```

keys to select "View and Edit Logical Drives.", then press ENT.

Press the up or down arrow keys to select the logical drive that has a failed member, then press ENT.

```
LG0 RAID5 DRV=3
2012MB FL SB=0
```

Press the up or down arrow keys to select "Rebuild Logical Drive," then press ENT.

```
Rebuild Logical
Drive ..
```

Press ENT for two seconds to start rebuilding the logical drive.

```
Rebuild Logical
Drive ?
```

The rebuilding progress will be displayed (as a percentage) on the LCD. When rebuilding is already started or the logical drive is being rebuilt by a Local Spare Drive or Global Spare Drive, choose "Rebuild Progress" to see the rebuild progress.

```
LG0 RAID5 DRV=3
2012MB RB SB=0
```

```
Rebuilding 25%
Please Wait!
```

```
Rebuild Progress
..
```

IMPORTANT!

- *The Rebuild function will appear only if a logical drive (with RAID level 1, 3 or 5) has a failed member.*
 - *Use the "Identify Drive" function to check the exact location of a failed drive. Removing the wrong drive may cause a logical drive to fail and data loss is unrecoverable.*
-

Regenerating Logical Drive Parity

If no verifying method is applied to data writes, this function can be manually performed to ensure that parity errors can be mended.

From the Main Menu, press the up or down arrow keys to select "View and Edit Logical Drives."

```
View and Edit
Logical Drives
```

If you have more than one logical drive, use the up or down arrow keys to select the logical drive you would like to check the parity for, and then press ENT.

```
LG0 RAID5 DRV=3
4095MB GD SB=0
```

```
Regenerate
Parity ..
```

Press the up or down arrow keys to select "Regenerate Parity" and then press ENT.

To stop the regeneration process, press ESC and enter the submenu to select "Abort Regenerate Parity".

```
Abort Regenerate
Parity          ..
```

IMPORTANT!

- *If the Parity Regenerating process is stopped by a drive failure, the process cannot restart until the logical drive is rebuilt.*
-

Media Scan

Media Scan is used to examine drives and detect the presence of bad blocks. If any data blocks have not been properly committed, data from those blocks are automatically recalculated, retrieved, and stored onto undamaged sectors. If bad blocks are encountered on yet another drive during the rebuild process, the block LBA (Logical Block Address) of those bad blocks will be shown. If rebuild is carried out in this situation, rebuild will continue with the unaffected sectors, salvaging a majority of the stored data.

From the Main Menu, press the up or down arrow keys to select "View and Edit Logical Drives".

```
View and Edit
Logical Drives
```

The first logical drive displays. If you have more than one logical drive, use the up or down keys to select the logical drive you want to scan, and then press ENT.

```
LG0 RAID5 DRV=3
4095MB GD SB=0
```

Press the up or down arrow keys to select "Media Scan" and then press ENT.

```
Media Scan
..
```

Press ENT again to display the first configuration option, "Priority." Press ENT on it and use arrow keys to select an option. Press ENT to confirm the change on priority level.

```
Priority
Normal ..
```

```
Priority
To High ?
```

Use arrow keys to move one level down to another option, "Iteration Count". This option determines how many times the scan is performed on the logical

```
Iteration Count
Single ..
```

```
Iteration Count
to Continuous ?
```

drive. If set to "Continuous," the scan will run in the background continuously until it is stopped by user.

If Media Scan is continuously run in the background, considerable system resources will be consumed.

Press ENT on your option to confirm.

Press ENT for two seconds to display the confirm message, then press ENT to start scanning the array.

```
Execute Media
Scanning      ?
```

Write Policy

From the Main Menu, press the up or down arrow keys to select "View and Edit Logical Drives".

```
View and Edit
Logical Drives
```

The first logical drive displays. If you have more than one logical drive, use the τ or σ keys to select the logical drive you want to change the write policy of; and then press ENT.

```
LG0 RAID5 DRV=3
4095MB GD SB=0
```

Use arrow keys to select "Write Policy" and then press ENT.

```
Write Policy
..
```

The Write-Back cache setting is configurable on a per array basis. Setting to the default value means the array setting is coordinated with the controller's general setting. The controller's general setting option can be found in "View and Edit Config Params" -> "Caching Parameters" -> "Write-Back Cache". Note that cached writes are lost if a power failure occurs unless cached data has been duplicated to a partner controller and a battery is supporting cache memory.

```
Write Policy
Write-Back    ?
```

5.10 Viewing and Editing Host LUNs

Viewing and Deleting LUN Mappings

Press **ENT** for two seconds to enter the Main Menu. Press the up or down arrow keys to select "View and Edit Host Luns", then press **ENT**.

```
View and Edit
Host Luns .
```

Press the up or down arrow keys to select a host ID, then press **ENT** to proceed.

```
CH=0 ID=002
Sec. Ctlr ..
```

Press the up or down arrow keys to browse through the LUN number and its LUN mapping information.

```
CH=0 ID=0 LUN=0
Mapto LG0 PRT0
```

Press **ENT** on the LUN you wish to delete.

```
Delete CH0 ID0
LUN=00 Mapping ?
```

Press **ENT** for two seconds to confirm deletion. The deleted LUN has now been unmapped.

```
CH=0 ID=0 LUN=0
Not Mapped
```

For LUN Filtering functions, e.g., Create Host Filter Entry, Edit Host-ID/WWN Name List, please refer to *Chapter 8 "Fibre Operation."*

Pass-through SCSI Commands

Pass-through SCSI commands facilitate functions like downloading firmware for drives or devices (not controller firmware), setting SCSI drive mode parameters, or monitoring a SAF-TE/S.E.S. device directly from the host. To perform such a function, the channel device must be mapped to a host ID.

From the Main Menu, press the up or down arrow keys to select "View and Edit Host LUNs."

```
View and Edit
Host Luns
```

If you have primary and secondary controllers, use the up or down keys to select the controller for the device that you would like to map.

```
Map Channel=0
ID=0 Pri Ctlr ?
```

Press the up or down arrow keys to choose to map an ID to "Physical Drive" or other device, and then press ENT.

```
Map to
Physical Drive ?
```

WARNING!

- *Pass-through SCSI Commands are only intended to perform maintenance functions for a drive or device on the drive side. Do not perform any destructive commands to a disk drive (i.e., any commands that write data to a drive media). If a disk drive is a spare drive or a member of a logical drive, such a destructive command may cause a data inconsistency.*
- *When a drive/device is mapped to a host SCSI ID so that Pass-through SCSI Commands can be used, the data on that drive/device will not be protected by the controller. Users who employ Pass-through SCSI Commands to perform any write commands to drive media do so at their own risk.*

5.11 Viewing and Editing SCSI Drives

Scanning a New SCSI Drive

Press ENT for two seconds to enter the Main Menu. Press the up or down arrow keys to select "View and Edit SCSI Drives," then press ENT.

```
View and Edit
SCSI Drives .
```

SCSI drive information will be displayed on the LCD. Press ENT on a drive. Use the up or down arrow keys to select "Scan New SCSI Drive," then press ENT again.

```
Scan new SCSI
Drive ..
```

Press the up or down arrow keys to select a SCSI channel, then press ENT for two seconds.

```
Scan Channel=1 ?
```

Press the up or down arrow keys to select a SCSI ID, then press ENT for two seconds.

```
Scan Channel=1
ID= 01 ?
```

The information of the scanned SCSI drive will be displayed on the LCD. If the drive was not detected on the selected SCSI channel and ID, the LCD will display "Scan Fail!"

```
Scan Channel=1
ID=1 Scan Fail!
```

An empty drive entry is added for this channel/SCSI ID for enclosure management. The drive status is "ABSENT."

```
C=1 I=1 ABSENT
```

To clear the empty drive entry, press ENT and use arrow keys to select "Clear Drive Status," then press ENT to proceed.

```
Clear Drive
Status ..
```

Press ENT for two seconds to confirm the drive entry's deletion. Information of other drives will be displayed instead.

```
Clear Drive
Status ?
```

Identifying a Drive

Press ENT for two seconds to enter the Main Menu. Press the up or down arrow keys to select "View and Edit SCSI Drives," then press ENT.

```
View and Edit
SCSI Drives .
```

SCSI drive information will be displayed. Press the up or down arrow keys to select a SCSI drive, then press ENT.

```
C=1 I=0 1010MB
GlobalSB SEAGATE
```

Press the up or down arrow keys to select "Identify Drive," then press ENT to continue.

```
Identify Drive
..
```

Press the up or down arrow keys to select "Flash All Drives", "Flash Selected Drive", or "Flash All But Selected Drive". Press ENT for two seconds to flash the read/write LEDs of all the connected drives.

```
Flash All
Drives ?
```

Or, press the up or down arrow keys to select "Flash Selected SCSI Drives," then press ENT for two seconds to flash the read/write LED of the selected drive. The read/write LED will light for a configurable time period from 1 to 999 seconds.

```
Flash Selected
SCSI Drives ?
```

```
Flash all But
Selected Drives?
```

Deleting Spare Drive (Global / Local Spare Drive)

Press ENT for two seconds to enter the Main Menu. Press the up or down arrow keys to select "View and Edit SCSI Drives," then press ENT.

```
View and Edit
SCSI Drives .
```

SCSI drive information will be displayed on the LCD. Press the up or down arrow keys to select the spare drive you wish to delete, then press ENT.

```
C=1 I=0 1010MB
GlobalSB SEAGATE
```

Press the up or down arrow keys to select "Delete Spare Drive," then press ENT to continue.

```
Delete Spare
Drive ..
```

Press ENT for two seconds to delete the spare drive.

```
Delete Spare
Drive Successful
```

5.12 Viewing and Editing SCSI Channels

Redefining Channel Mode

Press ENT for two seconds to enter the Main Menu. Press the up or down arrow keys to select "View and Edit SCSI Channels," then press ENT.

```
View and Edit
SCSI Channels .
```

Channel information will be displayed. Press the up or down arrow keys to browse through the information of all channels. Press ENT on the channel you wish the channel mode changed.

```
CH0=Host PID=0
SID=NA SXF=20.0M
```

Press the up or down arrow keys to select "Redefine Channel Mode," then press ENT.

```
Redefine Channel
Mode ..
```

Press ENT for two seconds to change the channel mode.

```
Redefine? CHL=0
To=Drive Channel
```

```
CH0=Drive PID=7
SID=NA SXF=20.8M
```

The new setting will be displayed.

IMPORTANT!

- *Every time you change a channel mode, you must reset the controller for the changes to take effect.*
-

Setting a SCSI Channel's ID - Host Channel

Viewing IDs

Press **ENT** for two seconds to enter the Main Menu. Press the up or down arrow keys to select "View and Edit SCSI Channels," then press **ENT**.

```
View and Edit
SCSI Channels  .
```

Channel information will be displayed. Press **ENT** on the host channel you wish the ID changed.

```
CH0=Host  PID=0
SID=NA  SXF=20.0M
```

Press the up or down arrow keys to select "Set SCSI Channel ID," then press **ENT**.

```
Set SCSI Channel
ID                ..
```

Press the up or down arrow keys to browse through the existing ID settings. Press **ENT** on any ID combination to continue.

```
CHL=0  ID=0
Primary Ctrl  ..
```

Adding a Channel ID

Press **ENT** on a host channel, on "Set SCSI Channel ID", and then on an existing ID.

Press the up or down arrow keys to choose "Add Channel SCSI ID", then press **ENT**.

```
Add Channel
SCSI ID      ..
```

Press the up or down arrow keys to choose "Primary Controller" or "Secondary Controller", then press **ENT** for two seconds to confirm.

```
Primary
Controller   ?
```

Press the up or down arrow keys to choose the SCSI ID you wish to add, then press **ENT** for two seconds to complete the process.

```
Add CHL=0 ID=2
Primary Ctlr  ?
```

Deleting a Channel ID

Press **ENT** on the existing host channel ID you want to delete. Press the up or down arrow keys to choose "Delete Channel SCSI ID," then press **ENT**.

```
Delete Channel
SCSI ID      ..
```

Press **ENT** for two seconds to confirm.

```
Delete ID=2
Primary Ctlr  ?
```

IMPORTANT!

- *Every time you make changes to channel IDs, you must reset the controller for the configuration to take effect.*
- *The reserved IDs for SCSI-based controllers are shown below:
Single controller configuration (SCSI-based controllers):
Drive channels – "7"
Redundant controller configuration:
Drive channels – "8" and "9"*

For IDs reserved in different controller/subsystem configurations, please refer to the hardware manual that came with your system. For controllers connected through back-end PCBs, firmware can detect their board types and automatically apply the preset IDs. There is no need to set IDs for these models.

- *In single controller mode, you should set the Secondary Controller's ID to "NA." If a secondary controller exists, you need to set an ID for it on each of your drive channels.*
- *Multiple target IDs can be applied to host channels while each drive channel has only one or two IDs (in redundant mode).*
- *At least one controller's ID has to be present on each channel bus.*

Setting a SCSI Channel's Primary ID - Drive Channel

Press **ENT** for two seconds to enter the Main Menu. Press the up or down

```
View and Edit
SCSI Channels .
```

arrow keys to select "View and Edit SCSI Channels," then press ENT.

Channel information will be displayed. Press ENT on the drive channel for which you wish the ID changed.

```
CH1=Drive  PID=7  
SID=NA  SXF=80.0M
```

Press the up or down arrow keys to select "Set SCSI Channel Pri. Ctlr ID..", then press ENT.

```
Set SCSI Channel  
Pri. Ctlr ID  ..
```

Press the up or down arrow keys to select a new ID, then press ENT for two seconds to confirm.

```
Set Pri. Ctlr  
ID= 7 to ID: 8 ?
```

Setting a SCSI Channel's Secondary ID - Drive Channel

Press ENT for two seconds to enter the Main Menu. Press the up or down arrow keys to select "View and Edit SCSI Channels," then press ENT.

```
View and Edit  
SCSI Channels  .
```

Channel information will be displayed. Press ENT on the drive channel for which you wish the ID changed.

```
CH1=Drive  PID=7  
SID=NA  SXF=20.0M
```

Press the up or down arrow keys to select "Set SCSI Channel Sec. Ctlr ID..", then press ENT.

```
Set SCSI Channel  
Sec. Ctlr ID  ..
```

Press the up or down arrow keys to select a new ID, then press ENT for two seconds to confirm.

```
Set Sec. Ctlr  
ID=NA to ID: 9 ?
```

Setting the Channel Bus Terminator

Press ENT for two seconds to enter the Main Menu. Press the up or down arrow keys to select "View and Edit SCSI Channels," then press ENT.

```
View and Edit  
SCSI Channels  .
```

Channel information will be displayed. Press the up or down arrow keys to select a channel. Press ENT on the

```
CH0=Host  PID=0  
SID=NA  SXF=20.0M
```

```
Set SCSI Channel  
Terminator  ..
```

channel for which you wish the terminator mode changed.

Press the up or down arrow keys to select "Set SCSI Channel Terminator," then press ENT.

Its current status will be displayed on the LCD. Press ENT to continue.

```
SCSI Terminator
Enabled      ..
```

Press ENT again for two seconds to change the terminator mode to the alternate setting.

```
CHL=0 Disable
Terminator   ?
```

IMPORTANT!

- You can use the terminator jumpers on the controller board to control SCSI bus termination of the SentinelRAID series controllers. When using jumpers to control, the firmware termination setting must be disabled. To disable SCSI termination of a SCSI bus, the associated terminator jumpers must be left open, and the firmware setting must be disabled.

Setting Transfer Speed

IMPORTANT!

Transfer rate	Transfer speed in Mhz
SCSI-320	160Mhz
SCSI-160	80Mhz

- According to SCSI Channel Specifications, transfer speed shown in Mhz is the SCSI bus sync frequency. With 16-bit Wide transfer, the actual data rate is the double of Mhz transfer speed.

- Every time you change the Transfer Speed, you must reset the controller for the changes to take effect.

Transfer speed refers to the SCSI bus speed in synchronous mode. Asynchronous mode is also available in this option setting. In Ultra/Ultra Wide SCSI, the maximum synchronous speed is 160MHz.

Press ENT for two seconds to enter the Main Menu. Press the up or down arrow keys to select "View and Edit SCSI Channels," then press ENT.

```
View and Edit
SCSI Channels .
```

Channel information will be displayed. Press the up or down arrow keys to

```
CH0=Host  PID=0
SID=NA  SXF=80.0M
```

select a channel. Press **ENT** on the channel for which you wish the transfer speed changed.

Press the up or down arrow keys to select "Set Transfer Speed," then press **ENT**.

```
Set Transfer
Speed      ..
```

The current speed of this SCSI channel will be displayed. Press the up or down arrow keys to select the desired speed, then press **ENT** for two seconds to confirm.

```
CHL=0 Clk=80.0M
Change to=40.0M?
```

Setting Transfer Width

The controller supports 8-bit SCSI and 16-bit SCSI. Enable "Wide Transfer" to use the 16-bit SCSI function. Disabling "Wide Transfer" will limit the channel transfer speed to 8-bit SCSI.

Press **ENT** for two seconds to enter the Main Menu. Press the up or down arrow keys to select "View and Edit SCSI Channels," then press **ENT**.

```
View and Edit
SCSI Channels .
```

Channel information will be displayed. Press the up or down arrow keys to browse through the channels. Press **ENT** on the channel for which you wish the transfer width changed.

```
CH0=Host PID=0
SID=NA SXF=20.0M
```

Press the up or down arrow keys to select "Set Transfer Width," then press **ENT**.

```
Set Transfer
Width      ..
```

The current mode will be displayed. Press **ENT** to continue.

```
Wide Transfer
Enabled    ..
```

Press **ENT** again for two seconds.

```
Disable
Wide Transfer ?
```

IMPORTANT!

- *Every time you change the SCSI Transfer Width, you must reset the controller/subsystem for the changes to take effect.*
-

Viewing and Editing a SCSI Target - Drive Channel

Press **ENT** for two seconds to enter the Main Menu. Press the up or down arrow keys to select "View and Edit SCSI Channels," then press **ENT**.

```
View and Edit
SCSI Channels .
```

SCSI channel information will be displayed on the LCD. Press **ENT** on the drive channel for which you wish the SCSI ID changed.

```
CH1=Drive PID=7
SID=NA SXF=20.0M
```

Press the up or down arrow keys to select "View and Edit SCSI Target," then press **ENT**.

```
View and Edit
SCSI Target ..
```

Press up or down arrow keys to select a SCSI target, then press **ENT**.

```
SCSI Target
CHL=1 ID=0 ..
```

Slot Number

To set the Slot number of the SCSI target, choose "Slot Assignment," then press **ENT**. The current slot number will be displayed.

```
Slot Assignment
Default No Set..
```

Press the up or down arrow keys to change the slot number, then press **ENT** for two seconds.

```
Slot Assignment
Set to # 9 ?
```

Maximum Synchronous Transfer Clock

Press the up or down arrow keys to select a SCSI target, then press **ENT**.

```
SCSI Target
CHL=1 ID=0 ..
```

To set the maximum synchronous clock of this SCSI target, choose "Max. Synchronous Xfer Clock," then press **ENT**. The current clock setting will be displayed on the LCD.

```
Max Synchronous
Xfer Clock# 12..
```

Press the up or down arrow keys to change the clock, then press **ENT** for two seconds.

```
Period   Factor
Def= 12 to  ??
```

Maximum Transfer Width

Press the up or down arrow keys to select a SCSI target, then press **ENT**.

```
SCSI Target
CHL=1 ID=0  ..
```

To set the maximum transfer width of this SCSI target, choose "Max. Xfer Narrow Only" or "Max. Xfer Wide Supported," then press **ENT**. The current clock setting will be displayed on the LCD.

```
Max Xfer Wide
Supported    ..
```

Press **ENT** for two seconds to change the setting.

```
Max Xfer Narrow
Only         ?
```

Parity Check

Press the up or down arrow keys to select a SCSI target, then press **ENT**.

```
SCSI Target
CHL=1 ID=0  ..
```

Choose "Parity Check," then press **ENT**. The current clock setting will be displayed on the LCD.

```
Parity Check
Enabled     ..
```

Press **ENT** for two seconds to change the setting.

```
Disable
Parity Checking?
```

Disconnecting Support

Press the up or down arrow keys to select a SCSI target, then press **ENT**.

```
SCSI Target
CHL=1 ID=0  ..
```

Choose "Disconnect Support," then press **ENT**. The current clock setting will be displayed on the LCD.

```
Disconnect
Support Enabled
```

Press **ENT** for two seconds to change the setting.

```
Disable Support
Disconnect    ?
```

Maximum Tag Count

Press the up or down arrow keys to select a SCSI target, then press **ENT**.

```
SCSI Target  
CHL=1 ID=0 ..
```

Choose "Max Tag Count," then press **ENT**. The current clock setting will be displayed on the LCD.

```
Max Tag Count:  
Default( 32) ..
```

Press the up or down arrow keys to change the setting, then press **ENT** for two seconds to change the setting.

```
Tag Cur=32  
Set to:Default ?
```

IMPORTANT!

- *Disabling the Maximum Tag Count will disable the internal cache of this SCSI drive..*
-

Restore to Default Setting

Press the up or down arrow keys to select a SCSI target, then press **ENT**.

```
SCSI Target  
CHL=1 ID=0 ..
```

Choose "Restore to Default Setting," then press **ENT**.

```
Restore to  
Default Setting.
```

Press **ENT** again for two seconds to restore the SCSI target's default settings.

```
Restore to  
Default Setting?
```

Data Rate

This option is available in the configuration menu of Fibre host channel and the drive channel configuration menus of Fibre-, ATA-, or SATA-based subsystems. Default is "AUTO" and should work fine with most drives. Changing this setting is not recommended unless some particular bus signal issues occur.

The host channel data rate setting allows a 2Gbit Fibre Channel to negotiate with devices communicating over 1GHz link if the link speed configuration is determined externally.

Most SATA/ATA-based systems connect only one drive per SATA/ATA channel (4 for multi-lane with SATA-II). This helps to avoid a single drive failure from affecting other drives. The maximum mechanical performance of today's drives can reach around 30MB/second (sustained read). This is still far below the bandwidth of a drive channel bus. Setting the SATA/ATA bus speed to a lower value can get around some problems, but will not become a bottleneck to system performance.

Note that the SATA/ATA speed is the maximum transfer rate of the SATA/ATA bus in that mode. It does not mean the drive can actually carry out that amount of sustained read/write performance. For the performance of each drive model, please refer to the documentation provided by drive manufacturer.

Host Channel:

Select from Main Menu, "View and Edit Channels," and then a host channel you wish to change its data rate. Press **ENT** on the channel and use the arrow keys to find the "Data Rate" option. Press **ENT** on the Data Rate option to display "Set Chl=X Data Rate To AUTO?", where "X" stands for the channel number.

```
C0=Host PID=102
SID=NA SXF=AUTO
```

```
Data Rate ..
```

```
Set Chl=X Data
Rate To AUTO ?
```

Use your arrow keys to display a different data rate (1GHz or 2GHz). Press **ENT** to confirm a selection.

Drive Channel:

Select from Main Menu, "View and Edit Channels," and then a drive channel you wish to change its data rate. Press **ENT** on the channel and use the arrow keys to find the "Data Rate" option. Press **ENT** on the Data Rate option to display "Set Chl=X Data Rate To AUTO?", where "X" stands for the channel number.

```
CHX=Drive PID=7
SID=8 SXF=AUTO
```

```
View Chip
Information ..
```

```
Data Rate ..
```

```
Set Chl=X Data
Rate to AUTO ?
```

Use your arrow keys to display a data rate value which ranges from 33 to 150MB/s (SATA drive channels). Press **ENT** to confirm a selection.

Issue LIP

This option allows you to manually issue a LIP (Loop Initialization Sequence) on either a host or drive channel. This function is particularly useful when cabling failure occurs between two cascaded drive enclosures.

The condition for applying the “Issue LIP” function is described as follows (see diagram Figure 5-1):

1. Multiple enclosures have been cascaded using FC-AL Fibre links. For example, an EonRAID 2510FS or an A16F-R RAID enclosure connected with several SATA JBODs.
2. One cable link fails between drive enclosures or is disconnected.
3. Cabling failure is restored.
4. Since the FC port to which the failed link was attached to has already been bypassed at the time when the fault occurred, a LIP command must be manually exerted by the user for the FC port to participate in the loop again. The dual-loop FC-AL can thus be restored.

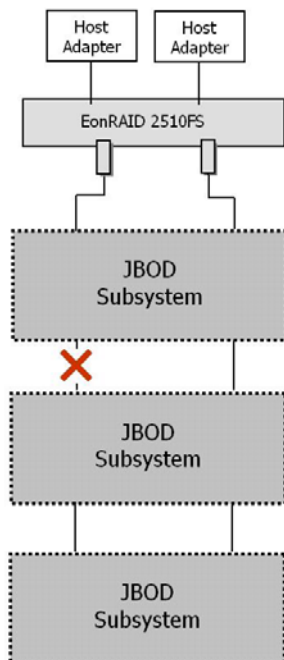

Figure 5 - 2 Cabling Failure between Drive Enclosures

Select from under, “View and Edit Channels,” and then a host or drive channel over which you wish to issue a

Issue LIP ?

LIP command. Press ENT on the channel and use the arrow keys to display the "Issue LIP" command. Press ENT to exert the command.

```
Issue LIP ..
```

5.13 System Functions

Choose "System Functions" in the Main Menu, then press ENT. Press the up or down arrow keys to select a submenu, then press ENT.

Mute Beeper

When the controller's beeper has been activated, choose "Mute Beeper," then press ENT to turn the beeper off temporarily for the current event. The beeper will still activate on the next event.

```
Mute Beeper ..
```

Change Password

Use the controller's password to protect the system from unauthorized entry. Once the controller's password is set, regardless of whether the front panel, the RS-232C terminal interface or the RAIDWatch Manager is used, the user can only configure and monitor the RAID controller by providing the correct password.

IMPORTANT!

- *The controller requests a password whenever a user is entering the main menu from the initial screen or a configuration change is made. If the controller is going to be left unattended, the "Password Validation Timeout" should be set to "Always Check."*
- *The controller password and controller name share a 16-character space. The maximum number of characters for a controller password is 15. If 15*

characters are used for a controller name, there will be only one character left for the controller password and vice versa.

Changing Password

To set or change the controller password, press the up or down arrow keys to select "Change Password," then press ENT.

```
Change Password
                ..
```

If the password has previously been set, the controller will ask for the old password first. If password has not yet been set, the controller will directly ask for the new password. The password cannot be replaced unless the correct old password is provided.

```
Old Password
                ..
```

Press the up or down arrow keys to select a character, then press ENT to move to the next space. After entering all the characters (alphabetic or numeric), press ENT for two seconds to confirm. If the password is correct, or there is no preset password, it will ask for the new password. Enter the password again to confirm.

```
Re-Ent Password
                ..
```

```
Change Password
Successful
```

Disabling Password

To disable or delete the password, press ENT on the first flashing digit for two seconds when requested to enter a new password. The existing password will be deleted. No password checking will occur when entering the Main Menu from the initial terminal screen or making configuration.

Reset Controller

To reset the controller without powering off the system, Press the up or down arrow keys to "Reset Controller," then press ENT. Press ENT again for two seconds to confirm. The controller will now reset.

```
Reset This
Controller  ..
```

```
Reset This
Controller  ?
```

Shutdown Controller

Before powering off the controller, unwritten data may still reside in cache memory. Use the “Shutdown Controller” function to flush the cache content. Press the up or down arrow keys to “Shutdown Controller,” then press ENT. Press ENT again for two seconds to confirm.

```
Shutdown This  
Controller ..
```

```
Shutdown This  
Controller ?
```

The controller will now flush the cache memory. Press ENT for two seconds to confirm and reset the controller or power off the controller.

```
ShutdownComplete  
Reset Ctlr?
```

Controller Maintenance

For Controller Maintenance functions, please refer to *Appendix C*.

Saving NVRAM to Disks

You can choose to backup your controller-dependent configuration information to disk. We strongly recommend using this function to save the configuration profile whenever a configuration change is made. The information will be distributed to every logical drive in the RAID system. If using the RAIDWatch manager, you can save your configuration data as a file to a computer system drive.

A RAID configuration of drives must exist for the controller to write NVRAM content onto it.

From the Main Menu, choose “System Functions.” Use arrow keys to scroll down and select “Controller Maintenance,” “Save NVRAM to Disks,” then press ENT. Press ENT for two seconds on the message prompt, “Save NVRAM to Disks?”.

```
Controller  
Maintenance ..
```

```
Save NVRAM  
To Disks ?
```

A prompt will inform you that NVRAM information has been successfully saved.

Restore NVRAM from Disks

If you want to restore your NVRAM information that was previously saved onto the array, use this function to restore the configuration setting.

From the Main Menu, choose “System Functions.” Use arrow keys to scroll down and select “Controller Maintenance,” “Restore NVRAM from Disks..,” and then press **ENT**. Press **ENT** for two seconds to confirm.

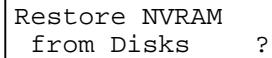

```
Restore NVRAM
from Disks   ?
```

A prompt will inform you that the controller NVRAM data has been successfully restored from disks.

Adjust LCD Contrast

The controller LCD contrast is set at the factory to a level that should be generally acceptable. The controller is equipped with an LCD contrast adjustment circuit in case the factory-preset level needs to be adjusted either via the RS-232 Terminal Emulation menus or using the LCD keypad panel.

From the main menu, choose “View and Edit Peripheral Dev.” Press **ENT** on it, press arrow keys to scroll down, and select “Adjust LCD Contrast,” press **ENT** to proceed, and then use the arrow keys to find an optimal setting. Press **ESC** to return to the previous menu.

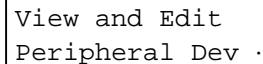

```
View and Edit
Peripheral Dev .
```

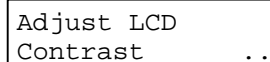

```
Adjust LCD
Contrast   ..
```

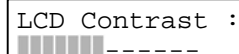

```
LCD Contrast :
■■■■■■■■-----
```

5.14 Controller Parameters

Controller Name

Select "View and Edit Config Parms" from the Main Menu. Choose "View and Edit Configuration Parameters," "Controller Parameters," then press **ENT**. The current name will be displayed. Press **ENT** for two seconds and enter the new controller name by using the up or down arrow keys. Press **ENT** to move to another character and then press **ENT** for two seconds on the last digit of the controller name to complete the process.

Controller Name:

Enter Ctrl Name:

LCD Title Display Controller Name

Choose "View and Edit Configuration Parameters," "Controller Parameters," then press **ENT**. Use the up or down arrow keys to choose to display the embedded controller logo or any given name on the LCD initial screen.

LCD Title Disp -
Controller Logo?

LCD Title Disp -
Controller Name?

Password Validation Timeout

Choose "View and Edit Configuration Parameters," "Controller Parameters," then press **ENT**. Select "Password Validation Timeout," and press **ENT**. Press the up or down arrow keys to choose to enable a validation timeout from one to five minutes to Always Check. The Always Check timeout will invalidate any configuration change without entering the correct password.

PasswdValidation
Timeout-5 mins..

Controller Unique Identifier

Choose "View and Edit Configuration Parameters," "Controller Parameters," then press **ENT**. Press the up or down arrow keys to select "Ctrl Unique ID-,"

Ctrl Unique
ID-

then press **ENT**. Enter any hex number between "0" and "FFFFFF" and press **ENT** to proceed.

Enter a unique ID for any RAID controller in a single or dual-controller configuration. The unique ID is recognized by the controller as the following:

1. A controller-specific identifier that helps controllers to identify its counterpart in a dual-active configuration.
2. The unique ID is combined to generate a unique WWN node name for controllers or RAID systems using Fibre Channel host ports. The unique node name helps prevent host computers from mis-addressing the storage system during controller failback/failover processes.
3. MAC addresses for the controller's Ethernet port that should be taken over by a surviving controller in the event of controller failure.

Controller Date and Time

This submenu is only available for controllers or subsystems that come with a real-time clock on board.

Time Zone

Choose "View and Edit Configuration Parameters," "Controller Parameters," then press **ENT**. Press the up or down arrow keys to scroll down and select "Set Controller Date and Time", then press **ENT**.

```
View and Edit  
Config Parm
```

```
Controller  
Parameters ..
```

```
Set Controller  
Date and Time ..
```

The controller uses GMT (Greenwich Mean Time), a 24-hours clock. To change the clock to your local time zone, enter the hours later than the Greenwich mean time after a plus (+) sign. For example, enter "+9" for Japanese time zone.

Choose "Time Zone" by pressing **ENT**.

Use the down key to enter the plus sign and the up key to enter numeric representatives.

```
Time Zone ..
```

```
GMT +08:00  
-
```

Date and Time

Use your arrow keys to scroll down and select "Date and Time" by pressing ENT.

```
Date and Time
..
```

Use the arrow keys to select and enter the numeric representatives in the following order: month, day, hour, minute, and the year.

```
[MMDDhhmm[YYYY]]
```

5.15 SCSI Drive Utilities

From the “View and Edit SCSI Drives” menu, select the drive that the utility is to be performed on; then press **ENT**. Select “SCSI Drive Utilities; then press **ENT**. Choose either “SCSI Drive Low-level Format” or “Read/Write Test”.

These options are not available for drives already configured in a logical configuration, and can only be performed before a reserved space is created on a drive.

```
View and Edit
SCSI Drives
```

```
C=1 I=1 8683MB
NEW DRV SEAGATE
```

```
SCSI Drives
Utilities ..
```

```
Drive Read/Write
Test ..
```

SCSI Drive Low-level Format

Choose “SCSI Drive Low-level Format” and confirm by selecting **Yes**.

```
Drive Low-Level
Format ..
```

IMPORTANT!

- *Do not switch the controller's and/or disk drive's power off during the Drive Low-level Format. If any power failure occurs during a drive low-level format, the formatting must be started over again when power resumes.*
 - *All of the data stored in the disk drive will be destroyed during a low-level format.*
 - *The disk drive on which a low-level disk format will be performed cannot be a spare drive (local or global) nor a member drive of a logical drive. The "SCSI Drive Low-level Format" option will not appear if the drive's status is not stated as a "New Drive" or a "Used Drive".*
-

SCSI Drive Read/Write Test

From the “View and Edit SCSI Drives” menu, select a new or used drive that

```
Drive Read/Write
Test ..
```

the utility is to be performed on; then press **ENT**. Select "SCSI Drive Utilities;" then press **ENT**. Choose "Read/Write Test" and press **ENT**.

```
Auto Reassign
Disabled    ..
```

Press the up or down arrow keys to select and choose to enable/disable the following options:

```
Abort When Error
Occur-Enabled
```

1. Auto Reassign Bad Block
2. Abort When Error Occurs
3. Drive Test for - Read Only/Read and Write.

When finished with configuration, select "Execute Drive Testing" and press **ENT** to proceed.

The Read/Write test progress will be indicated as a percentage.

```
Drv Testing 23%
Please Wait !
```

You may press **ESC** and select "Read/Write Test" later and press τ or σ to select to "View Read/Write Testing Progress" or to "List Current Bad Block Table." If you want to stop testing the drive, select "Abort Drive Testing" and press **ENT** to proceed.

```
View Read/Write
Test Progress ..
```

```
List Current
Bad Block Table.
```

```
Abort Read/Write
Testing    ..
```

Terminal Screen Messages

6.1 The Initial Screen

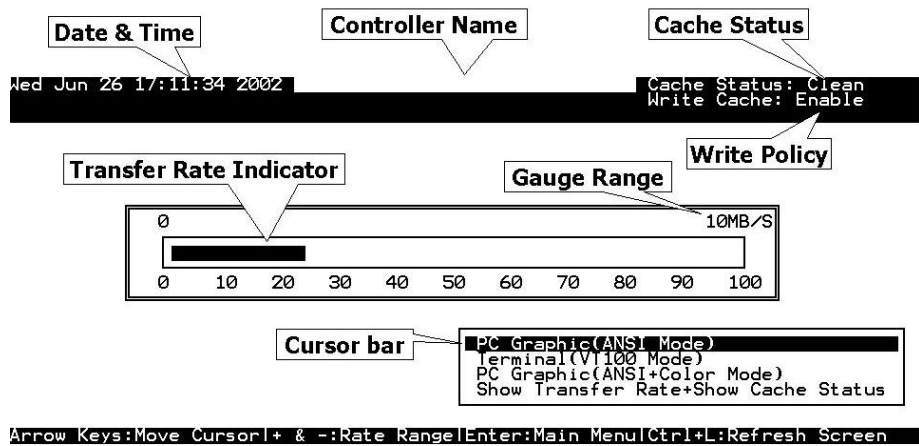

- Cursor Bar:** Move the cursor bar to a desired item, then press [ENTER] to select
- Controller Name:** Identifies the type of controller/subsystem or a preset name
- Transfer Rate Indicator:** Indicates the current data transfer rate
- Gauge Range:** Use + or - keys to change the gauge range in order to view the transfer rate indicator
- Cache Status:** Indicates current cache status
- Write Policy:** Indicates current write-caching policy
- Date & Time:** Current system date and time, generated by controller real-time clock
- PC Graphic (ANSI Mode):** Enters the Main Menu and operates in ANSI mode
- Terminal (VT-100 Mode):** Enters the Main Menu and operates in VT-100 mode
- PC Graphic (ANSI+Color Mode):** Enters the Main Menu and operates in ANSI color mode
- Show Transfer Rate+Show Cache Status:** Press [ENTER] on this item to show the cache status and transfer rate

6.2 Main Menu

```
i0:47% i1:0%                               Cache Status: Clean
                                             Write Cache: Enable
                                             BAT:BAD
< Main Menu >
Quick installation
view and edit Logical drives
view and edit logical Volumes
view and edit Host luns
view and edit scsi Drives
view and edit Scsi channels
view and edit Configuration parameters
view and edit Peripheral devices
system Functions
view system Information
view and edit Event logs

Arrow Keys:Move Cursor |Enter:Select |Esc:Exit |Ctrl+L:Refresh Screen
```

Use the arrow keys to move the cursor bar through the menu items, then press [ENTER] to choose a menu, or [ESC] to return to the previous menu/screen.

In a subsystem or controller head where battery status can be detected, battery status will be displayed at the top center. Status will be stated as Good, Bad, or several "+" (plus) signs will be used to indicate battery charge. A battery fully-charged will be indicated by five plus signs.

When initializing or scanning an array, the controller displays progress percentage on the upper left corner of the configuration screen. An "i" indicates array initialization. An "s" stands for scanning process. The number(s) next to them indicate the logical drive number (e.g., logical drive 0).

6.3 Quick Installation

```
< Main Menu >
Quick installation
v
v Create Logical Drive ? s es
v
v Yes No
v
view and edit Configuration parameters
view and edit Peripheral devices
system Functions
view system Information
view and edit Event logs
```

Type Q or use the ↑ ↓ keys to select "Quick installation", then press [ENTER]. Choose Yes to create a logical drive.

All possible RAID levels will be displayed. Use the ↑ ↓ keys to select a RAID level, then press [ENTER]. The assigned spare drive will be a Local Spare Drive, not a Global Spare Drive.

The controller will start initialization and automatically map the logical drive to LUN 0 of the first host channel.

6.4 Logical Drive Status

Cache Status: Clean Write Cache: Enable													
LG	ID	LV	RAID	Size(MB)	Status 1	2	3	0	C	#LN	#SB	#FL	NAME
P0	62EC675B	NA	RAID5	5488	GOOD			6		3	0	0	
1			NONE										
2			NONE										
3			NONE										
4			NONE										
5			NONE										
6			NONE										
7			NONE										

Arrow Keys: Move Cursor | Enter: Select | Esc: Exit | Ctrl+L: Refresh Screen

- LG** Logical Drive number
- P0:** Logical Drive 0 managed by the Primary Controller
- S0:** Logical Drive 0 managed by the Secondary Controller
- LV** The Logical volume to which this logical drive belongs
- ID** Controller-generated unique ID
- RAID** RAID level
- SIZE (MB)** Capacity of the Logical Drive
- Status 1** Logical Drive Status – Column 1
- GOOD** The logical drive is in good condition
 - DRV FAILED** A drive member failed in the logical drive
 - CREATING** Logical drive is being initiated
 - DRV ABSENT** One of its member drives cannot be detected
 - INCOMPLETE** Two or more drives failed in the logical drive
 - INVALID** The logical drive was created but has not been fully initialized when another version of firmware is being loaded. After the subsystem resets, the array status should return to normal.
 - FATAL FAIL** Two member drives failed at the same time, the array is inaccessible
 - DRV MISS** A member drive is missing
 - REBUILDING** The logical drive is being rebuilt
- Status 2** Logical Drive Status – Column 2
- I** Initializing drives
 - A** Adding drive(s)
 - E** Expanding logical drive
 - H** Add drive operation on hold
- Status 3** Logical Drive Status – Column 3
- R** Rebuilding the logical drive
 - P** Regenerating array parity

Column O	Logical Drive Status - Stripe size			
N/A	Default			
2	4KB	6	64KB	
3	8KB	7	128KB	
4	16KB	8	256KB	
5	32KB			
Column C	Logical Drive Status - Write Policy setting			
B	Write-back			
T	Write-through			
#LN	Total drive members in the logical drive			
#SB	Standby drives available for the logical drive. This includes all the spare drives (local spare, global spare) available for the specific logical drive			
#FL	Number of Failed member(s) in the logical drive			
Name	Logical drive name (user configurable)			

6.5 Logical Volume Status

Q	LV	ID	Size(MB)	#LD
v	P0	466C5C8D	60000	1
v	1			
v	2			
v	3			
v	4			
v	5			
v	6			
v	7			

Cache Status: Clean

Arrow Keys: Move Cursor | Enter: Select | Esc: Exit | Ctrl+L: Refresh Screen

LV	Logical Volume number. P0: Logical Volume 0 managed by the Primary Controller S0: Logical Volume 0 managed by the Secondary Controller
ID	Logical Volume ID number (controller randomly generated)
Size(MB)	Capacity of the Logical Volume
#LD	The number of Logical Drive(s) included in this Logical Volume

6.6 SCSI Drive Status

```

Sun Jan 6 03:03:40 2002 Cache Status: Clean

```

< Main Menu >

quick installation
 view and edit logical drives
 view and edit logical volumes
 view and edit host luns
view and edit scsi Drives

Slot	Chl	ID	Size(MB)	Speed	LG_DRU	Status	Vendor and Product ID
S	2<3>	18	17560	200MB	0	ON-LINE	SEAGATE ST318304FC
	2<3>	19	17560	200MB	0	ON-LINE	SEAGATE ST318304FC

↑ Arrow Keys: Move Cursor ↓ Enter: Select ← Esc: Exit ← Ctrl+L: Refresh Screen

Slot	Slot number of the drive; "S" indicates this is the drive used for passing through SES signals
Chl	The drive channel where the drive is connected "X<Y>" indicates two channels are configured in a dual-loop
ID	The channel ID assigned to this drive
Size (MB)	Drive capacity
Speed	XXMB Maximum transfer rate of the drive channel interface Async The drive is using asynchronous mode.
LG_DRV	X The drive is a drive member of logical drive "X." If the Status column shows "STAND-BY", the drive is a Local Spare of logical drive x.
Status	Globa The SCSI drive is a Global Spare Drive l
	INITING Processing array initialization
	ON-LINE The drive is in good condition
	REBUILD Processing Rebuild
	STAND-BY Local Spare Drive or Global Spare Drive. The Local Spare Drive's LG_DRV column will show the logical drive number. The Global Spare Drive's LG_DRV column will show "Global".
	NEW DRV A new drive has not been configured to any logical drive or as a spare drive
	USED DRV An used drive that is not a member of any logical drive or configured as spare
	FRMT DRV Formatted drive (drive formatted with a reserved section)
	BAD Failed drive
	ABSENT Drive does not exist
	MISSING Drive once existed, but is missing now

SB-MISS	Spare drive missing
Vendor and Product ID	The vendor and product model information of the drive

6.7 SCSI Channel's Status

Cache Status: Clean										
Q	Chl	Mode	PID	SID	DefSynClk	DefWid	S	Term	CurSynClk	CurWid
U	0	RCCom								
U	1	Host	*	NA	20.0MHz	Wide	S	On	Async	Narrow
U	2	Drive	7	NA	20.0MHz	Wide	S	On	Async	Wide
U	3	Drive	7	NA	20.0MHz	Wide	S	On	Async	Narrow
U	4	Drive	7	NA	20.0MHz	Wide	S	On	Async	Narrow
U	5	Drive	7	NA	20.0MHz	Wide	S	On	Async	Narrow
U	6	Drive	119	NA	1 GHz	Serial	F	NA		
U	7	Drive	119	NA	1 GHz	Serial	F	NA		

Arrow Keys: Move Cursor | Enter: Select | Esc: Exit | Ctrl+L: Refresh Screen

- Chl** SCSI channel number
- Mode** Channel mode
- RCCom Redundant controller communication channel
- Host Host Channel mode
- Drive Drive Channel mode
- PID** IDs managed by the Primary Controller
- * Multiple IDs were applied (Host Channel mode only)
- (ID number) Host Channel:
Specific IDs managed by the Primary Controller for host LUN mapping
- Drive Channel:
Specific ID reserved for the channel processor on the Primary Controller
- SID** IDs managed by the Secondary Controller
- * Multiple IDs were applied (Host Channel mode only)
- (ID number) Host Channel:
Specific IDs managed by the Secondary Controller for host LUN mapping
- Drive Channel:
Specific ID reserved for the channel processor on the Secondary controller; used in redundant controller mode
- NA No SCSI ID applied
- DefSynClk** Default SCSI bus synchronous clock:
- ???.?M The default setting of the channel is ??? MHz in Synchronous mode.
- Async. The default setting of the channel is Asynchronous mode.
- DefWid** Default SCSI Bus Width:
- Wide 16-bit SCSI
- Narrow 8-bit SCSI
- S** Signal:
- S Single-ended
- L LVD
- F Fibre

Term	Terminator Status:
	On Terminator is enabled.
	Off Terminator is disabled.
	Diff The channel is a Differential channel. The terminator can only be installed/removed physically.
CurSynClk	Current SCSI bus synchronous clock:
	???.?M The default setting of the SCSI channel is ??? MHz in Synchronous mode.
	Async. The default setting of the SCSI channel is Asynchronous mode.
	(empty) The default SCSI bus synchronous clock has changed. Reset the controller for the changes to take effect.
CurWid	Current SCSI Bus Width:
	Wide 16-bit SCSI
	Narrow 8-bit SCSI
	(empty) The default SCSI bus width has changed. Reset the controller for the changes to take effect.

6.8 Controller Voltage and Temperature

Controller Voltage and Temperature Monitoring

```
Cache Status: Clean
e Cache: Enable

< Main Menu >
Quick installation
view and edit Logical drives
view and edit logical Volumes
view and edit Host luns
view and edit scsi Drives
view and edit Scsi channels
view and edit Configuration parameters
view and edit Peripheral devices
View Peripheral Device Status
Set Peripheral Device Entry
Define Peripheral Device Active Signal
Adjust LCD Contrast
Controller Peripheral Device Configuration
View Peripheral Device Status
Voltage and Temperature Parameters

Arrow Keys:Move Cursor |Enter:Select |Esc:Exit |Ctrl+L:Refresh Screen
```

Choose from Main Menu “View and Edit Peripheral Devices,” and press [ENTER]. From the submenu, choose “Controller Peripheral Device Configuration,” “View Peripheral Device Status”, then press [ENTER].

```
Cache Status: Clean
e Cache: Enable

< Main Menu >
Quick installation
view and edit Logical drives
view and edit logical Volumes
view and edit Host luns
view and edit scsi Drives
view and edit Scsi channels
view and edit Configuration parameters
view and edit Peripheral devices
View Peripheral Device Status
Set Peripheral Device Entry
Define Peripheral Device Active Signal
Adjust LCD Contrast
Controller Peripheral Device Configuration
View Peripheral Device Status
Voltage and Temperature Parameters

ITEM VALUE STATUS
+3.3V 3.384V Operation Normally
+5V 5.260V Operation Normally
+12V 12.868V Operation Normally
CPU Temperature 32.0 (C) Temperature within Safe Range
Board1 Temperature 45.5 (C) Temperature within Safe Range
Board2 Temperature 43.0 (C) Temperature within Safe Range

Arrow Keys:Move Cursor |Enter:Select |Esc:Exit |Ctrl+L:Refresh Screen
```

The current status of voltage and temperature detected by the controller will be displayed on-screen and will be stated as normal or out of order.

6.9 Viewing Event Logs on the Screen

When errors occur, you may want to trace the records to see what has happened to your system. The controller's event log management records all events starting from the time when the system is powered on, recording up to 1,000 events. Powering off or resetting the controller will cause an automatic deletion of all the recorded event logs. To view the events log on-screen, from the Main Menu "View and Edit Event Logs" by pressing [ENTER].

```
Cache Status: Clean
< Main Menu >
Quick installation
view and edit Logical drives
view and edit Logical Volumes
view and edit Host luns
view and edit scsi Drives
view and edit Scsi channels
view and edit Configuration parameters
view and edit Peripheral devices
system functions
view system information
view and edit Event logs
Arrow Keys:Move Cursor |Enter:Select |Esc:Exit |Ctrl+L:Refresh Screen
```

```
Sun Feb 17 23:08:08 2002 Cache Status: Clean
BAT:++++
Event Logs
On-Line Initialization of Logical Drive 0 Completed
<Sun Feb 17 22:48:22 2002> <P>
LG:0 Logical Drive NOTICE: Starting On-Line Initialization
<Sun Feb 17 22:47:49 2002> <P>
Creation of Logical Drive 0 Completed
<Sun Feb 17 22:47:49 2002> <P>
LG:0 Logical Drive NOTICE: Starting Creation
<Sun Feb 17 22:47:44 2002> <P>
Controller BBU Not Fully Charged !
<Sun Feb 17 22:33:24 2002> <S>
Controller Initialization Completed
<Sun Feb 17 22:33:27 2002> <S>
Controller NOTICE: NVRAM Factory Defaults Restored
<Sun Feb 17 22:32:22 2002> <S>
Controller Initialization Completed
<Sun Feb 17 22:33:22 2002> <P>
Arrow Keys:Move Cursor |Enter:Select |Esc:Exit |Ctrl+L:Refresh Screen
```

The "P" or "S" icon on the right indicates which one of the controllers (Primary or Secondary) issued an event in a dual-controller configuration.

To clear the saved event logs, scroll the cursor down to the last event and press [ENTER].

```
Clear Above 8 Event Logs ?
  Yes  NO
```

Choose **Yes** to clear the recorded event logs.

Terminal Operation

7.1 Power on RAID Enclosure

Hardware installation should be completed before powering on your RAID enclosure. Drives must be configured and the controller properly initialized before the host computer can access the storage capacity. The configuration and administration utility resides in the controller's firmware.

Open the initial terminal screen: use the arrow keys to move the cursor bar through the menu items, then press [ENTER] to choose the terminal emulation mode, and [ESC] to return to the previous menu/screen.

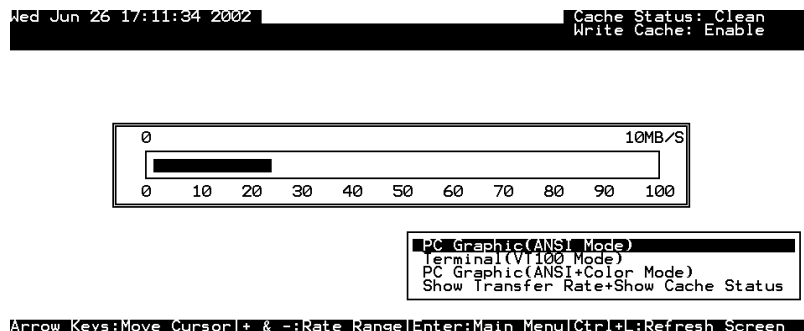

7.2 Caching Parameters

Optimization Modes

Mass storage applications can be roughly divided into two categories database and video/imaging - according to their read/write characteristics. To optimize system operation for these two categories, the controller has two embedded optimization modes with controller behaviors pre-adjusted to different read/write parameters: "Optimization for Random I/O" and the "Optimization for Sequential I/O."

Limitations:

There are limitations on the use of optimization modes.

1. You can select the stripe size of each array (logical drive) during the initial configuration. However, changing stripe size is only recommended for experienced engineers who have tested the effects of tuning stripe sizes for different applications.
2. The array stripe size can only be changed when creating a logical drive.
3. Think twice before choosing the optimization mode. Once the controller optimization mode is applied, access to different arrays in a RAID system will follow the same optimized pattern. **You can only change the optimization mode after recreating the arrays.**

Database and Transaction-based Applications:

These kinds of applications usually includes SQL server, Oracle server, Informix, or other database services. These applications keep the size of each transaction down to a minimum, so that I/Os can be rapidly processed. Due to its transaction-based nature, these applications do not read or write a bunch of data in a sequential order - access to data occurs randomly. The transaction size usually ranges from 2K to 4K. Transaction performance is measured in "I/Os per second" or "IOPS."

Video Recording/Playback and Imaging Applications:

These kinds of applications usually include video playback, video post-production editing, or applications of a similar nature. These applications have the tendency to read or write large files from and into storage in a sequential order. The size of each I/O can be 128K, 256K, 512K, or up to 1MB. The efficiency of these applications is measured in "MB/sec."

When an array works with applications such as video or image-oriented applications, the application reads/writes from the drive as large-block, sequential threads instead of small and randomly accessed files.

The controller optimization modes have read-ahead buffer and other Read/Write characteristics tuned to obtain the best performance for these two major application categories.

Optimization Mode and Stripe Size

Each controller optimization mode has preset values for the stripe size of arrays created in different RAID levels. If you want a different optimization mode for a configured array, you need a duplicate of the data in your array elsewhere, select a different optimization mode, reset the controller/subsystem, and re-create the array. Once the array is created, stripe size cannot be changed.

Using the default value should be sufficient for most applications. The interrelation among stripe sizes, optimization modes, and RAID levels is shown in the table below:

Table 7 - 1 RAID Levels, Optimization Modes, and Stripe Sizes

	Stripe Size: Opt. for Sequential I/O	Stripe Size: Opt. for Random I/O
RAID0	128	32
RAID1	128	32
RAID3	16	4
RAID5	128	32

Optimization for Random or Sequential I/O

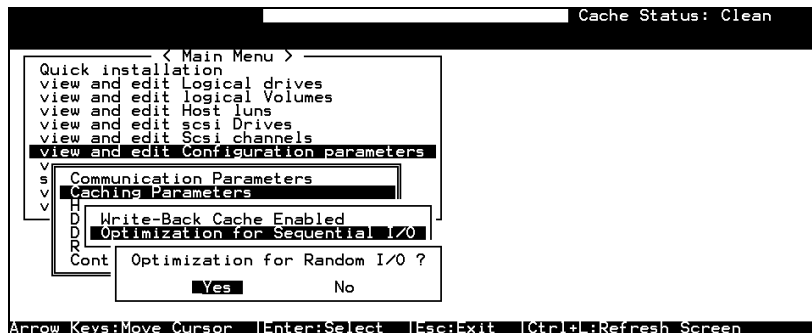

Choose "Optimization for Random I/O" or "Optimization for Sequential I/O," then press [ENTER]. The "Random" or "Sequential" dialog box will appear, depending on the option you have selected. Choose **Yes** in the dialog box that follows to confirm the setting.

Write-Back/Write-Through Cache Enable/Disable

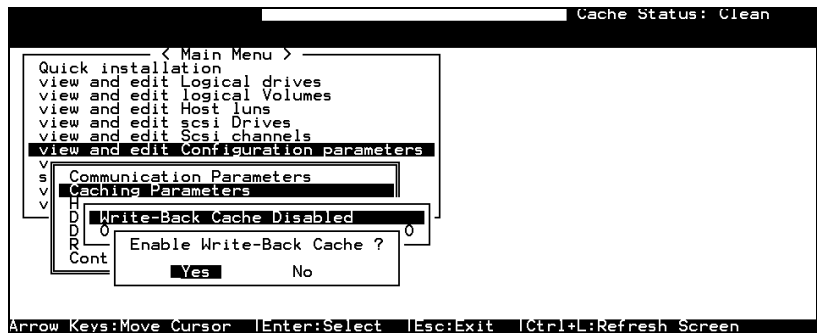

Choose “Caching Parameters”, then press [ENTER]. Select “Write-Back Cache,” then press [ENTER]. “Enabled” or “Disabled” will display the current setting with Write-Back caching. Choose **Yes** in the dialog box that follows to confirm the setting.

The Write-through mode is safer if your controller is not configured in a redundant pair and there is no battery backup or UPS device to protect cached data.

Write-back caching can dramatically improve write performance by caching the unfinished writes in memory and letting them be committed to drives in a more efficient manner. In the event of power failure, a battery module can hold cached data for days. If a controller fails in a dual-controller configuration, an exact replica of the data cached in the failed controller is preserved by its counterpart controller and therefore the data can be retrieved once the normal working condition is restored.

Periodic Cache Flush

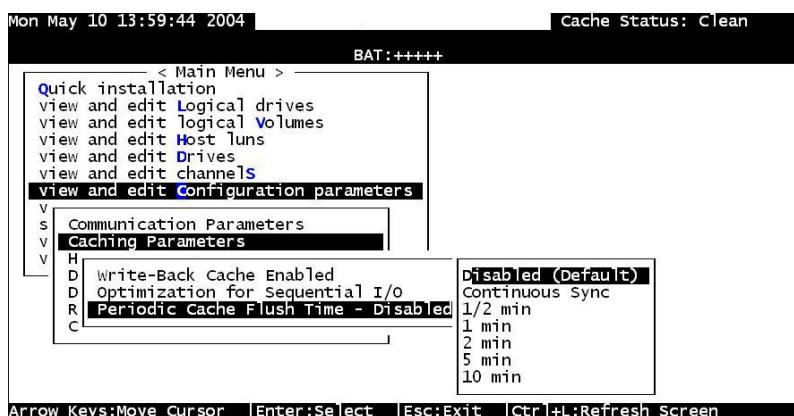

If for a reason Write-Back caching is preferred for better performance and yet data integrity is of the concern, e.g., lack of the battery protection, the system can be configured to flush the cached writes at every preset interval.

Note that the “Continuous Sync” option holds data in cache for as long as necessary to complete a write operation and immediately commits it to hard drives if it does not come in a series of sequential write requests.

Adaptive Write Policy

```
Tue Feb 19 21:35:10 2002 Cache Status: Clean
BAT:++++
< Main Menu >
Quick installation
view and edit Logical drives
view and edit logical Volumes
view and edit Host luns
view and edit Drives
view and edit channels
view and edit Configuration parameters
V
S Communication Parameters
V Caching Parameters
V
H
D write-Back Cache Enabled
D Optimization for Sequential I/O
R Periodic Cache Flush Time - Disabled (Default)
C Adaptive Write Policy - Disabled

Arrow Keys:Move Cursor | Enter:Select | Esc:Exit | Ctrl+L:Refresh Screen
```

Firmware is embedded with intelligent algorithms to detect and to adapt the array’s caching mode to the characteristics of I/O requests. The capability is described as follows:

1. When enabled, the adaptive write policy optimizes array performance for sequential writes.
2. The adaptive policy temporarily disables an array’s write-caching algorithm when handling sequential writes. Write-caching can be unnecessary with sequential writes for that write requests can be more efficiently fulfilled by conducting writes onto disk drives following the receiving order.
3. The adaptive policy changes the preset write policy of an array when handling I/Os with heterogeneous characteristics. If firmware determines it is receiving write requests that come in a sequential order, the write-caching algorithm is disabled on the target logical drives.

If the subsequent I/Os are fragmented and are received randomly, firmware automatically restores the original write-cache policy of the target logical drives.

Adaptation for the Redundant Controller Operation

4. If arrays managed by a redundant-controller configuration are configured to operate with write-back caching, cached data will be constantly synchronized between the partner controllers. Upon receiving sequential writes, firmware disables write-caching on target arrays and also the synchronized cache operation.

IMPORTANT!

- *If the size of an array is larger than 16TB, only the optimization for sequential I/O can be applied. A logical drive of this size is not practical; therefore, there is actually no limitation on the combination of optimization mode and array capacity.*
 - *Every time you change the Caching Parameters, you must reset the controller for the changes to take effect.*
 - *In the redundant controller configuration, write-back will only be applicable when there is a synchronized cache channel strung between partner controllers.*
 - *The Adaptive Write Policy is applicable to subsystems working in the normal condition. If, for example, a drive fails in an array, firmware automatically restores the array's original write policy.*
-

7.3 Viewing the Connected Drives

Prior to configuring disk drives into a logical drive, it is necessary to understand the status of the physical drives in your enclosure.

Cache Status: Clean								
	Slot	Chl	ID	Size(MB)	Speed	LG_DRV	Status	Vendor and Product ID
Quick view	2	0		2010	20MB	NONE	NEW DRV	
view	2	1		2010	20MB	NONE	NEW DRV	
view	2	2		2010	20MB	NONE	NEW DRV	
view	2	3		2010	20MB	NONE	NEW DRV	
view	2	4		2010	20MB	NONE	NEW DRV	
view	2	5		2010	20MB	NONE	NEW DRV	
view	2	6		2010	20MB	NONE	NEW DRV	
view	2	8		2010	20MB	NONE	NEW DRV	

Arrow Keys:Move Cursor |Enter:Select |Esc:Exit |Ctrl+L:Refresh Screen

Use the arrow keys to scroll down to “View and Edit SCSI Drives.” This will display information on all the physical drives installed.

Drives will be listed in the table of “View and Edit SCSI Drives.” Use the arrow keys to scroll the table. You may first examine whether there is any drive installed but not listed here. If a drive is installed but not listed, the drive may be defective or not installed correctly. Please contact your RAID supplier.

IMPORTANT!

- Drives of the same brand/model/capacity might not have the same block number.
- The basic read/write unit of a hard drive is block. If members of a logical drive have different block numbers (capacity), the smallest block number will be taken as the maximum capacity to be used in every drive. Therefore, use drives of the same capacity.
- You may assign a Spare Drive to a logical drive whose members have a block number equal or smaller than the Local/Global Spare Drive, but you should not do the reverse.

7.4 Creating a Logical Drive

Browse through the Main Menu and select “View and Edit Logical Drive.”

LG	ID	LV	RAID	Size(MB)	Status	1	2	3	0	C	#LN	#SB	#FL	NAME
0			NONE											
1			NONE											
2			NONE											
3			NONE											
4			NONE											
5			NONE											
6			NONE											
7			NONE											

Cache Status: Clean
Write Cache: Enable

Arrow Keys: Move Cursor | Enter: Select | Esc: Exit | Ctrl+L: Refresh Screen

For the first logical drive on the RAID, simply choose LG 0 and press [ENTER] to proceed. You may create as many as 128 logical drives from drives on any drive channel or within a cascaded enclosure.

When prompted to “Create Logical Drive?,” select **Yes** and press [ENTER] to proceed.

Create Logical Drive ?
<input checked="" type="radio"/> Yes <input type="radio"/> No

Choosing a RAID Level:

A pull-down list of supported RAID levels will appear. In this chapter, RAID 5 will be used to demonstrate the configuration process. Choose a RAID level for this logical drive.

RAID 5
RAID 3
RAID 1
RAID 0
NRAID

Choosing Member Drives:

Choose your member drive(s) from the list of available physical drives. The drives can be tagged for inclusion by positioning the cursor bar on the drive and then pressing [ENTER]. An asterisk (*) mark will appear on the selected physical drive(s). To deselect the drive, press [ENTER] again on the selected drive. The "*" mark will disappear. Use the same method to select more drives.

LG	Slot	Chl	ID	Size(MB)	Speed	LG_DRV	Status	Vendor and Product ID
0	*	1	0	9999	80MB	NONE	NEW DRV	
1	*	1	1	9999	80MB	NONE	NEW DRV	
2	*	1	2	9999	80MB	NONE	NEW DRV	
3		1	3	9999	80MB	NONE	NEW DRV	
4		1	4	9999	80MB	NONE	NEW DRV	
5		1	5	9999	80MB	NONE	NEW DRV	
6		1	6	9999	80MB	NONE	NEW DRV	
7		1	8	9999	80MB	NONE	NEW DRV	

Cache Status: Clean
Write Cache: Enable
3 of 8 Selected

Arrow Keys: Move Cursor | Enter: Select | Esc: Confirm | Ctrl+L: Refresh Screen

Logical Drive Preferences

Maximum Drive Capacity :	9999MB
Assign Spare Drives	
Disk Reserved Space:	256 MB
Logical Drive Assignments	
Write Policy:	Default(Write-Back)
Initialize Mode:	On-Line
Stripe Size:	Default

After all member drives have been selected, press [ESC] to continue with the next option. A list of array options is displayed.

Maximum Drive Capacity:

Maximum Available Drive Capacity(MB):	9999
Maximum Drive Capacity(MB)	: 9999

As a rule, a logical drive should be composed of drives of the same capacity. A logical drive can only use the capacity of each drive up to the maximum capacity of the smallest drive selected for the array.

Assign Spare Drives

Slot	Chl	ID	Size(MB)	Speed	LG_DRV	Status	Vendor and Product ID
1	4	9999	40MB	NONE	NONE	NEW DRV	
	1	5	9999	40MB	NONE	NEW DRV	
	1	6	9999	40MB	NONE	NEW DRV	
	1	8	9999	40MB	NONE	NEW DRV	

You can add a spare drive from the list of the unused drives. The spare chosen here is a Local spare and will automatically replace any failed drive in the event of drive failure. The controller will then rebuild data onto the replacement drive.

A logical drive composed in a non-redundancy RAID level (NRAID or RAID 0) does not support spare drive rebuild.

Disk Reserved Space

```
Maximum Drive Capacity : 244MB
Assign Spare Drives
Disk Reserved Space: 256 MB
W 256MB
I Backward Compatible(64KB)
S ck)
```

The reserved space is a small section of disk space formatted for storing array configuration and RAIDWatch program data. Do not change the size of reserved space unless you want your array to be accessed by controllers using older firmware.

Logical Drive Assignments:

```
Maximum Drive Capacity : 9999MB
Assign Spare Drives
Disk Reserved Space: 256 MB
W Logical Drive Assignments
S Redundant Controller Logical Drive Assign to Secondary Controller ?
   Yes No
```

If you use two controllers for a dual-active configuration, a logical drive can be assigned to either of the controllers to balance workload. The default is the Primary Controller; press [ESC] if change is not preferred. Logical drive assignment can be changed at any time.

Write Policy

```
Maximum Drive Capacity : 9999MB
Assign Spare Drives
Disk Reserved Space: 256 MB
W Logical Drive Assignments
S Write Policy: Default(Write-Back)
   Change Write Policy ?
   Default Write-Back Write-Through
```

This sub-menu allows you to set the caching mode for this specific logical drive. "Default" is a neutral value that is coordinated with the controller's current caching mode setting, that you can see bracketed in the Write Policy status.

Initialization Mode

```
Maximum Drive Capacity : 9999MB
Assign Spare Drives
Disk Reserved Space: 256 MB
W Logical Drive Assignments
S Write Policy: Default(Write-Back)
   Initialize Mode: On-Line
   Off-line Initialize for Create Logical Drive ?
   Yes No
```

This sub-menu allows you to see if the logical drive is immediately available. If the online (default) mode is used, data can be written onto it and you may continue with array configuration, e.g., including the array into a logical volume, before the array's initialization is completed.

Stripe Size



This option should only be changed by experienced engineers. Setting to an incongruous value can severely drag performance. This option should only be changed when you can be sure of the performance gains it might bring you.

The default value is determined by the combination of the controller **Optimization Mode** setting and the **RAID level** used for the array.

Press [ESC] to continue when all the preferences have been set.

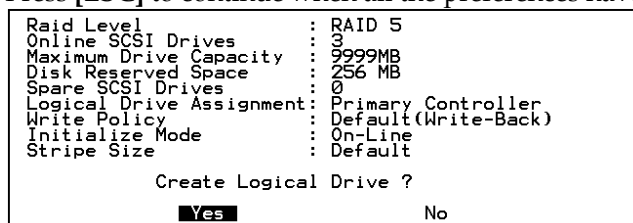

A confirm box will appear on the screen. Verify all information in the box before choosing "Yes" to confirm and proceed.



If the online initialization mode is applied, the logical drive will first be created and the controller will find an appropriate time to initialize the array.

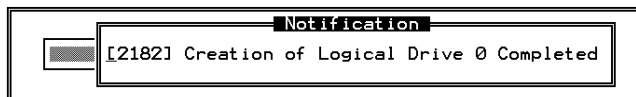

The completion of array creation will be indicated by the message prompt above.



A controller event will then prompt to indicate that the logical drive initialization has begun. Tap [ESC] to cancel the "Notification" prompt, and a progress indicator will display on the screen as a percentage bar.

The array initialization runs in the background while you can start using the array or continue configuring your RAID system.

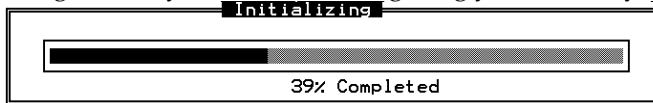

When a fault-tolerant RAID level (RAID 1, 3, or 5) is selected, the controller will start initializing parity.

Use the [ESC] key to view the status of the created logical drive.

Cache Status: Clean
Write Cache: Enable

LG	ID	LV	RAID	Size(MB)	Status	1	2	3	0	C	#LN	#SB	#FL	NAME
P0	6A3021B	NA	RAID5	19998	GOOD					S	3	0	0	

View scsi drives
Delete logical drive
Partition logical drive
logical drive Name
logical drive Assignments
Expand logical drive
add Scsi drives
reGenerate parity
copy and replace drive
Media scan
Write policy

7			NONE											
---	--	--	------	--	--	--	--	--	--	--	--	--	--	--

Arrow Keys: Move Cursor | Enter: Select | Esc: Exit | Ctrl+L: Refresh Screen

IMPORTANT!

- Note that only logical drives with RAID levels 1, 3, or 5 will take the time to initialize the logical drive. Logical drives with RAID level 0 and RAID do not perform logical drive initialization; the drive initialization will be finished almost immediately.

7.5 Creating a Logical Volume

Cache Status: Clean

Q	LV	ID	Size(MB)	#LD
v	0			
v	1			
v	2			
v	3			
v	4			
v	5			
v	6			
v	7			

parameters
vices

Arrow Keys: Move Cursor | Enter: Select | Esc: Exit | Ctrl+L: Refresh Screen

LV	ID	Size(MB)	#LD
0			
1	Create Logical Volume ?		
2	<input checked="" type="radio"/> Yes	<input type="radio"/> No	
3			
4			
5			
6			
7			

A logical volume consists of one or several logical drives. Choose "View and Edit Logical Volumes" in the Main Menu. The current logical volume configuration and status will be displayed on the screen. Choose a logical volume number (0-7) that has

not yet been defined, then press [ENTER] to proceed. A prompt "Create Logical Volume?" will appear. Select "Yes" and press [ENTER].

Cache Status: Clean
Write Cache: Enable
2 of 3 Selected

Q	LV	ID	Size(MB)	#LD	
v	0				

LG	ID	LV	RAID	Size(MB)	Status	1	2	3	0	C	#LN	#SB	#FL	NAME
*P0	477F9A88	NA	RAID5	39996	GOOD					S	3	0	0	
*P1	3D54C97	NA	RAID0	19998	GOOD					S	2	-	0	
P2	40447683	NA	RAID0	19998	GOOD					S	2	-	0	

5			
6			
7			

Arrow Keys: Move Cursor | Enter: Select | Esc: Exit | Ctrl+L: Refresh Screen

Select one or more logical drive(s) available on the list. The same as creating a logical drive, the logical drive(s) can be tagged for inclusion by positioning the cursor bar on the desired drive and then press [ENTER] to select. An asterisk (*) mark will appear on the selected drive. Press [ENTER] again will deselect a logical drive.

Q	LV	ID	Size(MB)	#LD	
v	0				
v	1				
v	2				
v	3				
s	4				
v	5				
v	6				
v	7				

Initialization Mode - On-Line
Write Policy - Default
Logical Volume Assignment - Primary

Use arrow keys to select a sub-menu and make change to the initialization mode, write policy, or the managing controller. Logical volumes can be assigned to different controllers (primary or secondary). Default is primary.

Logical Drive Count : 2
 Logical Volume Assignment : Primary Controller
 Write Policy : Write-Through
 Initial Mode : On-Line

Create Logical Volume ?

Yes No

Note that if a logical volume is manually assigned to a specific controller, all its members' assignment will also be shifted to that controller.

As all the member logical drives are selected, press [ESC] to continue. The confirm box displays. Choose Yes to create the logical volume.

Q	LV	ID	Size(MB)	#LD	
v	P0	2099036B	59956	2	
v	1	View logical drive			ters
v	2	Delete logical volume			
v	3	Partition logical volume			
s	4	Logical volume Assignments			
v		Expand logical volume			
v		Write Policy			
v		add Logical drive			
	5				
	6				
	7				

Press [ENTER] and the information of the created logical volume displays.

- LV: Logical Volume ID
- P0: Logical Volume 0 managed by the primary controller
- S0: Logical Volume 0 managed by the secondary controller
- ID: Unique ID for the logical volume, randomly generated by the controller
- Size: Capacity of this volume
- #LD: Number of the included members

7.6 Partitioning a Logical Drive/Logical Volume

The process of partitioning a logical drive is the same as that of partitioning a logical volume. The partitioning of a logical volume is used as an example in the proceeding discussion.

Please note that partitioning can be very useful when dealing with a very large capacity; however, partitioning a logical drive or logical volume is not a requirement for RAID configuration.

Cache Status: Clean
Write Cache: Enable

Q	LV	ID	Size(MB)	#LD	
v	P0	2099036B	59956	2	
v	1	View logical drive			ters
v	2	Delete logical volume			
v	3	Partition logical volume			
s	4	Logical volume Assignments			
v		Expand logical volume			
v		Write Policy			
v		add Logical drive			
	5				
	6				
	7				

Arrow Keys: Move Cursor | Enter: Select | Esc: Exit | Ctrl+L: Refresh Screen

Choose the logical volume you wish to partition, then press [ENTER]. Choose "Partition logical volume", then press [ENTER]. Select from the list of undefined partitions and press [ENTER].

A list of partitions displays. If the logical volume has not yet been partitioned, all volume capacity will list as "partition 0."

Q	LV	ID	Size(MB)	#LD	Partition	Offset(MB)	Size(MB)
v	P0	2099C36B	59956	2	0	0	59956
v	1						
v	2						
v	3						
v	4						
v	5						
v	6						
v	7						

Partition	Offset(MB)	Size(MB)
0	0	59956
3		
4		
5		
6		
7		

Parameter Size (MB): 59956 _

Press [ENTER] and type the desired size for the selected partition, and then press [ENTER] to proceed. The remaining size will be automatically allotted to the next partition.

Choose **Yes** to confirm when prompted to the "Partition Logical Volume?" message. Press [ENTER] to confirm. Follow the same procedure to partition the remaining capacity of your logical volume.

Q	LV	ID	Size(MB)	#LD	Partition	Offset(MB)	Size(MB)
v	P0	2099C36B	59956	2	0	0	59956
v	1						
v	2						
v	3						
v	4						
v	5						
v	6						
v	7						

Partition	Offset(MB)	Size(MB)
0	0	59956
5		
6		
7		

This operation will result in the LOSS OF ALL DATA on the Partition !
Partition Logical Volume ?
Yes No

When a partition of a logical drive/logical volume is deleted, the capacity of the deleted partition will be added to the last partition.

WARNING!

- Whenever a partition is changed, it is necessary to re-configure all host LUN mappings. All data in it will be lost and all the host LUN mappings will be removed with any change to partition capacity.
 - If operated with a Unix-based system, reset the subsystem for the configuration changes to take effect if any changes have been made to partition sizes and partition arrangement.
-

7.7 Mapping a Logical Volume to Host LUNs

Select "View and Edit Host luns" in the Main Menu, then press [ENTER].

```

      < Main Menu >
Quick installation
view and edit Logical drives
view and edit logical Volumes
view and edit Host luns
v
v CHL 0 ID 0 (Primary Controller)
v CHL 0 ID 1 (Secondary Controller)
v CHL 1 ID 0 (Primary Controller)
s CHL 1 ID 1 (Secondary Controller)
v Edit Host-ID/WWN Name List
v
```

A list of host channel/ID combinations appears on the screen. The diagram above shows two host channels and each is designated with both a primary and a secondary ID.

Multiple IDs on host channels are necessary for redundant controller configuration. Details on creating multiple IDs and changing channel modes will be discussed later. Choose a host ID by pressing [ENTER].

Several details are noticeable here:

1. A logical group of drives (logical drive/logical volume) previously assigned to the primary controller cannot be mapped to a secondary ID. Neither can those assigned to the secondary controller be mapped to a primary ID.
2. For a SCSI-based controller, ID 7 is reserved for the controller itself. If there are two controllers, controllers might occupy ID6 and ID7, or ID8 and ID9. Please check your system Hardware Manual for details on reserved IDs.

```

      < Main Menu >
Quick installation
view and edit Logical drives
view and edit logical Volumes
view and edit Host luns
v
v CHL 0 ID 0 (Primary Controller)
v C ry Controller)
v C Logical Drive Controller)
v C Logical Volume ry Controller)
s E me List
v
```

Choose the "channel-ID" combination you wish to map, then press [ENTER] to proceed. Choose mapping a "Logical Drive" or a "Logical Volume" on the drop box.

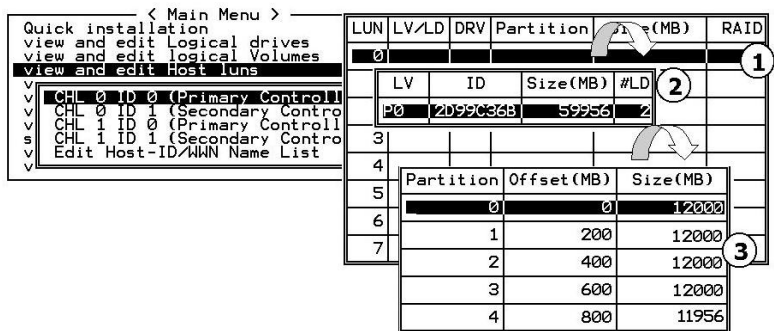

1. A list of LUN entries and their respective mappings will be displayed. To map a host LUN to a logical volume's partition, select an available LUN entry (one not mapped yet) by moving the cursor bar to the LUN, then press [ENTER].
2. A list of available logical volumes displays. Move the cursor bar to the desired logical unit, then press [ENTER].
3. A list of available partitions will prompt. Move the cursor bar to the desired partition, then press [ENTER]. If you have not partitioned the logical volume, the whole capacity will be displayed as one logical partition.
4. When prompted to "Map Host LUN," press [ENTER] to proceed. To access control over a Fibre network, see in *Chapter 8* for details on how to "Create Host Filter Entry."



5. When prompted to "Map Logical Volume?," select **Yes** to continue.

A prompt will display the mapping you wish to create. Choose **Yes** to confirm the LUN mapping you selected.

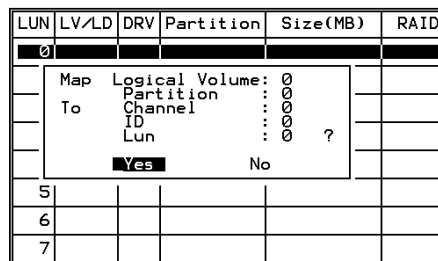

The detail in the confirm box reads: partition 0 of logical volume 0 will map to LUN 0 of SCSI ID 0 on host channel 0.

Continue to map other partitions to host LUNs.

With any of the Host ID/LUN successfully associated with a logical capacity, the "No Host LUN" message in the LCD screen will change to "Ready."

If your controller has not been configured with a host channel and assigned with SCSI ID, please move on to Section 7.12 *Viewing and Editing Channels.*

7.8 Assigning Spare Drive, Rebuild Settings

Adding Local Spare Drive

A spare drive is a standby drive automatically initiated by controller firmware to replace a failed drive. A spare drive must have an equal or larger capacity than the array members. A local spare should have a capacity equal to or larger than the members of the logical drive it is assigned to. A global spare should have a capacity equal to or larger than all physical drives in a RAID system.

Slot	Chl	ID	Size(MB)	Speed	LG_DRV	Status	Vendor and Product ID
2	0	9999	80MB	0	ON-LINE		
2	1	9999	80MB	0	ON-LINE		
2	3	9999	80MB	NONE	NEW DRV		

LG	ID	LV	RAID	Size(MB)	Status	1	2	3	0	C	#LN	#SB	#FL	NAME
P0	477F9A88	0	RAIDS	99999	GOOD					S	3	0	0	

1. Choose "View and Edit SCSI Drives" on the Main Menu, then press [ENTER]. Move the cursor bar to a SCSI drive that is not assigned to a logical drive or as a spare drive (usually indicated as a "New Drive"), and then press [ENTER].
2. Choose "Add Local Spare Drive" and press [ENTER]. A list of logical drives displays.
3. Move the cursor bar to a logical drive, then press [ENTER]. The unassigned SCSI drive will be associated with this logical drive as a Local Spare.
4. When prompted to "Add Local Spare Drive?", choose **Yes** to confirm.

Deleting a Logical Drive

Choose the logical drive you wish to delete, then press [ENTER]. Choose "Delete logical drive." Choose **Yes** when prompted to confirm.

Deleting a Partition of a Logical Drive

LG	ID	LV	RAID	Size(MB)	Partition	Offset(MB)	Size(MB)	NAME
P0	4149A729	NA	RAID5	39	0	0	3999	
P1	76CD4DF6	NA	RAID0	119	1	3999	3999	
2			NONE					
3			NONE					
4			NONE		4	15999	3999	
5			NONE		5			
6			NONE		6			
7			NONE		7			

Choose the logical drive which has a partition you wish to delete, then press [ENTER]. Choose "Partition logical drive." Partitions of the logical drive will be displayed in tabulated form. Move the cursor bar to the partition you wish to delete, then press [ENTER].

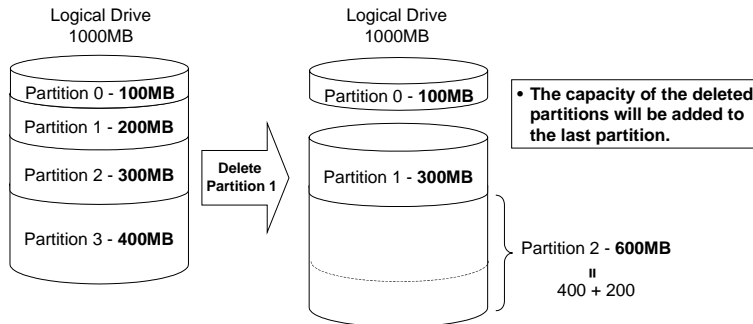

Enter "0" on the partition size to delete the partition.

Figure 7 - 1 Drive Space Allocated to the Last Partition

As illustrated above, the capacity of the deleted partition will be added to the last partition.

WARNING!

- Whenever a partition is changed, it is necessary to reconfigure all host LUN mappings. All data kept in the partition and the host LUN mappings will be removed with any partition change.

Assigning a Name to a Logical Drive

Naming can help identify different arrays in a multi-array configuration. This function is also useful in special situations. For example, when one or more logical drives have been deleted, the array indexing is changed after system reboot. The second logical drive might become the first on the list.

LG	ID	LV	RAID	Size(MB)	Status	1	2	3	0	C	#LN	#SB	#FL	NAME
P0	477-9A8B	0	RAID5	9999	GOOD					5	3	0	0	
P	View scsi drives													
P	Delete logical drive													
P	Partition logical drive													
	logical drive Name													
	Current Logical Drive Name: _____ New Logical Drive Name: _____													
7			NONE											

Choose the logical drive for which you wish to assign a name, then press [ENTER]. Choose "logical drive name," then press [ENTER] again. The current name will be displayed. You may now enter a new name in this field. Enter a name, then press [ENTER] to save the configuration.

Rebuilding a Logical Drive

If there is no spare drive in the system, a failed drive should be immediately replaced by a drive known to be good. Once the failed drive is replaced, the rebuild process can be manually initiated.

If you want the controller to auto-detect a replacement drive, make sure you have the following items set to "enabled":

1. Periodic Drive Check Time
2. Periodic Auto-Detect Failure Drive Swap Check Time

These two configuration options can be found under "View and Edit Configuration Parameters" -> "Drive-Side SCSI Parameters".

Q	LG	ID	LV	RAID	Size(MB)	Status	0	#LN	#SB	#FL	NAME
P0	4149A729	NA	RAID5	19998	DRU FAILED	R	2	0	0		
P	View scsi drives										
P	Delete logical drive										
P	Partition logical drive										
	logical drive Name										
	Rebuild logical drive										
	Rebuild Logical Drive ? <input checked="" type="checkbox"/> Yes <input type="checkbox"/> No										
5											
6			NONE								
7			NONE								

Choose the logical drive that has a failed member drive, then press [ENTER]. Choose "Rebuild logical drive", then press [ENTER]. When prompted to "Rebuild Logical Drive?," select Yes.

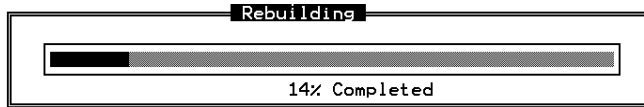

The rebuild progress will be displayed.

When rebuild has already started, choose “Rebuild progress” to see the rebuilding progress.

IMPORTANT!

- *The Rebuild function is only available when a logical drive (with RAID level 1, 3 or 5) has a failed member. NRAID and RAID 0 configurations provide no data redundancy.*
-

Regenerating Logical Drive Parity

(Applies to RAID Levels 1, 3, and 5)

If no verifying method is applied to data writes, this function can be often performed to verify parity blocks of a selected array. This function compares and recalculates parity data to correct parity errors.

LG	ID	LV	RAID	Size(MB)	Status	1	2	3	0	C	#LN	#SB	#FL	NAME	
P0	4295529B	NA	RAID5	476000	GOOD						4	8	3	0	0
Execute Regenerate Logical Drive Parity Overwrite Inconsistent Parity - Enabled Generate Check Parity Error Event - Enabled															
3			NONE												
4			NONE												
5			NONE												
6			NONE												
7			NONE												

Choose the logical drive that you want to regenerate the parity for, and then press [ENTER]. Choose “Regenerate Parity,” then press [ENTER]. When prompted to “Regenerate Parity?”, select Yes.

Please refer to *Chapter 11 Data Integrity* for more information on Parity Regeneration.

Media Scan

Media Scan is used to examine drives and is able to detect the presence of bad blocks. If any data blocks have not been properly committed and are found during the scanning process, data from those blocks are automatically recalculated, retrieved and stored onto undamaged sectors. If bad blocks are encountered on yet another drive during the rebuild process, the block LBA (Logical Block Address) of those bad blocks will be shown. If rebuild is carried out under this situation, rebuild will continue with the unaffected sectors, salvaging the majority of the stored data.

Wed Jun 26 16:37:56 2002 Cache Status: Clean
Write Cache: Enable

BAT:BAD

LG	ID	LV	RAID	Size(MB)	Status	1	2	3	0	C	#LN	#SB	#FL	NAME
P0	20F7C6CS	NA	RAID0	277976	GOOD				7		8	-	0	
P1	76620CBA0	NA	RAID5	694	GOOD				7		3	0	0	
Media Scan Priority - Normal														
Iteration Count - Single Time														
4			NONE											
5			NONE											
6			NONE											
7			NONE											

Arrow Keys:Move Cursor |Enter:Select |Esc:Exit |Ctrl+L:Refresh Screen

There are two options with performing the Media Scan:

1. **Media Scan Priority:** determines how much system resources will be used for the drive scanning and recalculating process.
2. **Iteration Count:**

Media Scan Priority - Normal
Iteration Count - Single Time

Set Media Scan Iteration Count to Continuous Scan ?

Yes No

The iteration setting determines how many times the scan is performed. If set to “continuous,” the scan will run in the background continuously until it is stopped by user.

System can automatically perform a media scan according to a preset task schedule. For more details, please refer to **Chapter 11 Data Integrity**.

Write Policy

View scsi drives
Delete logical drive
Partition logical drive
logical drive Name
logical drive Assignments
Expand logical drive
add Scsi drives
copy and replace drive
Write policy

Change Write Policy ?

Default Write-Back Write-Through

The Write-Back cache setting is configurable on the per array basis. Setting to the default value means the array setting is coordinated with the controller’s general setting. The controller’s general setting

option can be found in "View and Edit Configuration Parameters" -> "Caching Parameters" -> "Write-Back Cache". Note that cached writes are lost if a power failure occurs.

7.10 Viewing and Editing Host LUNs

Viewing or Deleting LUN Mappings

Choose the host channel and host ID combination you wish to view or delete.

Cache Status: Clean
Write Cache: Enable

```

< Main Menu >
Quick installation
view and edit Logical drives
view and edit logical Volumes
view and edit Host Luns
v CHL 0 ID 0 (Primary Controller)
v CHL 0 ID 1 (Secondary Controller)
v CHL 1 ID 0 (Primary Controller)
s CHL 1 ID 1 (Secondary Controller)
v Edit Host-ID/WWN Name List
  
```

LUN	LV/LD	DRV	Partition	Size(MB)	RAID
0	LD	2	0	9999	RAID5
3					
4					
5					
6					
7					

Unmap Host Lun ?
 Yes No

Arrow Keys: Move Cursor | Enter: Select | Esc: Exit | Ctrl+L: Refresh Screen

A list of the current LUN mapping will be displayed on the screen. Move the cursor bar to the LUN mapping you wish to delete, then press [ENTER]. Select **Yes** to delete the LUN mapping, or **No** to cancel.

Edit Host-ID/WWN Name List

This is a specific item used for systems communicating over Fibre host loops. Please refer to *Chapter 8 Fibre Operation* for more details.

Pass-through SCSI Commands

```

< Main Menu >
Quick installation
view and edit Logical drives
view and edit Host Luns
v Host Channel
v CHL 0 ID 0 (Primary Controller)
v CHL 0 ID 1 (Secondary Controller)
v CHL 1 ID 0 (Primary Controller)
s CHL 1 ID 1 (Secondary Controller)
v Edit Host-ID/WWN Name List
  
```

Slot	Chl	ID	Size(MB)	Speed	LG_DRU	Status	Vendor and Product ID
	2	0	1010	40MB	0	ON-LINE	SEAGATE ST31055W

Map Physical Drive Chl: 2
Physical Drive ID : 0
Host Channel : 0
Host ID : 0 ?
 Yes No

If you have primary and secondary controllers, move the cursor to the controller for the device that you wish to map, then press

[ENTER]. You will be prompted to map a SCSI ID to a physical drive.

WARNING!

- *Pass-through SCSI Commands are only intended to perform maintenance functions for a drive or device on the drive side. **Do not** perform any destructive commands to a disk drive (i.e., any commands that write data to a drive media). This will result in inconsistent parity among drives included in a logical configuration of drives. If a disk drive is a spare drive or a member of a logical drive, such a destructive command may cause a data inconsistency.*
 - *When a drive/device is mapped to a host SCSI ID so that Pass-through SCSI Commands can be used, the data on that drive/device will not be protected by the controller. Users who employ Pass-through SCSI Commands to perform any write commands to drive media do so at their own risk.*
-

7.11 Viewing and Editing Drives

view	Slot	Chl	ID	Size(MB)	Speed	LG_DRV	Status	Vendor and Product ID
view	2	0	9999	40MB	0	ON-LINE	SEAGATE ST31055W	
view	2	1	9999	40MB	0	ON-LINE	SEAGATE ST31055W	
view	2	3	9999	40MB	0	ON-LINE	SEAGATE ST31055W	
view	2	4	9999	40MB	1	ON-LINE	SEAGATE ST31055W	
view	2	5	9999	40MB	1	ON-LINE	SEAGATE ST31055W	
view	2	6	9999	40MB	1	ON-LINE	SEAGATE ST31055W	
view	2	8	9999	40MB	NONE	NEW DRV	SEAGATE ST31055W	

Arrow Keys:Move Cursor |Enter:Select |Esc:Exit |Ctrl+L:Refresh Screen

Choose “View and Edit Drives” in the Main Menu. All drives attached to the drive channels will be displayed on the screen.

Scanning New Drive

Cache Status: Clean
Write Cache: Enable

Slot	Chl	ID	Size(MB)	Speed	LG_DRV	Status	Vendor and Product ID
2	0	9999	40MB	0	ON-LINE		
2	5	9999	40MB	0	ON-LINE		
2	6	9999	40MB	0	ON-LINE		
2	8	9999	40MB	NONE	FRMT DRV		

View drive information
Scan scsi drive
set slot Number
add drive Entry
Identify scsi drive
clone Failing drive
disk Reserved space - 256 mb

SCSI Channel 2
SCSI Channel 1
SCSI Channel 1
SCSI Channel 1
SCSI Channel 1
SCSI Channel 7

ID 9
ID 10
ID 11
ID 12
ID 13
ID 14
ID 15

Arrow Keys: Move Cursor | Enter: Select | Esc

Scan SCSI Drive ?
Yes No

If a drive is connected after the array is started, choose a drive and press [ENTER]. Choose "Scan SCSI drive", then press [ENTER]. The menu may vary according to the drive status. Choose the drive channel and ID of the drive you wish to scan, then press [ENTER].

Slot Number

Drive Entry

These two functions are reserved for Fault Bus configuration.

Identifying Drive

Slot	Chl	ID	Size(MB)	Speed	LG_DRV	Status	Vendor and Product ID
2	0	9999	40MB	0	ON-LINE	IBM	DDRS-34560D
2	5	9999	40MB	0	ON-LINE	IBM	DDRS-34560D
2	6	9999	40MB	0	ON-LINE	IBM	DDRS-34560D
2	8	9999	40MB	NONE	NEW DRV	IBM	DDRS-34560D

View drive information
Scan scsi drive
set slot Number
add drive Entry
Identify scsi drive
clone failing drive

flash All drives
flash Selected drive
flash all But selected drive

Move the cursor bar to the drive you wish to identify, then press [ENTER]. Choose "Identify SCSI drive," then choose "flash all drives" to flash the read/write LEDs of all the drives in the drive channel. Choose Yes.

Slot	Chl	ID	Size(MB)	Speed	LG_DRV	Status	Vendor and Product ID
2	0	9999	40MB	0	ON-LINE	IBM	DDRS-34560D
2	5	9999	40MB	0	ON-LINE	IBM	DDRS-34560D
2	6	9999	40MB	0	ON-LINE	IBM	DDRS-34560D
2	8	9999	40MB	NONE	NEW DRV	IBM	DDRS-34560D

View drive information
Scan scsi drive
set slot Number
add drive Entry
Identify scsi drive
clone failing drive

Flash Drive Time(Second) : 15

flash
flash
flash all But selected drive

Flash All But Channel:2 ID:1 SCSI Drive ?
Yes No

You may also choose “flash selected drive” or “flash all But Selected drives” to flash the read/write LED of the selected drive only, or all the drives except the selected drive. Choose **Yes** and choose an extent of time from 1 to 999 seconds.

Deleting Spare Drive (Global / Local Spare Drive)

Move the cursor to a Local Spare Drive or Global Spare Drive, then press [ENTER]. Choose “Delete Global/Local Spare Drive,” then press [ENTER] again. Choose **Yes** to confirm.

	Slot	Chl	ID	Size(MB)	Speed	LG_DRV	Status	Vendor	and Product ID
Quick									
View		2	0	9999	40MB	0	ON-LINE	IBM	DDRS-34560D
View		2	1	9999	40MB	0	ON-LINE	IBM	DDRS-34560D
View		2	2	9999	40MB	0	ON-LINE	IBM	DDRS-34560D
View									
View									
sys									
View									
View									
View drive information									
Delete Global/Local spare drive									
Scan scsi drive									
set slot Number									
add drive Entry									
Identify scsi drive									
Delete Spare Drive ?									
Yes No									
DDRS-34560D									
DDRS-34560D									
2 8 9999 40MB GLOBAL STAND-BY IBM DDRS-34560D									

NOTE:

- The spare drive you deleted or any drive you replaced from a logical unit will be indicated as a "used drive."
-

7.12 Viewing and Editing Channels

Except for those shipped in a dual-redundant chassis, SCSI-based controllers use channel 0 as the host channel and also as the communications path between controllers. If a redundant controller configuration is preferred, you may need to assign other channels as host. Flexibility is added so that all channels can be configured as host or drive.

Cache Status: Clean

```

< Main Menu >
Quick installation
view and edit Logical drives
view and edit logical Volumes
view and edit Host luns
view and edit scsi Drives
view and edit scsi channels
  
```

Chl	Mode	PID	SID	DefSynClk	DefWid	S	Term	CurSynClk	CurWid
0	Host	0	1	40.0MHz	Wide	L	0n	Async	Narrow
1	Host	0	NA	40.0MHz	Wide	L	0n	Async	Narrow
2	Drive	7	NA	40.0MHz	Wide	S	0n	20.0MHz	Wide
3	Drive	7	NA	40.0MHz	Wide	L	0n	Async	Narrow

Arrow Keys:Move Cursor |Enter:Select |Esc:Exit |Ctrl+L:Refresh Screen

Choose “View and Edit Channels” in the Main Menu. Channel status displays.

Redefining Channel Mode

Ch	Mode	PID	SID	DefSynClk	DefWid	S	Term	CurSynClk	CurWid
0	Host	0	1	40.0MHz	Wide	L	0n	Async	Narrow
1	Drive	7	NA	40.0MHz	Wide	L	0n	Async	Narrow
2	Drive	7	NA	40.0MHz	Wide	S	0n	20.0MHz	Wide
3	Drive	7	NA	40.0MHz	Wide	L	0n	Async	Narrow

channel Mode		Change Mode to Host Channel ?	
Primary controller scsi		Yes	No
Secondary controller scs			
scsi Terminator			
sync transfer Clock			
Wide transfer			
View and edit scsi target			
parity check - Enabled			
view chip information			

For Fibre- and SCSI-based controllers, all channels can be operated in host or drive mode. Choose the channel you wish to change, then press [ENTER]. Choose “Channel Mode,” then press [ENTER]. A dialog box will appear asking you to confirm the change.

IMPORTANT!

- *Every time you change the channel mode, you must reset the controller for the change to take effect.*

Viewing and Editing SCSI IDs - Host Channel

Main Menu										
Quick installation	view and edit Logical drives	view and edit Logical Volumes	view and edit Host Luns	view and edit scsi Drives	view and edit Scsi channels					
0	Host	0	1	40.0MHz	Wide	L	0n	Async	Narrow	
	ID 0 (Primary Controller)				Wide	L	0n	Async	Narrow	
2	Add Channel SCSI ID				Wide	S	0n	20.0MHz	Wide	
3	Delete Channel SCSI ID				Wide	L	0n	Async	Narrow	

Choose a host channel, then press [ENTER]. Choose "View and Edit SCSI ID." A list of existing ID(s) will be displayed on the screen. You may then choose to add or delete an existing ID.

Viewing and Editing SCSI IDs

Adding an ID (Primary/Secondary Controller ID)

Main Menu										
Quick installation	view and edit Logical drives	view and edit Logical Volumes	view and edit Host Luns	view and edit scsi Drives	view and edit Scsi channels					
0	Host	0	1	40.0MHz	Wide	L	0n	Async	Nar	
1	ID 0 Primary Controller				Wide	L	0n	Async	Nar	
	ID 1 Secondary Controller				Wide	S	0n	20.0MHz	Wi	
2	Add Channel SCSI ID				Wide	L	0n	Async	Nar	
3	Delete Channel SCSI ID				Wide	L	0n	Async	Nar	

ID	2
ID	3
ID	4
ID	5
ID	6
ID	7
ID	8
ID	9
ID	10
ID	11
ID	12
ID	13
ID	14
ID	15

In single controller mode, you should set the secondary controller's ID to "NA". In dual-controller mode, you need to set an ID for the secondary controller on each of your drive channels.

Press [ENTER] on one of the existing IDs. Choose "Add Channel SCSI ID," then choose to assign an ID for either the "Primary Controller" or "Secondary Controller." A list of SCSI IDs will appear. Choose a SCSI ID. **DO NOT** choose a SCSI ID used by another device on the same channel. The defaults are PID=8 and SID=9 (SCSI channel). In redundant mode, logical drives mapped to a primary ID will be managed by the primary controller, and vice versa.

Deleting an ID

Main Menu										
Quick installation										
view and edit Logical drives										
view and edit Logical Volumes										
view and edit Host luns										
view and edit scsi Drives										
view and edit Scsi channels										
Chl	Mode	PID	SID	DefSynClk	DefWid	S	Term	CurSynClk	CurWid	
0	Host	0	1	40.0MHz	Wide	L	0n	Async	Narrow	
1	ID 0	Delete Secondary Controller SCSI ID 1 ?						ync	Narrow	
2	ID 1	Yes						No	0MHz	Wide
3	Delete Channel SCSI ID			Wide	L	0n	Async	Narrow		

Choose the SCSI ID you wish to delete. Choose "Delete Channel SCSI ID." The dialog box "Delete Primary/Secondary Controller SCSI ID?" will appear. Select **Yes**, then press [ENTER] to confirm.

IMPORTANT!

- Every time you change a channel ID, you must reset the controller for the changes to take effect.
- The default SCSI ID of the primary controller (single controller configuration) on a host channel is 0, on a Drive channel is 7.
- If only one controller exists, you must set the secondary controller's ID to "NA." If a secondary controller exists, you need to set a secondary ID on host and drive channels.
- Multiple target IDs can be applied to the host channels while each drive channel has only one or two (in redundant mode).
- At least one controller's ID has to be present on each channel bus.

Setting a Primary Controller's ID - Drive Channel

Main Menu										
Quick installation										
view and edit Logical drives										
view channel Mode										
view Primary controller scsi id										
view Secondary controller scsi id										
scsi terminator										
sync transfer Clock										
Wide transfer										
View and edit scsi target										
parity check - Enabled										
view chip information										
Chl	Mode	PID	SID	DefSynClk	DefWid	S	Term	CurSynClk	CurWid	
0	Drive	7	NA	40.0MHz	Wide	L	0n	Async	Nar	
1	Change Primary Controller SCSI ID ?						Yes	No		
2	Drive	7	NA	40.0MHz	Wide	L	0n	Async	Nar	
3	Drive	7	NA	40.0MHz	Wide	L	0n	Async	Nar	

ID 0
 ID 1
 ID 2
 ID 3
 ID 4
 ID 5
 ID 6
 ID 7

Choose a drive channel, then press [ENTER]. Choose "Primary Controller ID." A list of channel IDs displays. Choose an ID. The

dialog box “Change Primary Controller ID?” displays. Select **Yes**, then press [ENTER].

For more details on ID settings in redundant mode, please refer to *Chapter 10*.

Setting a Secondary Controller’s ID - Drive Channel

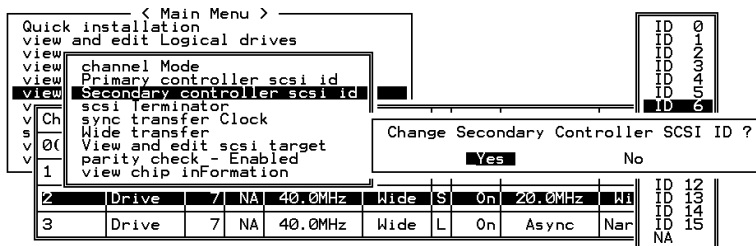

Choose a drive channel, then press [ENTER]. Choose “Secondary Controller ID.” A list of channel IDs displays. Assign an ID to the chip processor of the secondary controller’s drive channel. Choose an ID. The dialog box “Change Secondary Controller ID?” will appear. Select **Yes**, then press [ENTER].

NOTE:

The EonStor subsystems have preset IDs for the drive channels and there is no need to change those IDs. For all subsystems that come with drives attached through back-end PCBs, system vendors should have configured the drive IDs and there is usually no need to make any changes.

Setting Channel Terminator

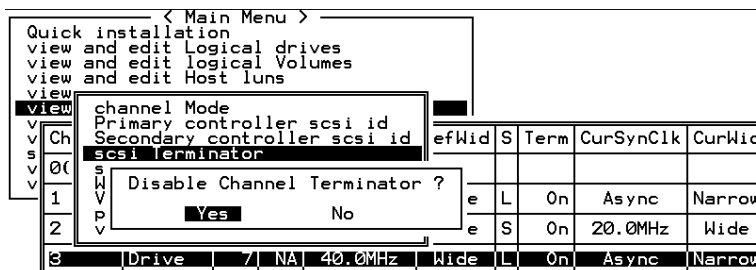

Choose the channel for which you wish the terminator enabled or disabled, then press [ENTER]. Choose “SCSI Terminator”, then press [ENTER]. A dialog box will appear. Choose **Yes**, then press [ENTER]. The terminator can also be enabled by switch jumpers. Please refer to the controller hardware manual for more details.

Setting a Transfer Speed

Drive Channel

Quick installation
view and edit Logical drives
view channel Mode
view view and edit scsi Id
view scsi Terminator
view sync transfer Clock
view Wide transfer
view parity check - Enabled
view view chip inFormation

Ch	Host	0	NA	40.0MHz	Wide	L	On	Async	Nar
2	Drive	7	6	40.0MHz	Wide	S	On	Async	Nar
3	Drive	7	NA	40.0MHz	Wide	L	On	Async	Nar

Change Sync Transfer Clock ?
Yes No

8.0MHz
10.0MHz
13.0MHz
16.0MHz
20.0MHz
26.0MHz
33.0MHz
40.0MHz
Async

Host Channel

Quick installation
view and edit Logical drives
view channel Mode
view Primary controller scsi id
view Secondary controller scsi id
view scsi Terminator
view sync transfer Clock
view Wide transfer
view view and edit scsi target
view parity check - Enabled
view view chip inFormation

Ch	Host	0	NA	80.0MHz	Wide	L	On	Async	Nar
2	Drive	7	NA	80.0MHz	Wide	S	On	20.0MHz	Wide
3	Drive	7	NA	80.0MHz	Wide	L	On	Async	Nar

efWid S Term CurSynClk Cur

Wide L On Async Nar

Wide L On Async Nar

80.0MHz
40.0MHz
33.0MHz
26.0MHz
20.0MHz
16.0MHz
13.0MHz
10.0MHz
8.0MHz
6.7MHz
5.8MHz
5.0MHz
4.0MHz
3.3MHz
3.0MHz
2.5MHz
Async

Move the cursor bar to a channel, then press [ENTER]. Choose "Sync Transfer Clock", then press [ENTER]. A list of the clock speeds will appear. Move the cursor bar to the desired speed and press [ENTER]. A dialog box "Change Sync Transfer Clock?" will appear. Choose Yes to confirm.

IMPORTANT!

Transfer rate	Transfer speed in Mhz
SCSI-320	160Mhz
SCSI-160	80Mhz

- According to SCSI Channel Specifications, transfer speed shown in Mhz is the SCSI bus sync frequency. With 16-bit Wide transfer, the actual data rate is the double of Mhz transfer speed.

- Every time you change the Transfer Speed, you must reset the controller for the changes to take effect.

Setting the Transfer Width

Quick installation
view and edit Logical drives
view channel Mode
view view and edit scsi Id
view scsi Terminator
view sync transfer Clock
view Wide transfer

Ch	Host	0	NA	40.0MHz	Wide	L	On	Async	Narrow
2	Drive	7	6	40.0MHz	Wide	S	On	20.0MHz	Wide
3	Drive	7	NA	40.0MHz	Wide	L	On	Async	Narrow

efWid S Term CurSynClk CurWid

Narrow L On Async Narrow

Enable Wide Transfer ?
Yes No

Move the cursor bar to a channel, then press [ENTER]. Select "Wide Transfer," then press [ENTER]. A dialog box "Disable Wide Transfer?" or "Enable Wide Transfer?" will appear. Choose Yes to confirm.

IMPORTANT!

- Every time you change the SCSI Transfer Width, you must reset the controller for the changes to take effect.

Viewing and Editing SCSI Target / Drive Channel

efWid	S	Term	CurSynClk	CurWid					
arrow	L	0n	Async	Narrow					
2	Drive	7	6	40.0MHz	Wide	S	0n	20.0MHz	Wide
3	Drive	7	NA	40.0MHz	Wide	L	0n	Async	Narrow

Move the cursor bar to a drive channel, then press [ENTER]. Select "View and Edit SCSI Target," then press [ENTER].

Slot	Ch1	ID	SyncClk	XfrWid	ParityChk	Disconnect	TagCount
2	0	10	Wide	Enabled	Enabled	Def (32)	
5				bled	Enabled	Def (32)	
8				bled	Enabled	Def (32)	
9				bled	Enabled	Def (32)	

A list of all the SCSI targets and their current settings will appear. Press [ENTER] on a SCSI target and a menu list will appear on the screen.

NOTE:

- The SCSI target settings should only be altered when adjustments are being made to specific devices on a drive channel. You may change the SCSI parameters for specific drives when mixing different drives or connecting other SCSI devices such as a CD-ROM on a drive channel. Please note that neither mixing drives nor connecting a CD-ROM is recommended for the controller.

Slot Number

Choose "Slot Number", then press [ENTER]. Enter a slot number, then press [ENTER] again.

This setting is reserved for the "Fault-Bus" option.

Maximum Synchronous Transfer Clock

Quick view	Slot	Chl	ID	SyncClk	XfrWid	ParityChk	Disconnect	TagCount	
view	1	0		9	Wide	Enabled	Enabled	Def(32)	
view	Slot number					bled	Enabled	Def(32)	
view	maximum sync. xfer Clock								
v	Ch	Synchronous Transfer Period Factor							2)
s	0	Maximum Sync. Xfer Clock: 9_							2)
v									2)
i		1	5	9	Wide	Enabled	Enabled	Def(32)	
2		1	6	9	Wide	Enabled	Enabled	Def(32)	
3		1	8	9	Wide	Enabled	Enabled	Def(32)	

Choose "Maximum Sync. Xfer Clock," then press [ENTER]. A dialog box will appear on the screen. Enter the clock, then press [ENTER].

Maximum Transfer Width

Quick view	Slot	Chl	ID	SyncClk	XfrWid	ParityChk	Disconnect	TagCount
view	1	1	0	9	Wide	Enabled	Enabled	Def(32)
view	2	1	1	9	Narrow	Enabled	Enabled	Def(32)
view	Slot number					bled	Enabled	Def(32)
v	maximum sync. xfer Clock							
s	maximum xfer width					bled	Enabled	Def(32)
v	Set SCSI Target Maximum Xfer Wide Supported ?							2)
i	Yes							2)
2		1	6	9	Wide	Enabled	Enabled	Def(32)
3		1	8	9	Wide	Enabled	Enabled	Def(32)

Choose "Maximum Xfer Width", then press [ENTER]. Choose Yes in the dialog box to confirm the setting.

Parity Check

Slot	Chl	ID	SyncClk	XfrWid	ParityChk	Disconnect	TagCount
1	1	0		9 Wide	Enabled	Enabled	Def(32)
2	1	1		9 Wide	Disabled	Enabled	Def(32)
0					bled	Enabled	Def(32)
1					bled	Enabled	Def(32)
2					bled	Enabled	Def(32)
3					bled	Enabled	Def(32)
	1	8		9 Wide	Enabled	Enabled	Def(32)

Slot number
 maximum sync. xfer Clock
 maximum xfer Width
 Parity check
 Enable Parity Checking ?
 Yes No

Choose "Parity Check." Choose **Yes** in the dialog box that follows to confirm the setting.

Disconnecting Support

Slot	Chl	ID	SyncClk	XfrWid	ParityChk	Disconnect	TagCount
1	2	0		9 Wide	Enabled	Enabled	Def(32)
2	2	1		9 Wide	Enabled	Enabled	Def(32)
0					bled	Enabled	Def(32)
1					bled	Enabled	Def(32)
2					bled	Enabled	Def(32)
3					bled	Enabled	Def(32)
6					bled	Enabled	Def(32)
7	2	8		9 Wide	Enabled	Enabled	Def(32)

Slot number
 maximum sync. xfer Clock
 maximum xfer Width
 Parity check
 Disconnect support
 Disallow target disconnect ?
 Yes No

Choose "Disconnect Support." Choose **Yes** in the dialog box that follows to confirm the setting.

Maximum Tag Count

Slot	Chl	ID	SyncClk	XfrWid	ParityChk	Disconnect	TagCount
1	2	0		9 Wide	Enabled	Enabled	Def(32)
2	2	1		9 Wide	Enabled	Enabled	Def(32)
0					bled	Enabled	Def(32)
1					bled	Enabled	Def(32)
2					bled	Enabled	Def(32)
3					bled	Enabled	Def(32)
6	2	6		9 Wide	Enabled	Enabled	Def(32)
7	2	8		9 Wide	Enabled	Enabled	Def(128)

Slot number
 maximum sync. xfer Clock
 maximum xfer Width
 Parity check
 Disconnect support
 maximum tag count
 Restore to default setting
 Set Maximum Tag Count ?
 Yes No

Choose "Maximum Tag Count," then press [ENTER]. A list of available tag count numbers will appear. Move the cursor bar to a number, then press [ENTER]. Choose **Yes** in the dialog box that follows to confirm the setting.

IMPORTANT!

- Disabling the Maximum Tag Count will disable the internal cache of a SCSI drive.

Data Rate

Q	ch1	ID	DefSynclK	Defwid	S	Term	CurSynclK	Curwid
V	0	AUTO	*	AUTO	Serial	F	NA	
V	1	33MB	*	AUTO	Serial	F	NA	
V	4	133MB		AUTO	SATA		133MB	SATA
V	5	150MB						
V	6	Information		SATA			133MB	SATA
V	7	Drive		AUTO	SATA		133MB	SATA
V	8	Drive		AUTO	SATA		133MB	SATA
V	9	Drive		AUTO	SATA		133MB	SATA

This option is available in the configuration menu of Fibre host channel and the drive channel configuration menus of Fibre-, ATA-, or SATA-based subsystems. Default is "AUTO" and should work fine with most disk drives. Changing this setting is not recommended unless some particular bus signal issues occur.

The host channel data rate setting allows a 2Gbit Fibre Channel to negotiate with devices communicating over 1GHz link if the link speed configuration is determined externally.

Most SATA/ATA-based systems connect only one drive per SATA/ATA channel (4 for multi-lane with SATA-II). This helps to avoid a single drive failure from affecting other drives. The maximum mechanical performance of today's drives can reach around 30MB/second (sustained read). This is still far below the bandwidth of a drive channel bus. Setting the SATA/ATA bus speed to a lower value can get around some problems, but will not become a bottleneck to system performance.

Note that the SATA/ATA speed is the maximum transfer rate of the SATA/ATA bus in that mode. It does not mean the drive can actually carry out that amount of sustained read/write performance. For the performance of each drive model, please refer to the documentation provided by drive manufacturer.

Issue LIP

```

< Main Menu >
Quick installation
view and edit Logical drives
view and edit logical Volumes

```

Q	ch1	Mode	PID	SID	DefSynclK	Defwid	S	Term	CurSynclK	curwid
V	0	Host	*	NA	AUTO	Serial	F	NA	2 GHz	Serial
V	1	Host	*	NA	AUTO	Serial	F	NA	2 GHz	Serial
V	2	Host	*	NA	AUTO	Serial	F	NA	2 GHz	Serial
V	3	Host	*	NA	AUTO	Serial	F	NA	2 GHz	Serial
V	4	Host	*	NA	AUTO	Serial	F	NA	2 GHz	Serial
V	5	Host	*	NA	AUTO	Serial	F	NA	2 GHz	Serial

```

channel Mode
Primary controller scsi id
Secondary controller scsi id
view chip inFormation
Data rate
Issue lip

```

Issue LIP ?	Yes	No	Hz	Serial
-------------	-----	----	----	--------

```

5(4;C) DRV+RCC 119 120 AUTO Serial F NA 2 GHz Serial

```

This option allows you to manually issue a LIP (Loop Initialization Sequence) on either a host or drive channel. This function is particularly useful when cabling failure occurs between two cascaded drive enclosures.

The condition for applying the “Issue LIP” function is described as follows (see diagram Figure 7-2):

1. Multiple enclosures have been cascaded using FC-AL Fibre links. For example, an EonRAID 2510FS or an A16F-R RAID enclosure connected with several SATA JBODs.
2. One cable link fails or is disconnected between enclosures.
3. Cabling failure is restored.
4. Since the FC port to which the failed link was attached to has already been bypassed at the time when the fault occurred, a LIP command must be manually exerted by the user for the FC port to participate in the loop again. The dual-loop FC-AL can thus be restored.

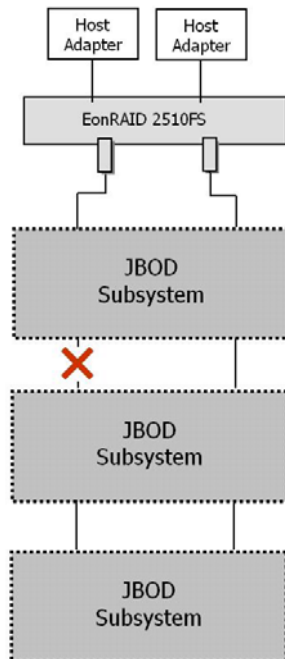
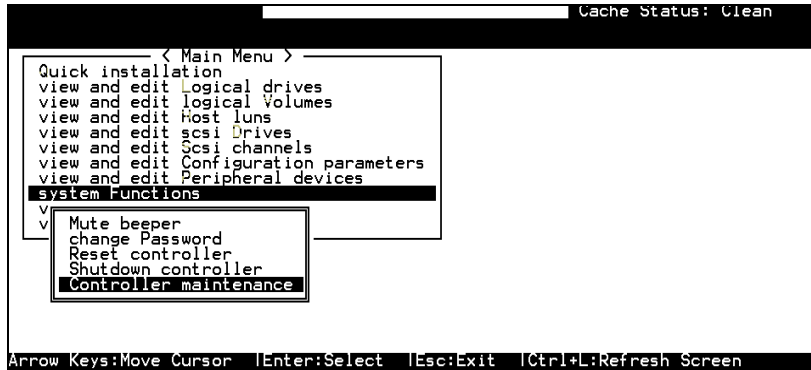

Figure 7 - 2 Cabling Failure between Drive Enclosures

7.13 System Functions



Choose “System Functions” in the Main Menu, then press [ENTER]. The System Functions menu displays. Move the cursor bar to an item, then press [ENTER].

Mute Beeper

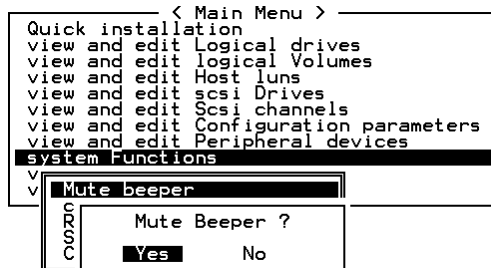

When the controller’s beeper has been activated, choose “Mute beeper,” then press [ENTER]. Choose “Yes” and press [ENTER] in the next dialog box to turn the beeper off temporarily for the current event. The beeper will still be activated on the next event.

Change Password

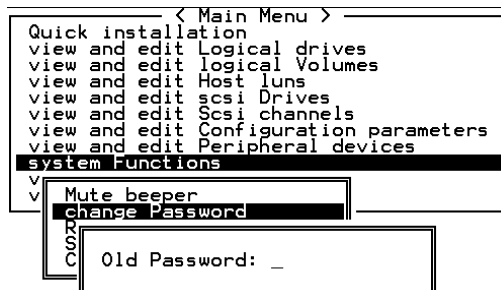

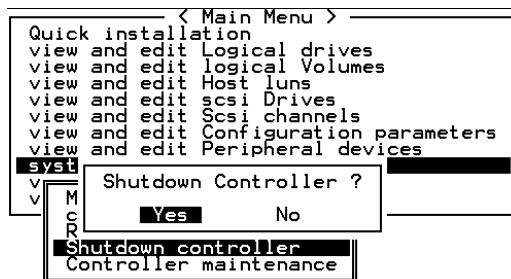

For "Controller Maintenance" functions, such as "Download Firmware," please refer to *Appendix B*.

Adjust LCD Contrast

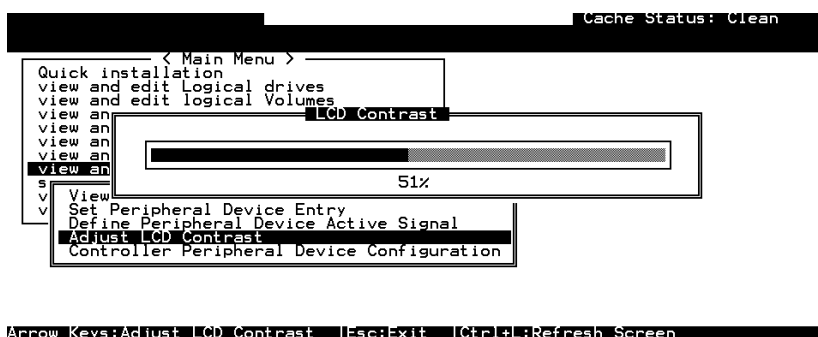

The controller LCD contrast is set at the factory to a level that should be generally acceptable. The controller is equipped with an LCD contrast adjustment circuit, allowing the contrast to be adjusted either via the RS-232 Terminal Emulation Menus or by the LCD User Interface.

7.14 Controller Parameters

Controller Name

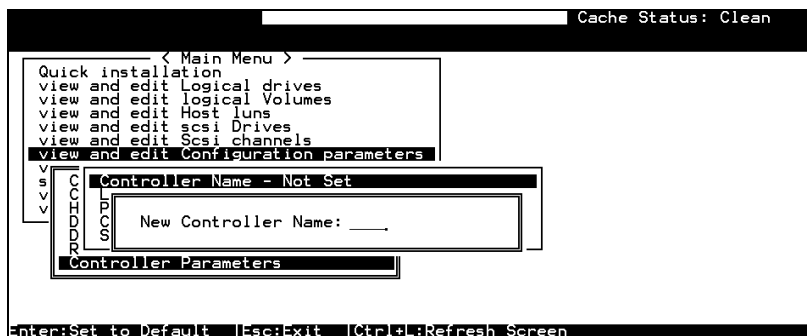

Choose “View and Edit Configuration Parameters,” “Controller Parameters,” then press [ENTER]. The current name displays. Press [ENTER]. Enter a name in the dialog box that prompts, then press [ENTER].

LCD Title Display - Controller Name

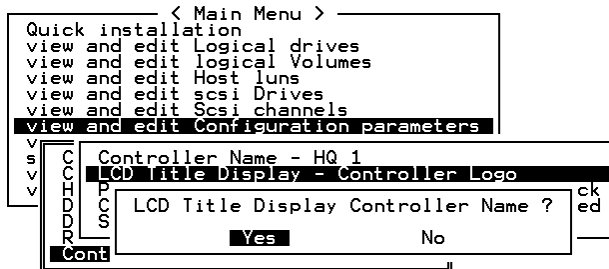

Choose “View and Edit Configuration Parameters,” “Controller Parameters,” then press [ENTER]. Choose to display the embedded controller logo or any given name on the LCD. Giving a specific name to each controller will make them easier to identify if you have multiple RAID systems remotely monitored.

Saving NVRAM to Disks

You can choose to backup your controller-dependent configuration information to disks. We recommend using this function to save configuration information whenever a configuration change is made. The information will be duplicated and distributed to all logical configurations of drives.

At least a RAID configuration must exist for the controller to write your configuration data onto it.

From the Main Menu, choose "System Functions." Use the arrow keys to scroll down and select "Controller Maintenance," "Save NVRAM to Disks," then press [ENTER].

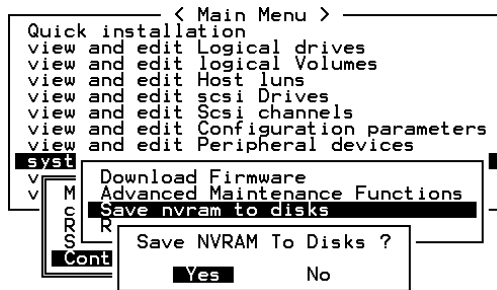

Choose **Yes** to confirm.

A prompt will inform you that NVRAM information has been successfully saved.

Restore NVRAM from Disks

When you want to restore your NVRAM information from what you previously saved onto disk, use this function to restore the configuration information.

From the Main Menu, choose "System Functions." Use the arrow keys to scroll down and select "Controller Maintenance," "Restore NVRAM from disks," and then press [ENTER].

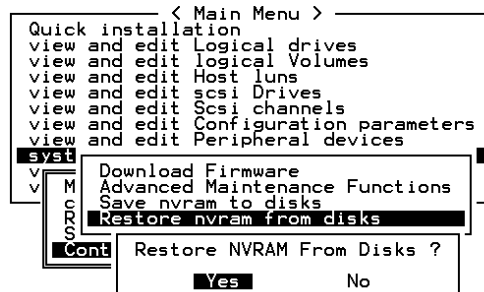

Press **Yes** to confirm.

A prompt will notify you that the controller NVRAM data has been successfully restored from disks.

Password Validation Timeout

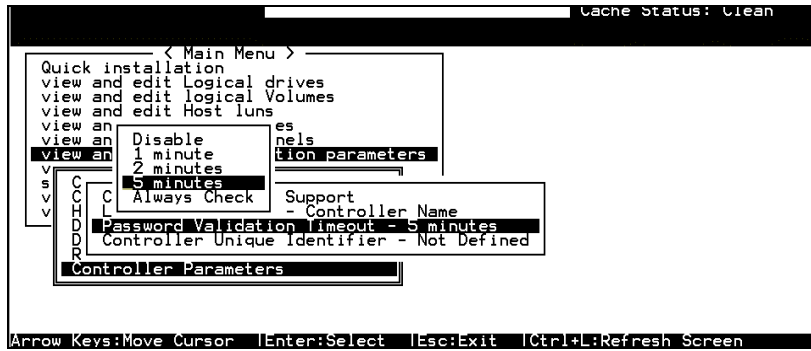

Choose "View and Edit Configuration Parameters," "Controller Parameters," then press [ENTER]. Select "Password Validation Timeout," and press [ENTER]. Choose to enable a validation timeout from one minute to Always Check. The Always Check timeout will disable any configuration change made without entering the correct password.

Controller Unique Identifier



Enter any hex number between “0” and “FFFFF” for the unique identifier. The value you enter *MUST* be different for each controller.

The Controller Unique Identifier is *required* for configuring every RAID controller. The controller automatically notifies users to enter a unique identifier when the first logical drive is created in a dual-controller system.

Enter a unique ID for any RAID controller whether it is configured in a single or dual-controller configuration. The unique ID is necessary for the following:

1. A controller-specific identifier helps controllers to identify their counterpart in a dual-active configuration.
2. The unique ID is generated into a Fibre Channel WWN node name for controllers or RAID systems using Fibre Channel host ports. The node name prevents host computers from mis-addressing the storage system during the controller failover/failback processes.
3. MAC addresses for the controller’s Ethernet port that will be taken over by a surviving controller in the event of single controller failure.

In redundant mode, configuration data is synchronized between controllers. Host ports on the partner controllers appear with the same node name but each has a different port name (WWPN).

When a controller fails and a replacement is combined as the secondary controller, the node name will be passed down to the secondary controller. The host will not acknowledge any differences so that controller failback is totally transparent.

The unique identifier setting can be accessed from "View and Edit Configuration Parameters" ▢ "Controller Parameters" ▢ "Controller Unique ID."

Set Controller Date and Time

This sub-menu only appears when the controller is equipped with a real-time clock.

Time Zone

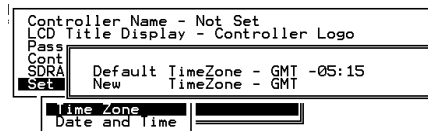

The controller uses GMT (Greenwich Mean Time), a 24-hours clock. To change the clock to your local time zone, enter the hours later than the Greenwich mean time following a plus (+) sign. For example, enter "+9" for Japanese time zone.

Date and Time



Enter time and date in its numeric representatives in the following order: month, day, hour, minute, and the year.

SCSI Drive Read/Write Test

From the "View and Edit SCSI Drives" menu, select a new or used drive that the utility is to be performed on, then press [ENTER]. Select "SCSI Drive Utilities," then press [ENTER]. Choose "Read/Write Test" and press [ENTER]. You can choose to enable/disable the following options:

1. Auto Reassign Bad Block
2. Abort When Error Occurs
3. Drive Test for - Read Only/Read and Write

When finished with configuration, select "Execute Drive Testing" and press [ENTER] to proceed.

Quick view view view view view view view view view view	Slot	Chl	ID	Size(MB)	Speed	LG_DRV	Status	Vendor and Product ID	
	1	2	0	9999	40MB	0	ON-LINE	IBM	DDRS-34560D
	2	2	1	9999	40MB	0	ON-LINE	IBM	DDRS-34560D
	3	2	2	9999	40MB	0	ON-LINE	IBM	DDRS-34560D
								IBM	DDRS-34560D
								IBM	DDRS-34560D
	7	2	6	9999	40MB	NONE	NEW DRV	IBM	DDRS-34560D
	8	2	8	9999	40MB	0	ON-LINE	IBM	DDRS-34560D

The Read/Write test progress will be indicated by a status bar.

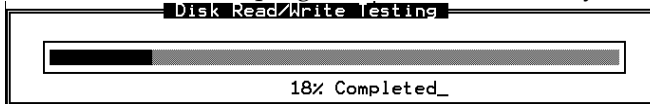

You may press [ESC] and select "Read/Write Test" later and choose either to "View Read/Write Testing Progress" or to "List Current Bad Block Table." If you want to stop testing the drive, select "Abort Drive Testing" and press [ENTER] to proceed.

Quick view view view view view view view view view view	Slot	Chl	ID	Size(MB)	Speed	LG_DRV	Status	Vendor and Product ID	
	1	2	0	9999	40MB	0	ON-LINE	IBM	DDRS-34560D
	2	2	1	9999	40MB	0	ON-LINE	IBM	DDRS-34560D
	3	2	2	9999	40MB	0	ON-LINE	IBM	DDRS-34560D
								IBM	DDRS-34560D
								IBM	DDRS-34560D
	7	2	6	9999	40MB	NONE	NEW DRV	IBM	DDRS-34560D
	8	2	8	9999	40MB	0	ON-LINE	IBM	DDRS-34560D

Bad Block Table											
Address	Stat	Address	Stat	Address	Stat	Address	Stat	Address	Stat	Address	Stat
-											

8.1 Overview

This chapter describes the Fibre-specific functions available since firmware release 3.21 and above. Optional functions have been implemented for operations using Fibre Channel and access control under multiple-host environments such as Storage Area Network. Users familiar with Fibre Channel configurations, please move ahead to *Section 8.5*.

Summary:

8.2 Major Concerns:

Things you should know before proceeding with configuration

8.3 Supported Features:

List of functionality supported by controller FC chips

8.4 Configuration Samples:

Configuration options for data bus setting and system drive mapping

8.5 Configuration: Host and Drive Parameters

The configuration procedures for changing parameters on FC host and drive channels

8.6 Multi-Host Access Control:

Learning how to setup the LUN filtering function, a useful tool for access control in multi-host environments

8.2 Major Concerns

Most of the configuration options in this chapter are directly related to controller redundancy. Joining two controllers into a dual-active pair can eliminate most possible points of failure. Configuring a controller pair requires careful planning and proper setup, the requirements can be summarized as follows:

<p>▪ Redundant Cache Coherency Channels (RCC):</p>	
1. RCC	FC channels can be manually assigned as the dedicated communications loops. Two are recommended for path redundancy and sufficient bandwidth.
2. Drive + RCC	Communications traffic distributed over drive loops
<p>▪ Connection between Controllers:</p>	
	Cabling between controllers, hardware link through a common backplane, Fibre hub or switch (for SAN applications and for those models that do not have bypass chips)
<p>▪ Channel Mode Assignment</p>	
	<p>According to the topological plan, your I/O channels can be designated as:</p> <ul style="list-style-type: none"> • Host • RCC paths • Drive • Drive + RCC
<p>▪ Host Channel Connection Type:</p>	
	<p>This depends on the way your RAID system is connected to the host computer(s). The host connection type can be:</p> <ul style="list-style-type: none"> • FC-AL • Fabric (point-to-point)
<p>▪ Controller Unique ID:</p>	
	This ID will be used to generate Fibre ports' node names, and is necessary for addressing the controller during the controller failover/failback operation.
<p>▪ Dual-Loop:</p>	
1.	Drive-side dual loop provides data path redundancy. Firmware is capable of executing a

	<p>load-sharing algorithm to optimize dual-loop performance.</p> <p>2. Host-side dual loop is passively supported and requires the support of multi-path software on the host computer.</p>
--	--

8.3 Supported Features

Fibre Chip

1Gbit Fibre Channel:

Fibre loops (1 Gbit FC-AL) comply with the following standards:

1. (FC-PH) X2.230:1994
2. (SCSI-FCP) X3.269:1996
3. (FC-AL-2) Project 1133-D rev.6.5
4. (SCSI-2) X3.131-1994
5. Support for sustained 1 Gbit/sec (100MB/sec) transfer rates
6. Each Fibre loop can be independently configured for the connection to host or drive

2Gbit Fibre Channel:

1. Fibre Channel Arbitrated Loop (FC-AL-2) working draft, rev 6.4
2. Fibre Channel Fabric Loop Attach (FC-FLA) working draft, rev 2.7
3. Fibre Channel Private Loop SCSI Direct Attach (FC-PLDA) working draft, rev 2.1
4. Fibre Channel Tape (FC-TAPE) profile, T11/98-124vD, rev 1.13
5. Support Fibre Channel protocol-SCSI (FCP-SCSI)
6. Support Fibre Channel Internet protocol (IP)

Multiple Target IDs

Each 2Gbit channel configured as a host loop supports multiple target IDs in the range of 0 to 125.

Drive IDs:

Supported ways to address a Fibre port include Hard assigned and Soft assigned. The controller supports automatic loop ID assignment on drive channels. A hard loop address ID can be assigned to disk drives by enclosure jumper setting. If the AL_PA configuration on a drive enclosure has been set to a neutral status, physical IDs will be automatically assigned to drives.

In-band Fibre and S.E.S. Support

"SCSI Pass-through" commands are supported over host and drive loops just as they are over SCSI channels. The "in-band Fibre" protocol for packaging "External Interface" protocol commands/responses is supported over host Fibre loops (such as the RAIDWatch Manager). Drive-side S.E.S. device identification, monitoring, and control are likewise supported over drive loops.

8.4 Configuration: Host and Drive Parameters

Channel Mode:

Q	Ch1	Mode	PID	SID	DefSynClk	DefWid	S	Term	CurSynClk	CurWid	
v	0	Host	112	NA	1 GHz	Serial	F	NA			
v	1	Host	NA	113	1 GHz	Serial	F	NA	1 GHz	Serial	
v	2(C)	DRV+RCC	119	118	1 GHz	Serial	F	NA	1 GHz	Serial	
v	3	Drive	119	118	1 GHz	Serial	F	NA			
v	4	channel Mode					erial	F	NA	1 GHz	Serial
v	5	Host Drive RCCOM Drive+RCCOM					erial	F	NA		

All Fibre Channels can be changed to operate as "Host," "Drive," "RCCOM," or "Drive + RCCOM". Choose the channel for which you wish to change its mode, then press [ENTER]. Choose "Channel Mode," then press [ENTER]. A dialog box will appear asking you to confirm the change.

Primary and Secondary Controller IDs:

Select a channel by highlighting its status bar and press [ENTER].

Drive Channel In redundant controller mode, each drive channel should be assigned with both a "Primary Controller ID" and a "Secondary Controller ID." The factory defaults for the primary and secondary IDs on drive loops are "119" and "120" respectively.

Host Channel Create host IDs on each specific host channel. Host IDs are designated as the "Primary Controller" or "Secondary Controller" IDs.

< Main Menu >											
Quick installation view and edit Logical drives view and edit logical Volumes											
Q	Ch1	Mode	PID	SID	DefSynClk	DefWid	S	Term	CurSynClk	Cur	
v	0	Host	NA	NA	1 GHz	Serial	F	NA	1 GHz	Sen	
v	1	No SCSI ID Assignment - Add Channel SCSI ID ?								GHz	Ser
v	2	Yes				No				GHz	Ser
v	3(2)	Drive	11	Primary Controller				NA	1 GHz	Ser	
v	6(D)	RCCOM		Secondary Controller							
v	7(C)	RCCOM									

<To Range 5>	
ID	96
ID	97
ID	98
ID	99
ID	100
ID	101
ID	102
ID	103
ID	104
ID	105
ID	106
ID	107
ID	108
ID	109
ID	110
ID	111
<To Range 7>	

Limitation:

1. If host connection is made in FC-AL mode, there can be a total of "16" Primary and Secondary IDs.
2. Although host connection in point-to-point mode is supported, problems might occur when passing IDs of the failed controller to its counterpart. HA (Host Adapter) failover software is required in this situation to redirect I/O access during the controller failover operation.

Redundant Controller Cache Coherency Channel (RCC Channel)

A host channel can be selected and converted into a communications channel. To convert a drive channel, change it into host mode and then select "RCCOM." Details can be found in the preceding discussions.

View Channel WWN

The screenshot shows a menu with the following options:

- < Main Menu >
- Quick installation
- view and edit Logical drives
- view and edit logical Volumes
- u
- 0
- 1
- 2<
- 3<
- 6<D>
- 7<D>

The table below shows the channel configuration details:

Ch1	Mode	PID	SID	DefSynClk	DefWid	S	Term	CurSynClk	CurWid
0	Host	0	NA	1 GHz	Serial	F	NA	1 GHz	Serial
1	channel Mode						NA	1 GHz	Serial
2<	view and edit scsi Id						NA	1 GHz	Serial
3<	view chip inFormation						NA	1 GHz	Serial
6<D>	view channel Wwn						NA	1 GHz	Serial
7<D>	RCCom								

Below the table, the WWN and WWPN values are displayed:

- WWN: 20 00 00 D0 23 00 00 01
- WWPN: 21 00 00 D0 23 00 00 01

Port name is a unique eight-byte address assigned to an FC device port.

The controller has multiple channels (I/O paths) and each channel is managed by an I/O processor. This function allows users to inspect the node name and port name assigned to these chip processors. Some management software running on host computers needs these names to properly address a storage subsystem.

View Device Port Name List (WWPN)

```

    < Main Menu >
    Quick installation
    view and edit Logical drives
    view and edit logical Volumes
  
```

Chl	Mode	PID	SID	DefSynClk	DefWid	S	Term	CurSynClk	CurWid
0	Host	0	NA	1 GHz	Serial	F	NA	1 GHz	Serial
1	channel Mode						NA	1 GHz	Serial
2	view and edit scsi Id						NA	1 GHz	Serial
3	view chip information						NA	1 GHz	Serial
3	view channel Wwn						NA	1 GHz	Serial
3	View device: port name list <wwpn>						NA	1 GHz	Serial
6(D)	20 00 00 E0 8B 00 9F 6C								
7(D)	RCCom								

This function displays the device port names (host adapter ID) detected on a host loop.

The HBA port names detected can be added to the "Host-ID WWN name list" in "View and Edit Host LUN" menu. Adding port names to the list can speed the mapping process that follows.

Each port name should then be assigned a nickname for ease of identification. This is especially important when multiple filtering entries must be defined for granting or denying access to a specific storage unit. See the following sections for more details.

View and Edit Fibre Drive

Cache Status: 24% Dirty

Slot	Chl	ID	Size(MB)	Speed	LG_DRU	Status	Vendor and Product ID
2	0	8683	100MB	0	ON-LINE	SEAGATE ST39103FC	
View drive information							0 ON-LINE SEAGATE ST39103FC
Scan scsi drive							0 ON-LINE SEAGATE ST39103FC
set slot Number							0 ON-LINE SEAGATE ST39103FC
add drive Entry							0 ON-LINE SEAGATE ST39103FC
Identify scsi drive							0 ON-LINE SEAGATE ST39103FC
clone Failing drive							0 ON-LINE SEAGATE ST39103FC
disk Reserved space - 32 mb							0 ON-LINE SEAGATE ST39103FC
2	5	8683	100MB	1	ON-LINE	SEAGATE ST39103FC	
2	6	8683	100MB	1	ON-LINE	SEAGATE ST39103FC	
2	7	8683	100MB	1	ON-LINE	SEAGATE ST39103FC	

Arrow Keys:Move Cursor |Enter:Select |Esc:Exit |Ctrl+L:Refresh Screen

Choose "View and Edit SCSI Drives" on the Main Menu and use the arrow keys to move the cursor bar through the connected drives. Press [ENTER] to choose a drive, or [ESC] to return to the previous menu/screen.

User-Assigned ID (Scan SCSI Drive)

Select "Scan SCSI drive" to assign an ID to a drive.

Slot	Chl	ID	Size(MB)	Speed	LG_DRU	Status	Vendor and Product ID
	2	0	17560	100MB	0	ON-LINE	SEAGATE ST318304FC
	2	1	17560	100MB	1	ON-LINE	SEAGATE ST318304FC
	2	2	17560	100MB	NONE	FRMT DRU	SEAGATE ST318304FC
	2	3	17560	100MB	NONE	FRMT DRU	SEAGATE ST318304FC
	SCSI Channel 2		6	100MB	NONE	FRMT DRU	SEAGATE ST318275FC
	Input Fibre ID:			NONE	FRMT DRU	SEAGATE ST318275FC	
				NONE	FRMT DRU	SEAGATE ST318275FC	
	2	7	17366	100MB	NONE	FRMT DRU	SEAGATE ST318275FC

A drive enclosure usually has drive slots pre-assigned with specific IDs. There are occasions when an ID needs to be assigned manually to a device. The "set slot number" and the "add drive entry" functions are reserved for Infortrend's Fault-bus operation.

View Drive Information

Slot	Chl	ID	Size(MB)	Speed	LG_DRU	Status	Vendor and Product ID
	2	0	17560	100MB	0	ON-LINE	SEAGATE ST318304FC
	View drive information		1			ON-LINE	SEAGATE ST318304FC
	Revision Number			0002			8304FC
	Serial Number			3EL00FUN00007049			
	Disk Capacity (blocks)			35964300			8304FC
	Node Name(MVNN)			20 00 00 20 37 65 7B DA			
	Redundant Loop ID			0			8275FC
	2	5	17366	100MB	NONE	FRMT DRU	SEAGATE ST318275FC
	2	6	17366	100MB	NONE	FRMT DRU	SEAGATE ST318275FC
	2	7	17366	100MB	NONE	FRMT DRU	SEAGATE ST318275FC

If the selected drive belongs to a drive group that is configured in a dual-loop, the "Redundant Loop ID" will be displayed here.

View and Edit Host-side Parameters

Cache Status: Clean	
Main Menu	
Quick installation	
view	Maximum Queued I/O Count - 256
view	LUNs per Host SCSI ID - 8
view	Max Number of Concurrent Host-LUN Connection - 32
view	Number of Tags Reserved for each Host-LUN Connection - Def(32)
view	Peripheral Device Type Parameters
view	Host Cylinder/Head/Sector Mapping Configuration
v	Fibre Connection Option - Loop only
C	
s	Host Loop only
v	Drive Point to point only
v	Disk Loop preferred, otherwise point to point
v	Redu Point to point preferred, otherwise Loop
v	Cont

Arrow Keys: Move Cursor | Enter: Select | Esc: Exit | Ctrl+L: Refresh Screen

1. Fibre Channel Connection Option:

Use the ↑↓ keys to scroll down to "View and Edit Configuration Parameters," "Host-side SCSI Parameters," and then "Fibre Connection Option." A prompt will display all the options. Select one appropriate for your Fibre Channel topology. If the connection to the host is through a Fibre hub, choose "Loop only."

If connection to the host is through a Fibre switch F_Port or directly to a server, choose "Point to point only." Proper selection is necessary and will decrease overhead on data transmission.

A redundant controller configuration should always have its host connection configured in FC-AL mode. For a switched fabric configuration, a redundant controller system can be connected to the FL_ports on an FC switch and then the host computers connect to its F_ports.

IMPORTANT!

- *Note that the host ports between redundant controllers can be connected via switched fabric. However, switch ports connecting the controllers should be operating as FL_Ports. If they are configured as F_Ports, the controller host ports will not support multiple target IDs, especially when IDs on a failed controller's host ports need to be taken over by the surviving controller.*
-

View and Edit Drive-side Parameters

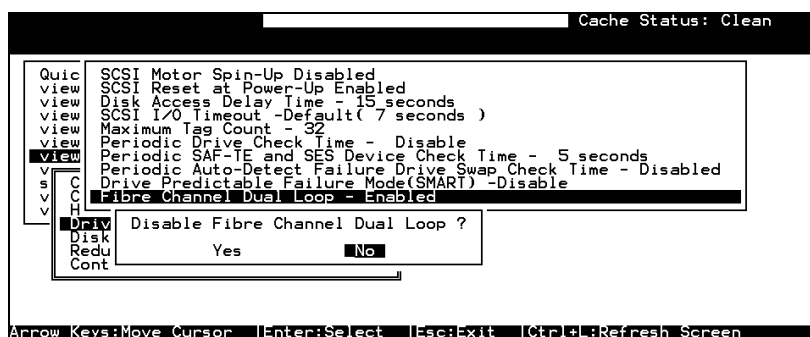

2. Drive-side Dual Loop

Fibre drives are usually configured in a JBOD enclosure. Through the enclosure backplane, these drives form one or two circuit loops. You may choose to assemble a certain number of disk drives into a dual-loop configuration using two of the controller channels.

To configure a dual-loop, connect two of the drive channels each to an FC-AL port on the drive enclosure (JBOD). Please refer to the related documents that came with your drive enclosure for the connection details.

The dual-loop configuration not only doubles traffic bandwidth by separating the transmitting and receiving paths but also provides path redundancy. I/O traffic will be continued if one data path fails.

Controller firmware automatically examines the node names and port names of all the connected drives once initiated. If devices on two different drive channels appear with the same loop ID and port name, the controller will consider these two drive channels as a "dual loop."

< Main Menu >										
Quick installation view and edit Logical drives view and edit logical Volumes										
Ch1	Mode	PID	SID	DefSynClk	DefWid	S	Term	CurSynClk	CurWid	
0	Host	0	NA	1 GHz	Serial	F	NA	1 GHz	Serial	
1	Host	NA	1	1 GHz	Serial	F	NA	1 GHz	Serial	
2<3>	Drive	119	120	1 GHz	Serial	F	NA	1 GHz	Serial	
3<2>	Drive	119	120	1 GHz	Serial	F	NA	1 GHz	Serial	
6<C>	RCCom									
7<C>	RCCom									

The dual loop configuration will be displayed as "channel <pair channel>." For example, channel numbers are displayed as 2<3> and 3<2> if channel 2 and channel 3 are configured as a dual loop. The data bus will be operating at the bandwidth of up to 400MB/sec (2Gbps Fibre).

Controller Unique Identifier

```

Fri Mar 5 11:13:11 2004 Cache Status: Clean

< Main Menu >
Quick installation
view and edit Logical drives
view and edit logical Volumes
view and edit Host luns
view and edit scsi Drives
view
view Controller Name - Not Set
view Set Telnet Inactivity Timeout Time - Disabled (Default)
view LCD Title Display - Controller Name
view Password Validation Timeout - Always Check
view Controller Unique Identifier (Hex) - FFF
view
view Controller Unique Identifier (Hex): FFF
cont
Enter:Set to Default |Esc:Exit |Ctrl+L:Refresh Screen

```

A Controller Unique Identifier is *required* for operation with the *Redundant Controller Configuration*. The controller will automatically notify users to enter a unique identifier when the first logical drive is being created in a dual-controller system.

The unique identifier will be used to generate a Fibre Channel "node name" (WWNN). The node name is device-unique and comprised of information such as the IEEE company ID and this user-configurable identifier in the last two bytes.

In redundant mode, the controller configuration data is continuously synchronized between controllers. Host ports on both controllers appear with the identical node names and each with a different port name (WWPN). When a controller fails and a replacement is combined, the node name will be passed down to the replacement, making the host unaware of controller replacement so that controller failback is totally transparent.

Choose "View and Edit Peripheral Devices," "Set Peripheral Device Entry," then enable the "Redundant Controller" configuration. You will be requested to enter a value for the "Controller Unique Identifier." For firmware release 3.25 and above, enter a hex number between 0 and FFFFF. The identifier selection box will prompt automatically. The value you enter *MUST* be different for each controller.

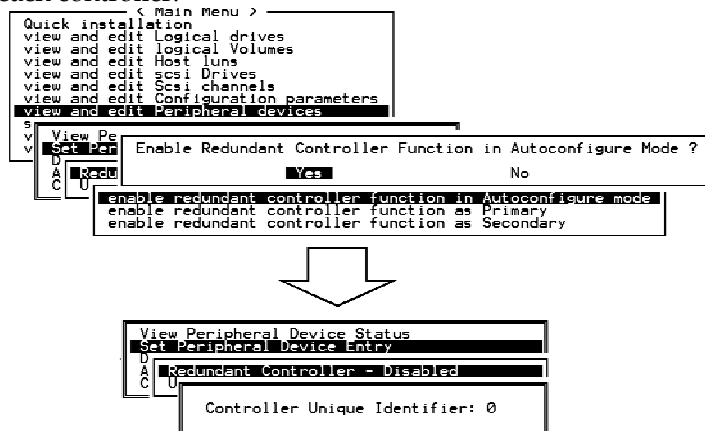

The unique identifier can also be accessed from "View and Edit Configuration Parameters" > "Controller Parameters" > "Controller Unique ID."

Controller Communications over Fibre Loops

Q	Ch1	Mode	PID	SID	DefSynC1k	DefWid	S	Term	CurSynC1k	CurWid
v	0	Host	112	NA	1 GHz	Serial	F	NA		
v	1	Host	NA	113	1 GHz	Serial	F	NA	1 GHz	Serial
v	2(C)	DRV+RCC	119	118	1 GHz	Serial	F	NA	1 GHz	Serial
v	3	Drive	119	118	1 GHz	Serial	F	NA		
v	4	channel Mode				erial	F	NA	1 GHz	Serial
v	5	Host Drive RCCOM Drive+RCCOM			er scsi id ller scsi id ation	erial	F	NA		

Controllers running firmware version 3.14 and above supports controller communications over Fibre loops.

There are two options for controller communications over Fibre loops. Hardware configuration should be completed before firmware setting.

1. Select from the Main Menu "View and Edit SCSI channels," and configure the selected FC channels into "RCCOM (Redundant Controller Communication)" mode. To ensure the connection with data path redundancy, you may use two channels as the dedicated RCC loops. The dedicated channels should not be attached with any other device.
2. **Communications Traffic Distributed over All Drive Loops:** Select all drive loops and configure them as "Drive + RCCOM (Drive Loops plus Redundant Controller Communications)." The communications traffic between the two controllers will be automatically distributed over all drive loops.

Q	Ch1	Mode	PID	SID	DefSynClk	DefWid	S	Term	CurSynClk	CurWid
v	0	Host	112	NA	1 GHz	Serial	F	NA	1 GHz	Serial
v	1	Host	NA	113	1 GHz	Serial	F	NA	1 GHz	Serial
v	2(3;C)	DRV+RCC	119	118	1 GHz	Serial	F	NA	1 GHz	Serial
v	3(2;C)	DRV+RCC	119	118	1 GHz	Serial	F	NA	1 GHz	Serial
v	4(5;C)	DRV+RCC	119	118	1 GHz	Serial	F	NA	1 GHz	Serial
v	5(4;C)	DRV+RCC	119	118	1 GHz	Serial	F	NA	1 GHz	Serial

- As displayed above, channel(s) selected as the communications paths will be displayed as "channel number (C: connected)" or "channel number (D: disconnected)." If channels configured in a dual-loop are selected, channel status will be displayed as "channel number (pair loop; C or D)."
- If any of the communications loops fail, the inter-controller traffic will automatically shift to the remaining Drive/RCC loop(s).

8.5 Multi-host Access Control: LUN Filtering

RAID-based mapping provides access control over a Storage Area Network where:

1. Servers may share common storage
2. File integrity becomes a problem and access contentions might occur
3. File access must be coordinated among multiple servers

Figure 8 - 1 Storage Pool

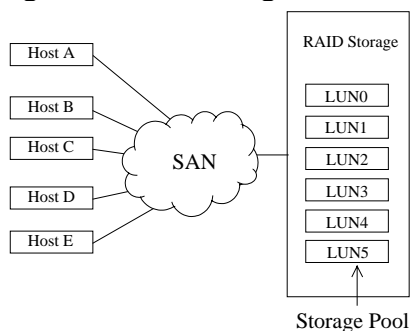

RAID-based mapping provides centralized management for host-storage access. It is derived from the concept that storage can be divided into manageable pieces by mapping storage units to different Logical Unit Numbers (LUNs). The storage can then be managed in the context of a LUN map. We then append filtering mask(s) to the LUNs making a specific storage unit accessible or inaccessible to one or multiple host bus adapters (HBAs).

Figure 8 - 2 Host-LUN Mapping

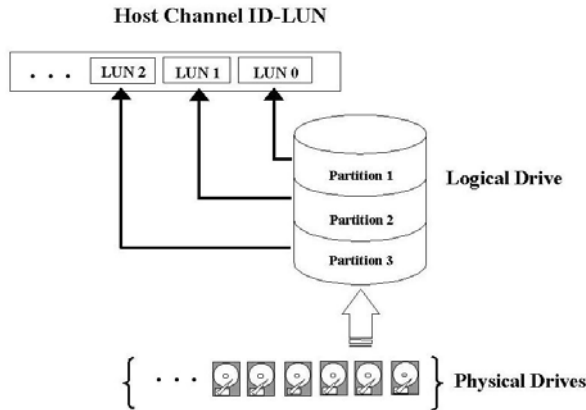

Creating LUN Masks

Users can configure the storage subsystem to appear as 32 LUNs per Fibre target ID. Each LUN can be mapped with a storage unit -a partition or the entire logical drive. The configuration of logical units depends on host applications and how many drives and drive channels have been employed in the storage system.

The diagram below shows the idea of the virtual connection and the physical connection from host computers to drives. There can be many host computers connected across a storage network, and a system administrator may want to make each a storage unit available for certain host systems but forbidden for others.

Figure 8 - 3 LUN Mask

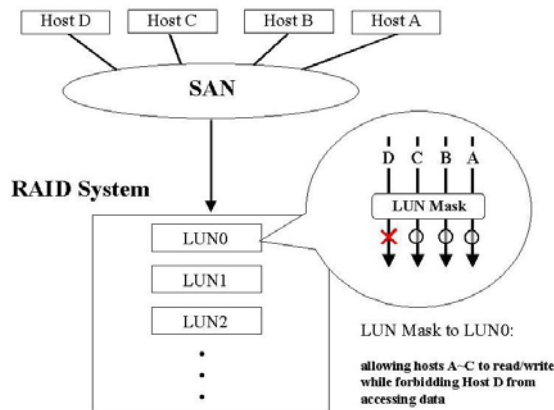

The access control can also be implemented by filter drivers. Compared to the control by software, access control based on controller LUN mapping can avoid server overheads and the additional I/O latency.

The LUN map combines **Host ID** (for Fibre, a 64-bit "port name;" for SCSI, the **initiator ID**) with the list of attributes of a LUN map

that originally only consisted of the channel, target ID, and the LUN number.

To create LUN masks, select "View and Edit Host LUNs" from the Main Menu, then select a host data path (channel-ID combination). In active-to-active mode, selecting a host channel means selecting either the Primary or the Secondary Controller I/O path.

WWN Name List

Before mapping host LUNs, you may add host adapter port names to a WWN name list to combine with a nickname given to each adapter. Names will be recorded in controller NVRAM.



A named adapter (by location or the nature of host applications) can be easily identified and later combined with filtering masks.

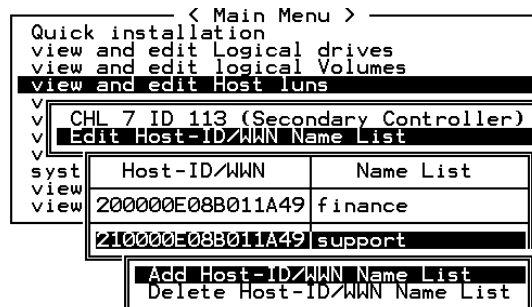

Logical Unit to Host LUN Mapping

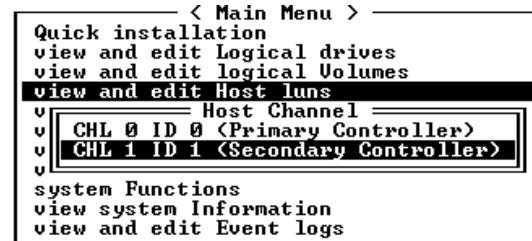

Assign Logical Unit Numbers (LUNs) to logical units (logical drives/logical volumes/logical partitions). Select a host channel/ID and then select a LUN. Select a Host LUN and associate a logical unit with it.

< Main Menu >						
Quick installation	LUN	LU/LD	DRU	Partition	Size(MB)	RAID
view and edit Logical drives	0	LD	1	0	3000	RAID5
view and edit logical Volumes	1	LD	1	1	3000	RAID5
view and edit Host luns	2	LD	3	0	3000	RAID5
Host Channel	3	LD	3	1	3000	RAID5
CHL 0 ID 0 (Primary Control)						
CHL 1 ID 1 (Secondary Control)						
Partition	Offset(MB)	Size(MB)				
0	0	3000				
L	1	3000	3000	atus	0	#LN #SB #FL NAME
S1	526D21EF NA	RAID5	6000	GOOD	S	4 0 0
S3	1B6F245E NA	RAID5	6000	GOOD	S	4 0 0

When a logical unit is selected, you may choose to "Map Host LUN" or "Create Host Filter Entry." If you select to map the logical unit directly to a host LUN without LUN masking, the particular logical unit will be accessible for all host computers connected through the network.

LUN	LU/LD	DRU	Partition	Size(MB)	RAID
0	LD	1	0	3000	RAID5
1	LD	1	1	3000	RAID5
2	LD	3	0	3000	RAID5
3	LD	3	1	3000	RAID5
4					
Map Host LUN					
Create Host Filter Entry					
Add from current device lists					
Manual add host filter entry					
7					

If you want the logical unit to be accessible for some host computers while inaccessible for some others, choose "Create Host Filter Entry." More than one filter entry can be appended to a host LUN to compose a more complex mapping scheme. The LUN map is port name-oriented. You can choose to "Add from current device list" or "Manual(ly) add host filter entry."

LUN	LU/LD	DRU	Partition	Size(MB)	RAID
0	LD	1	0	3000	RAID5
1	LD	1	1	3000	RAID5
2	LD	3	0	3000	RAID5
3	LD	3	1	3000	RAID5
4					
Map Host LUN					
Create Host Filter Entry					
Port Name List					
10 00 00 00 C9 20 C7 38					
7					

Pressing [ENTER] on "Add from current device list" will bring forth a list of port names detected on host loops. If you have a name list pre-configured, port names will appear with their nicknames. Select a port name by pressing [ENTER].

LUN	LV/LD	DRV	Partition	Size(MB)	RAID
0					
Map Host LUN					
Create Host Filter Entry					
Host-ID/WWN					
Host-ID/WWN: 0x200000E08B011A49 (finance)					
Host-ID/WWN: 0x210000E08B011A49 (support)					
Host-ID/WWN: 0x220000E08B011A50 (R&D)					
5					
6					
7					

Host-ID/WWN: 0x210000E08B011A49 (support)	
<input checked="" type="radio"/> Yes	<input type="radio"/> No

Choose Yes to proceed.

LUN	LV/LD	DRV	Partition	Size(MB)	RAID
M 0	LV	1	0	2020	-----
M 1	Logical Volume 1 Partition 4				
M 2	Host-ID/WWN - 0x210000E08B011A49				
M 3	Host-ID/WWN Mask- 0xFFFFFFFFFFFFFFFF				
M 4	Filter Type - Include				
M 5	Access Mode - Read/Write				
M 6	Name - Not Set				
Create Host Filter Entry					
6					
7					

The next step is to edit Host ID/WWN Mask. Move the cursor bar through the menu items and press ENTER on the "Host ID/WWN Mask."

LUN Mask (ID Range) Configuration:

Ranges can be established by combining a basis ID with a mask similar to the way routing table entries are set up on a LAN/WAN. If the port name ID "AND'ed" with the mask equals the basis ID AND'ed with the mask, then the port name ID is considered to fall within the range. If a default value "0xFFFFFFFFFFFFFFFF" is selected, then the port name ID must match the basis ID for the port name to be considered to fall within the range. "0x" means that all values are presented in hexadecimal. If, for instance, a value "0xFFFFFFFFFFFFFFC" is selected, and the basic ID is "0x1111111111111111," port name IDs ranging from "0x....1110" to "0x....1113" will fall in the ID range.

As the general rule, a host HBA's port name can be used as the basic ID. If a host adapter's port name is used as the basic ID and the default mask value, "0xFFFFFFFFFFFFFFFF," is applied, the host will fall exactly within the ID range for the port name ID AND'ed with mask equals the basic ID AND'ed with mask.

Filter Type: Include or Exclude

Filter entry can serve both ends: to include or exclude certain adapters from data access.

Include: If a node's (a workstation or a server) WWN falls in an ID range specified as "Include," the node will be allowed to access the storage capacity mapped to the associated LUN. The access mode can be "read only" or "read/write."

Exclude: If a node's WWN falls in an ID range specified as "Exclude," the node will not be allowed to access the storage capacity mapped with this entry.

Multiple ranges, or filter entries, can be established for a single channel, target-ID, and LUN combination. Each range can have its own Exclude/Include attributes. The rules for determining whether a particular ID is considered as "included" or "excluded" are listed below:

1. If an ID falls within one or more Include ranges and does not fall in any Exclude range, then it is included.
2. If an ID falls within ANY Exclude range no matter if it also falls in another Include range, then it is excluded.
3. If the ID falls in none of the ranges and there is at least one Include range specified, then the ID should be considered as excluded.
4. If the ID falls in none of the ranges and only Exclude ranges are specified, then the ID is considered as included.

Access Mode: Read Only or Read/Write

A particular extended LUN map can be setup with an attribute of "Read Only" in the event that certain hosts may need to read the data on the media but must not be allowed to change it. In the degenerate case (range only includes a single ID), different hosts can be mapped with completely different logical drives/logical volumes/logical partitions even when they address the same channel, target-ID, and LUN.

When LUN mask configuring is completed, press [ESC] to map a logical unit to LUN.

LUN	LU/LD	DRU	Partition	Size(MB)	RAID
Map	Logical Drive: 1			00	RAID5
To	Partition : 1			00	RAID5
	Channel : 1			00	RAID5
	ID : 1			00	RAID5
	Lun : 4		?	00	RAID5
	Yes	No		00	RAID5
4					
5					
6					
7					

Multiple filter entries can be created for a Host ID/LUN combination; select the Host ID/LUN again to enter the editing menu.

LUN	LU/LD	DRU	Partition	Size(MB)	RAID
0	LD	1	0	3000	RAID5
1	LD	1	1	3000	RAID5
2	LD	3	0	3000	RAID5
3	LD	3	1	3000	RAID5
4					
View Host Filter Information					
Map					
Create					
Add Host Filter Entry					
Delete Host Filter Entry					
Host ID - 0x10000000C920C738					
7					

You may continue to add more entries, to delete or edit the existing entries.

Sample Configuration

Figure 8 - 4 LUN Filtering - Configuration Sample

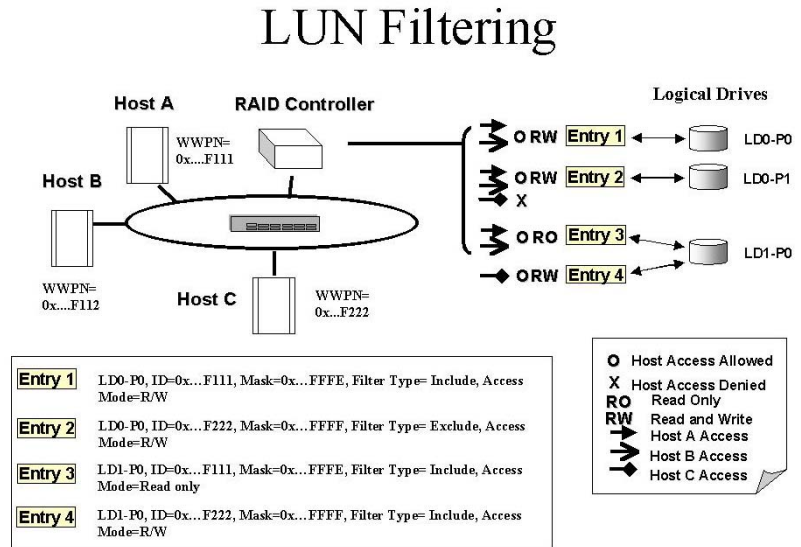

- Host HBA Port Name (WWPN) list
 - Host A = 0x...F111
 - Host B = 0x...F112
 - Host C = 0x...F222

2. Controller Configuration:

- Logical drives are LD0 and LD1. LD0 is partitioned into two: P0 and P1.
- Filter Entry (LUN map) list

Configuration Procedure:

1. Create an entry list for the specific logical unit from "View and Edit Host LUN"\Host Channel\Create Host Filter Entry."
2. Select Host Channel ID, and then select a configured logical unit (a logical drive, logical volume, or one of its logical partitions) to create the entry. The entry submenu will appear.
3. Enter and modify the **Host ID, Host ID Mask, Filter Type, and Access Mode.**

The example entry list is shown below. Please refer to the diagram above.

Entry 1: "LD0-P0, ID=0x...F111, Mask=0x...FFFE, Filter Type = Include, Access Mode = Read/Write." It means Host A and B can read/write P0 of LD0.

Entry 2: "LD0-P1, ID=0x...F222, Mask=0x...FFFF, Filter Type = Exclude, Access Mode = Read/Write." It means Host A and B can read/write P1 of LD0, but this partition is inaccessible for Host C.

Entry 3: "LD1-P0, ID=0x...F111, Mask=0x...FFFE, Filter Type = Include, Access Mode = Read Only." It means P0 of LD1 is 'Read Only' for Host A and B.

Entry 4: "LD1-P0, ID=0x...F222, Mask=0x...FFFF, Filter Type = Include, Access Mode = Read/Write." It means Host C can read/write P0 of LD1.

Host-side and Drive-side Parameters

This chapter discusses the advanced options for configuring and maintaining a RAID system. Each function is given a brief explanation as well as a configuration sample. Terminal screens are used in the configuration samples. Some of the operations require basic knowledge of RAID technology and are only recommended for an experienced user.

9.1 Host-side Parameters

Foreword: SCSI Channel, SCSI ID, and LUN

A SCSI channel (SCSI bus) can connect up to 15 devices (not including the controller itself) when the Wide function is enabled (16-bit SCSI). It can connect up to 7 devices (not including the controller itself) when the Wide function is disabled (8-bit SCSI). Each device has one unique SCSI ID. Two devices contending for the same SCSI ID are not allowed.



Figure 9 - 1
SCSI ID/LUNS

Figure 9-1 illustrates this idea. If you file a document into a cabinet, you must put the document into one of the drawers. From a SCSI's point of view, a SCSI ID is like a cabinet, and the drawers are the LUNs (Logical units). Each SCSI ID enables up to 32 LUNs. Data can be stored into one of the LUNs of the SCSI ID. Most SCSI host adapters treat a LUN like another SCSI device.

The same holds true for a Fibre Channel host interface. Up to 32 LUN's are supported with each host ID and up to 1024 LUNs are configurable per controller.

Maximum Concurrent Host LUN Connection (“Nexus” in SCSI)

The configuration option adjusts the internal resources for use with a number of current host nexus. If there are four host computers (A, B, C, and D) accessing the array through four host IDs/LUNs (ID 0, 1, 2 and 3), host A through ID 0 (one nexus), host B through ID 1 (one nexus), host C through ID 2 (one nexus) and host D through ID 3 (one nexus) - all queued in the cache - that is called 4 nexus. If there are I/Os in the cache through four different nexus, and another host I/O comes down with a nexus different than the four in the cache (for example, host A access ID 3), the controller will return "busy." Note that it is "concurrent" nexus; if the cache is cleared up, it will accept four different nexus again. Many I/Os can be accessed via the same nexus.

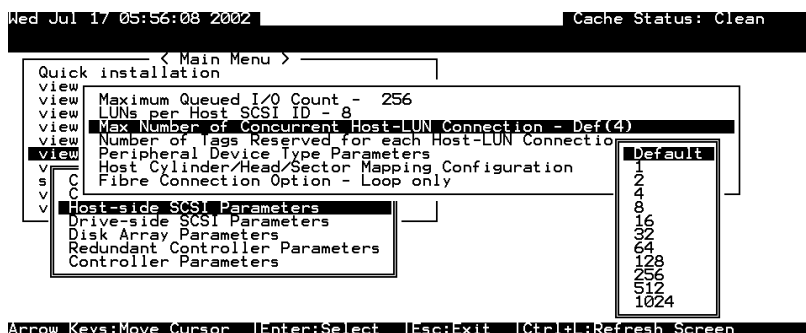

From the Main Menu, select “View and Edit Configuration Parameters,” “Host-side SCSI Parameters,” then press [ENTER]. Choose “Max Number of Concurrent Host-LUN Connection,” then press [ENTER]. A list of available selections will appear. Move cursor bar to an item, then press [ENTER]. Choose **Yes** in the dialog box that follows to confirm your setting. The default is “4.”

Number of Tags Reserved for Each Host-LUN Connection

Each nexus has 32 (the default setting) tags reserved. When the host computer sends 8 I/O tags to the controller, and the controller is too busy to process them all, the host might start to send less than 8 tags during every certain period of time since then. This setting ensures that the controller will accept at least 32 tags per nexus. The controller will be able to accept more than that as long as the controller internal resources allow - if the controller does not have enough resources, at least 32 tags can be accepted per nexus.

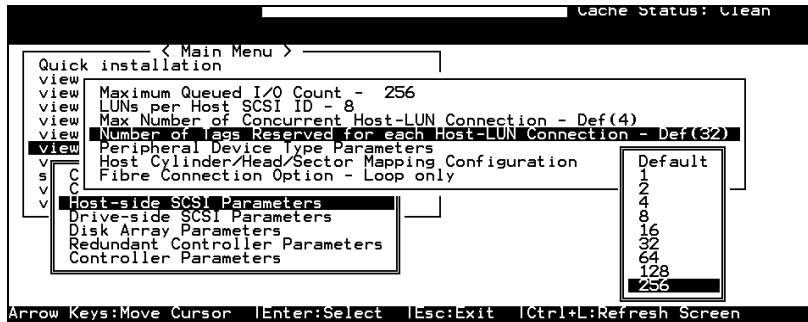

Choose “Host-side SCSI Parameters,” then press [ENTER]. Choose “Number of Tags Reserved for each Host-LUN Connection,” then press [ENTER]. A list of available selections will appear. Move the cursor bar to an item, then press [ENTER]. Choose **Yes** in the dialog box that follows to confirm the setting.

Maximum Queued I/O Count:

This function allows you to configure the maximum queued I/O count the controller can receive from the host computer.

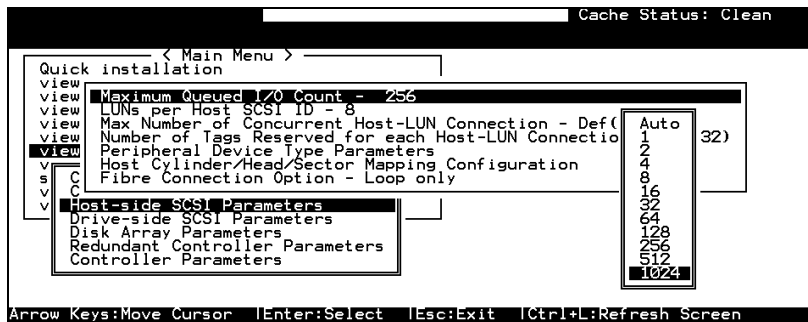

Choose “Host-side SCSI Parameters,” then press [ENTER]. Choose “Maximum Queued I/O Count,” then press [ENTER]. A list of available selections will appear. Move the cursor bar to an item, then press [ENTER]. Choose **Yes** in the dialog box that follows to confirm the setting.

The controller supports the following Host-side SCSI configurations:

“Maximum Queued I/O Count,” “LUNs per Host SCSI ID,” “Num of Host-LUN Connect,” “Tag per Host-LUN Connect,” “Peripheral Dev Type Parameters,” and “Cyl/Head/Sector Mapping Config.”

LUNs per Host SCSI ID

Wed Jul 17 05:55:39 2002 Cache Status: Clean

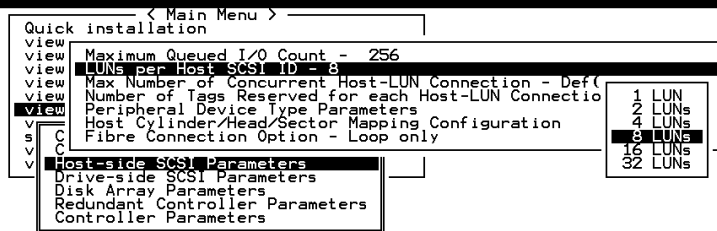

Arrow Keys:Move Cursor |Enter:Select |Esc:Exit |Ctrl+L:Refresh Screen

Choose "LUNs per Host SCSI ID," then press [ENTER]. A list of selections will appear. Move the cursor bar to an item, then press [ENTER]. Choose **Yes** in the dialog box that follows to confirm the setting.

LUN Applicability:

If no logical drive has been created and mapped to a host LUN, and the RAID controller is the only device connected to the host SCSI card, usually the operating system will not load the driver for the host adapter. If the driver is not loaded, the host computer will not be able to use the in-band utility to communicate with the RAID controller. This is often the case when users want to start configuring a RAID using management software from the host. It will be necessary to configure the "Peripheral Device Type" setting for the host to communicate with the controller. If the "LUN-0's only" is selected, only LUN-0 of the host ID will appear as a device with the user-defined peripheral device type. If "all undefined LUNs" is selected, each LUN in that host ID will appear as a device with the user-defined peripheral device type.

Different "LUN applicability" selections are available: "Device Type" selection, "Device Qualifier Support," "Support Removable media," "LUN-0's only," and "All undefined LUNs." Please refer to *Peripheral Device Type Parameters for Various Operating Systems* for details concerning various operating systems.

Peripheral Device Type:

For connection without a preset logical unit to a host, the in-band SCSI protocol can be used for the host to "see" the RAID controller. Please refer to the reference table below. You will need to make adjustments in the following submenu: Peripheral Device Type, Peripheral Device Qualifier, Device Support for Removable Media, and LUN Application.



In-band (SCSI or Fibre)

What is In-band?

External devices require communication with the host computer for device monitoring and administration. In addition to the regular RS-232, in-band SCSI can serve as an alternative means of management communications. In-band SCSI translates the original configuration commands into standard SCSI commands. These SCSI commands are then sent to and received by the controller over the existing host link, either SCSI or Fibre.

Peripheral Device Type Parameters for Various Operating Systems

A host cannot “see” a RAID controller **UNLESS** the following is configured:

1. (a) a logical unit has been created
 - (b) at least one logical unit is mapped to a host ID or LUN via the RS-232/front panel interface
2. (a) the "in-band SCSI" connection with the host is established.
 - (b) the RAID controller is configured to appear as a peripheral device on the channel bus connected to host

If users want to start configuring a RAID system from the host before any RAID configuration is made, the host will not be able to “see” the RAID controller. In order for a host to “see” the controller, it will be necessary to define the controller as a peripheral device.

Different host operating systems require different adjustments. See the tables below to find the proper settings for your host operating system. References to “Peripheral Device Qualifier” and “Device Support for Removable Media” are also included.

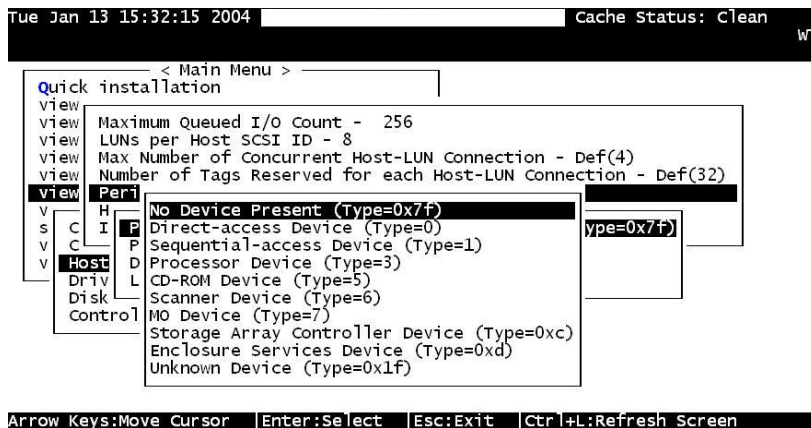

Table 9 - 1 Peripheral Device Type Parameters

Operating System	Peripheral Device Type	Peripheral Device Qualifier	Device Support for Removable Media	LUN Applicability
Windows NT® 4.0	0x1f	Connected	Disabled	All Undefined LUNs
NetWare® 4.x/Windows 2000	0x03	Connected	Disabled	All Undefined LUNs
SCO OpenServer 5.0x	0x7f	Connected	Either is okay	All Undefined LUNs
SCO UnixWare 2.1x, UnixWare 7	0x03	Connected	Either is okay	All Undefined LUNs
Solaris™ 2.5.x/2.6 (x86 and SPARC)	0x7f	Connected	Either is okay	All Undefined LUNs
Linux	0x03	Connected	Enabled	All Undefined LUNs

Table 9 - 2 Peripheral Device Type Settings

Device Type	Setting
No Device Present	0x7f
Direct-access Device	0
Sequential-access Device	1
Processor Type	3
CD-ROM Device	5
Scanner Device	6
MO Device	7
Storage Array Controller Device	0xC
Unknown Device	0x1f

Cylinder/Head/Sector Mapping:

Drive capacity is decided by the number of blocks. For some operating systems (Sun Solaris, etc.) the capacity of a drive is determined by the cylinder/head/sector count. For Sun Solaris, the cylinder cannot exceed 65535; choose "cylinder<65535," then the controller will automatically adjust the head/sector count for your OS to read the correct drive capacity. Please refer to the related documents provided with your operating system for more information.

Cylinder, Head, and Sector counts are selectable from the configuration menus shown below. To avoid any difficulties with a Sun Solaris configuration, the values listed below can be applied.

Table 9 - 3 Cylinder/Head/Sector Mapping under Sun Solaris

Capacity	Cylinder	Head	Sector
< 64 GB	variable	64	32
64 - 128 GB	variable	64	64
128 - 256 GB	variable	127	64
256 - 512 GB	variable	127	127
512 GB - 1 TB	variable	255	127
1TB	variable	255	255

Older Solaris versions do not support drive capacities larger than 1 terabyte.

Configuring Sector Ranges/Head Ranges/Cylinder Ranges:

Selecting Sector Ranges

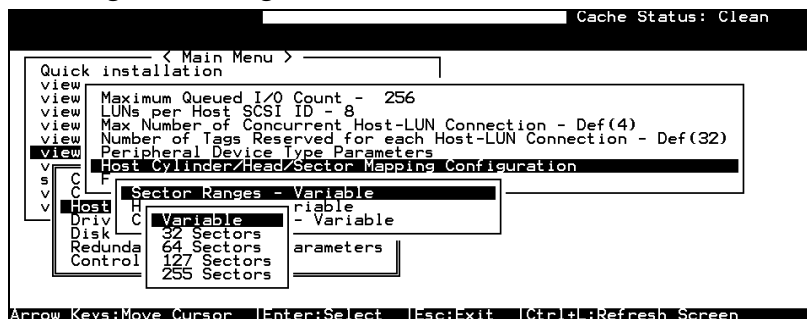

Selecting Head Ranges

```

    < Main Menu >
Quick installation
view
view Maximum Queued I/O Count - 256
view LUNs per Host SCSI ID - 8
view Max Number of Concurrent Host-LUN Connection - Def(4)
view Number of Tags Reserved for each Host-LUN Connection - Def(32)
view Peripheral Device Type Parameters
view Host Cylinder/Head/Sector Mapping Configuration
v
v C
v C
v C
v Host Sector Ranges - Variable
v Host Head Ranges - Variable
v Drive s - Variable
v Disk Variable
v Redunda 64 Heads Parameters
v Control 127 Heads
          255 Heads
  
```

Selecting Cylinder Ranges

```

    < Main Menu >
Quick installation
view
view Maximum Queued I/O Count - 256
view LUNs per Host SCSI ID - 8
view Max Number of Concurrent Host-LUN Connection - Def(4)
view Number of Tags Reserved for each Host-LUN Connection - Def(32)
view Peripheral Device Type Parameters
view Host Cylinder/Head/Sector Mapping Configuration
v
v C
v C
v C
v Host Sector Ranges - Variable
v Host Head Ranges - Variable
v Drive Cylinder Ranges - Variable
v Disk Variable
v Redunda < 1024 Cylinders
v Control < 32768 Cylinders
          < 65536 Cylinders
  
```

9.2 Drive-side Parameters:



Choose “Drive-side SCSI Parameters,” then press [ENTER]. The Drive-side SCSI parameters menu displays.

SCSI Motor Spin-Up

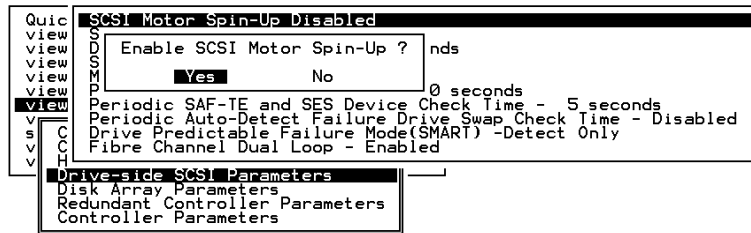

When a power supply is unable to provide sufficient current to start all of the hard drives at once, you may have the drives spin-up in sequence to solve the problem with insufficient power-up current.

By default, all hard drives will start spinning up when powered-on; however, these hard drives can be configured so that drives will not spin-up all at the same time. There are 3 methods for spinning-up the hard drive’s motor: “Spin-up at power-on,” “Spin-up serially at random sequence” or “Spin-up by SCSI command.” Please refer to the hard drive’s documentation for instructions on configuring the hard drive using the “Spin-up by SCSI Command.” The procedure for each brand/model of hard drive may vary.

Configure all hard drives (usually by switching jumpers on the hard disks). Choose “SCSI Motor Spin-Up,” then press [ENTER]. Choose **Yes** in the dialog box that follows to confirm the setting.

IMPORTANT!

- *If the drives are configured as “Delay Motor Spin-up” or “Motor Spin-up in Random Sequence,” some of these drives may not be ready when the controller accesses them when it is powered up. Increase the disk access delay time so that the controller will wait a longer time for the drives to be ready.*
-

Disk Access Delay Time

This feature sets the delay time before the controller tries to access the hard drives after power-on. Default is 15 seconds.

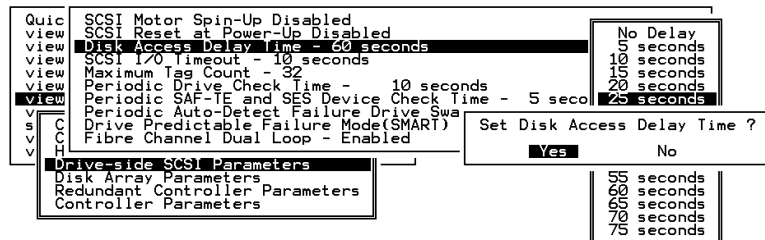

Choose “Disk Access Delay Time,” then press [ENTER]. A list of selections displays. Move the cursor bar to a selection, then press [ENTER]. Choose **Yes** in the dialog box that follows to confirm the setting.

Drive I/O Timeout

The “Drive I/O Timeout” is the time interval for the controller to wait for a drive to respond. If the controller attempts to read data from or write data to a drive but the drive does not respond within the Drive I/O Timeout value, the drive will be considered as a failed drive.

When the drive itself detects a media error while reading from the drive platter, it usually retries the previous reading or re-calibrates the head. When the drive encounters a bad block on the media, it reassigns the bad block onto a spare block. However, it takes time to perform the above actions. The time to perform these operations can vary between different brands and different models.

During channel bus arbitration, a device with higher priority can utilize the bus first. A device with lower priority will sometimes receive a SCSI I/O timeout when devices of higher priority keep utilizing the bus.

The default setting for “Drive I/O Timeout” is 7 seconds. It is highly recommended not to change this setting. Setting the timeout to a lower value will cause the controller to judge a drive as failed while a drive is still retrying, or while a drive is unable to arbitrate the SCSI bus. Setting the timeout to a greater value will cause the controller to keep waiting for a drive, and it may sometimes cause a host timeout.

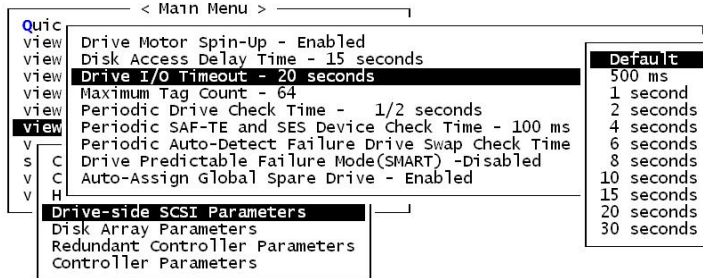

Choose “Drive I/O Timeout -Default (7 seconds),” then press [ENTER]. A list of selections will appear. Move the cursor bar to a selection, then press [ENTER]. Choose **Yes** in the dialog box that follows to confirm the setting.

Maximum Tag Count (Tag Command Queuing)

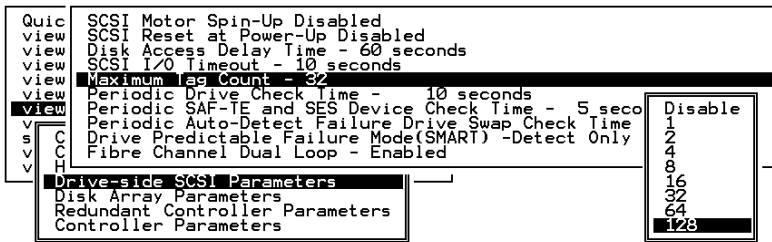

The controller supports tag command queuing with an adjustable maximum tag count from 1 to 128. The default setting is “Enabled” with a maximum tag count of 32. Choose “Maximum Tag Count”, then press [ENTER]. A list of available tag count numbers displays. Move the cursor bar to a number, then press [ENTER]. Choose **Yes** in the dialog box that follows to confirm the setting.

IMPORTANT!

- Every time you change this setting, you must reset the controller for the changes to take effect.
 - Disabling Tag Command Queuing will disable the hard drives’ built-in cache for Write-Back operation.
-

Enclosure Management

This chapter discusses the configuration options related to enclosure monitoring. Each function is given a brief explanation as well as a configuration sample. Terminal screens will be used in the configuration samples. Some of the operations require basic knowledge of RAID technology and are only recommended for an experienced user.

10.1 Enclosure Monitoring

10.1.1 Enclosure Devices

SAF-TE and SES Enclosure Monitoring

(Periodic SAF-TE and SES Device Check Time)

```
Quic  SCSI Motor Spin-Up Disabled
view  SCSI Reset at Power-Up Disabled
view  Disk Access Delay Time - 60 seconds
view  SCSI I/O Timeout - 10 seconds
view  Maximum Tag Count - 32
view  Periodic Drive Check Time - 10 seconds
view  Periodic SAF-TE and SES Device Check Time - 5 secc
view  Periodic Auto-Detect Failure Drive Swap Check time 1 second
s     Drive Predictable Failure Mode(SMART) -Detect Only 2 seconds
C     Fibre Channel Dual Loop - Enabled 5 seconds
v     10 seconds
H     20 seconds
      30 seconds
      60 seconds
      Disabled
      50 ms
      100 ms
      200 ms
      500 ms
Drive-side SCSI Parameters
Disk Array Parameters
Redundant Controller Parameters
Controller Parameters
```

If there are remote components in your RAID enclosure being controlled via SAF-TE/S.E.S. devices, use this function to select how often the controller will check the status of these devices. Choose "Periodic SAF-TE and SES Device Check Time"; then press [ENTER]. Move the cursor to the desired interval, then press [ENTER]. Choose Yes in the dialog box that follows to confirm the setting.

Some Infortrend EonStor drive enclosures (JBODs) come with the SES monitoring service and have a preset value for the device check time. The firmware default is 30 seconds.

Enclosure Devices Status: View Peripheral Device Status

Select "View and edit Peripheral Devices" on the Main Menu and press [ENTER]. Choose "View Peripheral Device Status," then press [ENTER] again. The device list displays.

Below is a list of peripheral devices (enclosure modules) supported by enclosure monitoring. Monitoring of device status depends on enclosure implementation and is accessed through different interfaces, e.g., SAF-TE, S.E.S., or I²C serial bus.

1. Device type
2. Enclosure descriptor
3. Power supply
4. Cooling element
5. Temperature Sensors
6. Audible alarm
7. Enclosure services controller electronics

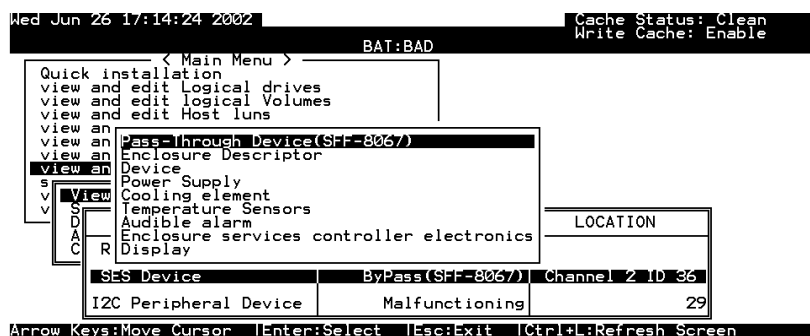

Select the device interface and then press [ENTER] on a connected module to examine its operating status as shown below.

```

Wed Jun 26 17:16:24 2002                                     Cache Status: Clean
                                                            Write Cache: Enable
                                BAT:BAD
                                < Main Menu >
                                Quick installation
                                Status :OK
                                Temperature :34 (C)
                                High Critical Threshold:63 (C)
                                High Warning Threshold :53 (C)
                                Low Warning Threshold :40 (C)
                                Low Critical Threshold :30 (C)
                                v View Cooling element
                                v S Temperature Sensors
                                A Overall Status controller electronics LOCATION
                                C En Element 1
                                R Di
                                SES Device ByPass(SFF-8067) Channel 2 ID 36
                                I2C Peripheral Device Malfunctioning 29
                                Arrow Keys:Move Cursor |Enter:Select |Esc:Exit |Ctrl+L:Refresh Screen

```

Event Triggered Operations

```

Fri Jan 16 10:51:39 2004                                     Cache Status: Clean
                                < Main Menu >
                                Quick installation
                                view and edit Logical drives
                                view and edit logical Volumes
                                view and edit Host luns
                                view and edit scsi Drives
                                view an Event Trigger Operations
                                view an Controller Failure - Disabled
                                view an BBU Low or Failed - Disabled
                                s UPS AC Power Loss - Enabled
                                v View Power Supply Failed - Disabled
                                v Set FAN Failure - Disabled
                                A Temperature exceeds threshold - Shutdown Period: 2 min
                                C R Event Trigger Operations
                                Arrow Keys:Move Cursor |Enter:Select |Esc:Exit |Ctrl+L:Refresh Screen

```

Select “View and Edit Peripheral Devices” on the Main Menu and press [ENTER]. Choose “Set Peripheral Device Entry”, press [ENTER], then select “Event Trigger Operations” by pressing [ENTER]. The event trigger menu displays.

The Operations

To reduce the chance of data loss, the controller/subsystem automatically commences the following actions to prevent loss of data:

- 1). Switches its caching mode from write-back to write-through,
- 2). Flushes all cached data

The Trigger

The mode switching and cache flush operations can be triggered by the detection of the following conditions:

1. Controller failure (in dual-redundant controller configurations)

2. BBU low or failed
3. UPS AC power loss
4. Power supply failure
5. Fan failure
6. Temperature exceeds threshold

When enabled, each of the above conditions forces the controller/subsystem to adopt the write-through caching mode. When the fault condition is corrected, the controller/subsystem automatically restores the previous caching mode.



Note the temperature thresholds refer to those set for “RAID controller board temperature” and the sensors within subsystem enclosure. In terms of the controller temperature, board 1 refers to the main circuit board and board 2 refers to the second-level I/O board or daughter card.

If a battery is not used, the “BBU Low or Failed “ option should be disabled.

You can configure a shutdown period to delay the time when the controller/subsystem commences an automatic shutdown. During this time, system administrators should have been notified of the condition and begun restoring proper cooling of the subsystem.

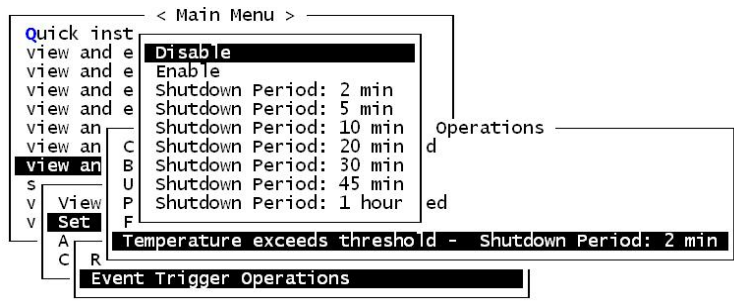

Dynamic Caching Mode Switch

Controller Auto-Shutdown - Event Triggered Operations

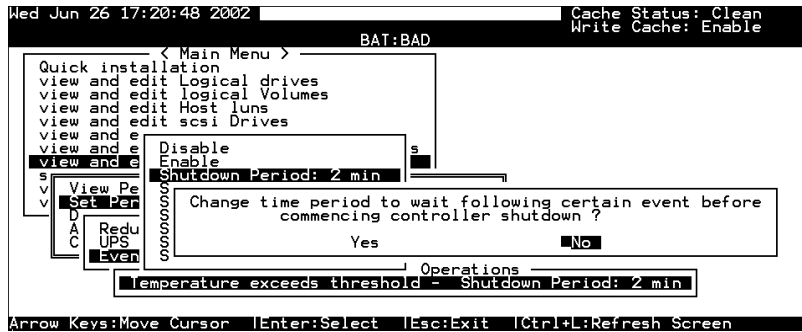

Select “View and Edit Peripheral Devices” on the Main Menu and press [ENTER]. Choose “Set Peripheral Device Entry” and “Event Trigger Option” by pressing [ENTER]. The auto-shutdown option displays.

Select a configurable time span between the detection of exceeded temperature and the controller’s commencing an automatic shutdown. Extended operation under critical conditions like elevated temperature greatly reduces system efficiency and may cause component failure.

10.1.2 Controller Self-monitoring

Open your PC Terminal Emulation screen. Enter the Main Menu and select “View and Edit Peripheral Devices.” Use the arrow keys to scroll down and select “Controller Peripheral Device Configuration,” “View Peripheral Device Status,” and then press [ENTER].

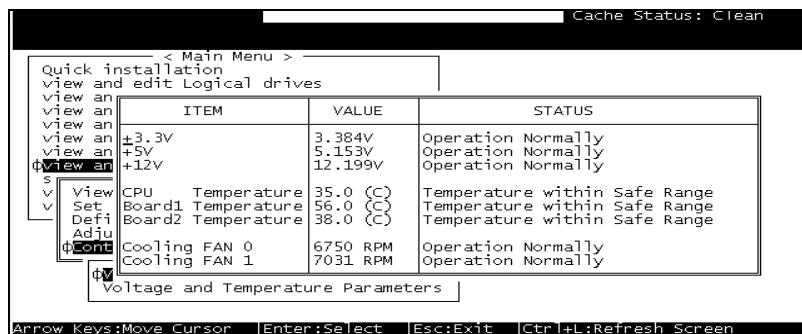

The controller operation status displays. Note the fan status here refers to the 3cm fans in the front panel of RAID controllers that come standard in 5.25" canister. The enclosure fan status is shown in the *Enclosure Devices Status: View Peripheral Device Status*.

Changing Monitoring Thresholds

Open your PC Terminal Emulation utility. Enter the Main Menu and select "View and Edit Peripheral Devices." Use the arrow keys to scroll down and select "Controller Peripheral Device Configuration," "Voltage and Temperature Parameters," and confirm by pressing [ENTER].

Note that it is not recommended to change the threshold values unless you need to coordinate the RAID controller's values with that of your RAID enclosure. If a value exceeding the safety range is entered, an error message will prompt and the new parameter will be ignored.

For example, if the controller operates in a system enclosure where the upper limit on ambient temperature is relatively high or low, adjusting the default thresholds can coordinate the controller status monitoring with that of the system enclosure.



Scroll down and select an item to configure.

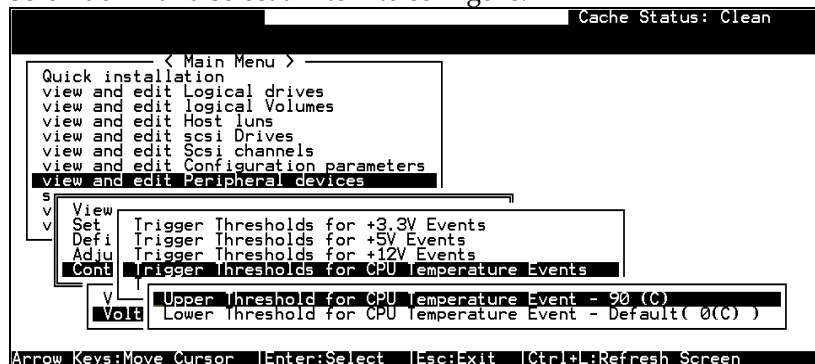

Select an item, such as “Trigger Thresholds for CPU Temperature Events.” Press [ENTER] and a list of selections will appear. You can change the upper or lower threshold values. Press [ENTER] to confirm.

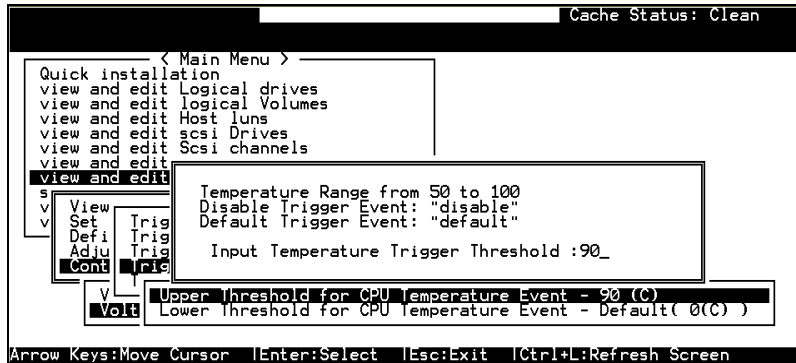

A configuration window will prompt. Enter any value within the safety range. Values exceeding the safety range will be rejected by controller firmware.

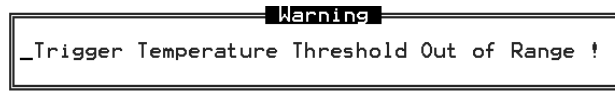

Follow the same method to modify other threshold parameters.

10.2 UPS Support

UPS status monitoring is available from firmware release 3.34 onward. This feature enables the RAID subsystem to observe and respond to the status of the UPS (battery charge or AC power) by dynamically switching the write policy.

Requirements for UPS Status Monitoring:

1. Connect the UPS device to the controller/subsystem’s COM2 serial port.
2. Set the same Baud Rate to the system COM2 and the UPS serial port. Please refer to *Chapter 3*, RS-232C Serial Port Settings.
3. Set the UPS option in the Event Triggered Operations to “Enabled.”

Condition Reports and Reactions:

1. When mains power is lost or when the UPS charge is low, an event is issued; the subsystem commences an auto cache-flush and is forced to adopt the Write-Through mode.
2. When the serial port connection is lost or when the UPS is removed, an event is issued to notify the system manager that the external UPS is absent.
3. When the UPS battery charge or mains power is restored to a safe functioning level, the subsystem automatically restores the original write policy.

Data Integrity

This chapter discusses various firmware mechanisms that help to secure the integrity of array data. Four main topics are included:

- **Maintenance processes** that can be manually or automatically performed onto configured arrays to minimize the chance of data inconsistency due to drive media errors.
- **Data path re-routing capability** to direct data flow through an alternate path in the situation when one of the cabling connections fails.
- **Preventive schemes** to suspend caching activities that are susceptible to hardware faults until the faults are corrected.
- **Drive Fault detection and Rebuild settings.**

No system is completely safe from the threat of hardware faults. For example, although the chance of occurrence is considerably low, the occurrences of bad blocks on two hard drives can fail a whole data set. When properly configured, the functions below help to minimize the chance of data loss:

1. Event Triggered Operations
2. Failed Drive Detection
3. Scheduled Maintenance
4. Regenerate Logical Drive Parity
5. Rebuild Priority
6. Verification on Writes

NOTE:

Some of the configuration options may be implemented through firmware append files and may not be available to all sub-revisions of firmware.

Event Triggered Operations

```

Fri Jan 16 10:51:39 2004 Cache Status: Clean

      < Main Menu >
Quick installation
view and edit Logical drives
view and edit Logical Volumes
view and edit Host luns
view and edit scsi Drives
view an
view an
View an
S
V
V
A
C
R
Event Trigger Operations
Controller Failure - Disabled
BBU Low or Failed - Disabled
UPS AC Power Loss - Enabled
Power Supply Failed - Disabled
FAN Failure - Disabled
Temperature exceeds threshold - Shutdown Period: 2 min
Event Trigger Operations

Arrow Keys:Move Cursor |Enter:Select |Esc:Exit |Ctrl+L:Refresh Screen

```

Select “View and Edit Peripheral Devices” on the Main Menu and press [ENTER]. Choose “Set Peripheral Device Entry”, press [ENTER], then select “Event Trigger Operations” by pressing [ENTER]. The event trigger menu displays.

The Operations

To reduce the chance of data loss, the controller/subsystem automatically commences the following actions to prevent loss of data:

- 1). Switches its caching mode from write-back to write-through
- 2). Flushes all cached data

The Trigger

The mode switching and cache flush operations can be triggered by the detection of the following conditions:

1. **Controller failure:**

If a controller fails in a dual-redundant controller configuration, the surviving controller no longer has the protection of cached data by storing the replica of unfinished writes to its partner.

2. **BBU low or failed:**

If battery fails or is under-charge, the unfinished writes cannot be supported if power outage occurs.

3. *UPS AC power loss:*

Even with the buffer provided by the UPS, if the mains power fails, cached data should be immediately distributed to hard drives.

4. *Power supply failure*

5. *Fan failure*

6. *Temperature exceeds threshold*

If critical conditions occur, such as the enclosure component failure, chance of system downtime will increase and it is best to temporarily disable write-back caching.

When enabled, each of the above conditions forces the controller/subsystem to adopt the write-through caching mode. When the fault condition is corrected, the controller/subsystem automatically restores the previous caching mode.

Alert

Force Controller Write-Through on Trigger Cause

Note that the temperature thresholds refer to those set for both sensors on the RAID controller boards and those placed within the subsystem enclosure. In terms of the controller temperature, board 1 refers to the main circuit board and board 2 refers to the second-level I/O board or the daughter card. If any of the threshold values set for any sensor is exceeded, the trigger automatically applies.

NOTE:

If a battery is not installed in your RAID subsystem, the "BBU Low or Failed" option should be disabled.

Auto Shutdown: Elevated Temperature

System components can be damaged if operated under elevated temperature. You can configure the time periods between the detection of exceeded thresholds and the controller's commencing an automatic shutdown.

The shutdown does not electrically disconnect the subsystem. When shutdown is commenced, the subsystem stops responding to I/O requests and flushes all cached writes in its memory. During that time, system administrators should have been notified of the condition and have begun restoring proper cooling of the subsystem.

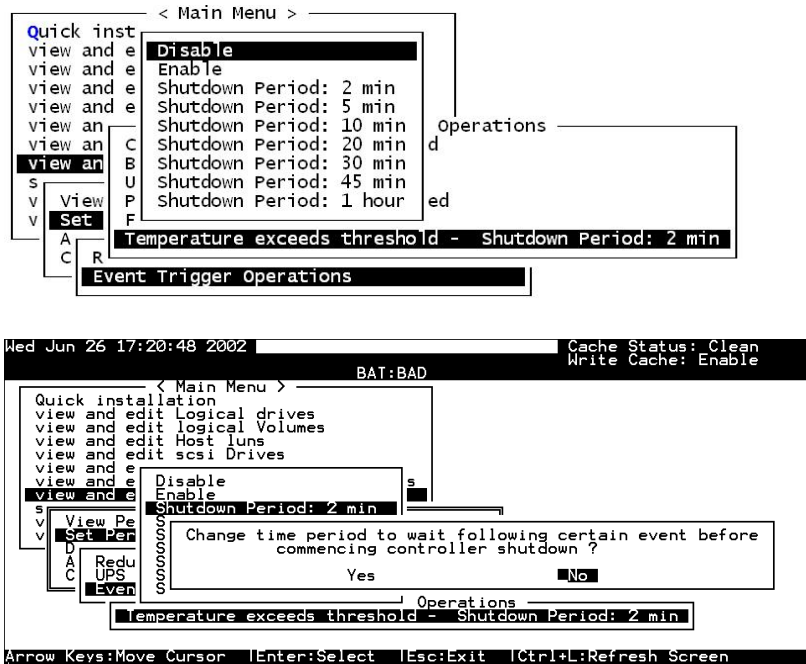

Select “View and Edit Peripheral Devices” on the Main Menu and press [ENTER]. Choose “Set Peripheral Device Entry” and “Event Trigger Option” by pressing [ENTER]. The auto-shutdown options display.

Select a configurable time span between the detection of exceeded temperature and the controller’s commencing an automatic shutdown. Extended operation under critical conditions like elevated temperature greatly reduces system efficiency and will eventually cause component failure.

11.2 Maintenance

11.2.1 Failed Drive Detection

Detection of Drive Hot Swap Followed by Auto Rebuild

(Periodic Auto-Detect Failure Drive Swap Check Time)

```
Quick view SCSI Motor Spin-Up Disabled
view SCSI Reset at Power-Up Disabled
view Disk Access Delay Time - 60 seconds
view SCSI I/O Timeout - 10 seconds
view Maximum Tag Count - 32
view Periodic Drive Check Time - 10 seconds
view Periodic SAF-TE and SES Device Check Time - 5 seconds
view Periodic Auto-Detect Failure Drive Swap Check Time - Disabled
view Drive Predictable Failure Mode(SMART) -Detect Only
view Fibre Channel Dual Loop - Enabled
view Drive-side SCSI Parameters
view Disk Array Parameters
view Redundant Controller Parameters
view Controller Parameters
```

Disabled
5 seconds
10 seconds
15 seconds
30 seconds
60 seconds

Choose “Periodic Auto-Detect Failure Drive Swap Check Time”; then press [ENTER]. Move the cursor to the desired interval; then press [ENTER]. Choose **Yes** in the dialog box that follows to confirm the setting.

The controller scans drive buses at this interval to check if a failed drive has been replaced. If a failed drive is replaced, the controller will proceed with the rebuild process.

Periodic Drive Check Time

The “Periodic Drive Check Time” is the time interval for the controller to check all disk drives that were on the SCSI bus at controller startup (a list of all the drives that were detected can be seen under “View and Edit SCSI Drives”).

The default value is “Disabled.” “Disabled” means that if a drive is removed from the bus, the controller will not be able to know – so long as no host accesses that drive. Changing the check time to any other value allows the controller to check – at the selected time interval – all of the drives that are listed under “View and Edit SCSI Drives.” If any drive is then removed, the controller will be able to know – even if no host accesses that drive.

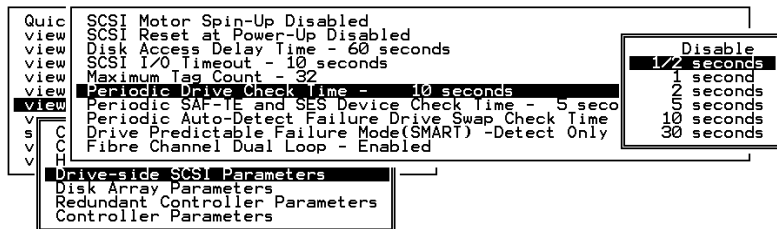

Idle Drive Failure Detection

Periodic Auto-Detect Failure Drive Swap Check Time

The “Drive-Swap Check Time” is the interval at which the controller checks to see if a failed drive has been swapped. When a logical drive’s member drive fails, the controller will detect the failed drive (at the selected time interval). Once the failed drive has been swapped with a drive that has the adequate capacity to rebuild the logical drive, the rebuild will begin automatically.

The default setting is “Disabled,” meaning that the controller will not Auto-Detect the swap of a failed drive. To enable this feature, select a time interval.



Choose “Periodic Drive Check Time,” then press [ENTER]. Move the cursor to the desired interval, then press [ENTER]. Choose Yes in the dialog box that follows to confirm the setting.

IMPORTANT!

- The "Periodic Drive Check Time" is enabled by choosing a time value. The RAID controller will poll all connected drives through the controller's drive channels at the assigned interval. Drive removal will be detected even if a host does not attempt to access data on that specific drive.
 - If the "Periodic Drive Check Time" is set to "Disabled" (the default setting is "Disabled"), the controller will not be able to detect any drive removal that occurs after the controller has been powered on. The controller will only be able to detect drive removal when a host attempts to access data on that drive.
-

Auto-Assign Global Spare Drive

```
      < Main Menu >
Quick installation
view and edit Logical drives
view and edit logical Volumes
view and edit Host luns
view and edit scsi Drives
view
view SCSI Motor Spin-Up - Disabled
view SCSI Reset at Power-Up - Enabled
view Disk Access Delay Time - 15 seconds
view SCSI I/O Timeout - 10 seconds
view Maximum Tag Count - 32
view Periodic Drive Check Time - 1/2 seconds
view Periodic SAF-TE and SES Device Check Time - 200 ms
view Drive Predictable Failure Mode(SMART) -Disabled
view Fibre Channel Dual Loop - Enabled
view Auto-Assign Global Spare Drive - Disabled
```

The "Auto-Assign" function automatically assigns any "new" drives that are not included in logical configurations as Global Spares.

The Fault Scenario:

Spare drives accelerate rebuild of a logical drive. In the example as described below, multiple faults can occur at the same time making the array exposed to the risk of data loss:

- There is only one Global Spare in a RAID subsystem.
- That Global Spare has been used to rebuild a logical drive.
- The failed drive is swapped out and replaced by a new one.
- Chances are system administrators forgot to configure the replacement drive as a spare.
- A member of another logical drive fails.
- The subsystem has no spare left. Performance decreases for a considerable portion of system resources has to be conducted to generate data from the remaining members of

the logical drive. If another member fails in the logical drive, data is lost.

The chance of failing two drives increases when a failed drive in the array cannot be replaced immediately for the lack of spare drives.

The Function:

If a drive has a capacity smaller or apparently larger than the members of configured arrays, the controller may avoid using it as a global spare.

Enable the function and reset the controller for the configuration to take effect.

11.2.2 Scheduled Maintenance

Task Scheduler

The Task Scheduler functionality allows Media Scans to be scheduled beginning at a specified start time and repeating at regular intervals defined by a configurable interval period. Each such schedule can be defined to operate on individual drives, all drives of a certain class, all member drives of a specified logical drive, or all member drives of all logical drives. UIs supported are RS232C terminal menus and RAIDWatch GUI manager.

Fri May 7 13:44:51 2004 Cache Status: Clean

BAT: NONE

LG	ID	LV	RAID	Size(MB)	Status	1	2	3	O	C	#LN	#SB	#FL	NAME
0	ECC3E8E	NA	RAID5	1673784	SHUTDOWN				7	B	8	1	0	
				112	GOOD				7	B	2	1	0	
				000	GOOD				7	B	2	1	0	
				000	GOOD				7	B	3	1	0	
7			NONE											

View drives
Delete logical drive
Partition logical drive
logical drive Name
Expand logical drive
add driveS
reGenerate parity
cOpy and replace drive
Media scan
write policy

Arrow Keys:Move Cursor | Enter:Select | Esc:Exit | Ctrl+L:Refresh Screen

The scheduler is accessed through the “View and Edit Logical Drives” menu by selecting a configured array to display the list of array-related functions. Select “Media Scan” by pressing [ENTER].

Media Scan Priority - Normal
Iteration Count - Single Time
Task Scheduler

Select "Task Scheduler" by pressing [ENTER].

Creating a New Schedule

LG	ID	LV	RAID	Size(MB)	Status	1	2	3	0	C	#LN	#SB	#FL		
0	ECC3E8E	NA	RAID5	1673784					7	B	8	1	0		
	Media Scan Priority - Normal										7	B	2	1	0
	Iteration Count - Single Time														
	Task Scheduler										7	B	2	1	0
3	No Media Scan Task Schedule - Add a New Task Schedule ?														
4	Yes						No								

If there is no preset schedule, a confirm box as shown above will prompt.

Adding or Deleting a Schedule

	Media Scan Priority - Normal										7	B	2	1	0
	Iteration Count - Single Time														
	Task Scheduler										7	B	2	1	0
3	Idx	Start Time and Date			Period		Exec on Init								
4	0	Fri May 7 14:09:00 2004			10 hours		Priority								
5	View Schedule Information														
6	Add New Schedule														
	Delete Schedule														

Press [ENTER] on an existing schedule to display the configuration options. You may choose to check information of a task schedule, to create a new schedule, or to remove a configured schedule.

Task Scheduler Options

To configure a task schedule, you have the option to do any of the following:

Set the following values/intervals:

Execute on Controller Initialization

Media Scan Priority - Normal	
Iteration Count - Single Time	
Task Scheduler	
Execute on Controller Initialization - YES	
Start time and date - Not Set	
Execution Period - Not Set	
Media Scan Mode - Concurrence	
Media Scan Priority - Normal	
Select logical drives	

This option determines whether Media Scan is automatically conducted whenever the RAID system is reset or powered on.

Start Time and Date

Execute on Controller Initialization - YES	1	0
Start time and date - Fri May 7 14:09:00 2004		
E		
M		
M	Set Start Time and Date [MMDDhhmmYYYY] : █	
S		

Enter time and date in its numeric representatives in the following order: month, day, hour, minute, and the year.

Execution Period

Execute on Controller Initialization - YES	Schedule Period	- YES
Start time and date - Fri May 7 14:09:00 2004	Execution Once	
Execution Period -	1 secs	
Media Scan Mode - C	2 secs	
Media Scan Priority	3 secs	
Select logical drive	⋮	
	10 days	
	11 days	
	12 days	
	13 days	
	2 weeks	
	3 weeks	

The scheduler memorizes the date and the time the actions are to be executed. Select one of the following:

- If the action is intended to be executed for one time only, select "Execution Once."
- In the case of a periodic action, the action is executed at the specified "start time," and then re-enacted at the time interval indicated in the execution period so as to be executed again later. The selectable interval ranges from one second to several weeks.

Media Scan Mode

Execute on Controller Initialization - YES	
Start time and date - Fri May 7 14:09:00 2004	
Execution Period - Not Set	
Media Scan Mode - Concurrency	
M	
S	Set Execution Mode to Sequence ?
	<input checked="" type="radio"/> Yes <input type="radio"/> No

If the maintenance schedule includes more than one logical drive, the scan can be performed simultaneously or separately in a sequential order.

Media Scan Priority

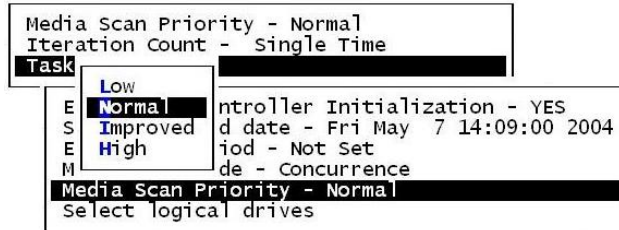

The scan priority determines how much of the system's resources will be consumed to perform the scheduled task. Select "Low" for better array performance and longer time to complete the media scan. Higher priority allows higher scan performance at the cost of reduced array performance.

Select Logical Drives

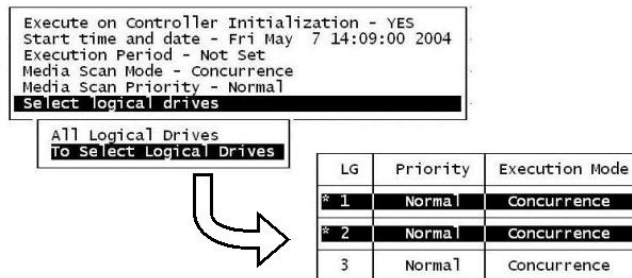

Press [ENTER] on "Select Logical Drives" to bring out a sub-menu. From there you may include all configured arrays or press [ENTER] on "To Select Logical Drives" to select one or more specific logical drive(s).

Logical drives can be tagged for inclusion by positioning the cursor bar on the logical drive and then pressing [ENTER]. An asterisk (*) mark will appear on the selected physical drive(s). To deselect the drive, press [ENTER] again on the selected drive. The "*" mark will disappear. Use the same method to select more logical drives if required.

When selection is done, press [ESC] to continue.

Confirming the Creation of a Task Schedule

LG	ID	LV	RAID	Size(MB)	Status	1	2	3	0	C	#LN	#SB	#
0	ECC3E8E	NA	RAID5	1673784	SHUTDOWN				7	B	8	1	
	Media Scan Priority - Normal												
	Iteration Count - Single Time												
	Task Scheduler												
3	Start Time and Date : Fri May 7 14:09:00 2004												1
4	Schedule Period : 10 hours												
5	Execution Mode : Sequence												
6	Priority : Low												
7	Logical Drive Count : 1												
6	Create Task Schedule ?												
7	<input checked="" type="radio"/> Yes <input type="radio"/> No												

When finished with setting the scheduler options, press [ESC] to display a confirm box.

Verify all information in the box before choosing “Yes” to confirm and to complete the configuration process.

11.2.3 Regenerating Logical Drive Parity

LG	ID	LV	RAID	Size(MB)	Status	1	2	3	0	C	#LN	#SB	#FL	NAME
P0	4295529B	NA	RAID5	476000	GOOD				4	B	3	0	0	
	Execute Regenerate Logical Drive Parity													
	Overwrite Inconsistent Parity - Enabled													
	Generate Check Parity Error Event - Enabled													
3			NONE											
4			NONE											
5			NONE											
6			NONE											
7			NONE											

Parity regeneration is a function manually performed onto RAID-1/3/5 arrays to determine whether inconsistency has occurred with data parity.

You may perform the parity check directly without changing the two options below, or set preferred options and then press [ENTER] on “Execute Regenerate Logical Drive Parity” to begin the operation.

Overwrite Inconsistent Parity

Default is “enabled.”

If an array’s data parity is seriously damaged, restoring parity data by regenerating and overwriting the original data may cause data

loss. Disable this option if you suspect parity data has been seriously corrupted.

Generate Check Parity Error Event

Default is “enabled.”

When enabled, parity inconsistency will be reported as system events.

IMPORTANT!

- *If a regenerating process is stopped by a drive failure, the process cannot be restarted until the logical drive is successfully rebuilt by having its failed member replaced.*
-

11.2.4 Disk Array Parameters

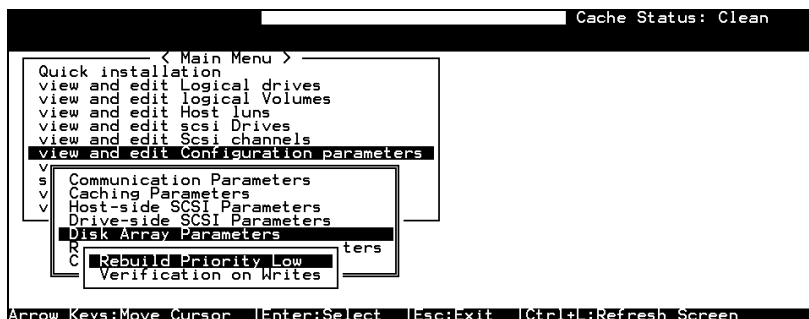

Select “View and Edit Configuration Parameters” on the Main Menu and press [ENTER]. Choose “Disk Array Parameters,” then press [ENTER] again. The Disk Array Parameters menu will appear.

Rebuild Priority

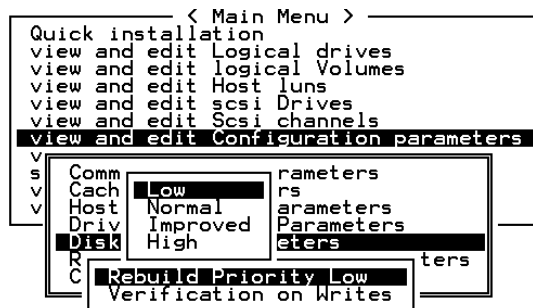

Choose “Rebuild Priority,” then press [ENTER]. A list of the priority selections (Low, Normal, Improved, or High) displays. Move the cursor bar to a selection, then press [ENTER].

Verification on Writes

Errors may occur when a hard drive writes data. To avoid the write error, the controller can force hard drives to verify written data. There are three selectable methods:

- Verification on LD Initialization Writes
Performs Verify-after-Write when initializing a logical drive
- Verification on LD Rebuild Writes
Performs Verify-after-Write during the rebuild process
- Verification on LD Normal Drive Writes
Performs Verify-after-Write during normal I/Os

Each method can be enabled or disabled individually. Hard drives will perform Verify-after-Write according to the selected method.

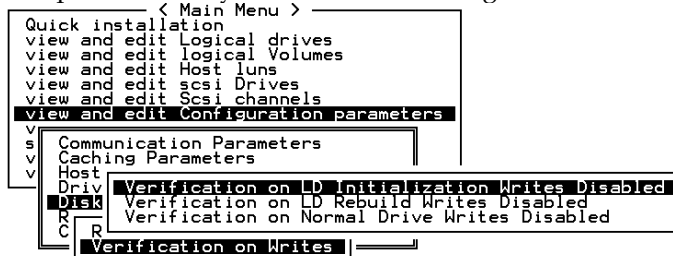

Move the cursor bar to the desired item, then press [ENTER].

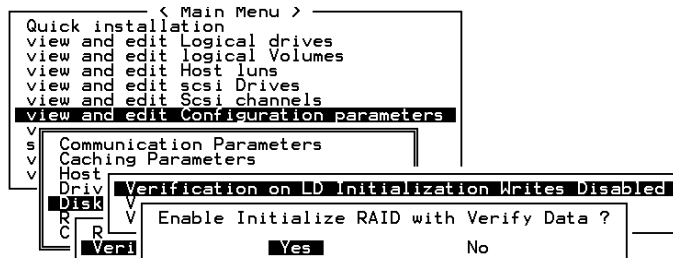

Choose **Yes** in the confirm box to enable or disable the function. Follow the same procedure to enable or disable each method.

IMPORTANT!

- The “verification on Normal Drive Writes” method will affect the “write” performance of your RAID system.
-

If the maintenance schedule includes more than one logical drive, the scan can be performed simultaneously or separately in a sequential order.

Media Scan Priority

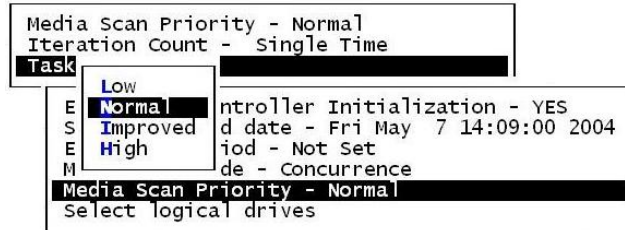

The scan priority determines how much of the system's resources will be consumed to perform the scheduled task. Select "Low" for better array performance and longer time to complete the media scan. Higher priority allows higher scan performance at the cost of reduced array performance.

Select Logical Drives

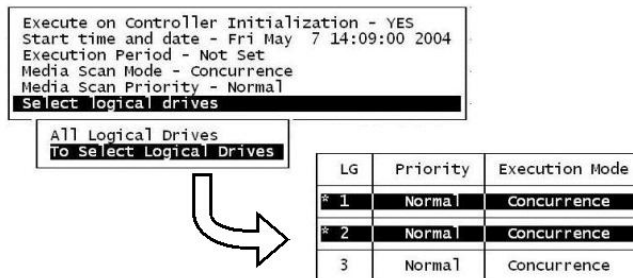

Press [ENTER] on "Select Logical Drives" to bring out a sub-menu. From there you may include all configured arrays or press [ENTER] on "To Select Logical Drives" to select one or more specific logical drive(s).

Logical drives can be tagged for inclusion by positioning the cursor bar on the logical drive and then pressing [ENTER]. An asterisk (*) mark will appear on the selected physical drive(s). To deselect the drive, press [ENTER] again on the selected drive. The "*" mark will disappear. Use the same method to select more logical drives if required.

When selection is done, press [ESC] to continue.

Confirming the Creation of a Task Schedule

LG	ID	LV	RAID	Size(MB)	Status	1	2	3	0	C	#LN	#SB	#
0	ECC3E8E	NA	RAID5	1673784	SHUTDOWN					7	B	8	1
Media Scan Priority - Normal										7	B	2	1
Iteration Count - Single Time										7	B	2	1
Task Scheduler													
3	Start Time and Date : Fri May 7 14:09:00 2004											1	
4	Schedule Period : 10 hours												
5	Execution Mode : Sequence												
6	Priority : Low												
7	Logical Drive Count : 1												
6	Create Task Schedule ?												
7	<input checked="" type="radio"/> Yes											<input type="radio"/> No	

When finished with setting the scheduler options, press [ESC] to display a confirm box.

Verify all information in the box before choosing “Yes” to confirm and to complete the configuration process.

11.2.3 Regenerating Logical Drive Parity

LG	ID	LV	RAID	Size(MB)	Status	1	2	3	0	C	#LN	#SB	#FL	NAME
P0	4295529B	NA	RAID5	476000	GOOD					4	B	3	0	0
Execute Regenerate Logical Drive Parity														
Overwrite Inconsistent Parity - Enabled														
Generate Check Parity Error Event - Enabled														
3			NONE											
4			NONE											
5			NONE											
6			NONE											
7			NONE											

Parity regeneration is a function manually performed onto RAID-1/3/5 arrays to determine whether inconsistency has occurred with data parity.

You may perform the parity check directly without changing the two options below, or set preferred options and then press [ENTER] on “Execute Regenerate Logical Drive Parity” to begin the operation.

Overwrite Inconsistent Parity

Default is “enabled.”

If an array’s data parity is seriously damaged, restoring parity data by regenerating and overwriting the original data may cause data

loss. Disable this option if you suspect parity data has been seriously corrupted.

Generate Check Parity Error Event

Default is "enabled."

When enabled, parity inconsistency will be reported as system events.

IMPORTANT!

- *If a regenerating process is stopped by a drive failure, the process cannot be restarted until the logical drive is successfully rebuilt by having its failed member replaced.*
-

11.2.4 Disk Array Parameters

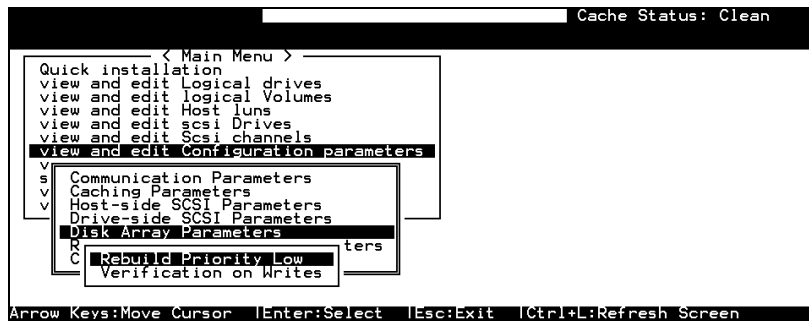

Select “View and Edit Configuration Parameters” on the Main Menu and press [ENTER]. Choose “Disk Array Parameters,” then press [ENTER] again. The Disk Array Parameters menu will appear.

Rebuild Priority

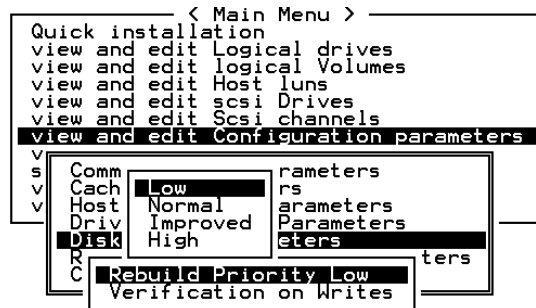

Choose “Rebuild Priority,” then press [ENTER]. A list of the priority selections (Low, Normal, Improved, or High) displays. Move the cursor bar to a selection, then press [ENTER].

Verification on Writes

Errors may occur when a hard drive writes data. To avoid the write error, the controller can force hard drives to verify written data. There are three selectable methods:

- Verification on LD Initialization Writes
Performs Verify-after-Write when initializing a logical drive
- Verification on LD Rebuild Writes
Performs Verify-after-Write during the rebuild process
- Verification on LD Normal Drive Writes
Performs Verify-after-Write during normal I/Os

Each method can be enabled or disabled individually. Hard drives will perform Verify-after-Write according to the selected method.

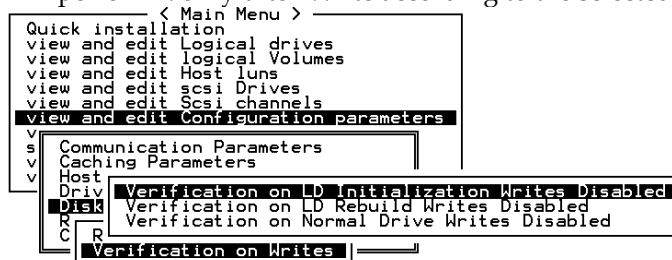

Move the cursor bar to the desired item, then press [ENTER].

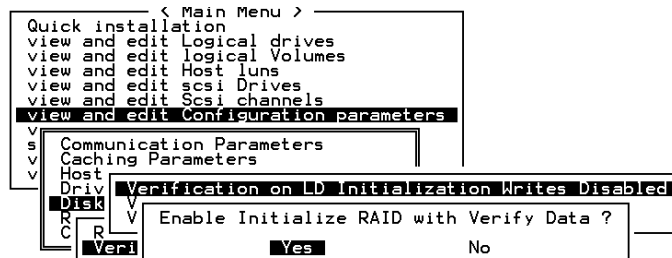

Choose **Yes** in the confirm box to enable or disable the function. Follow the same procedure to enable or disable each method.

IMPORTANT!

- The "verification on Normal Drive Writes" method will affect the "write" performance of your RAID system.
-

This chapter is written for system integrators using Infortrend's board-only controllers. The EonStor dual-redundant RAID subsystems come ready with related configurations. No user's configuration is necessary to bring up the controller pair.

12.1 Operation Theory

Sample topologies using redundant controllers can be found in the *Installation and Hardware Reference Guide* that came with your controller or subsystem. The proceeding discussions will focus on the theories behind and the configuration procedure for readying a redundant controller system.

Today's I/O interfaces pose increasing demands on signal quality. We assume that reliable inter-connections have already been made by combining controllers' channels either through a common backplane or cabling connection. Depending on the enclosure design, signal paths for communications may have been strung between controllers over a common backplane. Your controllers or subsystems, such as Infortrend's EonStor series, may come with preset IDs and channel mode settings, and require no further configuration.

Users who are familiar with the practice of redundant controller configuration, please move ahead to *Section 12.3 Configuration*.

This chapter includes the following topics:

Operation Theory

- 12.1.1 Considerations Related to Physical Connection
- 12.1.2 Grouping Hard Drives and LUN Mapping
- 12.1.3 Fault Tolerance

Preparing Controllers

- 12.2.1 Requirements

- 12.2.3 Configurable Parameters

Configuration Procedure

- 12.3 Configuration
 - 12.3.1 Setup Flowchart
 - Redundant Configuration Using Automatic Setting
 - Controller Unique ID
 - Creating Primary and Secondary ID
 - Assigning a Logical Drive/Logical Volume to the Secondary Controller
 - Mapping a Logical Drive/Logical Volume to the Host LUNs
 - Terminal Interface View of Controller Failure
 - Forcing Controller Failover for Testing

12.1.1 Considerations Related to Physical Connection

Using SCSI-based Controllers

Figure 12 - 1 Dual-controller Setting Using SCSI-Based Controllers

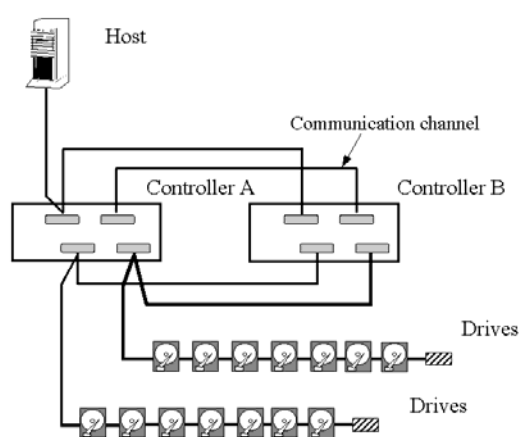

The physical connection between redundant controllers should be similar to the one shown above. The basic configuration rules are:

1. All channels should be connected to both controllers as diagrammed above or strung across via a common backplane. Disk drives or drive enclosures are connected to both controllers.

2. Cached writes are constantly duplicated in both controllers' memory over a dedicated SCSI channel. The default path for controller communications (SCSI-based controllers) is channel 0.

Channel 0 is also the default for the host interface; therefore, avail other channel(s) for host connection by changing its channel mode. See *Chapter 5* or *Chapter 7* for details about channel mode configuration.

3. SCSI channels should be terminated on both ends. It is recommended to use the termination jumpers on the controllers to configure the bus termination setting. SCSI terminators are provided on controllers' back-end PCBs. This design allows a controller to be removed during the controller failover process.

Using Fibre-based Controllers

The connection between controllers is more flexible with the Fibre-based controllers.

Figure 12 - 2 Dual-controller Setting Using Fibre-based Controllers

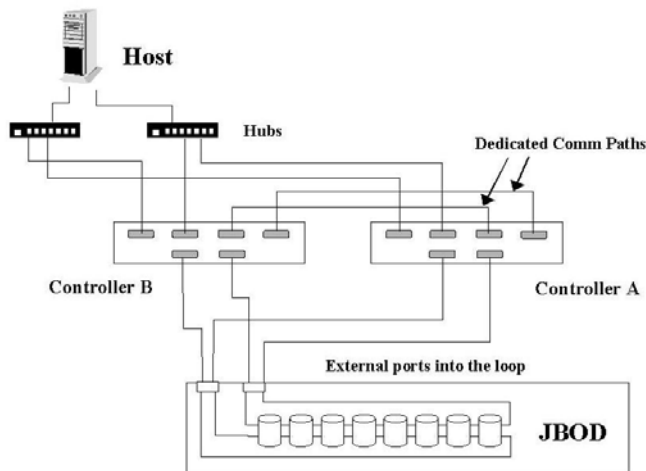

The basic configuration rules are:

1. All channels should be connected to both controllers as diagrammed above.
2. To reduce the chance of downtime, more than one hub or switch can be used to connect to the host computer(s) for path redundancy. Drive-side dual loop is supported. Host-side dual loop requires the support of host management software.

3. For the Fibre-to-Fibre controllers or RAID systems, there are two options with the communications loops between controllers:

1). Dedicated Communications Loops – “Dedicated RCC”

The first option is choosing one or two Fibre loops as the dedicated communications paths. Two is recommended for the path redundancy it provides.

Using two channels for communications offers greater throughput and therefore better performance.

2). Communications over Drive Loops – “Drive + RCC”

Configure all drive loops into the “Drive + RCC” mode to let them share the communications traffic. The controllers can automatically distribute the communications traffic across all drive loops.

Workflow is balanced among loops. Using the drive + RCC mode allows more channels to be used for drive connection. With a six-channel controller, for instance, there can be as many as two channels for host and four channels for drives (drive + RCC). All channels can be used for I/O traffic while the system is still benefits from controller communications.

12.1.2 Grouping Hard Drives and LUN Mapping

Listed below are the array setting options that need to be considered when planning a dual-controller system:

1. **How many logical drives, logical volumes, or logical partitions, and of what sizes?**
2. **System drive mapping (primary/secondary ID):** how many storage volumes will appear to which host port, and managed by which controller?
3. **Will those storage volumes be accessed in a multi-host or multi-path configuration? A shared storage volumes?**
4. **Fault Tolerance:** Configure the controllers so that they can failover and failback in a way transparent to host. See **12.1.3 Fault** Tolerance for more details.

Logical Drive, Logical Volume, and Logical Partitions

Listed below are the basics about configuring a logical drive for a redundant controller system:

- All configuration options are accessed through the Primary Controller. In redundant mode, two controllers behave as one, and there is no need to repeat the configuration on another controller.
- Disk drive and array configuration processes are the same for single or redundant controllers.
- Using logical configurations of drives as base units, system workload can be distributed to different controllers. Logical units can be manually assigned to different controllers to facilitate the active-active configuration.
- There is no limitation on drive allocations. The members of a logical drive do not have to come from the same drive channel. Grouping drives from different drive channels helps reduce the chance of downtime due to a channel bus failure.
- Each logical drive can be configured in a different RAID level and several logical drives can be striped across to compose a larger logical volume.
- Each of the logical units (logical drives, logical volumes, or one of their partitions) can be made available on host ports through host LUN mapping. Each of these associated host ID/LUNs appears as a virtual hard drive.

Figure 12 - 3 Grouping Hard Drives

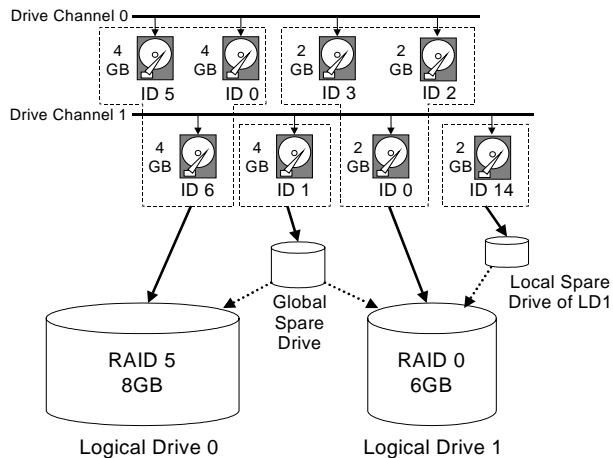

- As diagrammed above, choosing members to compose an array can be flexible. You may divide a logical drive or logical volume into several partitions as diagrammed below, or use the entire logical drive as a single partition, with or without the support of one or several spare drives.

Figure 12 - 4 Partitioning of Logical Units

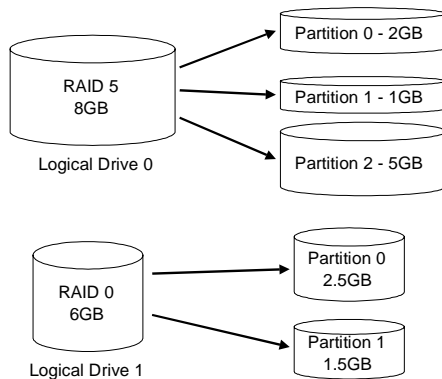

- Each logical unit can be associated (mapped) with a host ID (pre-configured as a Primary or Secondary ID) or the LUN numbers under host IDs.

System Drive Mapping

Primary and Secondary IDs

- **Host Channel**

When controllers are successfully combined, the array capacity is available through host port IDs, and these IDs are available as “Primary” or “Secondary” IDs.

- **Drive Channel**

Since all channels are strung between two controllers, each channel is connected to two chip processors, and each processor must occupy one channel ID. In redundant mode, both a Primary and a Secondary ID must be present on all drive channels.

- **Primary-Secondary Relationship**

The Primary-Secondary relationship between the controllers is automatically determined by the firmware. For some subsystem models, the relationship is determined by the controller slot. Refer to your hardware manual for details.

- **Create IDs**

You may have to create Primary and Secondary IDs separately on the host and drive channels if these IDs are not available. The configuration procedure will be discussed in *Section 12.3 Configuration*.

Mapping

- A logical unit made available through a Primary ID will be managed by the Primary Controller, and that through a Secondary ID by the Secondary Controller.
- Each channel ID (or an LUN under ID) will act as one virtual storage volume to the host computer.

Figure 12 - 5 Mapping System Drives (Mapping LUNs)

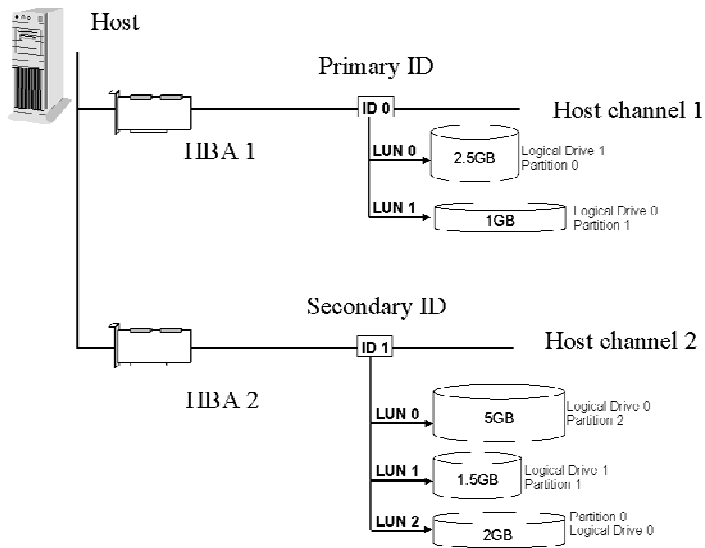

- The diagram above displays a single host computer with two HBA cards allowing the connection of dual I/O paths. A host port ID is presented on each host port as Primary ID or Secondary ID. Users may then map any logical configuration of drives to these ID or LUN numbers. The result is that workload can be distributed across two host ports and managed by both controllers.

Figure 12 - 6 Mapping System Drives (IDs)

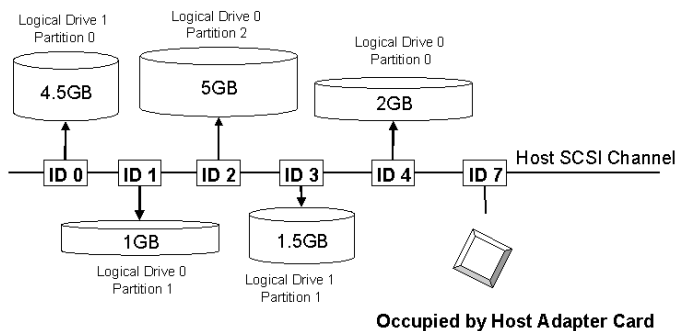

- Some operating systems do not read multiple LUNs under a single ID. As diagrammed above, you may have the host channel to present several IDs and map logical configurations to these IDs. Each of these IDs can be identified as Primary or Secondary. As a rule for most operating systems, each configuration unit will be mapped to LUN0 under each ID.

12.1.3 Fault Tolerance

What Is a Redundant Controller Configuration?

Hardware failures can occur. A simple parity error can sometimes cause a RAID system to completely hang up. Having two controllers working together will guarantee that at least one controller will survive catastrophes and keep the system working. This is the logic behind having redundant controllers - to minimize the chance of down time for a storage subsystem.

A redundant controller system uses two controllers to manage the storage arrays. It requires two controllers to work together and both must be working normally. During normal operation, each controller serves its I/O requests. If one controller fails, the existing controller will temporarily take over for the failed controller until it is replaced. The failover and failback processes are totally transparent to the host and require only minimum efforts to restore the original configuration.

How does Failover and Failback Work?

A. Channel Bus

Below is a sample illustration of the redundant controller operation:

Figure 12 - 7 Redundant Controller Channel Bus

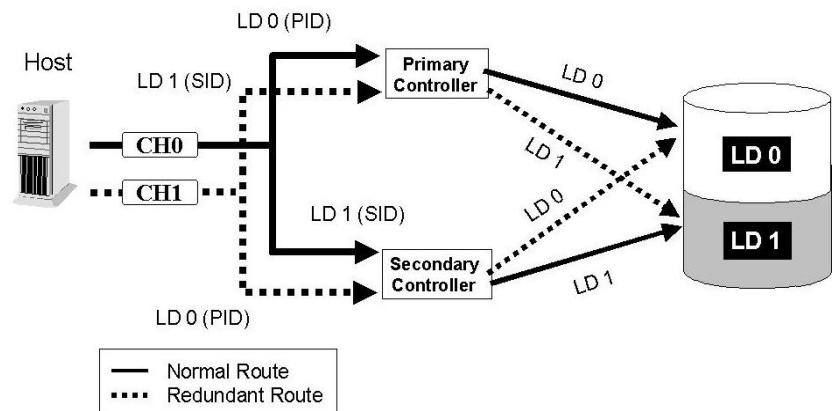

The host computer is connected to both the Primary and the Secondary Controllers. Each controller has two of its SCSI/Fibre channels assigned as the host channels, and the other SCSI/Fibre channels assigned to the drive connection.

There are two logical drives. Logical drive 0 is assigned to the Primary Controller (mapped to the Primary ID), and logical drive 1

assigned to the Secondary Controller (mapped to the Secondary ID). If one controller fails, the existing controller will manage the logical drive that belonged to the failed controller via the once inactive ID (the standby ID).

ID mapping is synchronized between the controllers. If one controller fails, the surviving controller still keeps a replica of all configuration data. The related ID mapping on the controllers should look like the tables below:

Table 12 - 1 ID Mapping Status (Normal Operation)

Channel	ID	Status	Target Chip
0	0 (Primary ID)	Active	Pri. Controller channel 0
	1 (Secondary ID)	Standby	Sec. Controller channel 0
1	1 (Secondary ID)	Active	Sec. Controller channel 1
	0 (Primary ID)	Standby	Pri. Controller channel 1

In the event of controller failure (say, the Primary controller fails), the once inactive ID (chip) will become active:

Table 12 - 2 ID Mapping Status (Controller Failed)

Channel	ID	Status	Target Chip
0	0 (Primary ID)	Active	Pri. Controller channel 0 - Failed!
	1 (Secondary ID)	Standby- becomes Active!	Sec. Controller channel 0
1	1 (Secondary ID)	Active	Sec. Controller channel 1
	0 (Primary ID)	Standby	Pri. Controller channel 1- Failed!

Figure 12 - 8 Controller Failover

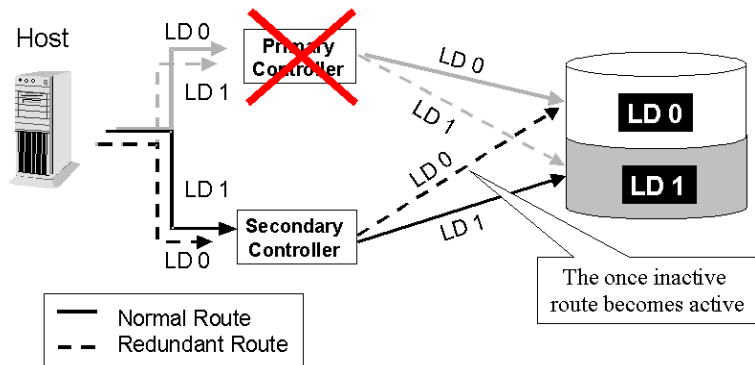

For every channel that is actively serving I/Os, there is another on the alternate controller that stays idle and will inherit the task should its counterpart fail.

As long as I/O bus bandwidth is not a concern, many active IDs can co-exist on single or multiple host channels. Standby chips may not be necessary.

B. Controller Failover and Failback

In an unlikely event of controller failure, the surviving controller will acknowledge the situation and disconnect from the failed controller. The surviving controller will then act as both controllers and serve all the host I/O requests.

System failover is transparent to host. System vendors should be contacted for an immediate replacement of the failed unit.

Replacing a Failed Unit:

Firmware Synchronization

The replacement controller should have the same amount of memory and run the same version of firmware. However, it is inevitable a replacement controller will be running later revisions of firmware. To solve this problem, **Firmware Synchronization** is supported on firmware versions 3.21 and later. When the replacement controller is combined, the existing controller will downgrade the replacement's firmware so that both controllers will be running the same version of firmware.

Your system vendor should be able to provide an appropriate replacement controller.

Rolling Firmware Upgrade

When upgrading firmware in a redundant controller system, the Primary Controller receives the new firmware. When appropriate time is found to reset both controllers, the Secondary Controller's firmware is upgraded.

If host access is stopped and then the firmware is upgraded, the controllers will flash new firmware and after the controller is reset, both controllers' firmware will be upgraded.

NOTE:

- Rolling firmware upgrade is not supported for controllers running firmware 3.27 and attempting to upgrade to firmware 3.31.
-

Auto-Failback

Once the failed controller is removed and a replacement controller is installed, the existing controller will acknowledge the situation. The existing controller should automatically attempt to combine with the replacement controller.

When the initialization process of the replacement controller is completed, the replacement controller will always inherit the status of the Secondary Controller. The replacement controller will obtain all related configuration parameters from the existing controller. If the existing controller fails to re-establish this connection, you can also choose to "de-assert" the replacement controller through the existing controller so that both will serve the original system drive mapping.

C. Active-to-Active Configuration:

Active-to-active configuration conducts all system resources to performance. Storage volumes can be equally assigned to both controllers and thus both are actively serving I/Os. This allows a flexible association between logical units and host ID/LUNs. Workload can then be manually distributed between controllers.

D. Traffic Distribution

The diagram below illustrates a four-channel configuration using channel 0 as the communications path. Channel 1 serves as the host interface and multiple IDs are created to facilitate active-active operation. Each controller occupies either a Primary ID or a

Secondary ID on drive channels. One logical unit is assigned to the Primary Controller and the other the Secondary Controller.

In the event when one controller fails, the existing controller will inherit IDs from the failed controller and continue I/Os.

Figure 12 - 9 Traffic Distribution

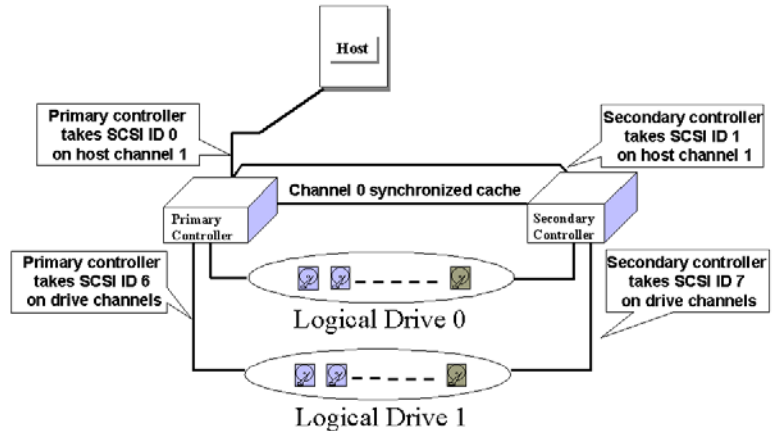

	Logical Drive 0	Logical Drive 1
Host LUN Mapping	ID0 / LUN* (PID)	ID1 / LUN* (SID)
Logical Drive Assignment	Primary	Secondary
Drive Channel	2	3

Users can assign a logical unit either to the Primary or to the Secondary Controller. Once the assignment is done, logical unit(s) assigned to the Primary Controller can only be mapped to the Primary IDs on the host channel; Logical unit(s) assigned to the Secondary Controller can only be mapped to the Secondary IDs on the host channel.

The channel ID (Primary/Secondary) assignment for a SCSI controller should look like this:

	Primary Controller ID	Secondary Controller ID
Host Chl SCSI ID	PID = 0	SID = 1
Drive Chl SCSI ID	7 (or 8 for the dual redundant chassis)	6 suggested (or 9 for the dual redundant chassis)

Figure 12 - 10 Controller Failover

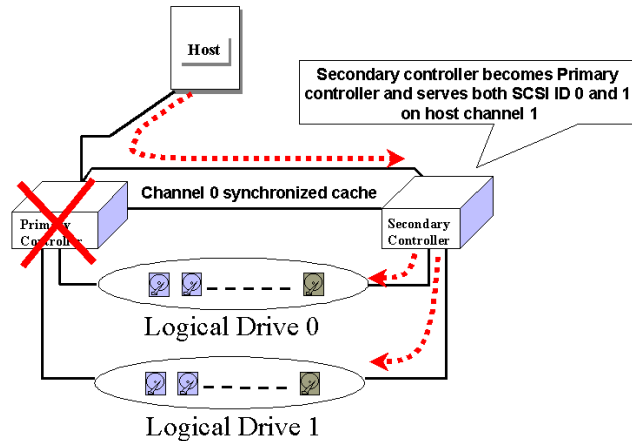

E. Controller Failure

Controller failure is managed by the surviving controller. The surviving controller disables and disconnects from its counterpart while gaining access to all signal paths. The existing controller then proceeds with the ensuing event notifications and take-over process. The existing controller is always the Primary Controller regardless of its original status and any replacement combined afterwards will assume the role of the Secondary.

Symptoms

- The LCD on the failed controller is off. The LCD on the surviving controller displays controller failure message.
- The surviving controller sounds an alarm.
- The "ATTEN" LED is flashing on the existing controller.
- The surviving controller sends event messages to notify of controller failure.

Connection

The channels of the two controllers that are connected together must be the same. For example, if controller A uses channel 2 to connect a group of drives, controller B must also use channel 2 to connect to the same group of drives.

12.2 Preparing Controllers

12.2.1 Requirements

Cabling Requirements

Communications Channels

- Controller Communications (Cache Synchronization) Paths:

Controller	RCC cable
SentinelRAID	A SCSI cable (CH 0)
EonRAID 2510FR	Dedicated RCC or RCC over drive loops
EonStor	Pre-configured RCC routes over the system backplane

- Using one or two of the I/O channels for controller communications (as listed above) is necessary especially when write-back caching is preferred. If controllers are running in write-back mode, a battery module is recommended for each controller.
-

Out-of-Band Configuration

- RS-232C cable (for Terminal Interface Operation) connection.
- Ethernet connection: If management through Ethernet is preferred, connect the Ethernet interface from both controllers to ports on a hub. In the event of controller failure, the IP address assigned to the Primary Controller will be inherited by the surviving controller. The Ethernet port connection will be continued.

Controller Settings: General Procedure

1. *Enable Redundant Controller*

"Main Menu"→ "View and Edit Peripheral Devices"→ "Set Peripheral Device Entry"→ "Redundant Controller Enable/Disable"

2. *Controller Unique Identifier*

Set unique identifier to each controller. "View & Edit Peripheral Devices"→ "Set Peripheral Device Entry"→ "Controller Unique Identifier." Enter a hex number between 0 and FFFFF (firmware 3.25 and above) for each controller.

3. *Creating Primary and Secondary IDs on Drive Channels*

"View and Edit SCSI Channels"→ Choose a Drive Channel→ "Primary/Secondary Controller SCSI ID."

4. *Creating Primary and Secondary IDs on Host Channels*

"View and Edit SCSI Channels"→ Choose a host channel→ "View and Edit SCSI ID"→ Choose a SCSI ID→ "Add/Delete Channel SCSI ID"→ "Primary/Secondary Controller"→ Add SCSI ID from the list. Reset the controller for the configuration to take effect.

5. *Creating Logical Configurations of Drives and Assigning Each of Them Either to the Primary or the Secondary Controller*

"View and Edit Logical Drives"→ Select a RAID level→ Select member drives→ "Logical Drive Assignments"→ Create Logical Drive.

6. *Map Each Logical Configuration of Drives to the Primary/ Secondary ID on host channel(s)*

"View and Edit Host LUN"→ Choose a "Host Channel-ID-Controller" Combination→ Choose Logical Drive/Logical Volume/Physical SCSI Drive→ Map to Host LUN (Create Host LUN Entry).

NOTE:

- *The redundant controller function can be enabled via the front keypad or a terminal emulation program. Section 12.3 **Configuration** describes the procedures for using terminal emulation and the LCD front panel. The same result can be achieved regardless of the interface used.*
-

12.2.2 Limitations

- Both controllers must be exactly the same. Namely, they must operate with the same firmware version, the same size of memory, the same number of host and drive channels, etc. If battery backup is preferred, both should be installed with a battery module.
- The takeover process should take less than one second (using SCSI or Fibre for controller communications) to complete.
- In redundant mode, each controller takes an ID on each channel bus. This means the maximum number of disk drives on a SCSI bus is 14.
- Connection through Fibre hubs or switches is necessary for joining host (Fibre) interfaces between controllers. The EonRAID 2510FR is an exception. Its type-1 ports come with an onboard hub.
- The controller defaults for ID settings are listed below:

Host interface	Host channel (Primary/Secondary)	Drive channel (Primary/Secondary)
SCSI	0 / 1...	7 / 6
Fibre	112 / 113...	119 / 120

- SCSI IDs 8 (PID) and 9 (SID) are the recommended defaults to the drive channels of the SCSI-based dual-controller chassis using an integrated backplane.

12.2.3 Configurable Parameters

Primary or Secondary

If necessary, users can specify a particular controller as Primary or Secondary. By setting each controller to the "Autocfg" mode, the controllers will decide between themselves which is the Primary and which is the Secondary.

The controller firmware recognizes the two controllers used in a redundant configuration as Primary or Secondary. Two controllers behave as one Primary Controller.

Once the redundant configuration takes effect, user's configurations and settings can only be done on the Primary Controller. The Secondary Controller then synchronizes with the configuration of the Primary controller, making the configurations of two controllers exactly the same.

The two controllers continuously monitor each other. When a controller detects that the other controller is not responding, the working controller will immediately take over and disable the failed controller. However, it is not predictable which one of the controllers will fail. It is necessary to connect all other interfaces to both controllers so that a surviving controller can readily continue all the services provided for the RAID system.

Active-to-Active Configuration

Users can freely assign any logical configuration of drives to both or either of the controllers, then map the logical configurations to the host channel IDs/LUNs. I/O requests from host computer will then be directed to the Primary or the Secondary Controller accordingly. The total drive capacity can be divided and equally serviced by both controllers.

The active-to-active configuration engages all system resources to performance. Users may also assign all logical configurations to one controller and let the other act as a standby.

Active-to-Standby Configuration

By assigning all the logical configurations of drives to one controller, the other controller will stay idle and becomes active only when its counterpart fails.

Cache Synchronization

The Write-back caching significantly enhances controller performance. However, if one controller fails in the redundant controller configuration, data cached in its memory will be lost and data inconsistency might occur when the existing controller attempts to complete the writes.

Data inconsistency can be avoided using one or several of the I/O channels as the communications path between the controllers. The cached data is always synchronized in each other's memory. Each controller saves an exact replica of the cache content on its counterpart. In the event of controller or power failure, the unfinished writes will be completed by the existing controller.

Battery Support

Unfinished writes will be cached in memory in write-back mode. If power to the system is discontinued, data stored in the cache memory will be lost. Battery modules can support cache memory for a period of several days allowing the controller to keep the cached data. When two controllers are

operating in write-back mode, it is recommended to install a battery module in each controller.

12.3 Configuration

Listed below are the steps necessary to configure a redundant controller system:

1. Separately configure each controller in the "**Autoconfig**" mode. When the two controllers are powered on later, the firmware will determine which is the Primary Controller.
2. If a channel is used as the communications channel, the firmware will display the channel status as "**RCCOM** (Redundant Controller Communications)." This channel will then be excluded from the use of the host/drive connection.
3. When powering on both controllers together, the LCD will display "**RC connecting**." After the controller negotiation is completed, the communications between controllers should be established.
4. Configure your SCSI/Fibre channels as host or drive. The default configuration for SCSI channel termination is "enabled." Please refer to your controller/subsystem *Installation and Hardware Reference Guide* and examine whether the termination jumpers on the controller backplane are shunted. If the associated jumpers are shunted, the SCSI channels will be terminated on the controller side no matter the firmware setting is "enabled" or "disabled."
5. Create both a "Primary ID" and a "Secondary ID" on every drive channel.
6. Reset the controller for the configuration to take effect.
7. Create Logical drives/logical volumes and assign each logical unit to the Primary or to the Secondary Controller.
8. Proceed with host LUN mapping. After mapping each logical unit to a Primary or Secondary ID/LUN on the host channel(s), the redundant controller configuration is complete.

12.3.1 Setup Flowchart

Figure 12 - 11 Redundant Controller Configuration Flowchart

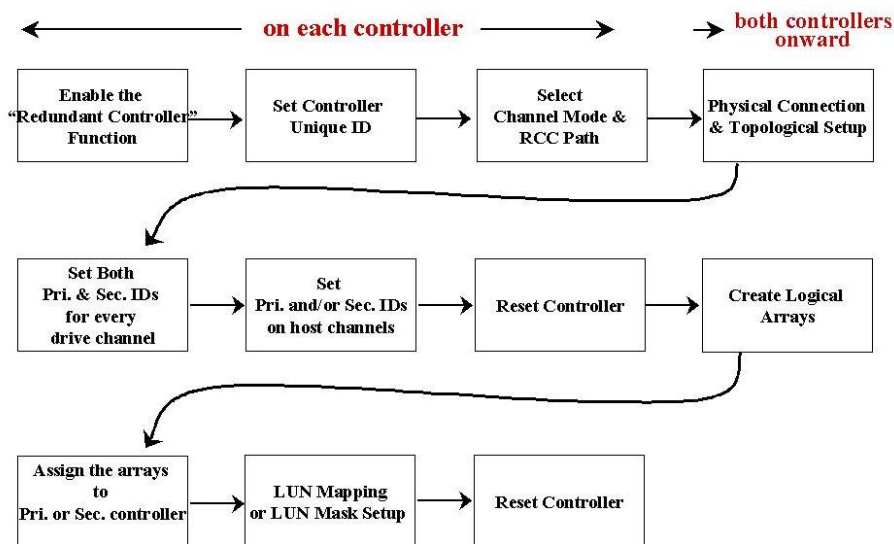

NOTE:

Some of Infotrend's dual controller configurations come with preset IDs for users' ease of configuration. It is, however, always best to check these IDs before proceeding with configuration.

12.3.2 Via Front Panel Keypad

Redundant Configuration Using Automatic Setting

Power on Controller 1. Make sure Controller 2 is powered off.

1. Enable Redundant Controller

Press [ENT] for two seconds on the front panel of Controller 1 to enter the Main Menu. Use the up or down arrow keys to navigate through the menus. Choose "View and Edit Peripheral Dev,"

View and Edit
Peripheral Dev

then press [ENT]. Choose "Set Peripheral Devices Entry," then press [ENT].

Set Peripheral
Devices Entry

Choose "Redundant Ctlr Function__", and then press [ENT]. (NOTE: The current setting will be displayed on the LCD.) If this controller has never been set as a redundant controller before, the default setting of the redundant controller function is "Disabled." The message "Redundant Ctlr Function Disable" will be displayed on the LCD. Press [ENT] to proceed.

```
Redundant Ctlr
Function Disable
```

Autoconfig.

The message "Enable Redundant Ctlr: **Autocfg**?" will appear. Use the up or down arrow keys to scroll through the available options ("Primary," "Secondary," or "Autocfg"), then press [ENT] for two seconds to select "Autocfg."

```
Enable Redundant
Ctlr: Autocfg ?
```

If the other controller is currently not connected, its status will be indicated as "Inactive." Once set, press [ESC] several times to return to the Main Menu.

```
Redundant Ctlr:
Autocfg Inactive
```

2. Controller Unique ID

Enter "View and Edit Config Parm"->"Controller Parameters". Use the up or down arrow keys to find "Ctlr Unique ID- xxxxx".

```
View and Edit
Config Parm
```

```
Controller
Parameters ..
```

This value will be used to generate a controller-unique WWN node name and port names and to identify the controller during the failover process. Enter a hex number from 0 to FFFFF and press [ENTER]. The value you enter should be different for each controller.

```
Ctlr Unique
ID- 00012 ?
```

Power off Controller 1, and then power on Controller 2. Set Controller 2 to "Autocfg" as described previously. Power off Controller 2.

When the redundant controller function is set to the "Autocfg" setting, the controllers will decide between themselves which will be the Primary controller. If you need to specify a particular controller as Primary or Secondary, do not set it as "autocfg;" choose "Primary" or "Secondary" instead. Please refer to the following section for more detail.

Redundant Configuration Using Manual Setting

Power on Controller 1. Make sure Controller 2 is powered off.

1. Enable Redundant Controller

Press [ENT] for two seconds on the front panel of Controller 1 to enter the main menu. Use the up or down arrow keys to navigate through the menus. Choose "View and Edit Peripheral Dev," then press [ENT].

```
View and Edit  
Peripheral Dev
```

Choose "Set Peripheral Device Entry," then press [ENT].

```
Set Peripheral  
Devices Entry
```

Choose "Redundant Ctlr Function__," and then press [ENT]. (NOTE: The current setting will be displayed on the LCD). If this controller has never been set as a redundant controller before, the default setting of the redundant controller function is "disabled." The message "Redundant Ctlr Function Disable" will be displayed on the LCD screen. Press [ENT] to proceed.)

```
Redundant Ctlr  
Function Disable
```

The message "Enable Redundant Ctlr: Autocfg?" will appear. Use the up or down arrow keys to scroll through the available options ("Primary," "Secondary," or "Autocfg"). Press [ENT] for two seconds on "Primary."

```
Enable Redundant  
Ctlr: Autocfg ?
```

2. Controller Unique ID

Enter "View and Edit Config Parm"-> "Controller Parameters". Use the up or down arrow keys to find "Ctlr Unique ID- xxxxx".

```
View and Edit  
Config Parm
```

```
Controller  
Parameters ..
```

This value will be used to generate a controller-unique WWN node name and port names and to identify the controller during the failover process. Enter a hex number from 0 to FFFFF and press [ENTER]. The value you enter should be different for each controller.

```
Ctlr Unique  
ID- 00012 ?
```

Power off Controller 1, then power on Controller 2. Set Controller 2 to "Secondary" as described above.

Power off Controller 2.

Starting the Redundant Controllers

Power on all hard drives and the two controllers. If drives are installed in a drive enclosure, wait for the drives to be ready, then power on the enclosure where the RAID controllers are installed.

```
RC connecting...  
<ENT> to cancel
```

The message "RC (redundant controller) connecting... <ENT> to cancel" will appear on the LCD display of the two controllers. After a few seconds, the Primary Controller will startup with the model number and firmware version displayed on the LCD, while the Secondary Controller will display the message "RC Standing By.. <ENT> to Cancel" on its LCD.

A few seconds later, the LCD display on the Secondary Controller will be similar to the LCD display on the Primary Controller. The upper right corner of LCD will then display a "P" or "S," meaning "Primary" or "Secondary" respectively.

During normal operation, the controllers continuously monitor each other. Each controller is always ready to take over for the other controller in the unlikely event of a controller failure.

The Primary and Secondary Controllers synchronize each other's configurations at frequent intervals through the communications channel(s).

Creating Primary and Secondary ID

Drive Channel

Enter "View and Edit SCSI Channels." Press [ENT] and use the up or down arrow keys to select the host or drive channel on which you wish to create Primary/Secondary IDs.

```
View and Edit  
SCSI Channels .
```

```
CH1=Drive PID=7  
SID=NA SXF=80.0M
```

Press [ENT] to proceed.

Use the up or down arrow keys to select "Set SCSI Channel Pri. Ctlr ID .." or "Set SCSI Channel Sec. Ctlr ID ..." Press [ENT] to proceed.

```
Set SCSI Channel  
Sec. Ctlr ID ..
```

Use the up or down arrow keys to select a SCSI ID and press [ENT] to confirm. The configuration change will take effect only after the controller has been reset.

```
Set Sec. Ctlr  
ID:NA to ID: 6?
```

Host Channel

The process of creating Primary and Secondary IDs on host channels is basically the same.

```
CHL=0 ID=0  
Primary Ctlr ..
```

In "View and Edit SCSI Channels", press [ENT] to select a host channel. Use the up or down

arrow keys to select "Set SCSI Channel ID". A pre-configured ID will appear, press [ENT] to proceed. Use the up or down arrow keys to select "Add Channel SCSI ID" and then press [ENT] for two seconds on the "Primary Controller" or "Secondary Controller?" to proceed.

```
Add Channel
SCSI ID    ..
```

```
Primary
Controller ?
```

When prompted by this message, use the up or down arrow keys to select an ID. Press [ENT] to confirm.

```
Add CHL=0 ID=2
Primary Ctlr  ?
```

A message will prompt to remind you to reset the controller. Press [ENT] to reset the controller or press [ESC] to move back to the previous menu. The change of ID will only take effect after the controller has been reset.

```
Change Setting
Do Reset Ctlr ?
```

Assigning a Logical Drive/Logical Volume to the Secondary Controller

A logical drive, logical volume, or any of its logical partitions can be assigned to the Primary or Secondary Controller. By default, a logical drive is automatically assigned to the Primary Controller. It can be assigned to the Secondary Controller if the host computer is also connected to the Secondary Controller.

Note that the partitions of a logical drive that has previously been assigned to the Secondary controller will automatically be assigned to the Secondary Controller.

Press [ENT] for two seconds on the front panel of the Primary controller to enter the Main Menu.

Use the up or down arrow keys to navigate through the menus. Choose "View and Edit Logical Drives", then press [ENT].

```
View and Edit
Logical Drives
```

Create a logical drive or choose an existing logical drive, then press [ENT] to see the logical drive menu.

Choose "Logical Drive Assignment..," then press [ENT].

```
Logical Drive
Assignment..
```

The message "Redud Ctlr LG Assign Sec Ctlr?" will appear. Press [ENT] for two seconds to confirm. The logical drive has now been assigned to the Secondary Controller.

```
Redud Ctlr LG
Assign Sec Ctlr?
```

Map the logical drive (or any logical unit) to a host ID or LUN number under the designated Secondary controller ID. The host channel must have a "Secondary" SCSI ID created. (Create the Secondary controller's SCSI ID on host channel and add a SCSI ID to every drive channel in "View and Edit SCSI Channels").

Mapping a Logical Drive/Logical Volume to the Host LUNs

Choose "View and Edit Host Luns" from Main Menu and press [ENT] to proceed.

```
View and Edit
Host Luns
```

Use the up or down arrow keys to navigate through the created IDs and press [ENT] to select one of them. Note that a logical unit previously assigned to a Primary Controller can only be mapped a Primary ID, and vice versa.

```
Map Sec Ctlr
CH=0 ID= 000 ?
```

Use the up or down arrow keys to choose mapping "Logical Drive," "Logical Volume," or "Physical Drive" to host LUN. If the logical unit has been partitioned, map each partition to different ID/LUNs.

```
Map to
Logical Drive ?
```

Use the up or down arrow keys to choose a LUN number and press [ENT] to confirm.

```
CH0 ID0 LUN0
No Mapped
```

Press [ENT] again to confirm.

```
Map Host LUN ?
```

Use the up or down arrow keys to select a logical drive/logical volume if there are many.

```
LG0 RAID5 DRV=3
9999MB GD SB=0
```

Press [ENT] and choose a partition if the logical unit has been partitioned.

```
LG=0 PART=0
999MB ?
```

Press [ENT] again to confirm or scroll down to "Edit Host Filter Parameter ...". You may refer to *Chapter 8* for more details.

```
Map Host LUN ?
```

Press [ENT] to confirm the mapping.
Press [ENT] to re-ensure.

```
CH0 ID9 LUN0 Map
to LG0 PRT0?
```

This message indicates that the logical unit has been successfully mapped to the ID/LUN combination. Use the up or down arrow keys to continue mapping other logical units or press [ENT] to delete the mapped LUN.

```
Map Sec. Ctlr
CH=0 ID= 0 ?
```

```
CH0 ID9 LUN0
Mapto LG0 PRT0
```

Repeat the process to map all the logical units to host ID/LUNs.

Front Panel View of Controller Failure

What will happen when one of the controllers fails?

If one of the controllers fails, the existing controller will automatically take over within a few seconds.

The red ATTEN LED will light up, and the message "Redundant Ctlr Failure Detected" will appear on the LCD. Users will be notified by audible alarm.

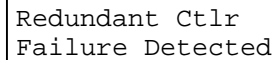

Redundant Ctlr
Failure Detected

NOTE:

- *Although the existing controller will keep the system working, you should contact your system vendor for a replacement controller as soon as possible. Your vendor should be able to provide the appropriate replacement unit.*
- *Some operating systems (SCO, UnixWare, and OpenServer, for example) will not attempt to retry accessing the hard disk drives while controller is taking over.*

When and how is the failed controller replaced?

Remove the failed controller **after** the "working" controller has taken over. For a controller with hot-plug capability, all you have to do is to remove the failed controller.

The replacement controller has to be pre-configured as the "Secondary Controller." (The replacement controller provided by your supplier should have been configured as the Secondary Controller. It is recommended to safety check the status of the replacement controller before installing it to your redundant system. Simply attach power to the replacement and configure it as "Secondary." When the safety check is done, remove the failed controller and install the replacement controller into its place.)

By setting a replacement as a "Secondary Controller" its "redundant controller" function is activated.

When the replacement is connected, the "Auto-Failback" will start automatically. If the replacement controller does not initialize, execute the following steps to bring the new controller online. Press [ENT] for two seconds on the existing controller to enter the Main Menu.

Use the up or down arrow keys to select "View and Edit Peripheral Dev.," then press [ENT].

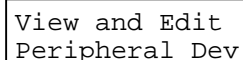

View and Edit
Peripheral Dev

Choose "Set Peripheral Device Entry..," then press [ENT].

```
Set Peripheral
Devices Entry ..
```

Choose "Redundant Ctlr Function__," then press [ENT].

```
Redundant Ctlr
Function__
```

The message "Redundant Ctlr Autocfg Degraded" will appear on the LCD.

```
Redundant Ctlr
Autocfg Degraded
```

Press [ENT] and the message "Deassert Reset on Failed Ctlr?" will appear.

```
Deassert Reset
on Failed Ctlr?
```

Press [ENT] for two seconds and the controller will start to scan for the new controller and bring it online.

```
Redundant Ctlr
Scanning
```

The new controller will then start to initialize.

```
Initializing...
Please Wait...
```

Once initialized, it will assume the role of the Secondary Controller.

```
SR2500F v3.**
■■■■■■■■
```

12.3.3 Via Terminal Emulation

Redundant Configuration Using Automatic Setting

Power on Controller 1. Make sure Controller 2 is powered off.

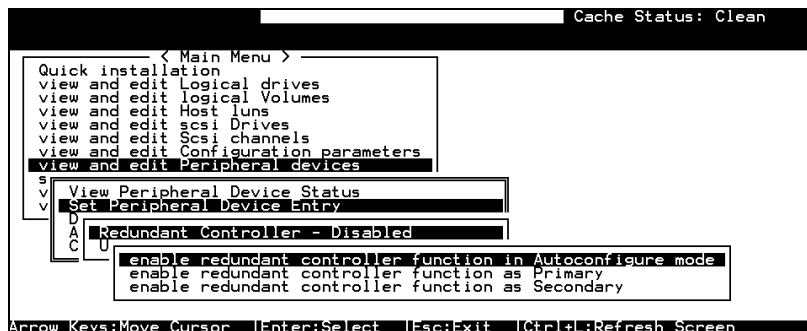

Enter the Main Menu.

Use the arrow keys to navigate through the menus. Choose "View and Edit Peripheral Devices," then press [ENTER].

Choose "Set Peripheral Devices Entry," then press [ENTER]. Choose "Redundant Controller [Function]," and then press [ENTER]. (NOTE: The

current setting will be displayed on the screen. If this controller has never been set as a redundant controller before, the default setting is "Disabled." The message "Redundant Controller - Disabled" will be displayed on the screen. Press [ENTER] to proceed.)

The message "Enable Redundant Controller in **Autoconfigure** Mode" will appear.

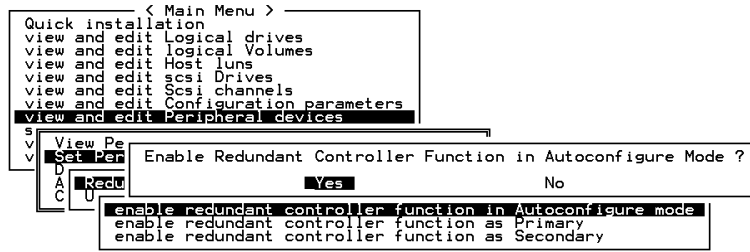

Use the arrow keys to scroll through the available options ("Primary," "Secondary," or "Autoconfigure"), then press [ENTER] to select "Autoconfigure." When prompted by "Enable Redundant Controller Function in Autoconfigure Mode?," choose Yes.

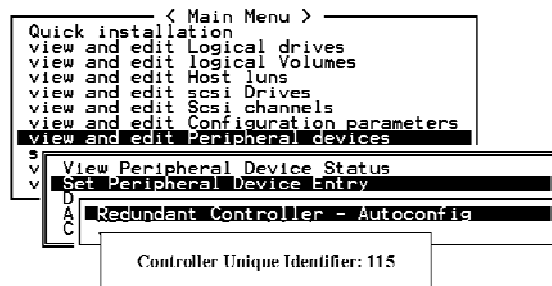

A "Controller Unique Identifier" box will appear. Enter a hex number from 0 to FFFFF, then press [ENTER] to proceed. The value you enter for controller unique ID should be different for each controller.

Power off Controller 1, and then power on Controller 2. Set Controller 2 to "Autoconfigure" as described in the steps mentioned above. Power off Controller 2.

When the redundant controller function is set to the "Automatic" setting, the controllers will decide between themselves which will be the Primary Controller. If you need to specify a particular controller as Primary or Secondary, do not set it as "Autocfg;" choose "Primary" or "Secondary" instead.

Redundant Configuration Using Manual Setting

Power on Controller 1. Make sure controller 2 is powered off.

Enter the Main Menu. Use the arrow keys to navigate through the menus. Choose "View and Edit Peripheral Devices," then press [ENTER].

Choose "Set Peripheral Device Entry," then press [ENTER].

[ENTER] to see the logical drive menu. Choose "Logical Drive Assignments," then press [ENTER]. Choose **Yes** and press [ENTER] to confirm reassignment to the Secondary Controller.

Q	LG	ID	LV	RAID	Size(MB)	Status	0	#LN	#SB	#FL	NAME
v	P0	1F10E040	NA	RAID5	9998	GOOD	S	3	1	0	
v	View scsi drives										
v	Delete logical drive										
v	Partition logical drive										
v	logical drive Name										
v	Logical Drive Assignments										
v	Redundant Controller Logical Drive Assign to Secondary Controller ?										
v	Yes No										
v	6		NONE								
v	7		NONE								

The reassignment is evident from the "View and Edit Logical Drives" screen. "S0" indicates that the logical drive is Logical Drive 0 assigned to the Secondary Controller.

Q	LG	ID	LV	RAID	Size(MB)	Status	0	#LN	#SB	#FL	NAME
v	S0	1F10E040	NA	RAID5	98	GOOD	S	3	1	0	
v	P1	4DB655C0	NA	RAID3	98	GOOD	S	3	0	0	
v	2		NONE								
v	3		NONE								
v	4		NONE								
v	5		NONE								
v	6		NONE								
v	7		NONE								

Mapping a Logical Drive/Logical Volume to the Host LUNs

Cache Status: Clean

< Main Menu >

- Quick installation
- view and edit logical drives
- view and edit logical volumes
- view and edit host luns
- CHL 0 ID 0 (Primary Controller)
- Edit Logical Drive
- Logical Volume
- system
- view sy
- view and edit event logs

← Choose host channel-ID

← Choose mapping to which logical unit

Select LUN number →

LUN	LV/LD	DRV	Partition	Size(MB)	RAID
0					

Select partition →

LG	ID	LV	RAID	Size(MB)	Status	0	#LN	#SB	#FL	NAME	
P0	737BD0F51	NA	RAID5	98	GOOD	S	3	0	0		
				Partition	Offset(MB)	Size(MB)					
				0	0	98					

Mapping option →

Map Host LUN

Create Host Filter Entry

Confirming mapping scheme →

Map Logical Drive: 0

To Partition : 0

Channel : 0

ID : 0

Lun : 0 ?

Yes No

Terminal Interface View of Controller Failure

What will happen when one of the controllers fails?

When one of the controllers fails, the other controller will take over in a few seconds.

Warning

```
[110F] CHL:0 SCSI Drive Channel ALERT: SCSI Bus Reset Issued
```

A warning will be displayed that a "SCSI Bus Reset Issued" for each of the SCSI channels.

In addition, there will be an alert message that reads "Redundant Controller Failure Detected."

Users will be notified by audible alarm.

Alert

```
[0111] Controller ALERT: Redundant Controller Failure Detected
```

After a controller takes over, it will act as both controllers. If the Primary Controller failed, the Secondary Controller becomes the Primary Controller. If the failed controller is replaced by a new one later, the new controller will assume the role of the Secondary Controller.

NOTE:

- *Some operating systems (SCO, UnixWare, and OpenServer, for example) will not attempt to retry accessing the hard disk drives while the controller is taking over.*
-

12.3.4 When and How Is the Failed Controller Replaced?

Remove the failed controller **after** the take-over of the "working" controller has been completed. For a controller with hot-plug capability, all you have to do is to remove the failed controller.

The new controller has to be pre-configured as the "Secondary Controller." (The replacement controller provided by your supplier should have been configured as the Secondary Controller. It is recommended to safety check the status of the replacement controller before installing it to your redundant system. Simply attach power to the new controller and configure it as the "Secondary." When the safety check is done, remove the failed controller and install the replacement controller into its place.)

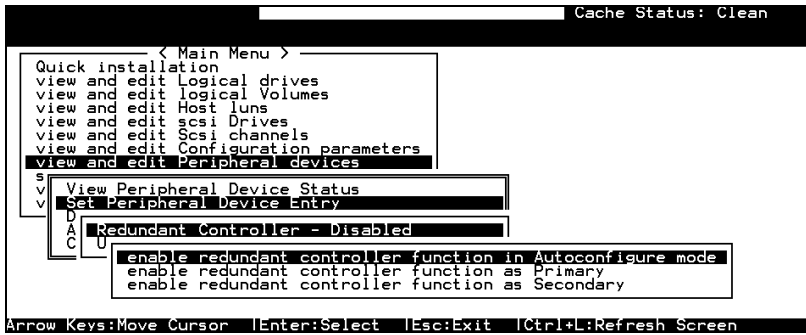

When the new controller is connected, the existing controller will automatically start initializing the replacement controller. If the existing controller does not initialize the replacement controller, execute the "Deassert Reset on Failed Controller" function.

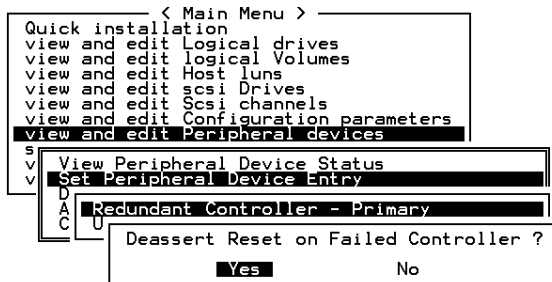

If the replacement has been initialized normally, you may proceed to examine the system status. From the Main Menu, select "View and Edit Peripheral Devices" and then "View Peripheral Device Status" to see that the new controller is being scanned.

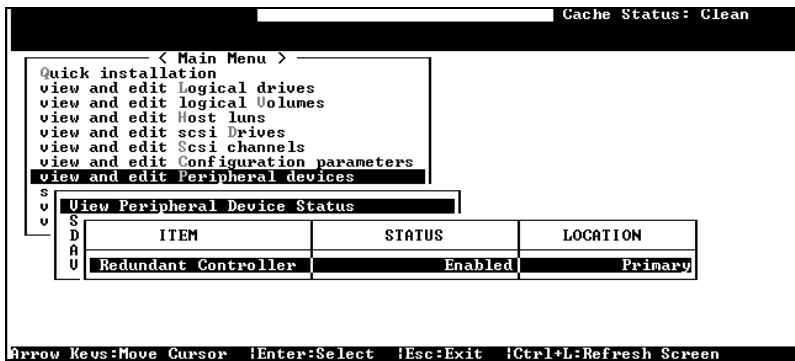

When the scanning is completed, the status will change to "Enabled."

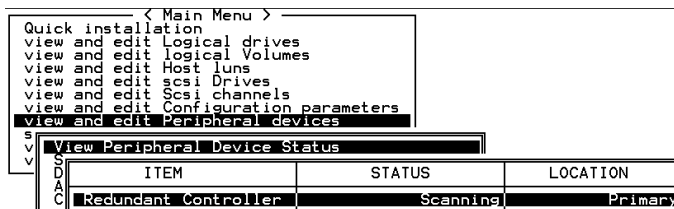

Forcing Controller Failover for Testing

```
< Main Menu >
Quick installation
view and edit Logical drives
view and edit logical Volumes
view and edit Host luns
view and edit scsi Drives
view and edit Scsi channels
view and edit Configuration parameters
view and edit Peripheral devices
S
U
V
D
A
C
U
View Peripheral Device Status
Set Peripheral Device Entry
Redundant Controller - Primary
Disable redundant controller
force Primary controller failure
force Secondary controller failure
```

This function is reserved for de-bugging.

Testing the failover functionality can be performed using the following methods.

1. Pulling out one of the controllers to simulate controller failure

Pull out either the Primary or the Secondary Controller. An error message will display immediately and an alarm will sound. The existing controller takes over the workload within a second. Clear all errors by pressing the **ESC** key. You may re-install the removed controller after all activities have been taken over by the existing controller. It may take a while for the controllers to finish re-initialization and assuming their load.

2. "Forcing controller failure"

Select "View and Edit Peripheral Devices," "Set Peripheral Device Entry," and "Redundant Controller Primary/Secondary."

Select "Force Primary/ Secondary Controller Failure." You may now pull out the controller you had just disabled. I/Os should be continued by the existing controller. Continue the aforementioned procedure to complete the test.

WARNING!

- *This function should only be performed for testing the redundant controller functionality before any critical data is committed to the drives. Although the controller is designed to be hot-swappable, unpredictable failures may occur during the process, e.g., improper handling of PCB boards while replacing the controller.*
-

RCC Status (Redundant Controller Communications Channel)

```
Wed Jun 26 17:10:48 2002 Cache Status: Clean
Write Cache: Enable
BAT:+++++
< Main Menu >
Quick installation
view and edit Logical drives
view and edit logical Volumes
view and edit Host luns
view and edit scsi Drives
view and edit Scsi channels
view and edit Configuration parameters
v
s C Redundant Controller Communication Channel - Fibre
v H Secondary Controller RS-232 - Disabled
v D Remote Redundant Controller - Disabled
D Cache Synchronization on Write-Through - Disable
Redundant Controller Parameters
Controller Parameters

Arrow Keys:Move Cursor |Enter:Select |Esc:Exit |Ctrl+L:Refresh Screen
```

This item is for display only, showing the current communications route.

Secondary Controller RS-232

This is an option reserved for debugging purposes. When enabled, you can access the Secondary Controller through its serial port. In a redundant controller system, only status display is available through the terminal session with a Secondary Controller. No configuration change can be done through a Secondary Controller.

Remote Redundant Controller

```
< Main Menu >
Quick installation
view and edit Logical drives
view and edit logical Volumes
view and edit Host luns
view and edit scsi Drives
view and edit Scsi channels
view and edit Configuration parameters
v
s C Redundant Controller Communication Channel - Fibre
v H Secondary Controller RS-232 - Disabled
v D Remote Redundant Controller - Disabled
D Cache Synchronization on Write-Through - Disable
Redundant Controller Parameters
Controller Parameters
```

This function enables two partner controllers to be connected by FC links over an extended distance, e.g., between two campus buildings. This is an advanced option reserved for system integrators. For more details, please contact Infotrend Technical Support.

Cache Synchronization on Write-Through

```
Cache Status: Clean
Write Cache: Enable

< Main Menu >
Quick installation
view and edit Logical drives
view and edit Logical Volumes
view and edit Host luns
view and edit scsi Drives
view and edit Scsi channels
view and edit Configuration parameters

V
C
S
C
H
D
D
D
Redu
Cont
Enable Cache Synchronization on Write-Through ?
Yes No

Arrow Keys:Move Cursor |Enter:Select |Esc:Exit |Ctrl+L:Refresh Screen
```

If your redundant controller system is not operating with Write-back caching, you can disable synchronized cache communications. Your system can be spared the effort to mirror and transfer data between partner controllers. This increases array performance for subsystems that operate without write-caching.

Record of Settings

In addition to saving the configuration data in NVRAM to disk, keeping a hard copy of the controller configuration is also recommended. This will speed the recreation of the RAID in the event of a disaster.

The following tables are provided as a model for recording the configuration data.

As a general rule, the configuration data in the NVRAM should be saved to disk or as a file (using RAIDWatch Manager) whenever a configuration change is made.

13.1 View and Edit Logical Drives

Wed Jun 26 16:38:24 2002											Cache Status: Clean			
BAT:											Write Cache: Enable			
LG	ID	LV	RAID	Size(MB)	Status	1	2	3	0	C	#LN	#SB	#FL	NAME
P0	20F7C6C5	NA	RAID0	277976	GOOD				7		8	-	0	
P1	6520CBA0	NA	RAID5	69694	GOOD				7		3	0	0	
2			NONE											
3			NONE											
4			NONE											
5			NONE											
6			NONE											
7			NONE											

Arrow Keys:Move Cursor |Enter:Select |Esc:Exit |Ctrl+L:Refresh Screen

Logical Drive Information

LG	ID	LV	RAID Level	Size (MB)	Status	1	2	3	0	C

13.3 View and Edit Host LUN's

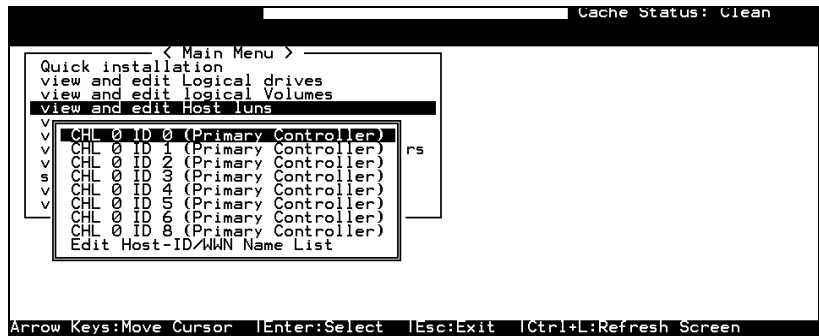

LUN Mappings

Host Channel	Pri. / Sec. Controller	SCSI ID	LUN	Logical Drive / Logical Volume	Partition	Size

Host-ID/WWN Name List

Host-ID/WWN	Name List

Access Restriction Setting

Logical Drive / Logical Volume	Partition	Read Only / Access Denied to / R/W by HBA WWN List

13.5 View and Edit SCSI Channels

Cache Status: Clean

Q	Ch1	Mode	PID	SID	DefSynC1k	DefWid	S	Term	CurSynC1k	CurWid
v	0(D)	RC00M								
v	1	Drive	7	6	20.0MHz	Wide	S	0n	40.0MHz	Narrow
v	2	Drive	7	6	40.0MHz	Wide	L	0n	40.0MHz	Narrow
v	3	Drive	7	6	40.0MHz	Wide	L	0n	40.0MHz	Narrow
v	4	Drive	7	6	40.0MHz	Wide	L	0n	40.0MHz	Narrow
	5	Drive	7	6	40.0MHz	Wide	L	0n	40.0MHz	Narrow
	6	Host	112	NA	1 GHz	Serial	F	NA		
	7	Host	NA	113	1 GHz	Serial	F	NA		

Arrow Keys:Move Cursor |Enter:Select |Esc:Exit |Ctrl+L:Refresh Screen

Ch1	Mode (Host / Drive)	Primary Controller SCSI ID(s)	Secondary Controller SCSI ID(s)	Default Sync Clock	Default Wide	Terminator Diff/Enable/Disable/	Current Sync Clock	Current Width

Parity Check	View Channel Host-ID/WWN	View Device Port Name List (WWPN)

13.6 View and Edit Configuration Parameters

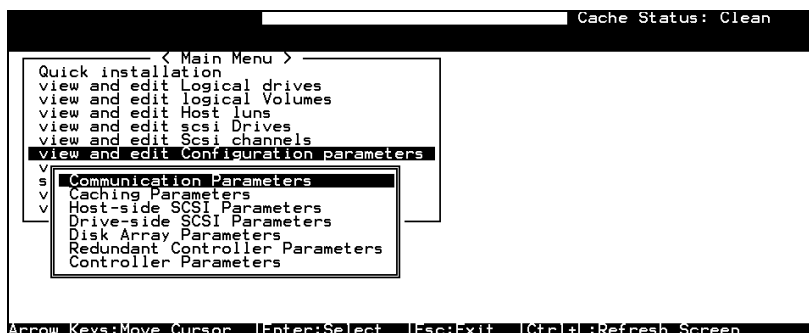

Communication Parameters

RS-232 Port Configuration

COM 1 (RS-232 Port)

Baud Rate	<input type="checkbox"/> 2400 <input type="checkbox"/> 4800 <input type="checkbox"/> 9600 <input type="checkbox"/> 19200 <input type="checkbox"/> 38400
Data Routing	<input type="checkbox"/> Direct to Port <input type="checkbox"/> Through Network
Terminal Emulation	<input type="checkbox"/> Enabled <input type="checkbox"/> Disabled

COM 2 (Redundant Controller Port)

Baud Rate	<input type="checkbox"/> 2400 <input type="checkbox"/> 4800 <input type="checkbox"/> 9600 <input type="checkbox"/> 19200 <input type="checkbox"/> 38400
Data Routing	<input type="checkbox"/> Direct to Port <input type="checkbox"/> Through Network
Terminal Emulation	<input type="checkbox"/> Enabled <input type="checkbox"/> Disabled

Ethernet Configuration

IP address	_____
NetMask	_____
Gateway	_____

PPP Configuration

PPP Access Name	_____
PPP Access Password	_____

Modem Operation → Modem Setup

Configure Modem Port	<input type="checkbox"/> Modem Port Not Configured <input type="checkbox"/> COM1 <input type="checkbox"/> COM2
Modem Operation Mode	<input type="checkbox"/> None (Default Used) <input type="checkbox"/> Replace Default <input type="checkbox"/> Append to Default
Modem Initialization - Custom Init. Command	AT
Dial-out Command	AT
Auto Dial-out on Initialization	<input type="checkbox"/> Enabled <input type="checkbox"/> Disabled
Dial-out Timeout	_____ Seconds
Dial-out Retry Count	Retry _____ Times
Dial-out Retry Interval	_____ Minutes
Dial-out on Event Condition	<input type="checkbox"/> Disabled <input type="checkbox"/> Critical Events Only <input type="checkbox"/> Critical Events and Warnings <input type="checkbox"/> All Events, Warnings and Notifications

Caching Parameters

Write-back Cache	<input type="checkbox"/> Enabled <input type="checkbox"/> Disabled
Optimization for	<input type="checkbox"/> Random I/O <input type="checkbox"/> Sequential I/O

Host Side SCSI Parameters

Maximum Queued I/O Count	<input type="checkbox"/> Auto _____
LUNs per Host SCSI ID	<input type="checkbox"/> LUNs
Number of Tags Reserved for each Host-LUN connection	_____
Peripheral Device Type Parameters	Peripheral Device Type - Device Qualifier - Removable Media - LUN Applicability -
Host Cylinder/Head/Sector Mapping configuration	Cylinder - Head - Sector -
Fibre Connection Options	_____

Drive Side SCSI Parameters

SCSI Motor Spin-up	<input type="checkbox"/> Enabled <input type="checkbox"/> Disabled
SCSI Reset at Power Up	<input type="checkbox"/> Enabled <input type="checkbox"/> Disabled
Disk Access Delay Time	<input type="checkbox"/> No Delay _____ Seconds
SCSI I/O Timeout	<input type="checkbox"/> Default _____
Maximum Tag Count	<input type="checkbox"/> Disabled _____
Periodic Drive Check Time	<input type="checkbox"/> Disabled _____

Periodic SAF-TE and SES Device Check Time	<input type="checkbox"/> Disabled _____
Periodic Auto-Detect Failure Drive Swap Check Time	<input type="checkbox"/> Disabled _____
Drive Predictable Failure Mode	<input type="checkbox"/> Disabled <input type="checkbox"/> Detect Only <input type="checkbox"/> Detect and Perpetual Clone <input type="checkbox"/> Detect and Clone + Replace
Fibre Channel Dual Loop	<input type="checkbox"/> Enabled <input type="checkbox"/> Disabled

Disk Array Parameters

Rebuild Priority	<input type="checkbox"/> Low <input type="checkbox"/> Normal <input type="checkbox"/> Improved <input type="checkbox"/> High
Verifications on Writes	
Verifications on LD Initialization Writes	<input type="checkbox"/> Enabled <input type="checkbox"/> Disabled
Verifications on LD Rebuild Writes	<input type="checkbox"/> Enabled <input type="checkbox"/> Disabled
Verifications on Normal Drive Writes	<input type="checkbox"/> Enabled <input type="checkbox"/> Disabled

Redundant Controller Parameters

Redundant Controller Communication Channel	_____
Secondary Controller RS-232	<input type="checkbox"/> Enabled <input type="checkbox"/> Disabled
Cache Synchronization on Write-through	<input type="checkbox"/> Enabled <input type="checkbox"/> Disabled

Controller Parameters

Controller Name	<input type="checkbox"/> Not Set _____
LCD Tile Display	<input type="checkbox"/> Controller Logo <input type="checkbox"/> Controller Name
Password Validation Timeout	<input type="checkbox"/> Disabled <input type="checkbox"/> 1 minute <input type="checkbox"/> 2 minutes <input type="checkbox"/> 5 minutes <input type="checkbox"/> Always Check
Controller Unique Identifier	_____
SDRAM ECC	<input type="checkbox"/> Enabled <input type="checkbox"/> Disabled

13.7 View and Edit Peripheral Devices

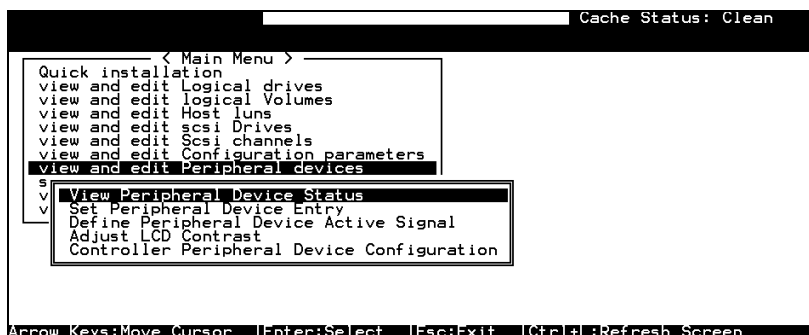

Set Peripheral Device Entry

Redundant Controller	<input type="checkbox"/> Enabled <input type="checkbox"/> Disabled
Power Supply Status	<input type="checkbox"/> Enabled <input type="checkbox"/> Disabled
Fan Status	<input type="checkbox"/> Enabled <input type="checkbox"/> Disabled
Temperature Status	<input type="checkbox"/> Enabled <input type="checkbox"/> Disabled
UPS Status	<input type="checkbox"/> Enabled <input type="checkbox"/> Disabled

Event Trigger Options

Controller Failure	<input type="checkbox"/> Enabled <input type="checkbox"/> Disabled
BBU Low/Failed	<input type="checkbox"/> Enabled <input type="checkbox"/> Disabled
UPS AC Power Loss	<input type="checkbox"/> Enabled <input type="checkbox"/> Disabled
Power Supply Failed	<input type="checkbox"/> Enabled <input type="checkbox"/> Disabled
Fan Failed	<input type="checkbox"/> Enabled <input type="checkbox"/> Disabled
Temperature Exceeds Limits	<input type="checkbox"/> Enabled <input type="checkbox"/> Disabled

Define Peripheral Device Active Signal

Power Supply Fail Signal	<input type="checkbox"/> Active High <input type="checkbox"/> Active Low
Fan Fail Signal	<input type="checkbox"/> Active High <input type="checkbox"/> Active Low
Temperature Alert Signal	<input type="checkbox"/> Active High <input type="checkbox"/> Active Low
UPS Power Fail Signal	<input type="checkbox"/> Active High <input type="checkbox"/> Active Low
Drive Failure Outputs	<input type="checkbox"/> Active High <input type="checkbox"/> Active Low

View System Information

Total Cache Size	<input type="checkbox"/> SDRAM _____ MB
Firmware Version	
Bootrecord Version	
Serial Number	

Battery Backup	<input type="checkbox"/> On	<input type="checkbox"/> Off
----------------	-----------------------------	------------------------------

Event Threshold Parameters

Thresholds for +3.3V	Upper _____	Lower _____
Thresholds for +5V	Upper _____	Lower _____
Thresholds for +12V	Upper _____	Lower _____
Thresholds for CPU temperature	Upper _____	Lower _____
Thresholds for Board Temperature	Upper _____	Lower _____

13.8 Save NVRAM to Disk, Restore from Disk

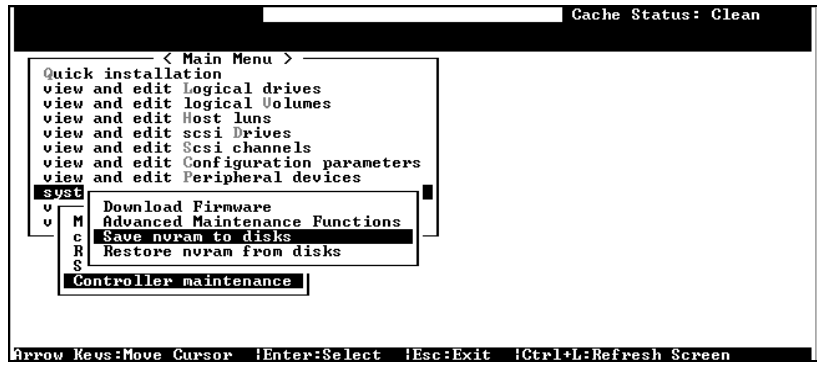

Update Firmware	Date	Save NVRAM to Disk or File	Date/Location	Restore NVRAM from Disk	Date

13.9 RAID Security: Password

Cache Status: Clean	
< Main Menu >	
Quick installation	
view and edit Logical drives	
view and edit logical Volumes	
view and edit Host luns	
view and edit scsi Drives	
view and edit Scsi channels	
view and edit Configuration parameters	
view and edit Peripheral devices	
System Functions	
v	Mute beeper
v	change Password
R	
S	
C	New Password: _
Enter:Confirm Esc:Exit Ctrl+L:Refresh Screen	

RAID Security

Controller Name	Password _____
-----------------	----------------

Array Expansion

The array expansion functions allow you to expand storage capacity without the cost of buying new equipment. Expansion can be completed on-line while the system is serving host I/Os.

This chapter is organized as follows:

14.1 Overview: Notes on using the expansion functions

14.2 Mode 1 Expansion: Theory and configuration procedure: expansion by adding drives

14.3 Mode 2 Expansion: Theory and configuration procedure for expansion by copying and replacing drives

14.4 Making Use of the Added Capacity: Expand Logical Drive Configuration procedure of the Expand function for a logical drive

14.5 Expand Logical Volume: Configuration procedure for the Expand function for a logical volume

14.6 Configuration Example: Volume
Extension in Windows 2000®

14.1 Overview

What is RAID Expansion and how does it work?

Before the invention of RAID Expansion, increasing the capacity of a RAID system meant backing up all data in the disk array, re-creating the disk array configuration with new drives, and then restoring data back into system.

Infortrend's RAID Expansion technology allows users to expand a logical drive by adding new drives, or replacing drive members with drives of larger capacity. Replacing is done by copying data from the original members onto larger drives; the smaller drives can then be replaced without powering down the system.

Notes on Expansion

1. Added Capacity:

When a new drive is added to an existing logical drive, the capacity brought by the new drive appears as a new partition. For example, if you have 4 physical drives (36GB each) in a logical drive, and each drive's maximum capacity is used, the capacity of the logical drive will be 108GB. (One drive's capacity is used for parity, e.g., RAID 3). When a new 36GB drive is added, the capacity will be increased to 144GB in two separate partitions (one is 108GB and the other 36GB).

2. Size of the New Drive:

A drive used for adding capacity should have the same or more capacity as other drives in the array.

3. Applicable Arrays:

Expansion can only be performed on RAID 0, 3, and 5 logical drives. Expansion cannot be performed on logical configurations that do not have parity, e.g., NRAID or RAID 1.

NOTE:

- Expansion on RAID0 is not recommended, because the RAID0 array has no redundancy. Interruptions during the expansion process may cause unrecoverable data loss.
-

4. Interruption to the Process:

Expansion should not be canceled or interrupted once begun. A manual restart should be conducted after the occurrence of a power failure or interruption of any kind.

Expand Logical Drive: Re-striping

Figure 14 - 1 Logical Drive Expansion

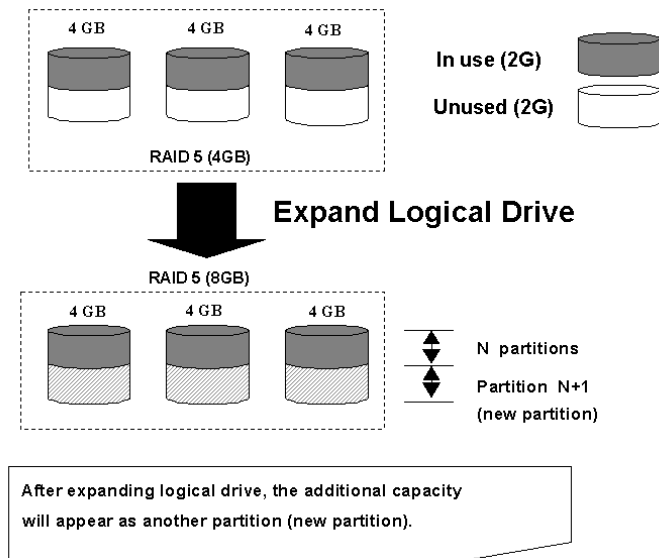

RAID levels supported: RAID 0, 3, and 5

Expansion can be performed on logical drives or logical volumes under the following conditions:

1. There is unused capacity in a logical unit
2. Capacity is increased by using member drives of larger capacity (see Copy and Replace in the discussion below)

Data is recalculated and distributed to drive members or members of a logical volume. Upon the completion of the process, the added or the previously unused capacity will become a new partition. The new partition must be made available through host LUN mapping in order for a host adapter to recognize its presence.

14.2 Mode 1 Expansion: Adding Drives to a Logical Drive

Use drives with the same capacity as the original drive members. Once completed, the added capacity will appear as another partition (new partition). Data is automatically re-striped across the new and old members during the add-drive process. See the diagram below to get a clear idea:

Figure 14 - 2 Expansion by Adding Drive

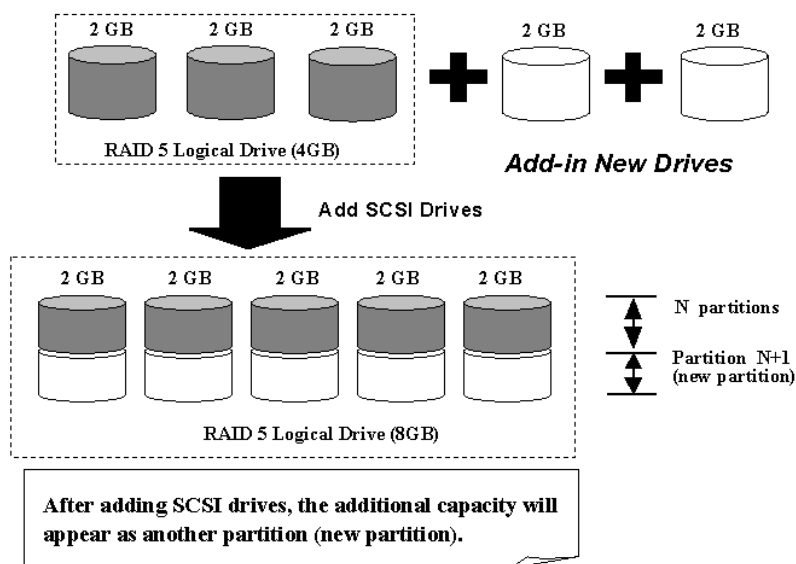

RAID levels supported: RAID 0, 3, and 5.

The new partition must be made available through a host ID/LUN.

Add Drive Procedure

First select from the Main Menu, “View and Edit Logical Drive,” and select a logical drive to add a new drive to. The drive selected for adding should have a capacity no less than the original member drives. If possible, use drives of the same capacity because all drives in the array are treated as though they have the capacity of the smallest member in the array.

Cache Status: Clean

Q	LG	ID	LV	RAID	Size(MB)	Status	0	#LN	#SB	#FL	NAME
V	P0	7559F508	NA	RAID5	1279	GOOD	R	5	0	0	
V	1			NONE							
V	2			NONE							
V	3			NONE							
V	4			NONE							
V	5			NONE							
V	6			NONE							
V	7			NONE							

Arrow Keys:Move Cursor |Enter:Select |Esc:Exit |Ctrl+L:Refresh Screen

Press [ENTER] to select a logical drive and choose "Add SCSI Drives" from the submenu. Proceed with confirming the selection.

Q	LG	ID	LV	RAID	Size(MB)	Status	0	#LN	#SB	#FL	NAME
V	P0	2E5B167A	NA	RAID5	9999	GOOD	R	3	0	0	
V	View scsi drives										
V	Delete logical drive										
V	Partition logical drive										
V	logical drive Name										
V	logical drive Assignments										
V	Expand logical drive										
V	Add Scsi drives										
V	c Add Drives to Logical Drive ?										
V	6 Yes No										
V	7			NONE							

Available drives will be listed. Select one or more drive(s) to add to the target logical drive by pressing [ENTER]. The selected drive will be indicated by an asterisk "*" mark.

Q	LG	ID	LV	RAID	Size(MB)	Status	0	#LN	#SB	#FL	NAME
V	P0	6D15A601	NA	RAID5	9999	GOOD	R	3	0	0	
V	View scsi drives										
V	Slot	Ch1	ID	Size(MB)	Speed	LG_DRV	Status	Vendor and Product ID			
V	*	1	0	4999	40MB	NONE	NEW DRV				
V		1	1	4999	40MB	NONE	NEW DRV				
V		1	2	4999	40MB	NONE	NEW DRV				
V	6		1	4	4999	40MB	NONE	NEW DRV			
V	7		1	8	4999	40MB	NONE	NEW DRV			

Press [ESC] to proceed and the notification will prompt.

Q	LG	ID	LV	RAID	Size(MB)	Status	0	#LN	#SB	#FL	NAME
V	P0	6D15A601	NA	RAID5	9999	GOOD	R	3	0	0	
V	Adding Notification										
V	[2189] LG:0 Logical Drive NOTICE: Starting Add SCSI Drive Operation										
V	4			NONE							
V	5			NONE							
V	6			NONE							
V	7			NONE							

Press [ESC] again to cancel the notification prompt; a status bar will indicate the percentage of progress.

Q	LG	ID	LV	RAID	Size(MB)	Status	0	#LN	#SB	#FL	NAME
v	20	258167A	INA	RAIDS	9999	GOOD	R	3	0	0	
v	1										
v	2										
v	3										
s	4			NONE							
v	5			NONE							
v	6			NONE							
v	7			NONE							

Upon completion, there will appear a confirming notification. The capacity of the added drive will appear as an unused partition.

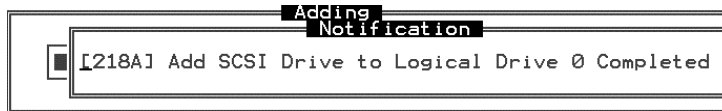

< Main Menu >		LUN	LV/LD	DRV	Partition	Size(MB)	RAID
Quick installation		0	LD	0	0	9999	RAIDS
view and edit Logical drives							
view and edit Logical Volumes							
view and edit Host Luns							

Q	LG	ID	LV	RAID	Size(MB)	Status	0	#LN	#SB	#FL	NAME
v	20	3445522	INA	RAIDS	14998	GOOD	S	4	0	0	
v	1										
v	2										
s	3										
v	4										
v	5										
v	6										
v	7										

view a	Partition	Offset(MB)	Size(MB)
	0	0	9999
	1	9999	4999

The added capacity will be automatically included, meaning that you do not have to "expand logical drive" later. Map the added capacity to another host ID/LUN to make use of it.

As diagrammed above, in "View and Edit Host LUN," the original capacity is 9999MB, its host LUN mapping remains unchanged, and the added capacity appears as the second partition.

IMPORTANT!

- Expansion by adding drives can not be canceled once started. If power failure occurs, the expansion will be paused and the controller will NOT restart the expansion when power comes back on. Resumption of the RAID expansion must be performed manually.
- If a member drive of the logical drive fails during RAID expansion, the expansion will be paused. The expansion will resume after the logical drive rebuild is completed.

14.3 Mode 2 Expansion:

Copy and Replace Drives with Drives of Larger Capacity

You may also expand your logical drives by copying and replacing all member drives with drives of higher capacity. Please refer to the diagram below for a better understanding. The existing data in the array is copied onto the new drives, and then the original members can be removed.

When all the member drives have been replaced, execute the "Expand Logical Drives" function to make use of the added capacity.

Figure 14 - 3 Expansion by Copy & Replace

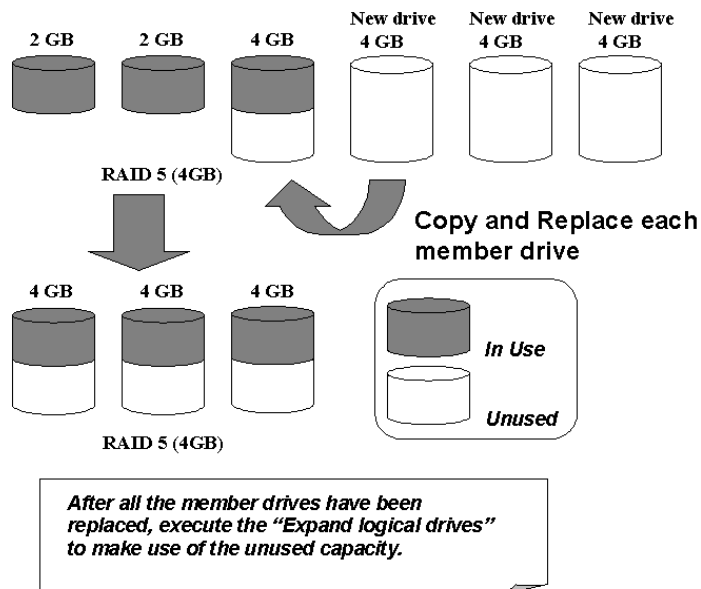

RAID levels supported: RAID 0, 3, and 5

Copy and Replace Procedure

Select from Main Menu "View and Edit Logical Drives." Select a target array, press [ENTER] and scroll down to choose "Copy and Replace Drive." Press [ENTER] to proceed.

Q	LG	ID	LV	RAID	Size(MB)	Status	0	#LN	#SB	#FL	NAME
V	P0	6D-15A60	NA	RAID5	9999	GOOD	R	4	0	0	
V	1										
V	2										
V	3										
V	4			NONE							
V	5			NONE							
V	6			NONE							
V	7			NONE							

Completion of the Copy and Replace process will be indicated by a notification message. Follow the same method to copy and replace every member drive. You may now perform "Expand Logical Drive" to make use of the added capacity, and then map the additional capacity to a host LUN.

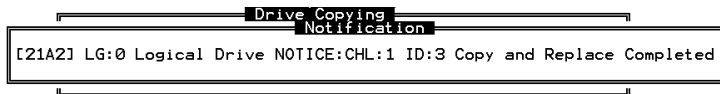

14.4 Making Use of the Added Capacity: Expand Logical Drive

In the following example, the logical drive is originally composed of three member drives and each member drive has the capacity of 1GB. "Copy and Replace" has been performed on the logical drive and each of its member drives has been replaced by a new drive with the capacity of 2GB. The next step is to perform "Expand Logical Drive" to utilize the additional capacity brought by the new drives.

1. Select "View and Edit Logical Drives" from the Main Menu and select the logical drive with its members copied and replaced.
2. Select "Expand Logical Drive" in the sub-menu and press [ENTER] to proceed. A confirming box will appear.
3. Proceed by pressing [ENTER] or entering any value no larger than the "maximum drive expand capacity" and press [ENTER].

14.5 Expand Logical Volume

To expand a logical volume, expand its logical drive member(s) and then perform "expand logical volume."

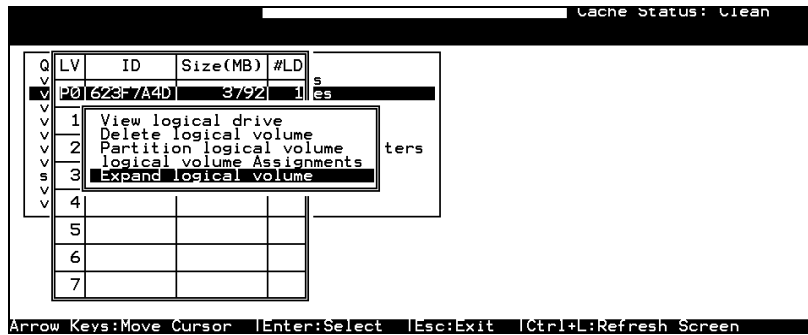

When prompted by "Expand Logical Volume?", choose **Yes** to confirm and the process will be completed immediately.

14.6 Configuration Example: Volume Extension in Windows 2000®

Limitations When Using Windows 2000

1. This limitations apply only to the Windows NT Server or Windows 2000 Server Disk Management which includes the Extend Volume Set function; Windows NT Workstation does not support this feature. The Volume Set Expansion formats the new area without affecting existing files on the original volume.
2. The system drive (boot drive) of a Windows NT/2000 system cannot be expanded.
3. The drive to be expanded should be using the NTFS file system.

Example

The following example demonstrates the expansion of a 16988MB RAID 5 logical drive. The HyperTerminal emulation software that comes with Windows Server is used to connect to the RAID controller via RS-232C.

LG	ID	LU	RAID	Size<MB>	Status	1	2	3	0	C	#LN	#SB	#FL	NAME
P0	2092804D	NA	RAID5	16988	GOOD				2	B	3	0	0	
1			NONE											
2			NONE											
3			NONE											
4			NONE											
5			NONE											
6			NONE											
7			NONE											

Arrow Keys:Move Cursor |Enter:Select |Esc:Exit |Ctrl+L:Refresh Screen

You can view information about this drive in the Windows 2000 Server's Computer Management -> Storage -> Disk Management.

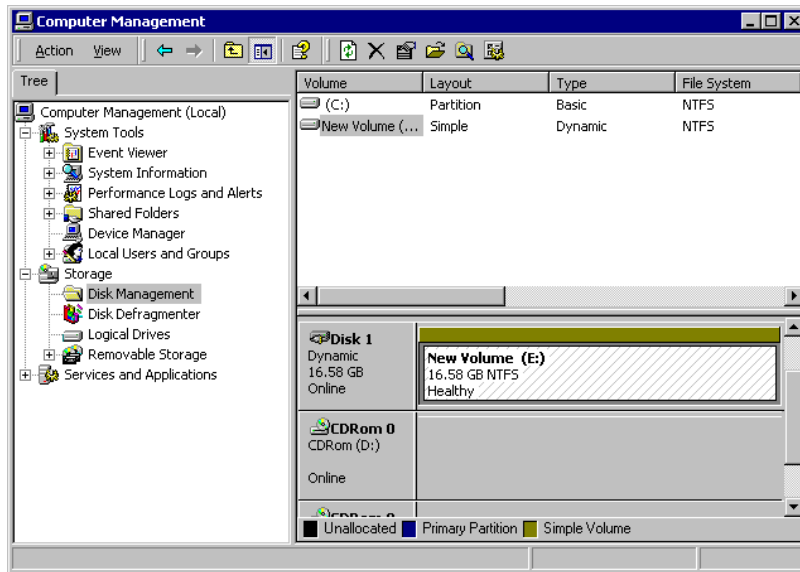

Place the cursor on Disk 1, right-click your mouse, and select "Properties." You will see that the total capacity for the Drive E: is about 16.5GB.

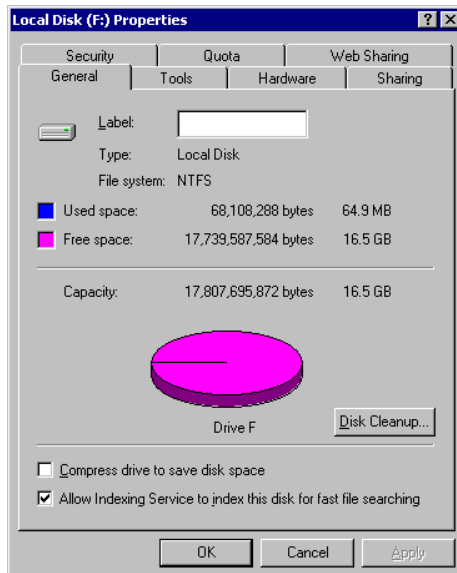

Follow the steps described in the previous section to "add" or "copy & replace" SCSI disk drives and perform "Logical Drive Expansion."

Mon Jan 20 18:30:48 2003 Cache Status: Clean
A0:92%

LG	ID	LU	RAID	Size<MB>	Status	1	2	3	0	C	#LN	#SB	#FL	NAME
P0	2092804D	NA	RAIDS	16988	GOOD				7	B	3	0	0	
1					Adding									
2					-----									
3					92% Completed_									
4			NONE											
5			NONE											
6			NONE											
7			NONE											

Arrow Keys:Move Cursor !Enter:Select !Esc:Exit !Ctrl+L:Refresh Screen

The 16.5GB logical drive has become a 25GB logical drive. Place the cursor on that logical drive, and then press [ENTER].

Mon Jan 20 18:32:34 2003 Cache Status: Clean

LG	ID	LU	RAID	Size<MB>	Status	1	2	3	0	C	#LN	#SB	#FL	NAME
P0	2092804D	NA	RAIDS	25482	GOOD				7	B	4	0	0	
1			NONE											
2			NONE											
3			NONE											
4			NONE											
5			NONE											
6			NONE											
7			NONE											

Arrow Keys:Move Cursor !Enter:Select !Esc:Exit !Ctrl+L:Refresh Screen

From the menu, select "Partition Logical Drive." You will see that the 25GB logical drive is composed of a 17GB partition and an 8.4GB partition.

Mon Jan 20 18:33:39 2003 Cache Status: Clean

LG	ID	LU	RAID	Size<MB>	Partition	Offset<MB>	Size<MB>	NAME
P0	2092804D	NA	RAIDS	25482	0	0	16988	
1			NONE		1	16988	8494	
2			NONE		2			
3			NONE		3			
4			NONE		4			
5			NONE		5			
6			NONE		6			
7			NONE		7			

Arrow Keys:Move Cursor !Enter:Select !Esc:Exit !Ctrl+L:Refresh Screen

Follow the directions in *Chapter 5* and *Chapter 7* to map the new partition to a host LUN. The new partition must be "mapped" to a host LUN in order for the HBA (host-bus adapter) to see it. Once you have mapped the partition, reboot your Windows server. The HBA should be able to detect an additional disk during the initialization process.

Return to Windows 2000 Server's Disk Management. There now exists a Disk 2 with 8.3GB of free space. You may use the "rescan disks" command to bring up the new drive.

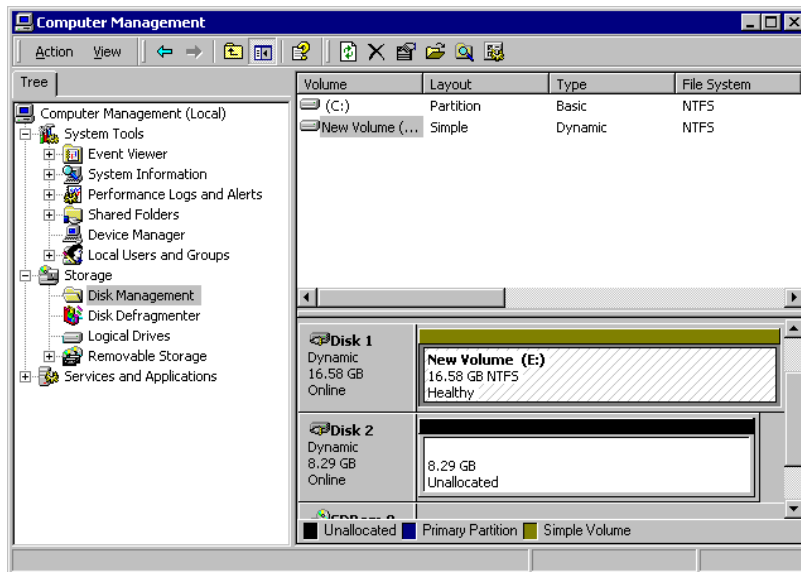

Select an existing volume (Disk1) and then right-click on the disk column. Select "Extend Volume" to proceed.

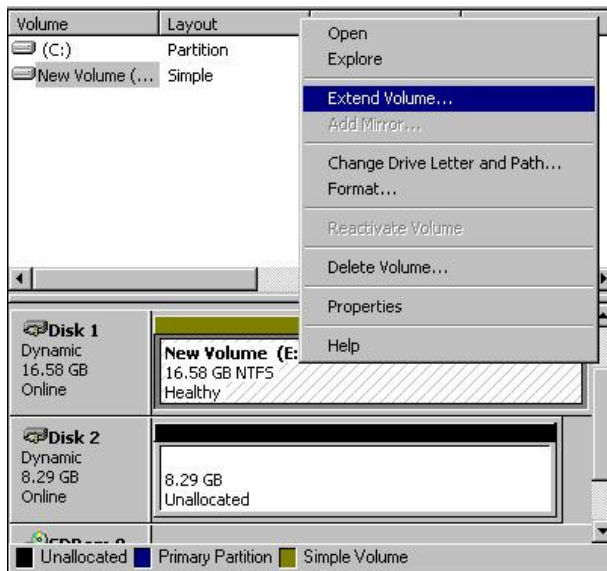

The Extend Volume Wizard will guide you through the rest of the process.

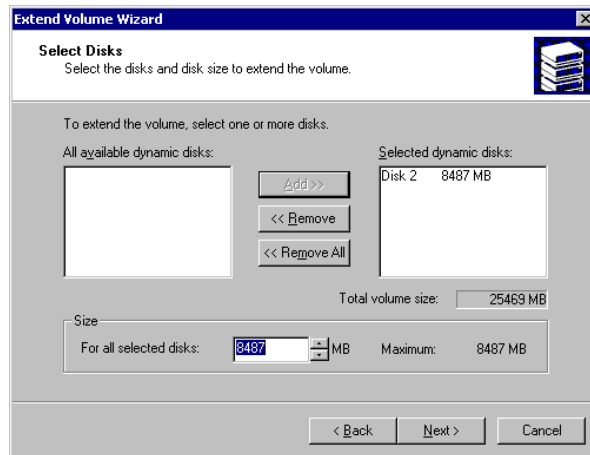

The screen will display that the volume set of Drive E: has been extended into a spanned volume by the 8.3GB in Disk2.

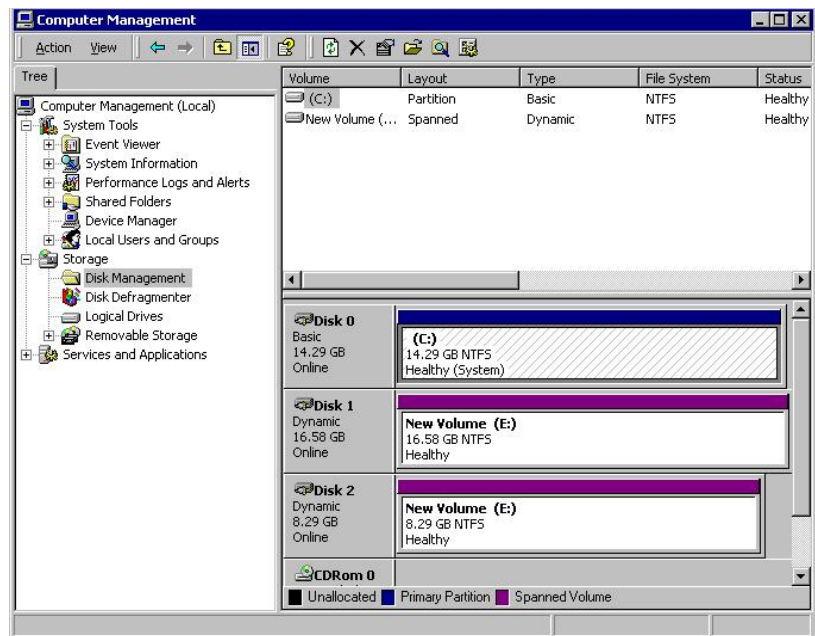

Logical Drive E: is now composed of two partitions with a total volume of 2500MB. To see this, hold down on the <Ctrl> key and select both Disk 1 and Disk2; then right-click your mouse and select "Properties."

Drive E: now has a capacity of about 25GB.

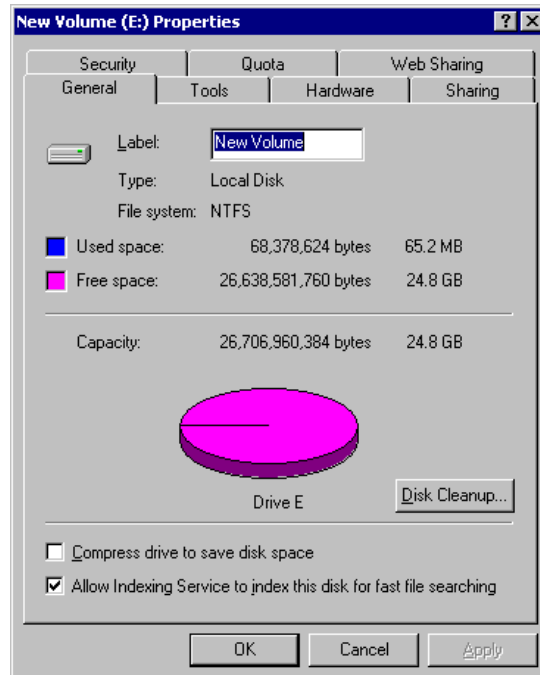

15.1 Overview

S.M.A.R.T.

With the maturity of technologies like S.M.A.R.T., drive failures can be predicted to certain degree. Before S.M.A.R.T., receiving notifications of drive bad block reassignments may be the most common omen that a drive is about to fail. In addition to the S.M.A.R.T.-related functions as will be discussed later, a system administrator can also choose to manually perform “Clone Failing Drive” on a drive which is about to fail.

This function provides system administrators a choice on when and how to preserve data from a failing drive. Although not necessary under normal conditions, you may also replace any drive at-will even when the source drive is healthy.

The “Clone Failing Drive” can be performed under the following conditions:

1. Replacing a failing drive either detected by S.M.A.R.T. or notified by the controller.
2. Manually replacing and cloning any drive with a new drive.

15.1.1 Clone Failing Drive

Unlike the similar functions combined with S.M.A.R.T., the “Clone Failing Drive” is a manual function. There are two options for cloning a failing drive: “Replace after Clone” and “Perpetual Clone.”

Replace after Clone

Data on the source drive, the drive with predicted errors (or any selected member drive), will be cloned to a standby spare and replaced later by the spare. The status of the replaced drive, the original member drive with predicted errors, will be redefined as a “used drive.” System administrators may replace the “used drive” with a new one, and then configure the new drive as a standby drive.

Locate the logical drive to which the drive with predictable errors belongs. Select the “Clone Failing Drive” function.

Select “Replace After Clone.” The controller will automatically start the cloning process using the existing “stand-by” (dedicated/global spare drive) to clone the source drive (the target member drive with predicted errors). If there is no standby drive (local/global spare drive), you need to add a new drive and configure it as a standby drive.

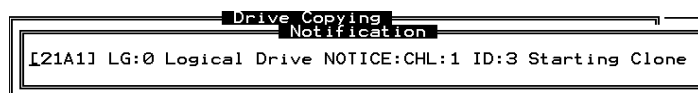
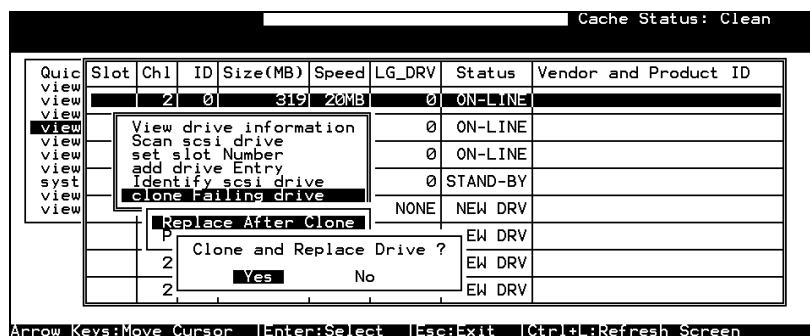

The cloning process will begin with a notification message. Press [ESC] to proceed.

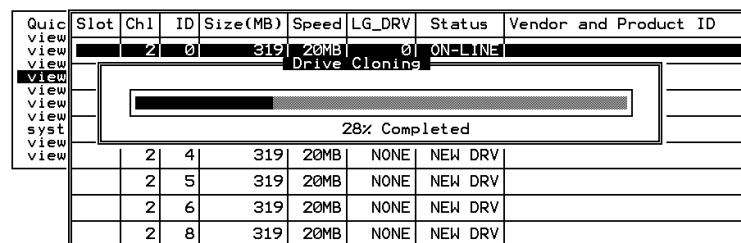

The cloning process will be indicated by a status bar.

You may quit the status bar by pressing [ESC] to return to the table of the connected drives. Select the drive indicated as “CLONING” by pressing [ENTER].

Slot	Chl	ID	Size(MB)	Speed	LG_DRV	Status	Vendor and Product ID
	2	0	319	20MB	0	ON-LINE	
	2	1	319	20MB	0	ON-LINE	
	2	2	319	20MB	0	ON-LINE	
	2	3	319	20MB	0	CLONING	
V	Source Drive: Channel 2 ID 0						EW DRV
s	View clone progress						EW DRV
a	Abort clone						EW DRV
I	Clone Failing Drive						NONE NEW DRV

Select "Clone Failing Drive" again to view the current status. You may identify the source drive and choose to "View Clone Progress," or "Abort Clone" if you happen to have selected the wrong drive.

When the process is completed, you will be notified by the following message.

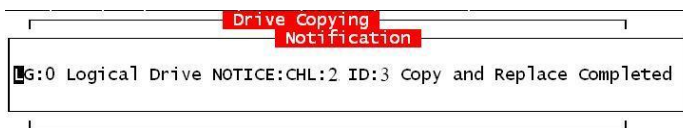

Perpetual Clone:

The standby spare will clone the source drive, the member drive with predicted errors or any selected drive, without substituting it. The status of the spare drive will be displayed as "clone drive" after the cloning process. The source drive will remain a member of the logical drive. If the source drive fails, the clone drive can readily take its place in the array.

In "View and Edit SCSI Drives," locate the member drive that shows predicted errors. Select "Clone Failing Drive," and choose "Perpetual Clone."

Cache Status: Clean							
Slot	Chl	ID	Size(MB)	Speed	LG_DRV	Status	Vendor and Product ID
	2	0	319	20MB	0	ON-LINE	
view	View drive information						0 ON-LINE
view	Scan scsi drive						0 ON-LINE
view	set slot Number						NONE NEW DRV
view	add drive Entry						NONE NEW DRV
view	Identify scsi drive						NONE NEW DRV
view	Clone Failing Drive						NONE NEW DRV
	Replace After Clone						NONE NEW DRV
	Perpetual Clone						NONE NEW DRV
	2	Perpetual Clone Drive ?				NEW DRV	
	2	Yes				No	NEW DRV

Arrow Keys:Move Cursor |Enter:Select |Esc:Exit |Ctrl+L:Refresh Screen

The controller will automatically start the cloning process using the existing "stand-by" (local/global spare drive) to clone the source drive (the target member drive).

The cloning process will begin with a notification message:

Drive Copying Notification

LG:0 Logical Drive NOTICE:CHL:2 ID:0 Starting Clone

Press [ESC] to view the current progress:

Quick View	Slot	Chl	ID	Size(MB)	Speed	LG_DRV	Status	Vendor and Product ID
view		2	0	319	20MB	0	ON-LINE	
view		2	1	319	20MB	0	ON-LINE	
view		2	2	319	20MB	0	ON-LINE	
view		2	3	319	20MB	0	CLONE	
view		2	4	319	20MB	NONE	NEW DRV	
view		2	5	319	20MB	NONE	NEW DRV	
view		2	6	319	20MB	NONE	NEW DRV	
view		2	8	319	20MB	NONE	NEW DRV	

35% Completed

You may quit viewing the status bar by pressing [ESC] to return to the previous menu. Select the drive indicated as "CLONING" by pressing [ENTER]. Select "Clone Failing Drive" again to view the progress. You may identify the source drive and choose to "View Clone Progress" or "Abort Clone" if you happen to have selected the wrong drive.

Quick View	Slot	Chl	ID	Size(MB)	Speed	LG_DRV	Status	Vendor and Product ID
view		2	0	319	20MB	0	ON-LINE	
view		2	1	319	20MB	0	ON-LINE	
view		2	2	319	20MB	0	ON-LINE	
view		2	3	319	20MB	0	CLONE	
view		2	4	319	20MB	NONE	NEW DRV	
view		2	5	319	20MB	NONE	NEW DRV	
view		2	6	319	20MB	NONE	NEW DRV	
view		2	8	319	20MB	NONE	NEW DRV	

Source Drive: Channel 2 ID 0
 Replace original with clone
 Delete clone
 clone failing drive

The cloning progress will be completed by a notification message as displayed below:

Drive Copying Notification

LG:0 Logical Drive NOTICE:CHL:2 ID:0 Clone Completed

You may press [ESC] to clear the notification message to see the SCSI drives' status after the cloning process. The source drive (Channel 1 ID 5) remains as a member of logical drive "0," and the "stand-by" drive (Channel 1 ID 2, the dedicated/global spare drive) has become a "CLONE" drive.

Quick View	Slot	Chl	ID	Size(MB)	Speed	LG_DRV	Status	Vendor and Product ID
view		2	0	319	20MB	0	ON-LINE	
view		2	1	319	20MB	0	ON-LINE	
view		2	2	319	20MB	0	ON-LINE	
view		2	3	319	20MB	0	CLONE	
view		2	4	319	20MB	NONE	NEW DRV	
view		2	5	319	20MB	NONE	NEW DRV	
view		2	6	319	20MB	NONE	NEW DRV	
view		2	8	319	20MB	NONE	NEW DRV	

15.1.2 S.M.A.R.T. (Self-Monitoring, Analysis and Reporting Technology)

This section provides a brief introduction to S.M.A.R.T. as one way to predict drive failure and Infortrend's implementations with S.M.A.R.T. for preventing data loss caused by drive failure.

A. Introduction

Self-Monitoring, Analysis and Reporting Technology (S.M.A.R.T.) is an emerging technology that provides near-term failure prediction for disk drives. When S.M.A.R.T. is enabled, the drive monitors predetermined drive attributes that are susceptible to degradation over time.

If a failure is likely to occur, S.M.A.R.T. makes a status report available so that the host can prompt the user to backup data from the failing drive. However, not all failures can be predicted. S.M.A.R.T. predictions are limited to the attributes the drive can monitor which are selected by the device manufacturer based on the attribute's ability to contribute to predict degrading or fault conditions.

Although attributes are drive specific, a variety of typical characteristics can be identified:

- Head flying height
- Data throughput performance
- Spin-up time
- Re-allocated sector count
- Seek error rate
- Seek time performance
- Spin try recount
- Drive calibration retry count

Drives with reliability prediction capability only indicate whether the drive is "good" or "failing." In a SCSI environment, the failure decision occurs on the disk drive and the host notifies the user for action. The SCSI specification provides a sense bit to be flagged if the disk drive determines that a reliability issue exists. The system then alerts the user/system administrator.

B. Infortrend's Implementations with S.M.A.R.T.

Infortrend uses the ANSI-SCSI Informational Exception Control (IEC) document X3T10/94-190 standard.

There are four selections related to the S.M.A.R.T. functions in firmware:

Disabled

Disables S.M.A.R.T.-related functions

Detect Only:

When the S.M.A.R.T. function is enabled, the controller will send a command to enable all drives' S.M.A.R.T. function, if a drive predicts a problem, the controller will report the problem in an event log.

Detect and Perpetual Clone

When the S.M.A.R.T. function is enabled, the controller will send a command to enable all drives' S.M.A.R.T. function. If a drive predicts a problem, the controller will report the problem in an event log. The controller will clone the drive if a Dedicated/Global spare is available. The drive with predicted errors will not be taken off-line, and the clone drive will still act as a standby drive.

If the drive with predicted errors fails, the clone drive will take over immediately. If the problematic drive is still working and another drive in the same logical drive fails, the clone drive will resume the role of a standby spare and start to rebuild the failed drive immediately. This prevents a fatal drive error if yet another drive should fail.

Detect and Clone + Replace

The controller will enable all drives' S.M.A.R.T. function. If a drive predicts a problem, the controller will report the problem in the form of an event log. The controller will then clone the problematic drive to a standby spare and take the problematic drive offline as soon as the cloning process is completed.

NOTE:

- *If you are using drives of different brands in your RAID system, as long as they are ANSI-SCSI Informational Exception Control (IEC) document X3T10/94-190-compatible, there should not be any problems working with the controller/subsystem.*
-

15.2 Configuration Procedure

Enabling the S.M.A.R.T. Feature

Follow the procedure below to enable S.M.A.R.T. on all drives.

1. First, enable the “Periodic Drive Check Time” function. In \View and Edit Configuration Parameters\Drive-side SCSI Parameters\Periodic Drive Check Time, choose a time interval.

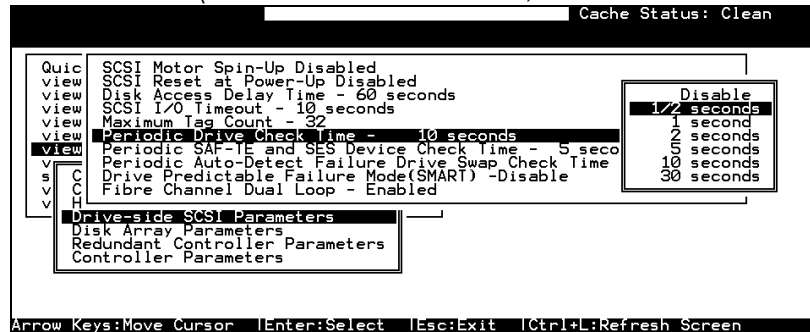

2. In \View and Edit Configuration Parameters\Drive-side SCSI Parameters\Drive Predictable Failure Mode <SMART>, choose one from “Detect Only,” “Detect, Perpetual Clone” and “Detect, Clone+Replace.”

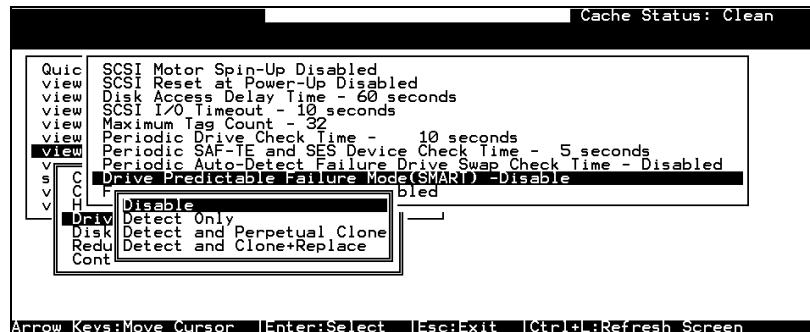

Examining Whether Your Drives Support S.M.A.R.T.

To see if your drive supports S.M.A.R.T., follow the steps below:

1. Enable "S.M.A.R.T." for your drives in the RAID system.
2. In "View and Edit SCSI Drives," choose one drive to test to. Press [ENTER] on the drive; a sub-menu will appear.
3. Note that a new item "Predictable Failure Test" appears in the sub-menu. If the S.M.A.R.T." feature is not properly enabled, this item will not appear in the sub-menu.

Cache Status: Clean

Slot	Chl	ID	Size(MB)	Speed	LG_DRV	Status	Vendor and Product ID
2	0	319	20MB	0	ON-LINE		
2	5	319	20MB	NONE	NEW DRV		
2	6	319	20MB	NONE	NEW DRV		
2	8	319	20MB	NONE	NEW DRV		

Sub-menu options:

- View drive information
- Scan scsi drive
- set slot Number
- add drive Entry
- Identify scsi drive
- Predictable failure test**

Arrow Keys:Move Cursor |Enter:Select |Esc:Exit |Ctrl+L:Refresh Screen

4. Choose "Predictable Failure Test,," The controller will force the drive to simulate predictable drive errors.

Test Drive Predictable Failure(SMART) ?

Yes No

Slot	Chl	ID	Size(MB)	Speed	LG_DRV	Status	Vendor and Product ID
2	0	319	20MB	0	ON-LINE		
2	8	319	20MB	NONE	NEW DRV		

5. Press [ENTER], and after a while (the next time the controller performs "Periodic Drive Check"), the controller will detect the errors simulated by the drive. An error message displays like this: "[1142] SMART-CH:? ID:? Predictable Failure Detected (TEST)." If this error message appears, it means your drive supports S.M.A.R.T. features.

Warning

[1115] CHL:2 ID:0 SCSI Drive ALERT: Unexpected Sense Received (526)

6. If the error message does not appear, you may simply refer to related documentation or contact your drive manufacturer for information about whether the drive model and drive firmware version support S.M.A.R.T.

NOTE:

As a precaution against the untimely failure of yet another drive, when configured as “perpetual clone,” the spare drive will only stay mirrored to the source drive (the drive with signs of failure), but not replace it until the source drive actually fails.

- 4d. While the spare drive is mirroring the source drive, any occurrence of drive failure (when there are no other spare drives) will force the spare drive to give up the mirrored data and resume its original role – it will become a spare drive again and start rebuilding the failed drive.

5. The “Detect, Clone + Replace” Function

- 5a. In \View and Edit Configuration Parameters\Drive-side SCSI Parameters\Drive Predictable Failure Mode <SMART>, choose “Detect, Clone+Replace.”
- 5b. Make sure you have at least one spare drive to the logical drive. (Either Local Spare Drive or Global Spare Drive)
- 5c. When a drive (a logical drive member) detects the predictable drive failure, the controller will “clone” the drive with a spare drive. After the “clone” process is completed, it will replace the source drive immediately. The source drive will be identified as a “used drive.”

If you want to see the progress of cloning, press [ESC] to clear the notification message and see the status bar.

The source drive’s status will be defined as a “used drive” and will be immediately replaced and pulled offline. This drive should be replaced with a new one as soon as possible.

Implementations for AV Applications

Maximum Drive Response Time

This option prepares the array for applications featuring “no drop-frame” operations and continuous reading such as video streaming. More options will be available for AV applications with future firmware releases.

In situations such as drive failure or the occurrence of bad blocks, a read returned after several hundreds milliseconds would prove too long and cause choppy audio or dropped video frames.

The maximum response time option, as displayed below, provides a timeout value for processing read requests. If timeout is reported on a specific member of an array, the subsystem immediately retrieves data from the parity data and other members of the array. In this way, causes of delay can be eliminated.

```

Sun Feb 17 23:01:36 2002                               Cache Status: Clean
                                                         BAT:++++
                                                         < Main Menu >
Quick installation
view and edit Logical drives
view and edit logical Volumes
view and edit Host luns
view and edit Drives
view and edit channels
view and edit Configuration parameters
V
S Communication Parameters
V Caching Parameters
V Host Parameters
  Driv Disable meters
  Disk 160 ms meters
  R    320 ms
  C    640 ms
  R    parity - Normal
  V    on Writes
  Max Drive Response Timeout - Disable
  
```

Arrow Keys:Move Cursor | Enter:Select | Esc:Exit | Ctrl+L:Refresh Screen

To prepare the array for read-intensive applications, the following are recommended:

1. Performance using the write-through caching mode is better than that using the write-back mode on subsystems equipped with redundant RAID controllers.

2. Arrays should not be partitioned.
3. The priorities for Rebuild or Add-drive operations should be set to “low.”
4. Another timeout value, the “Drive I/O Timeout” which determines whether a drive has eventually failed to respond to I/O requests, is required as the first-level timeout.

The maximum response time option comes available with an OEM append file. With the AV version of firmware, some of the internal settings are also adjusted:

1. Read requests have higher priority.
2. Firmware’s Smart Sorting algorithm is disabled to avoid latency that may arise due to sorting. Firmware is also forced to receive ordered read requests, the original receiving order from host.

A

Firmware Functionality Specifications

Basic RAID Management:

Specification	Feature
RAID levels	0, 1(0+1), 3, 5, 10, 30, and 50 (Multi-level RAID with the logical volume implementation)
Maximum number of logical drives	64 or 128 through OEM IAPPEND utility
Maximum logical drive capacity	64TB – when optimization mode is set to Sequential 16TB – when optimization mode is set to Random
RAID level dependency to each logical drive	Independent. Logical drive configured in different RAID levels can co-exist in a logical volume and in a RAID system
Maximum number of drives for each logical drive	128
Configurable stripe size	4KB, 16KB, 32KB, 64KB, 128KB, or 256KB per logical drive <ul style="list-style-type: none"> ▪ 128KB is the default for earlier firmware with optimization for Sequential I/Os ▪ 32KB is the default for earlier firmware with optimization for Random I/Os
Configurable Write Policy (write policy per array)	Write-Back or Write-Through per logical drive. This policy can be modified later.
Logical drive identification	Unique, controller randomly generated logical drive ID; Logical drive name user-configurable
Maximum number of partitions for each logical drive	128, through OEM “iappend.exe” program
Maximum number of logical drives in a logical volume	128 (64 with ATA RAID subsystem)
Maximum number of logical volumes	32 (16 with ATA RAID subsystem)
Maximum number of LUNs Mappable	Up to 1024
Maximum number of LUNs	Up to 32, user configurable

per host ID	
Concurrent I/O	Supported
Tag Command Queuing	Supported
Dedicated spare drive	Supported, hereby defined as the spare drive specifically assigned to a logical drive
Global spare drive	Supported, the spare drive serving all logical drives
Global spare auto-assign	Supported, applies to non-configured drive(s)
Co-existing dedicated and global spare drives	Supported
Auto-rebuild onto spare drive	Supported
Auto-scan of replacement drive upon manually initiated rebuild	Supported
One-step rebuild onto a replacement drive	Supported
Immediate logical drive availability	Supported; Logical arrays are immediately ready for Host I/Os. Initialization task is completed in the background except when the logical array is stated as "INCOMPLETE" or "BAD," e.g., has a failed member right after the creation.
Auto-rebuild onto failed drive replacement	Supported. With no spare drive, the controller will auto-scan the failed drive and starts rebuild automatically once the failed drive has been replaced.
Concurrent rebuild / expansion	Multiple logical drives can proceed with a Rebuild/Regenerating Parity, and/or Expansion/Initialization/Add Drive operation at the same time. Note: Regenerate Parity and Rebuild can not take place on a logical drive at the same time. Create, Expansion, and Add Drive operation can not take place on a logical drive at the same time.
Background firmware download	Firmware can be downloaded during active I/Os. Administrators may find appropriate time to reset controller later.
Auto recovery from logical drive failure (configuration on drives)	Supported. When user accidentally removed the wrong drive to cause the 2 nd drive failure of a one-drive-failed RAID5 / RAID3 logical drive, fatal error may occur. However, you may force the controller to reaccept the logical drive by switching off the controller, installing the drive back to its original drive slot, and then power on the controller. The logical drive will be restored to the one-drive-failed status.

Advanced Features:

Media Scan	<p>Supported. Verify written data on drives to avoid bad blocks from causing data inconsistency. If bad blocks are found, data can be reconstructed by comparing and recalculating parity from adjacent drives (RAID1/3/5).</p> <p>The “Reconstruction Writes” are followed by “Write Verification” operation.</p>
Bad block handling in degraded mode	<p>A method for handling low quality drives. The operation is performed on both the logical drive in degraded mode or that being rebuilt. If bad blocks should be encountered during Rebuild, Add Drive, Host Write, or Regenerate Parity operation, the controller will first attempt to reconstruct affected data and those unrecoverable bad blocks are stated as bad and passed to host.</p> <p>Low quality drive handling comes with transparent resetting of hung hard drives.</p>
Transparent reset of hung HDDs	Supported
Auto cache flush on critical conditions (caching mode dynamic switch)	<p>When critical conditions occur, e.g., component failure, or BBU under charge, cached data will be flushed and the write policy will be changed to write-through mode.</p> <p>Configurable “Trigger Events” for Write-through/Write-Back Dynamic Switch. The configuration can also be set with the “lappend” utility.</p>
Drive low-level format	Supported
Host-side Ordered Tag support	Supports write commands with Ordered Tags embedded
Drive identification (flash drive function)	Supported. Force the drive to light on the activity indicator for user to recognize the correct drive.
Drive information listing	Supported. Drive vendor name, model number, firmware revision, capacity (blocks), serial number, narrow/wide and current sync. speed.
Drive read/write testing	Supported
Configuration on disks	Supported. The logical drive information is recorded on drive media. The logical drives can still be accessed if using different Infortrend RAID controllers/subsystems.
Save/ restore NVRAM to / from disks	Supported. Save all the settings stored in the controller NVRAM to the logical drive members
Save / restore NVRAM to / from a file	Supported. Save all the settings stored in the controller NVRAM to a file (via GUI manager) on user’s computer.
Host-side 64-bit LBA support	Supports array configuration (logical drive, logical volume, or a partition of them) of a capacity larger than 2TB.

Host LUN geometry: user configurable default geometry	<ol style="list-style-type: none"> 1. Capacity <64GB: Head=63, Sector=32, Cylinder=? (depends on capacity) 2. 64GB<capacity<128GB: Head=64, Sector=64, Cylinder=? (depends on capacity) 3. 128GB<capacity<256GB: Head=127, Sector=64, Cylinder=? (depends on capacity) 4. 256GB<capacity<512GB: Head=127, Sector=127, Cylinder=? 5. 512GB<capacity<1TB: Head=255, Sector=64, Cylinder=? (depends on capacity) 6. 1TB<capacity: Head=225, Sector=225, Cylinder=? (depends on capacity)
User configurable geometry range:	Sector: 32, 64, 127, 255 or Variable Head: 64, 127, 255 or Variable Cylinder: <1024, <32784, <65536 or Variable
Drive motor spin-up	Supported. The controller will send spin-up (start unit) command to each drive at the 4 sec. intervals.
Drive-side tag command queue	Supported. User adjustable up to 128 for each drive
Host-side maximum queued I/O count	User adjustable up to 1024
Maximum concurrent host LUN connection	User adjustable up to 64
Number of tags reserved for each Host-LUN connection	User adjustable up to 256
Controller shutdown	Flushes cached contents upon the detection of critical conditions.
Drive I/O timeout	User adjustable
IO channel diagnostics	Supported; please contact your dealer for more details
Maximum Drive Response Time	User adjustable from 160 to 640ms. If a disk drive fails to return data on read requests before the timeout value is exceeded, the array immediately generates data from the parity data and the other members of a logical drive.
Drive roaming	Supported

Caching Operation:

Write-back cache	Supported.
Write-through cache	Supported.
Supported memory type	SDRAM memory for enhanced performance Fast Page Memory with Parity for enhanced data security
Read-ahead operation	Intelligent Dynamic read-ahead operation for sequential data accessing
Multi-threaded operation	Yes

Scatter / Gather	Supported		
I/O sorting	Supported. Optimized I/O sorting for enhanced performance		
Adaptive Write-back/Write-through switching	For a better performance when handling sequential writes, firmware temporarily disables write-cache and the synchronized cache operation between partner controllers. Restores write-back mode when later encountering random and small writes.		
Periodic Cache Flush	Firmware can be configured to flush the cached contents in memory at every preset interval if data integrity is of the concern, e.g., the lack of a battery backup protection.		
Variable stripe size		Opt. for Sequential I/O	Opt. For Random I/O
	RAID0	128	32
	RAID1	128	32
	RAID3	16	4
	RAID5	128	32
Caching Optimization	<ul style="list-style-type: none"> • Cache buffer sorting prior to cache flush operation • Gathering of writes during flush operation to minimize the number of I/Os required for parity update • Elevator sorting and gathering of drive I/Os • Multiple concurrent drive I/Os (tagged commands) • Intelligent, predictive multi-threaded read-aheads • Multiple, concurrent host IO threads (host command queuing) 		

RAID Expansion:

On-line RAID expansion	Supported. Capacity brought by array expansion is immediately ready for Host I/Os when its status changes from "EXPAND" to "INITIALIZING." Initialization task is then completed in the background except when the logical array is stated as "INCOMPLETE" or "BAD;" e.g., has a failed member right after creation.
Mode-1 RAID expansion - add drive	Supported. Multiple drives can be added concurrently. Add Drive can even be performed in degraded mode.
Mode-2 RAID expansion – copy and replace drives	Supported. Replace members with drives of larger capacity.
Expand capacity with no extra drive bays required	Supported in Mode 2 RAID expansion, which provides "Copy and Replace Drive" function to replace drives with drives of greater capacity. No need to add another enclosure for the extra drives.
Operating system support for RAID expansion	No. No operating system driver required. No software has to be installed for this purpose.

Fibre Channel Support:

Channel mode	All channels configurable to Host or Drive mode, RCC or Drive+RCC, user configurable.
Redundant controller	Redundant using FC controllers supported.
Host-side loop failure detection	Supported. The LIPs on the host channels will not be displayed to users.
Drive-side loop failure detection	Supported.
Point-to-point topology	Supported.
Arbitrated loop topology	Supported.
Fabric topology	Supported.
Host redundant loop / dual-loop topology	Supported. (Also requires the host computer Fibre HBA driver support)
Drive side redundant loop load-sharing	Workloads can be automatically balanced between member loops for performance optimization.
Fibre channel ID	User selectable from ID 0 to 125.
Fibre channel CRC	Supported
Point-to-point and FC-AL protocol	User configurable.
LUN filtering (RAID-based mapping)	<p>Host LUN mapping with user-configurable Filter entry and Filter type (access control), up to 128 Filter entries can be appended to Host-ID/LUN combinations.</p> <ul style="list-style-type: none"> ▪ Host channel HBA WWN browsing: a list of WWNs from detected HBAs on the host channel will be provided for user's convenience when masking LUN Filtering. ▪ Bit-masking: Based on the user provided WWN of the host HBA (user can enter the WWN manually from a list browsed or that provided by the controller). Users can also assign a bit-masking to group a certain group of WWNs to be included in the LUN Filtering. ▪ Read/Write Privilege: Users can choose the following privilege for each LUN Filtering: Read/Write, Read Only, and No Access.
WWN table stored in NVRAM	Each WWN number can be assigned with a nick name for ease of identification
Issue LIP command	LIP manually evoked to bring in FC ports on a restored link
Sync. cache channel over Fibre loops	Supported, no extra cabling between two controllers; communications data can be distributed to one or two dedicated channels or over all drive loops.

S.M.A.R.T. Support:

Copy & replace drive	Supported. User can choose to clone a member drive before drive failure.
Drive S.M.A.R.T. support	Supported, with intelligent error handling implementations.
User selectable modes for S.M.A.R.T.	<ol style="list-style-type: none"> 1. Detect only 2. Perpetual Clone on detection of S.M.A.R.T. condition 3. Clone + Replace

Redundant Controller:

Active-active redundant controller	Supported
Synchronized cache	<p>Supported. Through single or redundant, dedicated synchronizing channels. Synchronized cache over Fibre loops is supported.</p> <p>Synchronized cache can be disabled when using write-through mode in redundant controllers to prevent performance trade-offs.</p>
Write-back cache enabled in redundant controller mode	Yes; with synchronized cache connection between controllers.
Automatic failover	Yes for all PowerPC controllers (user's interaction necessary)
Automatic failback	Yes for all PowerPC controllers (user's interaction necessary)
Fibre channel redundant controller	Supported.
Controller hot-swap	<ul style="list-style-type: none"> ▪ No need to shut down the failed controller before replacing the failed controller. (Customer's design-in hot-swap mechanism necessary) ▪ Support on-line hot-swap of the failed controller. There is no need to reset or shutdown the failed controller. One controller can be pulled out during active I/Os to simulate the destructive controller failure. (Customer's design-in hot-swap mechanism necessary)
Redundant controller communication channel	SCSI; RCC Reset signals built-in Fibre channel(s)
Parity synchronization in redundant controller write-back mode to avoid write-hole	Supported.

Redundant controller communication over Fibre loops	Dedicated loops or distribution over drive loops selectable
No single-point-of-failure	Supported.
Automatic engagement of replacement controller	Supported in PowerPC series
Dynamic cache memory allocation	Yes. Cache memory is dynamically allocated, not fixed.
Environment management	Supported. SAF-TE, S.E.S., ISEMS (I ² C interface); and on-board controller voltage/temp monitor are all supported in both single and redundant controller mode. In the event of controller failure, services can be taken over by the existing controller.
Cache battery backup	Supported. Battery backup solutions for cache memory are supported in both single controller and redundant modes.
Load sharing	Supported. Workload can be flexibly divided between different controllers by assigning logical configurations of drives (LDs/LVs) to different controllers.
User configurable channel mode	Supported. Channel modes configurable (SCSI or Fibre) as HOST or DRIVE in both single controller and redundant controller mode.
Require a special firmware for redundant controller?	No. All firmware and all Infortrend external RAID controllers support redundant controller function.
Redundant controller rolling firmware upgrade	Firmware upgrade can be downloaded to the primary controller and then be adopted by both controllers, without interrupting host I/Os.
Redundant controller firmware synchronization	In the event of controller failure, a replacement controller running a different version of firmware can be combined to restore a redundant system with a failed controller. Different firmware versions can be auto-synchronized later.

Data Safety:

Regenerate parity of logical drives	Supported. Can be performed by users to ensure that bad sectors do not cause data loss in the event of drive failure.
Scheduled Media Scan	Revision 3.34 allows Media Scan to be scheduled starting at a specified start time and repeated at regularly timed intervals. The start time and time intervals can be selected from drop-down menus. Start time is manually entered using its numeric representatives in the following order [MMDDhhmm[YYYY]], and it reads the date and time set for the controller's real-time clock. The selectable time intervals (the Execution Period) range

	<p>from one (1) second to seven (7) weeks.</p> <p>Each such schedule can be defined to operate on individual hard drives, all members of a specified logical drive, or members of selected logical drives. Each schedule can include up to five (5) logical drives. The RS-232C terminal and RAIDWatch revision 2.0 will support this functionality.</p>
Bad block auto-reassignment	Supported. Automatic reassignment of bad block
Battery backup for cache memory	Supported. The battery backup solutions provide long-lasting battery support to the cache memory when power failure occurs. The unwritten data in the cache memory can be committed to drive media when power is restored.
Verification on normal writes	Supported. Performs read-after-write during normal write processes to ensure data is properly written to drives.
Verification on rebuild writes	Supported. Performs read-after-write during rebuild write to ensure data is properly written to drives.
Verification on LD initialization writes	Supported. Performs read-after-write during logical drive initialization to ensure data is properly written to drives.
Drive S.M.A.R.T. support	Supported. Drive failure is predictable with reference to the variables detected. Reaction schemes are selectable from Detect only, Perpetual Clone and Copy + Replace. These options help to improve MTBF.
Clone failing drive	Users may choose to clone data from a failing drive to a backup drive manually
Automatic shutdown on over-temperature condition	Controller automatically starts a shutdown sequence upon the detection of high-ambient temperature for an extended period of time.

System Security:

Password protection	Supported. All settings require the correct password (if set) to ensure system security.
User-configurable password validation timeout	Supported. After certain time in absence of user interaction, the password will be requested again. This helps to avoid unauthorized operation when user is away.
SSL-enabled RAIDWatch Agents	Agents communicate to the controller through limited set of authorization options.

Environment Management:

SAF-TE/S.E.S. support	Supported. The SAF-TE/S.E.S. modules can be connected to the drive channel, the controller will detect errors from SAF-TE/S.E.S. devices or notify drive failure via SAF-TE/S.E.S.. <ul style="list-style-type: none"> • Both SAF-TE/S.E.S. via drive and device-self-interfaced are supported. • Redundant SAF-TE/S.E.S. devices are supported • Multiple S.E.S. devices are supported
Dynamic on-lining of enclosure services	Once an expansion unit (JBOD) with supported monitoring interface is combined with a RAID system, its status will be automatically polled.
SAF-TE/S.E.S. polling period	User configurable (50ms, 100ms, 200ms, 500ms, 1~60sec)
ISEMS (Infotrend Simple Enclosure Management Service)	Supported.
Multiple SAF-TE/S.E.S. modules on the same channel	Supported.
Multiple SAF-TE /S.E.S. modules on different channels	Supported.
Mapping SAF-TE/S.E.S. device to host channel for use with host-based SAF-TE/S.E.S. monitoring	Supported.
Dual-LED drive status indicators	Supported. Both single-LED and dual-LED drive status indicators are supported.
SAF-TE/ S.E.S. temperature value display	Supported. Display the temperature value provided by enclosure SAF-TE module (if available).
Fault-bus support	Provides the simplest implementation for the enclosure management. All fault-bus input/output signals are active-high/active-low user adjustable.
On-board controller voltage monitors	Supported. Monitors the 3.3V, 5V, and 12V voltage status. Event trigger threshold user configurable.
On-board controller temperature sensors	Supported. Monitors the CPU and board temperature status. Event trigger threshold user configurable.
Enclosure redundant power supply status monitoring	Supported. SAF-TE/S.E.S./ISEMS
Enclosure fan status monitoring	Supported. SAF-TE/S.E.S./ISEMS
Enclosure UPS status monitoring	Supported. SAF-TE/S.E.S./ISEMS
Enclosure temperature monitoring	Supported. SAF-TE/S.E.S./ISEMS

User Interface:

RAIDWatch on-board	Out-of-band configuration via LAN. Browser accessible configuration option by installing RAIDWatch to reserved space on drive via ftp.
RS-232C terminal	Supports terminal modes: ANSI, VT-100, ANSI Color. Provides menu-driven user-friendly text-based interface.
Graphical user interface (Java-based GUI manager)	Provides user-friendly graphical interface. Communicates with RAID controller via In-band SCSI, In-band Fibre or SNMP (Windows-based GUI).
SSH support	Secure Shell over Telnet supported
External interface API for customized host-based management	Supported.
LCD front panel	Provides easy access for user instinct operation.
Buzzer alarm	Warns user when any failure or critical event occurs.

High Availability:

Custom inquiry serial number	Custom Inquiry Serial Number (for support of multi-pathing software like Veritas, QLogic, etc)
Remote redundant controller configuration	Supported. Remote redundant controller configuration (support fully automatic failback)

JBOD-Specific:

Format	Restore controller-maintained defect list to default
Reassign blocks	Add entry to the defect list maintained by controller on disk drives
Write-verification	Writes followed by a verify
SMART	Sense data and mode parameters support
Special mode parameters	Error handling page – Enable/Disable retry Caching page – Enable/Disable Read/Write caching SMART enable parameters Geometry – saved on format command completion

B

System Functions: Upgrading Firmware

Upgrading Firmware

The RAID controller's firmware resides in flash memory that can be updated through the COM port, LAN port, or via In-band SCSI/Fibre. New releases of firmware are available in the form of a DOS file in the "pub" directory of Infortrend's FTP site or on a 3.5" diskette. The file available at the FTP site is usually a self-extracting file that contains the following:

- FW30Dxyz Firmware Binary (where "xyz" refers to the firmware version)
- B30Buvw Boot Record Binary (where "uvw" refers to the boot record version)
- README.TXT Read this file first before upgrading the firmware/boot record. It contains the most up-to-date information which is very important to the firmware upgrade and usage.

These files must be extracted from the compressed file and copied to a directory in boot drive.

New Features Supported with Firmware 3.21

Background RS-232C Firmware Download:

Host I/Os will not be interrupted during the download process. After the download process is completed, user should find a chance to reset the controller for the new firmware to take effect.

Redundant Controller Rolling Firmware Upgrade:

When download is performed on a dual-controller system, firmware is flashed onto both controllers without interrupting host I/Os. After the download process is completed, the Primary controller will reset and let the Secondary take over the service temporarily. When the Primary comes back on-line, the Secondary

will hand over the workload and then reset itself for the new firmware to take effect. The rolling upgrade is automatically performed by controller firmware and user's intervention is not necessary.

Redundant Controller Firmware Sync-version:

A controller used to replace a failed unit in a dual-controller system is often running a newer release of firmware version. To solve the contention, firmware running on the replacement controller will be downgraded to that running on the surviving controller.

IMPORTANT!

- *Allow the downloading process to finish. Do not reset or turn off the computer or the controller while it is downloading the file. Doing so may result in an unrecoverable error that requires the service of the manufacturer.*
- *While the firmware is new, the boot record that comes with it may be the same version as the one in the controller. If this is the case, there is no need to upgrade the Boot Record Binary.*

NOTE:

- *Controller serial port COM 2 can not be used to download firmware.*
-

Upgrading Firmware Using In-band SCSI + RAIDWatch Manager

Establish the In-band SCSI connection in RAIDWatch Manager

Please refer to RAIDWatch *User's Manual* for details on establishing the In-band SCSI connection for RAIDWatch Manager.

Upgrade Both Boot Record and Firmware Binaries

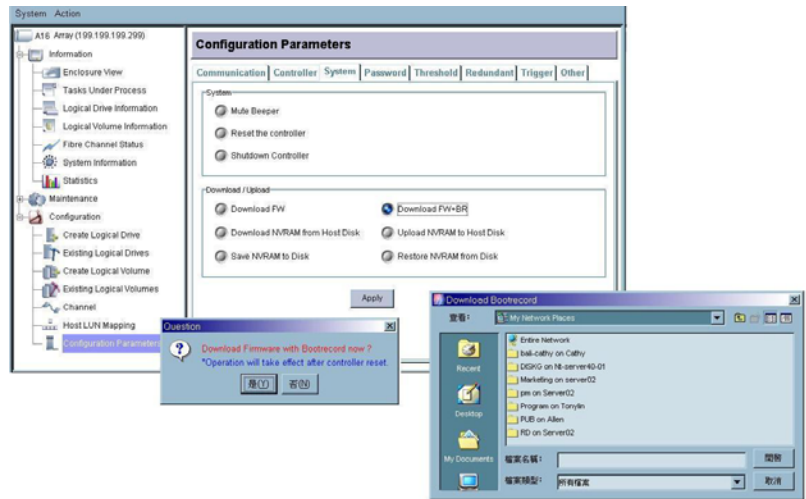

1. Connect to the RAID system locally or from a remote host using RAIDWatch Manager. While connected to the RAID system, there will be icon(s) with IP address specified on the left of the menu screen. Select by double-clicking the icon of the RAID system which firmware is to be upgraded. Select the "Configuration Parameters" icon and then select the "System" tab. Single-click the "Download FW+BR" check circle. Click the Apply button to proceed. A message prompt should display. Click Yes and then a file location prompt will appear.
2. Provide the boot record binary filename, the RAIDWatch Manager will start to download the boot record binary to the controller.
3. After the boot record download is completed, provide the firmware filename to the RAIDWatch Manager. It will start to download the firmware to the controller.
4. Shutdown the system or stop the application(s) which are accessing the RAID, then reset the controller in order to use the new downloaded firmware. **With firmware release 3.21 and above**, host I/Os will not be interrupted by the download process. Users may find a chance to stop host I/Os and reset the controller for new firmware to take effect.

Upgrade the Firmware Binary Only

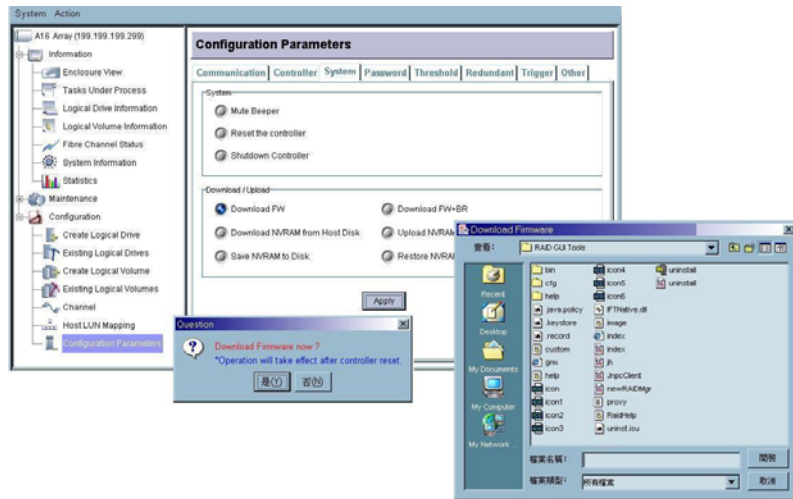

1. Connect to the RAID system locally or from a remote host using RAIDWatch Manager. While connected to the RAID system, there will be icon(s) with IP address specified on the left of the menu screen. Select by double-clicking the icon of the RAID system which firmware is to be upgraded. Select the "Configuration Parameters" icon and then select the "System" tab. Single-click the "Download FW" check circle. Click the Apply button to proceed. A message prompt should display. Click Yes and then a file location prompt will appear. .
2. Provide the firmware filename to the RAIDWatch Manager. It will start to download the firmware to the controller.
3. Shutdown the system or applications which are accessing the RAID, then reset the controller in order to use the new downloaded firmware.

Upgrading Firmware Using RS-232C Terminal Emulation

The firmware can be downloaded to the RAID controller by using an ANSI/VT-100 compatible terminal emulation program. Whichever terminal emulation program is used must support the ZMODEM file transfer protocol. The following example uses the HyperTerminal in Windows NT®. Other terminal emulation programs (e.g., Telix and PROCOMM Plus) can perform the firmware upgrade as well.

Establishing the connection for the RS-232C Terminal Emulation

Please refer to chapter 4, "Connecting to Terminal Emulation," and also your hardware manual for details on establishing the connection.

Upgrading Both Boot Record and Firmware Binaries

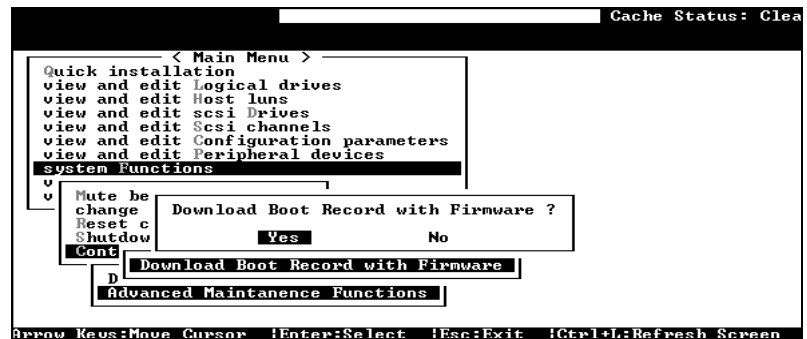

1. From the Main Menu, scroll down to "System Functions."
2. Go to "Controller Maintenance."
3. Choose "Advanced Maintenance."
4. Select "Download Boot Record and Firmware."
5. Set ZMODEM as the file transfer protocol of your terminal emulation software.
6. Send the Boot Record Binary to the controller. In HyperTerminal, go to the "Transfer" menu and choose "Send file." If you are not using Hyper Terminal, choose "Upload" or "Send" (depending on the software).
7. After the Boot Record has been downloaded, send the Firmware Binary to the controller. In HyperTerminal, go to the "Transfer" menu and choose "Send file." If you are not using Hyper Terminal, choose "Upload" or "Send" (depending on the software).
8. When the Firmware completes downloading, the controller will automatically reset itself.

Appendix

C

Event Messages

The controller events can be categorized as follows:

Alert	Errors that need to attend to immediately
Warning	Errors
Notification	Command processed message sent from Firmware

The RAID subsystem records all system events from power on, it can record up to 1,000 events. To power off or to reset the controller will cause an automatic deletion of all the recorded event logs.

The RAIDWatch manager can be used to record events on multiple subsystems especially when controller reset or power-off is an expected action. The events can also be seen from RAIDWatch's Configuration Client utility. Associated details can be found in the RAIDWatch user's manual and online help.

Descriptions below may contain abbreviations. Abbreviations and Capitalized letters are preserved for the coherency with the event messages shown on LCD screen or terminal.

Event Index

Controller Events

Alert:

Controller SDRAM ECC Multi-bits Error Detected
Controller SDRAM ECC Single-bit Error Detected
Controller SDRAM Parity Error Detected
Controller ALERT: Power Supply Unstable or NVRAM Failed
Controller ALERT: Redundant Controller Failure Detected
Controller BBU Absent or Failed!
Controller BBU Failure Detected!
Controller BBU Thermal Shutdown/Enter Sleep-Mode!
Controller PCI Bus Parity Error Detected
BBU Absent or Failed! Correct It and Reset Ctlr to Take Effect
Force Controller Write-Through on Trigger Cause
ALERT: Controller FAN 0 Low Speed Detected (XXX RPM)
ALERT: +_V Low Voltage Detected(._.V)

Warning:

Force Controller Write-Through on Trigger Cause
Controller BBU Not Fully Charged !
Memory Not Sufficient to Fully Support Current Config.

Notification:

Controller NOTICE: NVRAM Factory Defaults Restored
Controller NOTICE: Redundant Controller Firmware Updated
Memory is Now Sufficient to Fully Support Current Config.
Controller BBU is Charging !
NOTICE: Controller BBU Back On-Line !
NOTICE: Controller BBU Fully Charged !
NOTICE: Controller BBU Present !
NOTICE: Controller FAN _ Back On-Line(_ RPM)
Board_ Cold Temperature Back To Non-Critical Levels(_C)
+_V Upper Voltage Back within Acceptable Limits(_V)
+_V Lower Voltage Back within Acceptable Limits(_V)
Controller NOTICE: Redundant Controller Firmware Updated

Channel and Drive Error

Drive:

Alert:

CHL:_ ID:_ Drive ALERT: Aborted Command (B)
CHL:_ ID:_ Drive ALERT: Bad Block Encountered - 0 (10B)
CHL:_ ID:_ Drive ALERT: Block Reassignment Failed - 0 (10B)
CHL:_ ID:_ Drive ALERT: Block Successfully Reassigned - 0 (10B)
CHL:_ ID:_ Drive ALERT: Unexpected Sense Received (B)
CHL:_ ID:_ Drive ALERT: Unexpected Drive Not Ready (__)
CHL:_ ID:_ Drive ALERT: Drive HW Error (__)
CHL:_ ID:_ Target ALERT: Data Overrun/Underrun Detected
CHL:_ ID:_ Target ALERT: Invalid Status/Sense Data Received (10B)
CHL:_ ID:_ Target ALERT: Negotiation Error Detected
CHL:_ ID:_ Target ALERT: Unit Attention Received (10B)
CHL:_ ID:_ ALERT: Redundant Path for Chl:_ ID:_ Failure Detected
CHL:_ ID:_ ALERT: Media Scan Bad Block Unrecoverable-0x0
CHL:_ ID:_ Target ALERT: Gross Phase/Signal Error Detected
CHL:_ ID:_ Target ALERT: Timeout Waiting for I/O to Complete
CHL:_ ID:_ Target ALERT: Unexpected Disconnect Encountered
CHL:_ ID:_ Target ALERT: Unexpected Select Timeout
CHL:_ ID:_ Drive ALERT: Bad Block Encountered - 0 (184) W
CHL:_ ID:_ ALERT: Media Error Recovered-_x__
CHL:_ ID:_ ALERT: Media Error Unrecoverable-_x__

Warning:

[] SMART-CH:_ ID:_ Predictable Failure Detected (TEST)
>[] SMART-CH:_ ID:_ Predictable Failure Detected
>[] SMART-CH:_ ID:_ Predictable Failure Detected - Starting Clone
>[] SMART-CH:_ ID:_ Predictable Failure Detected - Clone Failed

CHL:_ ID:_ ALERT: Redundant Path for Chl:_ ID:_ Failure Detected

Notification:

CHL:_ ID:_ Drive NOTICE: Scan Drive Successful

CHL:_ ID:_ NOTICE: Redundant Path for Chl:_ ID:_ Restored

Channel:

Alert:

CHL:_ FATAL ERROR(_)

CHL:_ Host Channel ALERT: Bus Reset Issued

CHL:_ Host Channel ALERT: Channel Failure

CHL:_ ALERT: Fibre Channel Loop Failure Detected

CHL:_ ALERT: Redundant Loop Connection Error Detected on ID:11

CHL:_ ALERT: Redundant Loop for Chl:_ Failure Detected

CHL:_ ALERT: Redundant Path for Chl:_ ID:_ Expected but Not Found

CHL:_ Drive Channel ALERT: Data Overrun/Underrun Detected

CHL:_ Drive Channel ALERT: Invalid Status/Sense Data Received

CHL:_ Drive Channel ALERT: Negotiation Error Detected

CHL:_ Drive Channel ALERT: Unit Attention Received

CHL:_ RCC Channel ALERT: Data Overrun/Underrun Detected

CHL:_ RCC Channel ALERT: Invalid Status/Sense Data Received

CHL:_ RCC Channel ALERT: Negotiation Error Detected

CHL:_ RCC Channel ALERT: Unit Attention Received

CHL:_ Host Channel ALERT: Parity/CRC Error Detected

CHL:_ Drive Channel ALERT: Gross Phase/Signal Error Detected

CHL:_ Drive Channel ALERT: Timeout Waiting for I/O to Complete

CHL:_ Drive Channel ALERT: Unexpected Disconnect Encountered

CHL:_ Drive Channel ALERT: Unexpected Select Timeout

CHL:_ ID:1 Host Channel ALERT: Parity/CRC Error Detected

CHL:_ RCC Channel ALERT: Gross Phase/Signal Error Detected

CHL:_ RCC Channel ALERT: Parity/CRC Error Detected

CHL:_ RCC Channel ALERT: Timeout Waiting for I/O to Complete

CHL:_ RCC Channel ALERT: Unexpected Disconnect Encountered

CH:_ LIP (_ _) Detected

Warning:

CHL:_ ALERT: Fibre Channel Loop Failure Detected

CHL:_ ALERT: Redundant Loop for Chl:_ Failure Detected

CHL:_ ALERT; Redundant Path for Chl:_ OD:_ Expected but not Found

CHL:_ ID:_ ALERT: Redundant Path for Chl:_ ID:_ Failure Detected

Notification:

CHL:_ Host Channel Notification: Bus Reset Issued

CHL:_ NOTICE: Fibre Channel Loop Connection Restored

CHL:_ LIP(FF B) Detected
CHL:_ ID:_ NOTICE: Redundant Path for Chl:_ ID:_ Restored

Logical Drive Events

Alert:

LG:_ ALERT: CHL:_ ID:_ Media Scan Aborted
LG:_ ALERT: CHL:_ ID:_ Media Scan Failed
LG:_ ALERT: Logical Drive BAD Block Marked 000000084
LG:_ ALERT: Logical Drive Media Error Recovered 000000084
LG:_ Logical Drive ALERT: CHL:_ ID:_ Drive Failure
LG:_ Logical Drive ALERT: CHL:_ ID:_ Drive Missing
LG:_ Logical Drive ALERT: Creation Aborted
LG:_ Logical Drive ALERT: Creation Failed
LG:_ Logical Drive ALERT: Expansion Failed
LG:_ Logical Drive ALERT: Expansion Aborted
LG:_ Logical Drive ALERT: Initialization Failed
LG:_ Logical Drive ALERT: Initialization Aborted
LG:_ Logical Drive ALERT: Logical Drive Bad Block Table BAD
LG:_ Logical Drive ALERT: Logical Drive Bad Block Table FULL
LG:_ Logical Drive ALERT: Logical Drive On-Line Init Table BAD
LG:_ Logical Drive ALERT: Parity Regeneration Failed
LG:_ Logical Drive ALERT: Parity Regeneration Aborted
LG:_ Logical Drive ALERT: Rebuild Aborted
LG:_ Logical Drive ALERT: Rebuild Failed
LG:_ Logical Drive ALERT:CHL:_ ID:_ Clone Failed
LG:_ Logical Drive ALERT:CHL:_ ID:_ Clone Aborted
LG:_ ALERT: Inconsistent Parity Encountered Block 20000000B
ALERT: CHL:_ ID:_ Media Scan Failed

Notification:

Creation of Logical Drive _ Completed
LG:_ Logical Drive NOTICE: Add Drive Operation Paused
LG:_ Logical Drive NOTICE: Continue Add Drive Operation
LG:_ Logical Drive NOTICE: Continue Parity Regeneration Operation
LG:_ Logical Drive NOTICE: Continue Rebuild Operation
LG:_ Logical Drive NOTICE: Continue Clone Operation
LG:_ Logical Drive NOTICE: Starting Add Drive Operation
LG:_ Logical Drive NOTICE: Starting Creation
LG:_ Logical Drive NOTICE: Starting Off-Line Expansion
LG:_ Logical Drive NOTICE: Starting Off-Line Initialization
LG:_ Logical Drive NOTICE: Starting On-Line Expansion
LG:_ Logical Drive NOTICE: Starting On-Line Initialization
LG:_ Logical Drive NOTICE: Starting Parity Regeneration
LG:_ Logical Drive NOTICE: Starting Rebuild
LG:_ Logical Drive NOTICE:CHL:_ ID:_ Clone Completed
LG:_ Logical Drive NOTICE:CHL:_ ID:_ Copy and Replace Completed

LG:_ Logical Drive NOTICE:CHL:_ ID:_ Starting Clone
LG:_ NOTICE: CHL:_ ID:_ Starting Media Scan
LG:_ NOTICE: Media Scan of CHL:_ ID:_ Completed
Off-Line Expansion of Logical Drive _ Completed
Off-Line Initialization of Logical Drive _ Completed
On-Line Expansion of Logical Drive _ Completed
On-Line Initialization of Logical Drive _ Completed
Parity Regeneration of Logical Drive _ Completed
Rebuild of Logical Drive _ Completed
Add Drive to Logical Drive_ Completed
NOTICE: Media Scan of CHL:_ ID:_ Completed
NOTICE: CHL:_ ID:_ Starting Media Scan

General Target Events

Alert:

SAF-TE Devices:

SAF-TE Device(_)ALERT: Cooling Fan Failure Detected(:_)
SAF-TE Device(_)ALERT: Cooling Fan Not Installed(:_)
SAF-TE Device(_)ALERT: Elevated Temperature Alert
SAF-TE Device(_)ALERT: Power Supply Failure Detected(:_)
SAF-TE Device(_)ALERT: UPS Power Failure Detected

RAID Controller:

Peripheral Device ALERT: CPU Cold Temperature Detected(0.0(C))
Peripheral Device ALERT: Elevated Temperature Alert
BBU Absent or Failed! Correct It and Reset Ctlr to Take Effect
Controller FAN _ <high/low threshold> Speed Detected (_RPM)
+3.3V <upper/lower threshold> Voltage Detected (_)

Enclosure Devices:

Peripheral Set _ Device ALERT: Cold Temperature _ Detected(_(C))
Peripheral Set _ Device ALERT: FAN _ Failure Detected
Peripheral Set _ Device ALERT: FAN _ Not Present
Peripheral Set _ Device ALERT: Low FAN _ Speed Detected(_ RPM)
Peripheral Set _ Device ALERT: Low Power Supply _ Voltage Detected(_V)
Peripheral Set _ Device ALERT: Temperature Sensor _ Failure Detected
Peripheral Set _ Device ALERT: Temperature Sensor _ Not Present
Peripheral Set _ Device ALERT: Cold Temperature _ Detected (_(C))
Peripheral Set _ Device ALERT: Power Supply _ Failure Detected
Peripheral Set _ Device ALERT: Power Supply _ Not Present
Peripheral Set _ Device ALERT: UPS _ AC Power Failure Detected
Peripheral Set _ Device ALERT: UPS _ Battery Failure Detected
Peripheral Device ALERT: Elevated Temperature Alert
UPS Connection Is Absent

SES Devices:

SES(C_I)Cooling Fan _:Device Not Supported !
SES(C_I)Power Supply_:Device Not Supported !
SES(C_I)Temp Sensor _:Device Not Supported !
SES(C_I)UPS _:Device Not Supported !

General Peripheral Devices:

ALERT: UPS AC Power-Loss Detected
ALERT: UPS Power Failure Detected
ALERT: UPSBattery Low _%

Warning:

Warning: UPS AC Power-Loss Detected
Warning: UPS Battery Low - _%

Notification:**SAF-TE Devices:**

SAF-TE Device(_) NOTICE: Power Supply Back On-Line(._)
SAF-TE Device(_) NOTICE: Temperature Back To Non-Critical Levels
SAF-TE Device(_) NOTICE: Fan Back On-Line(._)
SAF-TE Device(_) NOTICE: UPS Power Back On-Line

SES Devices:

SES(C_I)Cooling Fan _:Fan Back On-Line
SES(C_I)Power Supply _:Power Supply Back On-Line
SES(C_I)Temp Sensor _:Temperature Back To Non-Critical Levels
SES(C_I)UPS _:UPS Power Back On-Line

Controller Self Diagnostics:

Board _ <high/low threshold> Temperature Back To Non-Critical Levels (_ C)

Enclosure Devices:

Peripheral Device NOTICE: Fan Back On-Line
Peripheral Set _ Device NOTICE: FAN_ Back On-Line
Peripheral Set _ Device NOTICE: FAN_ Back On-Line(_ RPM)
Peripheral Set _ Device NOTICE: FAN_ is Present
Peripheral Set _ Device NOTICE: Temperature _ Back To Non-Critical Levels
Peripheral Set _ Device NOTICE: Temperature _ Back To Non-Critical Levels(_C)

Peripheral Set _ Device NOTICE: Temperature _ is Present
 Peripheral Set _ Device NOTICE: Power Supply _ Back On-Line
 Peripheral Set _ Device NOTICE: Power Supply _ Back On-Line(_ _V)
 Peripheral Set _ Device NOTICE: Power Supply _ is Present
 Peripheral Set _ Device NOTICE: UPS _ AC Power Back On-Line
 Peripheral Set _ Device NOTICE: UPS _ Battery Back On-Line
 Power Supply _ Back-Online
 UPS AC Power Restored
 UPS Battery Restored To Safe Level
 UPS Connection Detected
 NOTICE: FAN Module _ Back On-Line(FAN_ _RPM)

Controller Events

Alert:

<i>Terminal</i>	Controller SDRAM ECC <multi-bits/single-bit> Error Detected		
<i>Event Type</i>	<input checked="" type="checkbox"/> Alert	<input type="checkbox"/> Warning	<input type="checkbox"/> Notification
<i>What Happens?</i>	A DRAM ECC detected error encountered.		
<i>What to Do?</i>	Contact your RAID system supplier and replace with new module(s) if necessary.		
<i>Terminal</i>	Controller SDRAM Parity Error Detected		
<i>Event Type</i>	<input checked="" type="checkbox"/> Alert	<input type="checkbox"/> Warning	<input type="checkbox"/> Notification
<i>What Happens?</i>	A DRAM parity error encountered.		
<i>What to Do?</i>	Contact your RAID system supplier and replace with new module(s) if necessary.		
<i>Terminal</i>	Controller ALERT: Power Supply Unstable or NVRAM Failed		
<i>Event Type</i>	<input checked="" type="checkbox"/> Alert	<input type="checkbox"/> Warning	<input type="checkbox"/> Notification
<i>What Happens?</i>	The output voltage drops below preset thresholds or NVRAM component failure.		
<i>What to Do?</i>			
<i>Terminal</i>	Controller ALERT: Redundant Controller Failure Detected		
<i>Event Type</i>	<input checked="" type="checkbox"/> Alert	<input type="checkbox"/> Warning	<input type="checkbox"/> Notification
<i>What Happens?</i>	One of the RAID controllers has failed.		
<i>What to Do?</i>	Contact your RAID system supplier for a replacement controller.		
<i>Terminal</i>	CHL:_ FATAL ERROR (_)		
<i>Event Type</i>	<input checked="" type="checkbox"/> Alert	<input type="checkbox"/> Warning	<input type="checkbox"/> Notification

<i>What Happens?</i>	One channel has failed.
<i>What to Do?</i>	Check if cable connectors are firmly seated and SCSI buses are properly terminated. With Fibre channels, disconnection may happen on the host side, hub or switch, etc. In redundant mode, the counterpart controller will take over and you may ask your system provider to remove the controller with a failed channel for a repair.

<i>Terminal</i>	Controller BBU Absent or Failed!		
<i>Event Type</i>	<input checked="" type="checkbox"/> Alert	<input type="checkbox"/> Warning	<input type="checkbox"/> Notification
<i>What Happens?</i>	BBU failed or disconnected.		
<i>What to Do?</i>	BBU is mounted on controller main board and is not accessed by users. Contact your RAID system supplier for a replacement unit.		

<i>Terminal</i>	Controller BBU Failure Detected		
<i>Event Type</i>	<input checked="" type="checkbox"/> Alert	<input type="checkbox"/> Warning	<input type="checkbox"/> Notification
<i>What Happens?</i>	BBU has failed.		
<i>What to Do?</i>	Contact your RAID system supplier for a replacement controller.		

<i>Terminal</i>	Controller BBU Not Fully Charged!		
<i>Event Type</i>	<input type="checkbox"/> Alert	<input checked="" type="checkbox"/> Warning	<input type="checkbox"/> Notification
<i>What Happens?</i>	BBU under charge and is unable to support some configuration change, e.g., changing the caching mode from write-through to write-back.		
<i>What to Do?</i>	Wait for the battery charge to complete or replace battery if it can no longer hold the charge.		

<i>Terminal</i>	Controller BBU Thermal Shutdown/Enter Sleep-Mode!		
<i>Event Type</i>	<input type="checkbox"/> Alert	<input checked="" type="checkbox"/> Warning	<input type="checkbox"/> Notification
<i>What Happens?</i>	Elevated temperature detected on the charge board. Fast charge halted.		
<i>What to Do?</i>	Wait for the battery charge to complete and make sure system cooling is operating normally.		

<i>Terminal</i>	Controller PCI Bus Parity Error Detected		
<i>Event Type</i>	<input checked="" type="checkbox"/> Alert	<input type="checkbox"/> Warning	<input type="checkbox"/> Notification
<i>What Happens?</i>	May be triggered by component failure or conditions like elevated temperature.		
<i>What to Do?</i>	Contact your RAID system supplier for an onsite support.		

Warning:

<i>Terminal</i>	Memory Not Sufficient to Fully Support Current Config.		
<i>Event Type</i>	<input type="checkbox"/> Alert	<input checked="" type="checkbox"/> Warning	<input type="checkbox"/> Notification
<i>What</i>	The installed size of memory does not support current configuration.		

<i>Happens?</i>	Try increase memory size.
<i>What to Do?</i>	

<i>Terminal</i>	Controller BBU Not Fully Charged!		
<i>Event Type</i>	<input type="checkbox"/> Alert	<input checked="" type="checkbox"/> Warning	<input type="checkbox"/> Notification
<i>What Happens?</i>	BBU under charge and is unable to support some configuration change, e.g., changing the caching mode from write-through to write-back.		
<i>What to Do?</i>	Wait for the battery charge to complete or replace battery if it can no longer hold the charge.		

<i>Terminal</i>	Force Controller Write-Through on Triggered Cause		
<i>Event Type</i>	<input checked="" type="checkbox"/> Alert	<input type="checkbox"/> Warning	<input type="checkbox"/> Notification
<i>What Happens?</i>	Critical working conditions, e.g., component failure, forced the subsystem to adopt a safer caching mode.		
<i>What to Do?</i>	Restore normal working condition, or contact your RAID system supplier for help.		

Notification:

<i>Terminal</i>	CONTROLLER notice: NVRAM Factory Defaults Restored		
<i>Event Type</i>	<input type="checkbox"/> Alert	<input type="checkbox"/> Warning	<input checked="" type="checkbox"/> Notification
<i>What Happens?</i>	Firmware settings have been restored to factory defaults. Options for restoring defaults are not available to users and are only reserved for qualified engineers.		
<i>What to Do?</i>	Press ESC to clear the message.		

<i>Terminal</i>	Controller Initialization Completed		
<i>Event Type</i>	<input type="checkbox"/> Alert	<input type="checkbox"/> Warning	<input checked="" type="checkbox"/> Notification
<i>What Happens?</i>	Controller initialization completed .		
<i>What to Do?</i>			

<i>Terminal</i>	Controller NOTICE: Redundant Controller Firmware Updated		
<i>Event Type</i>	<input type="checkbox"/> Alert	<input type="checkbox"/> Warning	<input checked="" type="checkbox"/> Notification
<i>What Happens?</i>	RAID controllers have finished shifting I/Os, resetting, and have come online with new version of firmware.		
<i>What to Do?</i>	Press ESC to clear the message.		

<i>Terminal</i>	Memory is Now Sufficient to Fully Support Current Config.		
<i>Event Type</i>	<input type="checkbox"/> Alert	<input type="checkbox"/> Warning	<input checked="" type="checkbox"/> Notification
<i>What Happens?</i>	Memory size has been expanded.		

<i>What to Do?</i>	Press ESC to clear the message.
<i>Terminal</i>	NVRAM Restore from Disk is Completed
<i>Event Type</i>	<input type="checkbox"/> Alert <input type="checkbox"/> Warning <input checked="" type="checkbox"/> Notification
<i>What Happens?</i>	Firmware configuration data previously saved to disk is restored.
<i>What to Do?</i>	Press ESC to clear the message.
<i>Terminal</i>	NVRAM Restore from File is Completed
<i>Event Type</i>	<input type="checkbox"/> Alert <input type="checkbox"/> Warning <input checked="" type="checkbox"/> Notification
<i>What Happens?</i>	Firmware configuration data previously saved as a file is restored.
<i>What to Do?</i>	Press ESC to clear the message.
<i>Terminal</i>	NOTICE: Controller BBU Back On-Line!
<i>Event Type</i>	<input type="checkbox"/> Alert <input type="checkbox"/> Warning <input checked="" type="checkbox"/> Notification
<i>What Happens?</i>	BBU connected or restored..
<i>What to Do?</i>	Press ESC to clear the message.
<i>Terminal</i>	NOTICE: Controller BBU Fully Charged!
<i>Event Type</i>	<input type="checkbox"/> Alert <input type="checkbox"/> Warning <input checked="" type="checkbox"/> Notification
<i>What Happens?</i>	BBU charging completed.
<i>What to Do?</i>	Press ESC to clear the message.
<i>Terminal</i>	NOTICE: Controller BBU Present!
<i>Event Type</i>	<input type="checkbox"/> Alert <input type="checkbox"/> Warning <input checked="" type="checkbox"/> Notification
<i>What Happens?</i>	BBU once absent is now restored.
<i>What to Do?</i>	Press ESC to clear the message.
<i>Terminal</i>	NOTICE: Controller FAN On-Line(_RPM)
<i>Event Type</i>	<input type="checkbox"/> Alert <input type="checkbox"/> Warning <input checked="" type="checkbox"/> Notification
<i>What Happens?</i>	Controller fan back on-line.
<i>What to Do?</i>	Press ESC to clear the message.

Channel/Disk Drive

Disk Drive

Alert:

<i>Terminal</i>	CHL:_ ID:_ SCSI Target ALERT: Unexpected Select Timeout
<i>Event Type</i>	<input checked="" type="checkbox"/> Alert <input type="checkbox"/> Warning <input type="checkbox"/> Notification
<i>What Happens?</i>	Drive SCSI target select timeout. The specified hard drive cannot be selected by the controller. Whether the drive has been removed, or the cabling/termination/canister is out of order.
<i>What to Do?</i>	Check drive-side SCSI cable/termination and drive canister connections.

<i>Terminal</i>	CHL:_ ID:_ SCSI Target ALERT: Gross Phase/Signal Error Detected
<i>Event Type</i>	<input checked="" type="checkbox"/> Alert <input type="checkbox"/> Warning <input type="checkbox"/> Notification
<i>What Happens?</i>	Drive-side SCSI phase/signal abnormality detected.
<i>What to Do?</i>	Press <ESC> to clear the message.

<i>Terminal</i>	CHL:_ ID:_ SCSI Target ALERT: Unexpected Disconnect Encountered
<i>Event Type</i>	<input checked="" type="checkbox"/> Alert <input type="checkbox"/> Warning <input type="checkbox"/> Notification
<i>What Happens?</i>	Drive-side SCSI target unexpected disconnect detected.
<i>What to Do?</i>	Check cabling/termination and canister connections.

<i>Terminal</i>	CHL:_ ID:_ SCSI Drive ALERT: Negotiation Error Detected
<i>Event Type</i>	<input checked="" type="checkbox"/> Alert <input type="checkbox"/> Warning <input type="checkbox"/> Notification
<i>What Happens?</i>	Drive-side SCSI target sync/wide negotiation abnormality detected.
<i>What to Do?</i>	

<i>Terminal</i>	CHL:_ ID:_ SCSI Target ALERT: Timeout Waiting for I/O to Complete
<i>Event Type</i>	<input checked="" type="checkbox"/> Alert <input type="checkbox"/> Warning <input type="checkbox"/> Notification
<i>What Happens?</i>	Drive-side SCSI target I/O timeout. Possible drive-side cabling/termination and canister connection abnormal or drive malfunctioning.
<i>What to Do?</i>	Check drive-side cabling/termination/canister connections and hard drive.

<i>Terminal</i>	CHL:_ ID:_ SCSI Target ALERT: SCSI Parity/CRC Error Detected
<i>Event Type</i>	<input checked="" type="checkbox"/> Alert <input type="checkbox"/> Warning <input type="checkbox"/> Notification
<i>What Happens?</i>	Drive-side SCSI channel parity or CRC error detected to the specified hard drive.
<i>What to Do?</i>	Check drive-side cable/termination or drive canister connection.

Do?	
Terminal	CHL:_ ID:_ SCSI Target ALERT: Data Overrun/Underrun Detected
Event Type	<input checked="" type="checkbox"/> Alert <input type="checkbox"/> Warning <input type="checkbox"/> Notification
What Happens?	Drive-side SCSI target data overrun or underrun detected.
What to Do?	Check drive-side cabling/termination/canister connections and hard drive.
Terminal	CHL:_ ID:_ SCSI Target ALERT: Invalid Status/Sense Data Received (Sense_key Sense_code)
Event Type	<input checked="" type="checkbox"/> Alert <input type="checkbox"/> Warning <input type="checkbox"/> Notification
What Happens?	Drive-side SCSI invalid status/sense data received from target
What to Do?	Check cabling/termination/canister connections.
Terminal	CHL:_ ID:_ SCSI Drive ALERT: Drive HW Error (Sense_key Sense_code)
Event Type	<input checked="" type="checkbox"/> Alert <input type="checkbox"/> Warning <input type="checkbox"/> Notification
What Happens?	Drive-Side SCSI drive unrecoverable hardware error reported
What to Do?	Replace hard drive and the rebuild may begin with a hot-spare or a replacement drive
Terminal	CHL:_ ID:_ SCSI Drive ALERT: Bad Block Encountered - Block_number (Sense_key Sense_code)
Event Type	<input checked="" type="checkbox"/> Alert <input type="checkbox"/> Warning <input type="checkbox"/> Notification
What Happens?	Hard drive unrecoverable media error reported. A bad block is encountered in the specified hard drive. The RAID controller will ask the hard drive to retry.
What to Do?	Press [ESC] to clear the message.
Terminal	CHL:_ ID:_ SCSI Drive ALERT: CHL:_ ID:_ Clone Failed
Event Type	<input checked="" type="checkbox"/> Alert <input type="checkbox"/> Warning <input type="checkbox"/> Notification
What Happens?	Drive installed does not respond with "Ready"
What to Do?	Check hard drive and drive-side cabling/termination/canister connections.
Terminal	Slot __ Drive ALERT: Bad Block Encountered - *****
Event Type	<input checked="" type="checkbox"/> Alert <input type="checkbox"/> Warning <input type="checkbox"/> Notification
What Happens?	Occurrences of bad blocks found by Media Scan or during the rebuild process, in a RAID 1/3/5 array. If you see "Bad Block Encountered" but there are no subsequent events, it means data affected by the bad blocks have been reconstructed by the controller and committed to the original drive sector or to other healthy sector.
What to Do?	

Terminal	CHL:_ ID:_ SCSI Target ALERT: Unit Attention Received (<i>Sense_key Sense_code</i>)
Event Type	<input checked="" type="checkbox"/> Alert <input type="checkbox"/> Warning <input type="checkbox"/> Notification
What Happens?	Drive-side SCSI target unit attention received.
What to Do?	Check hard drive and drive-side cabling/termination/canister connections.

Terminal	CHL:_ ID:_ SCSI Drive ALERT: Unexpected Sense Received (<i>Sense_key Sense_code</i>)
Event Type	<input checked="" type="checkbox"/> Alert <input type="checkbox"/> Warning <input type="checkbox"/> Notification
What Happens?	Drive-side SCSI drive unexpected sense data received.
What to Do?	Checking drive-side cabling/termination/drive canister connections. This might result from a bad signal quality of poor connection, etc.

Terminal	CHL:_ ID:_ SCSI Drive ALERT: Block Reassignment Failed - <i>Block_number</i> (<i>Sense_key Sense_code</i>)
Event Type	<input checked="" type="checkbox"/> Alert <input type="checkbox"/> Warning <input type="checkbox"/> Notification
What Happens?	Drive-side block reassignment failed. Drive will be considered failed.
What to Do?	Press [ESC] to clear this error message.

Terminal	CHL:_ ID:_ SCSI Drive ALERT: Aborted Command (<i>Sense_key Sense_code</i>)
Event Type	<input checked="" type="checkbox"/> Alert <input type="checkbox"/> Warning <input type="checkbox"/> Notification
What Happens?	SCSI drive aborted command reported
What to Do?	Press [ESC] to clear the error message.

Terminal	CHL:_ ID:_ ALERT: Media Scan Bad Block Unrecoverable-0x0
Event Type	<input checked="" type="checkbox"/> Alert <input type="checkbox"/> Warning <input type="checkbox"/> Notification
What Happens?	Media Scan unable to repair bad blocks.
What to Do?	Press [ESC] to clear the error message.

Warning

Terminal	SMART-CH:_ ID:_ Predictable Failure Detected (TEST)
Event Type	<input type="checkbox"/> Alert <input checked="" type="checkbox"/> Warning <input type="checkbox"/> Notification
What Happens?	This message appears when simulating the SMART detect function. This message shows that your drives support SMART functions.
What to Do?	Press [ESC] to clear the error message.

<i>Do?</i>	
------------	--

<i>Terminal</i>	SMART-CH:_ ID:_ Predictable Failure Detected
<i>Event Type</i>	<input type="checkbox"/> Alert <input checked="" type="checkbox"/> Warning <input type="checkbox"/> Notification
<i>What Happens?</i>	SMART-related errors detected. This message will only be displayed when SMART detect is enabled.
<i>What to Do?</i>	

<i>Terminal</i>	SMART-CH:_ ID:_ Predictable Failure Detected-Starting Clone
<i>Event Type</i>	<input type="checkbox"/> Alert <input checked="" type="checkbox"/> Warning <input type="checkbox"/> Notification
<i>What Happens?</i>	SMART errors detected, a spare is conducted to rebuild and to replace the faulty drive. This is a response to the preset scheme.
<i>What to Do?</i>	

<i>Terminal</i>	SMART-CH:_ ID:_ Predictable Failure Detected-Clone Failed
<i>Event Type</i>	<input type="checkbox"/> Alert <input checked="" type="checkbox"/> Warning <input type="checkbox"/> Notification
<i>What Happens?</i>	SMART errors detected and a spare is conducted to rebuild. The cloning process is halted due to power interruption and some other reasons.
<i>What to Do?</i>	

Notification:

<i>Terminal</i>	CHL:_ ID:_ SCSI Drive ALERT: Block Successfully Reassigned - Block_number (Sense_key Sense_code)
<i>Event Type</i>	<input type="checkbox"/> Alert <input type="checkbox"/> Warning <input checked="" type="checkbox"/> Notification
<i>What Happens?</i>	Bad blocks have been reassigned successfully
<i>What to Do?</i>	Press [ESC] to clear this message.

<i>Terminal</i>	CHL:_ ID:_ SCSI Drive NOTICE: Scan SCSI Drive Successful
<i>Event Type</i>	<input type="checkbox"/> Alert <input type="checkbox"/> Warning <input checked="" type="checkbox"/> Notification
<i>What Happens?</i>	Scanning a new drive from on a SCSI drive successful.
<i>What to Do?</i>	

Channel:**Alert:**

<i>Terminal</i>	CHL:_ ALERT: Redundant Loop Connection Error Detected on ID:_		
<i>Event Type</i>	<input checked="" type="checkbox"/> Alert	<input type="checkbox"/> Warning	<input type="checkbox"/> Notification
<i>What Happens?</i>	One of the dual loop members may have failed or been disconnected. Make sure all channels are properly connected and topological configuration properly set.		
<i>What to Do?</i>	Check the redundant Fibre channel loop connection is right.		

<i>Terminal</i>	CHL:_ Host Channel ALERT: Channel Failure		
<i>Event Type</i>	<input checked="" type="checkbox"/> Alert	<input type="checkbox"/> Warning	<input type="checkbox"/> Notification
<i>What Happens?</i>	Specific host channel may have failed or disconnected.		
<i>What to Do?</i>	Check cable connection, Fibre hub, or switch connection. Contact your supplier if no connection errors could be found.		

<i>Terminal</i>	CHL:_ Drive Channel ALERT: Channel Failure		
<i>Event Type</i>	<input checked="" type="checkbox"/> Alert	<input type="checkbox"/> Warning	<input type="checkbox"/> Notification
<i>What Happens?</i>	Specific drive channel may have failed or disconnected.		
<i>What to Do?</i>	Check cable connection, Fibre hub, or switch connection. Contact your supplier if no connection errors could be found.		

<i>Terminal</i>	CHL:_ ALERT: Fibre Channel Loop Failure Detected		
<i>Event Type</i>	<input checked="" type="checkbox"/> Alert	<input type="checkbox"/> Warning	<input type="checkbox"/> Notification
<i>What Happens?</i>	Fibre channel loop failure is detected.		
<i>What to Do?</i>	Check cable connection, Fibre hub, or switch connection. Contact your supplier if no connection errors could be found.		

<i>Terminal</i>	CHL:_ ALERT: Redundant loop for Chl:_ Failure Detected		
<i>Event Type</i>	<input checked="" type="checkbox"/> Alert	<input type="checkbox"/> Warning	<input type="checkbox"/> Notification
<i>What Happens?</i>	The pair loop of channel:_ has failed.		
<i>What to Do?</i>	Check cable connection, Fibre hub, or switch connection. Contact your supplier if no connection errors could be found.		

<i>Terminal</i>	CHL:_ ALERT: Redundant Path for Chl:_ ID:_ Expected but Not Found		
<i>Event Type</i>	<input checked="" type="checkbox"/> Alert	<input type="checkbox"/> Warning	<input type="checkbox"/> Notification
<i>What Happens?</i>	Disconnection with the pair loop may have occurred.		
<i>What to Do?</i>	Check cable connection, Fibre hub, or switch connection. Contact your supplier if no connection errors could be found.		

<i>Terminal</i>	CHL:_ ID:_ ALERT: Redundant Path for Chl:_ ID:_ Failure Detected		
<i>Event Type</i>	<input checked="" type="checkbox"/> Alert	<input type="checkbox"/> Warning	<input type="checkbox"/> Notification
<i>What Happens?</i>	Disconnection with the pair loop may have occurred.		
<i>What to Do?</i>	Check cable connection, Fibre hub, or switch connection. Contact your supplier if no connection errors could be found.		
<i>Terminal</i>	CHL:_ Host Channel ALERT: Bus Reset Issued		
<i>Event Type</i>	<input checked="" type="checkbox"/> Alert	<input type="checkbox"/> Warning	<input type="checkbox"/> Notification
<i>What Happens?</i>	Bus reset issued on CHL:_ host channel.		
<i>What to Do?</i>			
<i>Terminal</i>	CHL:_ Drive Channel ALERT: Data Overrun/Underrun Detected		
<i>Event Type</i>	<input checked="" type="checkbox"/> Alert	<input type="checkbox"/> Warning	<input type="checkbox"/> Notification
<i>What Happens?</i>	Drive-side SCSI target data overrun or underrun detected..		
<i>What to Do?</i>			
<i>Terminal</i>	CHL:_ Drive Channel ALERT: Invalid Status/Sense Data Received		
<i>Event Type</i>	<input checked="" type="checkbox"/> Alert	<input type="checkbox"/> Warning	<input type="checkbox"/> Notification
<i>What Happens?</i>	Drive-side SCSI invalid status/sense data received from target.		
<i>What to Do?</i>			
<i>Terminal</i>	CHL:_ Drive Channel ALERT: Negotiation Error Detected		
<i>Event Type</i>	<input checked="" type="checkbox"/> Alert	<input type="checkbox"/> Warning	<input type="checkbox"/> Notification
<i>What Happens?</i>	Drive-side SCSI target sync/wide negotiation abnormality detected.		
<i>What to Do?</i>			
<i>Terminal</i>	CHL:_ Drive Channel ALERT: Unit Attention Received		
<i>Event Type</i>	<input checked="" type="checkbox"/> Alert	<input type="checkbox"/> Warning	<input type="checkbox"/> Notification
<i>What Happens?</i>	Drive-side SCSI target unit attention received.		
<i>What to Do?</i>			
<i>Terminal</i>	CHL:_ FATAL ERROR (_)		
<i>Event Type</i>	<input checked="" type="checkbox"/> Alert	<input type="checkbox"/> Warning	<input type="checkbox"/> Notification
<i>What Happens?</i>	CHL:_ failed.		
<i>What to Do?</i>			

<i>Terminal</i>	CHL:_ RCC Channel ALERT: Data Overrun/Underrun Detected		
<i>Event Type</i>	<input checked="" type="checkbox"/> Alert	<input type="checkbox"/> Warning	<input type="checkbox"/> Notification
<i>What Happens?</i>	RCC channel Drive-side SCSI target data overrun or underrun detected.		
<i>What to Do?</i>			
<i>Terminal</i>	CHL:_ RCC Channel ALERT: Invalid Status/Sense Data Received		
<i>Event Type</i>	<input checked="" type="checkbox"/> Alert	<input type="checkbox"/> Warning	<input type="checkbox"/> Notification
<i>What Happens?</i>	RCC channel invalid status/sense data received from target.		
<i>What to Do?</i>			
<i>Terminal</i>	CHL:_ RCC Channel ALERT: Negotiation Error Detected		
<i>Event Type</i>	<input checked="" type="checkbox"/> Alert	<input type="checkbox"/> Warning	<input type="checkbox"/> Notification
<i>What Happens?</i>	RCC channel target sync/wide negotiation abnormality detected..		
<i>What to Do?</i>			
<i>Terminal</i>	CHL:_ RCC Channel ALERT: Unit Attention Received		
<i>Event Type</i>	<input checked="" type="checkbox"/> Alert	<input type="checkbox"/> Warning	<input type="checkbox"/> Notification
<i>What Happens?</i>	RCC channel SCSI target unit attention received.		
<i>What to Do?</i>			
<i>Terminal</i>	CHL:_ Host Channel ALERT: Parity/CRC Error Detected		
<i>Event Type</i>	<input checked="" type="checkbox"/> Alert	<input type="checkbox"/> Warning	<input type="checkbox"/> Notification
<i>What Happens?</i>	Host-side parity or CRC error detected to the specified hard drive..		
<i>What to Do?</i>			
<i>Terminal</i>	CHL:_ Drive Channel ALERT: Gross Phase/Signal Error Detected		
<i>Event Type</i>	<input checked="" type="checkbox"/> Alert	<input type="checkbox"/> Warning	<input type="checkbox"/> Notification
<i>What Happens?</i>	Drive-side SCSI phase/signal abnormality detected..		
<i>What to Do?</i>			
<i>Terminal</i>	CHL:_ Drive Channel ALERT: Timeout Waiting for I/O to Complete		
<i>Event Type</i>	<input checked="" type="checkbox"/> Alert	<input type="checkbox"/> Warning	<input type="checkbox"/> Notification
<i>What Happens?</i>	Drive-side SCSI target I/O timeout. Possible drive-side cabling/termination and canister connection abnormal or drive malfunctioning.		

<i>What to Do?</i>	
<i>Terminal</i>	CHL:_ Drive Channel ALERT: Unexpected Disconnect Encountered
<i>Event Type</i>	<input checked="" type="checkbox"/> Alert <input type="checkbox"/> Warning <input type="checkbox"/> Notification
<i>What Happens?</i>	Drive-side SCSI target unexpected disconnect detected.
<i>What to Do?</i>	
<i>Terminal</i>	CHL:_ Drive Channel ALERT: Unexpected Select Timeout
<i>Event Type</i>	<input checked="" type="checkbox"/> Alert <input type="checkbox"/> Warning <input type="checkbox"/> Notification
<i>What Happens?</i>	Drive SCSI target select timeout. The specified hard drive cannot be selected by the RAID controller/subsystem. Whether the drive has been removed, or the cabling/termination/canister is out of order.
<i>What to Do?</i>	
<i>Terminal</i>	CHL:_ RCC Channel ALERT: Gross Phase/Signal Error Detected
<i>Event Type</i>	<input checked="" type="checkbox"/> Alert <input type="checkbox"/> Warning <input type="checkbox"/> Notification
<i>What Happens?</i>	RCC channel phase/signal abnormality detected..
<i>What to Do?</i>	
<i>Terminal</i>	CHL:_ RCC Channel ALERT: Parity/CRC Error Detected
<i>Event Type</i>	<input checked="" type="checkbox"/> Alert <input type="checkbox"/> Warning <input type="checkbox"/> Notification
<i>What Happens?</i>	RCC channel parity or CRC error detected to the specified hard drive..
<i>What to Do?</i>	
<i>Terminal</i>	CHL:_ RCC Channel ALERT: Timeout Waiting for I/O to Complete
<i>Event Type</i>	<input checked="" type="checkbox"/> Alert <input type="checkbox"/> Warning <input type="checkbox"/> Notification
<i>What Happens?</i>	RCC channel I/O timeout. Possible cabling and canister connection abnormal or backplane malfunctioning.
<i>What to Do?</i>	
<i>Terminal</i>	CHL:_ RCC Channel ALERT: Unexpected Disconnect Encountered
<i>Event Type</i>	<input checked="" type="checkbox"/> Alert <input type="checkbox"/> Warning <input type="checkbox"/> Notification
<i>What Happens?</i>	RCC channel unexpected disconnect detected.
<i>What to Do?</i>	

Notification:

<i>Terminal</i>	CHL:_ NOTICE: Fibre Channel Loop Connection Restored
<i>Event Type</i>	<input type="checkbox"/> Alert <input type="checkbox"/> Warning <input checked="" type="checkbox"/> Notification
<i>What Happens?</i>	Fibre loop connection restored.
<i>What to Do?</i>	Press <ESC> to clear the message.
<hr/>	
<i>Terminal</i>	CHL:_ ID:_ NOTICE: Redundant Path for Chl:_ ID:_ Restored
<i>Event Type</i>	<input type="checkbox"/> Alert <input type="checkbox"/> Warning <input checked="" type="checkbox"/> Notification
<i>What Happens?</i>	The connection with pair loop regained.
<i>What to Do?</i>	Press <ESC> to clear the message.
<hr/>	
<i>Terminal</i>	CHL:_ SCSI Drive Channel Notification: SCSI Bus Reset Issued
<i>Event Type</i>	<input type="checkbox"/> Alert <input type="checkbox"/> Warning <input checked="" type="checkbox"/> Notification
<i>What Happens?</i>	SCSI bus reset issued.
<i>What to Do?</i>	
<hr/>	
<i>Terminal</i>	CHL:_ Host Channel Notification: SCSI Bus Reset Issued
<i>Event Type</i>	<input type="checkbox"/> Alert <input type="checkbox"/> Warning <input checked="" type="checkbox"/> Notification
<i>What Happens?</i>	Host channel bus reset issued.
<i>What to Do?</i>	
<hr/>	
<i>Terminal</i>	CHL:_ LIP(__) Detected
<i>Event Type</i>	<input type="checkbox"/> Alert <input type="checkbox"/> Warning <input checked="" type="checkbox"/> Notification
<i>What Happens?</i>	Fibre Loop LIP issued.
<i>What to Do?</i>	Press [ESC] to clear the error message.

Logical Drive Events:

Alert:

<i>Terminal</i>	LG: _ ALERT: CHL:_ ID:_ Media Scan Aborted		
<i>Event Type</i>	<input checked="" type="checkbox"/> Alert	<input type="checkbox"/> Warning	<input type="checkbox"/> Notification
<i>What Happens?</i>	Media Scan has been forced to stop for certain reasons, e.g., critical system events occurred.		
<i>What to Do?</i>	Media Scan can be manually started once the normal system condition is restored.		

<i>Terminal</i>	LG: _ ALERT: CHL:_ ID:_ Media Scan Failed		
<i>Event Type</i>	<input checked="" type="checkbox"/> Alert	<input type="checkbox"/> Warning	<input type="checkbox"/> Notification
<i>What Happens?</i>	Media Scan has been failed to carry on for certain reasons, e.g., logical drive has fatally failed.		
<i>What to Do?</i>	Contact your RAID supplier for further information.		

<i>Terminal</i>	LG:_ Logical Drive ALERT: Logical Drive Block Marked _____		
<i>Event Type</i>	<input checked="" type="checkbox"/> Alert	<input type="checkbox"/> Warning	<input type="checkbox"/> Notification
<i>What Happens?</i>	Bad blocks have been located by comparing and recalculating parity. The host computer will receive media error messages if host accesses fall within the affected blocks.		
<i>What to Do?</i>	An attempt to recover data from the associated data blocks will be performed.		

<i>Terminal</i>	LG:_ Logical Drive ALERT: Logical Drive Block Recovered _____		
<i>Event Type</i>	<input checked="" type="checkbox"/> Alert	<input type="checkbox"/> Warning	<input type="checkbox"/> Notification
<i>What Happens?</i>	Data in bad blocks has been recovered by controller comparing and recalculating parity.		
<i>What to Do?</i>	Press ESC to clear the message.		

<i>Terminal</i>	LG:_ Logical Drive ALERT: Logical Drive Block Marked BAD		
<i>Event Type</i>	<input checked="" type="checkbox"/> Alert	<input type="checkbox"/> Warning	<input type="checkbox"/> Notification
<i>What Happens?</i>	This message means data in bad blocks can not be recovered by controller comparing and recalculating parity. The host computer will receive media error messages if host accesses fall within the affected blocks.		
<i>What to Do?</i>			

<i>Terminal</i>	LG: Logical Drive ALERT: CHL:_ ID:_ Drive Failure		
<i>Event Type</i>	<input checked="" type="checkbox"/> Alert	<input type="checkbox"/> Warning	<input type="checkbox"/> Notification
<i>What Happens?</i>	The specified hard drive in the specified logical drive has failed.		

<i>What to Do?</i>	If a spare is available, the controller will automatically start rebuild. If there is no spare, replace the faulty drive and rebuild will be automatically initiated.		
<i>Terminal</i>	LG: Logical Drive ALERT: CHL:_ ID:_ Drive Missing		
<i>Event Type</i>	<input checked="" type="checkbox"/> Alert	<input type="checkbox"/> Warning	<input type="checkbox"/> Notification
<i>What Happens?</i>	The specified hard drive in the specified logical drive is missing.		
<i>What to Do?</i>	The drive could have been accidentally removed or drive connection problem occurred. Check drive connection and related enclosure status.		
<i>Terminal</i>	LG: Logical Drive ALERT: Creation Aborted		
<i>Event Type</i>	<input checked="" type="checkbox"/> Alert	<input type="checkbox"/> Warning	<input type="checkbox"/> Notification
<i>What Happens?</i>	System forced to abort logical drive creation process.		
<i>What to Do?</i>	Check proper system working conditions.		
<i>Terminal</i>	LG: Logical Drive ALERT: Creation Failed		
<i>Event Type</i>	<input checked="" type="checkbox"/> Alert	<input type="checkbox"/> Warning	<input type="checkbox"/> Notification
<i>What Happens?</i>	System forced to abort logical drive creation process. Drive abnormality could have occurred.		
<i>What to Do?</i>	Check proper system working conditions and drive connection.		
<i>Terminal</i>	LG: Logical Drive ALERT: Creation Aborted		
<i>Event Type</i>	<input checked="" type="checkbox"/> Alert	<input type="checkbox"/> Warning	<input type="checkbox"/> Notification
<i>What Happens?</i>	System forced to abort logical drive creation process.		
<i>What to Do?</i>	Check proper system working conditions.		
<i>Terminal</i>	LG:_ Logical Drive ALERT: Expansion Failed		
<i>Event Type</i>	<input checked="" type="checkbox"/> Alert	<input type="checkbox"/> Warning	<input type="checkbox"/> Notification
<i>What Happens?</i>	Logical drive expansion failed. It could result from one of the following reasons: 1. The expansion has been canceled by user. 2. The drive used for expansion might have failed during rebuild. 3. Bad blocks are encountered on another member drive during the rebuild. 4. One member drive has failed.		
<i>What to Do?</i>	Carefully identify and replace the faulty drive and perform logical drive initialization again.		
<i>Terminal</i>	LG:_ Logical Drive ALERT: Initialization Failed		
<i>Event Type</i>	<input checked="" type="checkbox"/> Alert	<input type="checkbox"/> Warning	<input type="checkbox"/> Notification
<i>What Happens?</i>	Logical drive initialization failed. It could result from one of the following reasons:		

	<ol style="list-style-type: none"> 1. One of the drives used for a logical drive might have failed during rebuild. 2. Bad blocks are encountered on another member drive during the rebuild. 3. Drive hardware faults might have occurred.
<i>What to Do?</i>	Carefully identify and replace the faulty drive and perform logical drive initialization again.
<i>Terminal</i>	LG: Logical Drive ALERT: Logical Drive Bad Block Table BAD
<i>Event Type</i>	<input checked="" type="checkbox"/> Alert <input type="checkbox"/> Warning <input type="checkbox"/> Notification
<i>What Happens?</i>	System failed to generate a bad block table. Logical drive may have serious integrity problem.
<i>What to Do?</i>	Check proper system working conditions.
<i>Terminal</i>	LG: Logical Drive ALERT: Logical Drive Bad Block Table FULL
<i>Event Type</i>	<input checked="" type="checkbox"/> Alert <input type="checkbox"/> Warning <input type="checkbox"/> Notification
<i>What Happens?</i>	Available bad block table entries full.
<i>What to Do?</i>	Check proper system working conditions. Contact system vendor for help.
<i>Terminal</i>	LG: Logical Drive ALERT: Logical Drive On-Line Init Table BAD
<i>Event Type</i>	<input checked="" type="checkbox"/> Alert <input type="checkbox"/> Warning <input type="checkbox"/> Notification
<i>What Happens?</i>	Serious system faults might have occurred and forced the initialization to halt.
<i>What to Do?</i>	Check proper system working conditions. Contact system vendor for help.
<i>Terminal</i>	LG: Logical Drive ALERT: Parity Regeneration Failed
<i>Event Type</i>	<input checked="" type="checkbox"/> Alert <input type="checkbox"/> Warning <input type="checkbox"/> Notification
<i>What Happens?</i>	System faults or integrity problems forced system to abandon the operation.
<i>What to Do?</i>	Check proper system working conditions. Contact system vendor for help.
<i>Terminal</i>	LG:_ Logical Drive ALERT: Rebuild Aborted
<i>Event Type</i>	<input checked="" type="checkbox"/> Alert <input type="checkbox"/> Warning <input type="checkbox"/> Notification
<i>What Happens?</i>	<p>Logical drive rebuild aborted. It could result from one of the following reasons:</p> <ol style="list-style-type: none"> 1. The rebuild has been canceled by user. 2. The drive used for rebuild might have failed during rebuild. 3. Bad blocks are encountered on another member drive during the rebuild. 4. System faults occurred.
<i>What to Do?</i>	Carefully identify and replace the faulty drive and perform logical drive rebuild. It is best to stop host I/Os temporarily to this logical drive.

Terminal	LG:_ Logical Drive ALERT: Rebuild Failed		
Event Type	<input checked="" type="checkbox"/> Alert	<input type="checkbox"/> Warning	<input type="checkbox"/> Notification
What Happens?	Logical drive rebuild failed. It could result from one of the following reasons: <ol style="list-style-type: none"> 1. The rebuild has been canceled by user. 2. The drive used for rebuild might have failed during rebuild. 3. Bad blocks are encountered on another member drive during the rebuild. 4. System faults occurred. 		
What to Do?	Carefully identify and replace the faulty drive and perform logical drive initialization again.		

Terminal	LG:_ Logical Drive ALERT: CHL:_ ID:_ Clone Failed		
Event Type	<input checked="" type="checkbox"/> Alert	<input type="checkbox"/> Warning	<input type="checkbox"/> Notification
What Happens?	Drive cloning failed. It could result from one of the following reasons: <ol style="list-style-type: none"> 1. Cloning has been canceled by user. 2. The drive used for cloning might have failed during rebuild. 3. Bad blocks are encountered on another member drive during the cloning. 4. System faults occurred. 		
What to Do?	Carefully identify and replace the faulty drive and perform drive cloning again.		

Terminal	LG:_ ALERT: Inconsistent Parity Encountered Block _____		
Event Type	<input checked="" type="checkbox"/> Alert	<input type="checkbox"/> Warning	<input type="checkbox"/> Notification
What Happens?	Parity inconsistency encountered on block address _____.		
What to Do?	Nay perform regenerate parity function to correct the parity faults.		

Notification:

Terminal	Creation of Logical Drive_ Completed		
Event Type	<input type="checkbox"/> Alert	<input type="checkbox"/> Warning	<input checked="" type="checkbox"/> Notification
What Happens?	Creation of logical drive completed; the initialization may take place some time later if on-line mode is chosen.		
What to Do?	Press <ESC> to clear the message.		

Terminal	LG:_ Logical Drive NOTICE: Add Drive Operation Paused		
Event Type	<input type="checkbox"/> Alert	<input type="checkbox"/> Warning	<input checked="" type="checkbox"/> Notification
What Happens?	The add drive expansion process is halted by: <ol style="list-style-type: none"> 1. Logical drive expansion canceled by user. 2. On of the member drives failed during logical drive initialization. 3. One of the member drive encountered bad block 		

4. Hardware failure	
<i>What to Do?</i>	If the target logical drive has failed, try to rebuild the logical drive.
<i>Terminal Event Type</i>	LG:_ Logical Drive NOTICE: Continue Add Drive Operation <input type="checkbox"/> Alert <input type="checkbox"/> Warning <input checked="" type="checkbox"/> Notification
<i>What Happens?</i>	The target logical drive has been restored to its previous status, and the add drive operation may continue.
<i>What to Do?</i>	Press <ESC> to clear the message.
<i>Terminal Event Type</i>	LG:_ Logical Drive NOTICE: Continue Parity Regeneration Operation <input type="checkbox"/> Alert <input type="checkbox"/> Warning <input checked="" type="checkbox"/> Notification
<i>What Happens?</i>	The target logical drive has been restored to its previous status, and the regeneration operation can continue.
<i>What to Do?</i>	Press <ESC> to clear the message.
<i>Terminal Event Type</i>	LG:_ Logical Drive NOTICE: Continue Parity Rebuild Operation <input type="checkbox"/> Alert <input type="checkbox"/> Warning <input checked="" type="checkbox"/> Notification
<i>What Happens?</i>	The target logical drive has been restored to its previous status, and the rebuild operation can continue.
<i>What to Do?</i>	Press <ESC> to clear the message.
<i>Terminal Event Type</i>	LG_ Logical Drive NOTICE: Starting Creation <input type="checkbox"/> Alert <input type="checkbox"/> Warning <input checked="" type="checkbox"/> Notification
<i>What Happens?</i>	Logical drive initial configuration completed, starting the creation process.
<i>What to Do?</i>	Press <ESC> to clear the message.
<i>Terminal Event Type</i>	LG_ Logical Drive NOTICE: Starting Off-Line Expansion <input type="checkbox"/> Alert <input type="checkbox"/> Warning <input checked="" type="checkbox"/> Notification
<i>What Happens?</i>	Start expanding the logical drive immediately after selecting to expand.
<i>What to Do?</i>	Press <ESC> to clear the message.
<i>Terminal Event Type</i>	LG_ Logical Drive NOTICE: Starting Off-Line Initialization <input type="checkbox"/> Alert <input type="checkbox"/> Warning <input checked="" type="checkbox"/> Notification
<i>What Happens?</i>	Start initializing the logical drive immediately after creating the logical drive.
<i>What to Do?</i>	Press <ESC> to clear the message.
<i>Terminal Event Type</i>	LG_ Logical Drive NOTICE: Starting On-Line Expansion <input type="checkbox"/> Alert <input type="checkbox"/> Warning <input checked="" type="checkbox"/> Notification

<i>What Happens?</i>	Start expanding the logical drive when system find appropriate time after selecting to expand.
<i>What to Do?</i>	Press <ESC> to clear the message.
<i>Terminal</i>	LG_ Logical Drive NOTICE: Starting On-Line Initialization
<i>Event Type</i>	<input type="checkbox"/> Alert <input type="checkbox"/> Warning <input checked="" type="checkbox"/> Notification
<i>What Happens?</i>	Start initializing the logical drive immediately when system find appropriate time after creating the logical drive.
<i>What to Do?</i>	Press <ESC> to clear the message.
<i>Terminal</i>	LG=_ Logical Drive NOTICE: Starting Parity Regeneration
<i>Event Type</i>	<input type="checkbox"/> Alert <input type="checkbox"/> Warning <input checked="" type="checkbox"/> Notification
<i>What Happens?</i>	Start regenerating parity of a logical drive.
<i>What to Do?</i>	Press <ESC> to clear the message.
<i>Terminal</i>	LG_ Logical Drive NOTICE: Starting Rebuild
<i>Event Type</i>	<input type="checkbox"/> Alert <input type="checkbox"/> Warning <input checked="" type="checkbox"/> Notification
<i>What Happens?</i>	The rebuild process has begun.
<i>What to Do?</i>	This is the message displayed when a stand-by spare is available or when a faulty drive is replaced. The controller automatically detects a drive for rebuild if the hot swap check time is set.
<i>Terminal</i>	LG:_ Logical Drive NOTICE: CHL:_ ID:_ Clone Completed
<i>Event Type</i>	<input type="checkbox"/> Alert <input type="checkbox"/> Warning <input checked="" type="checkbox"/> Notification
<i>What Happens?</i>	The clone process has been completed.
<i>What to Do?</i>	Press <ESC> to clear the message. When cloning is completed, carefully identify and replace the faulty/replaced drive.
<i>Terminal</i>	LG_ Logical Drive NOTICE: CHL:_ ID:_ Copy and Replace Completed
<i>Event Type</i>	<input type="checkbox"/> Alert <input type="checkbox"/> Warning <input checked="" type="checkbox"/> Notification
<i>What Happens?</i>	Copy and Replace on drive CHL:_ ID:_ completed.
<i>What to Do?</i>	Press <ESC> to clear the message.
<i>Terminal</i>	LG_ Logical Drive NOTICE: CHL:_ ID:_ Starting Clone
<i>Event Type</i>	<input type="checkbox"/> Alert <input type="checkbox"/> Warning <input checked="" type="checkbox"/> Notification
<i>What Happens?</i>	This message is displayed when a member drive is manually cloned to a spare, or that a spare is automatically applied to clone a faulty member according to the preset scheme.
<i>What to Do?</i>	Press <ESC> to clear the message. When cloning is completed, carefully identify and replace the faulty/replaced drive.

<i>Terminal</i>	LG_ NOTICE: CHL:_ ID:_ Starting Media Scan
<i>Event Type</i>	<input type="checkbox"/> Alert <input type="checkbox"/> Warning <input checked="" type="checkbox"/> Notification
<i>What Happens?</i>	Starting Media Scan on a specific hard drive.
<i>What to Do?</i>	Press <ESC> to clear the message.

<i>Terminal</i>	LG_ NOTICE: Media Scan of CHL:_ ID:_ Completed
<i>Event Type</i>	<input type="checkbox"/> Alert <input type="checkbox"/> Warning <input checked="" type="checkbox"/> Notification
<i>What Happens?</i>	Media Scan on a specific hard drive completed.
<i>What to Do?</i>	Press <ESC> to clear the message.

<i>Terminal</i>	Off-Line Expansion of Logical Drive_ Completed
<i>Event Type</i>	<input type="checkbox"/> Alert <input type="checkbox"/> Warning <input checked="" type="checkbox"/> Notification
<i>What Happens?</i>	Logical drive expansion off-line completed.
<i>What to Do?</i>	Press <ESC> to clear the message.

<i>Terminal</i>	On-Line Expansion of Logical Drive_ Completed
<i>Event Type</i>	<input type="checkbox"/> Alert <input type="checkbox"/> Warning <input checked="" type="checkbox"/> Notification
<i>What Happens?</i>	Logical drive expansion on-line completed.
<i>What to Do?</i>	Press <ESC> to clear the message.

<i>Terminal</i>	Off-Line Initialization of Logical Drive_ Completed
<i>Event Type</i>	<input type="checkbox"/> Alert <input type="checkbox"/> Warning <input checked="" type="checkbox"/> Notification
<i>What Happens?</i>	The off-line initialization process of LG_ has been completed.
<i>What to Do?</i>	Press <ESC> to clear the message.

<i>Terminal</i>	On-Line Initialization of Logical Drive_ Completed
<i>Event Type</i>	<input type="checkbox"/> Alert <input type="checkbox"/> Warning <input checked="" type="checkbox"/> Notification
<i>What Happens?</i>	The on-line initialization process of LG_ has been completed.
<i>What to Do?</i>	Press <ESC> to clear the message.

<i>Terminal</i>	Parity Regeneration of Logical Drive_ Completed
<i>Event Type</i>	<input type="checkbox"/> Alert <input type="checkbox"/> Warning <input checked="" type="checkbox"/> Notification
<i>What Happens?</i>	The parity regeneration process on logical drive_ completed.
<i>What to Do?</i>	Press <ESC> to clear the message.

Do?

Terminal Rebuild of Logical Drive_ Completed

Event Type Alert Warning Notification

What Happens? The controller/subsystem has successfully rebuilt a logical drive.

What to Do? Press <ESC> to clear the message.

Terminal Add Drive to Logical Drive_ Completed

Event Type Alert Warning Notification

What Happens? The expansion "by adding new drive" is completed.

What to Do? Press <ESC> to clear the message.

Terminal NOTICE: CHL:_ ID:_ Starting Media Scan

Event Type Alert Warning Notification

What Happens? Media Scan started on drive CHL:_ ID:_.

What to Do? Press <ESC> to clear the message.

General Target Events:

Alert:

SAF-TE Devices:

<i>Terminal</i>	SAF-TE Device () ALERT: Cooling Fan Failure Detected ()		
<i>Event Type</i>	<input checked="" type="checkbox"/> Alert	<input type="checkbox"/> Warning	<input type="checkbox"/> Notification
<i>What Happens?</i>	The cooling fan has failed.		
<i>What to Do?</i>	Contact your system supplier for a replacement and further diagnosis.		

<i>Terminal</i>	SAF-TE Device () ALERT: Cooling Fan Not Installed ()		
<i>Event Type</i>	<input checked="" type="checkbox"/> Alert	<input type="checkbox"/> Warning	<input type="checkbox"/> Notification
<i>What Happens?</i>	The installed fan once installed () is missing.		
<i>What to Do?</i>	See if the fan has been removed or a general failure has occurred. Contact your system supplier.		

<i>Terminal</i>	SAF-TE Device () ALERT: Power Supply Failure Detected ()		
<i>Event Type</i>	<input checked="" type="checkbox"/> Alert	<input type="checkbox"/> Warning	<input type="checkbox"/> Notification
<i>What Happens?</i>	Power supply failure detected by SAF-TE enclosure management.		
<i>What to Do?</i>	Check the power supply module, contact your RAID system supplier.		

<i>Terminal</i>	SAF-TE Device () ALERT: Elevated Temperature Alert ()		
<i>Event Type</i>	<input checked="" type="checkbox"/> Alert	<input type="checkbox"/> Warning	<input type="checkbox"/> Notification
<i>What Happens?</i>	High temperature detected.		
<i>What to Do?</i>	High temperature may lead to malfunctioning and system failure. The most probable cause is the cooling system failure. Contact your system provider immediately.		

<i>Terminal</i>	SAF-TE Device () ALERT: UPS Power Failure Detected ()		
<i>Event Type</i>	<input checked="" type="checkbox"/> Alert	<input type="checkbox"/> Warning	<input type="checkbox"/> Notification
<i>What Happens?</i>	UPS Power Failure.		
<i>What to Do?</i>	If UPS protection is lost, inconsistency may occur to cached data upon power interruption. Auto-switch to write-through cache upon the detection of UPS failure will be activated if this option has been enabled. Check connection with the UPS and contact your system provider for help.		

RAID Controller:

<i>Terminal</i>	Peripheral Device ALERT: CPU Temperature <high/low threshold> Temperature Detected (._.C)		
<i>Event Type</i>	<input checked="" type="checkbox"/> Alert	<input type="checkbox"/> Warning	<input type="checkbox"/> Notification
<i>What Happens?</i>	The detected CPU temperature is higher or lower than the preset threshold.		
<i>What to Do?</i>	Check the enclosure ventilation condition. If necessary, temperature thresholds can be modified to suit different working conditions.		

<i>Terminal</i>	Peripheral Device ALERT: Temperature <Elevated/Low> Temperature Alert (._.C)		
<i>Event Type</i>	<input checked="" type="checkbox"/> Alert	<input type="checkbox"/> Warning	<input type="checkbox"/> Notification
<i>What Happens?</i>	The detected main circuit board temperature is higher or lower than the preset threshold.		
<i>What to Do?</i>	Check the enclosure ventilation condition. If necessary, temperature thresholds can be modified to suit different working conditions.		

<i>Terminal</i>	BBU Absent or Failed!Correct It and Reset Ctlr to Take Effect		
<i>Event Type</i>	<input checked="" type="checkbox"/> Alert	<input type="checkbox"/> Warning	<input type="checkbox"/> Notification
<i>What Happens?</i>	As the message suggests.		
<i>What to Do?</i>	BBU is not a field replaceable module, contact your system provider for a replacement.		

<i>Terminal</i>	Controller FAN_ <high/low threshold> Speed Detected (._RPM)		
<i>Event Type</i>	<input checked="" type="checkbox"/> Alert	<input type="checkbox"/> Warning	<input type="checkbox"/> Notification
<i>What Happens?</i>	This event refers to the cooling fan in front panel. Higher or Lower rotation speed detected.		
<i>What to Do?</i>	Contact your system vendor for replacing the cooling fan if necessary.		

<i>Terminal</i>	+3.3V <upper/lower threshold> Voltage Detected (.)		
<i>Event Type</i>	<input checked="" type="checkbox"/> Alert	<input type="checkbox"/> Warning	<input type="checkbox"/> Notification
<i>What Happens?</i>	The detected +3.3V voltage source is now higher or lower than the preset voltage threshold.		
<i>What to Do?</i>	Check power supply condition, voltage threshold settings and contact the your system supplier.		

<i>Terminal</i>	Peripheral Device ALERT: Controller FAN_ Not Present or Failure Detected		
<i>Event Type</i>	<input checked="" type="checkbox"/> Alert	<input type="checkbox"/> Warning	<input type="checkbox"/> Notification
<i>What Happens?</i>	This event refers to the cooling fan in front panel. Check cable connection and see if the fan(s) has failed.		
<i>What to Do?</i>	Check cable connection and see if the fan(s) is rotating. Some OEM solutions may have removed front panel fans and the "fan detect" signals should be disabled by setting related jumpers. Please refer to		

your Hardware Manual for more details.

<i>Terminal</i>	Peripheral Device ALERT: +5V <upper/lower threshold> Voltage Detected (_)
<i>Event Type</i>	<input checked="" type="checkbox"/> Alert <input type="checkbox"/> Warning <input type="checkbox"/> Notification
<i>What Happens?</i>	The detected +5V voltage source is now higher or lower than the preset voltage threshold.
<i>What to Do?</i>	Check power supply condition, voltage threshold settings and contact your system supplier.

<i>Terminal</i>	Peripheral Device ALERT: +12V <upper/lower> Voltage Detected (_)
<i>Event Type</i>	<input checked="" type="checkbox"/> Alert <input type="checkbox"/> Warning <input type="checkbox"/> Notification
<i>What Happens?</i>	The detected +12V voltage source is higher or lower than the preset voltage threshold.
<i>What to Do?</i>	Check power supply condition, voltage threshold settings and contact your system supplier.

Enclosure Devices:

<i>Terminal</i>	Peripheral Set_ Device ALERT: Cold Temperature_ Detected (_ _ C)
<i>Event Type</i>	<input checked="" type="checkbox"/> Alert <input type="checkbox"/> Warning <input type="checkbox"/> Notification
<i>What Happens?</i>	The designated temperature sensor has detected temperature lower than preset threshold. This may be caused by mistakes with device target setting or extreme environmental condition.
<i>What to Do?</i>	Check device target setting and improve condition of the installation site.

<i>Terminal</i>	Peripheral Set_ Device ALERT: FAN_ Failure Detected
<i>Event Type</i>	<input checked="" type="checkbox"/> Alert <input type="checkbox"/> Warning <input type="checkbox"/> Notification
<i>What Happens?</i>	Cooling fan failure detected by enclosure management.
<i>What to Do?</i>	Check cooling fan(s) status, and contact your system supplier.

<i>Terminal</i>	Peripheral Set_ Device ALERT: FAN_ Not Present
<i>Event Type</i>	<input checked="" type="checkbox"/> Alert <input type="checkbox"/> Warning <input type="checkbox"/> Notification
<i>What Happens?</i>	The controller failed to detect the presence of the designated cooling fan.
<i>What to Do?</i>	Check enclosure connection, peripheral device setting, fan module, and contact your system supplier.

<i>Terminal</i>	Peripheral Set_ Device ALERT: <high/low threshold> Fan_ Speed Detected (_ RPM)
<i>Event Type</i>	<input checked="" type="checkbox"/> Alert <input type="checkbox"/> Warning <input type="checkbox"/> Notification

<i>What Happens?</i>	Enclosure fan higher or lower rotation speed detected.
<i>What to Do?</i>	Contact your system vendor for a replacement fan.
<i>Terminal</i>	Peripheral Set_ Device ALERT: <high/low threshold> Power Supply_ Voltage Detected (._V)
<i>Event Type</i>	<input checked="" type="checkbox"/> Alert <input type="checkbox"/> Warning <input type="checkbox"/> Notification
<i>What Happens?</i>	Voltage exceeding preset thresholds
<i>What to Do?</i>	Contact your system supplier.
<i>Terminal</i>	Peripheral Set_ Device ALERT: Temperature Sensor_ Failure Detected
<i>Event Type</i>	<input checked="" type="checkbox"/> Alert <input type="checkbox"/> Warning <input type="checkbox"/> Notification
<i>What Happens?</i>	The designated temperature sensor has failed. This may be caused by mistakes with device target setting or a device failure.
<i>What to Do?</i>	Check device set connection and contact your system supplier.
<i>Terminal</i>	Peripheral Set_ Device ALERT: Power Supply_ Failure Detected
<i>Event Type</i>	<input checked="" type="checkbox"/> Alert <input type="checkbox"/> Warning <input type="checkbox"/> Notification
<i>What Happens?</i>	Power supply failure detected.
<i>What to Do?</i>	Contact your system provider for help.
<i>Terminal</i>	Peripheral Set_ Device ALERT: Power Supply_ Not Present
<i>Event Type</i>	<input checked="" type="checkbox"/> Alert <input type="checkbox"/> Warning <input type="checkbox"/> Notification
<i>What Happens?</i>	Could not detect power supply.
<i>What to Do?</i>	Check device set connection, peripheral device setting, and contact your system supplier.
<i>Terminal</i>	Peripheral Set_ Device ALERT: UPS_ AC Power Failure Detected
<i>Event Type</i>	<input checked="" type="checkbox"/> Alert <input type="checkbox"/> Warning <input type="checkbox"/> Notification
<i>What Happens?</i>	UPS power failure.
<i>What to Do?</i>	If UPS protection is lost, inconsistency may occur to cached data upon power interruption. Contact your system provider for help.
<i>Terminal</i>	Peripheral Device ALERT: UPS_ Battery Failure Detected
<i>Event Type</i>	<input checked="" type="checkbox"/> Alert <input type="checkbox"/> Warning <input type="checkbox"/> Notification
<i>What Happens?</i>	UPS battery failure.
<i>What to Do?</i>	If UPS protection is lost, inconsistency may occur to cached data upon power interruption. Contact your system provider for help.

<i>Terminal</i>	UPS Connection Is Absent
<i>Event Type</i>	<input checked="" type="checkbox"/> Alert <input type="checkbox"/> Warning <input type="checkbox"/> Notification
<i>What Happens?</i>	The diagnose line RS-232C connection from UPS to your array is lost.
<i>What to Do?</i>	Check RS-232C cable connection and UPS working status, and contact your system supplier if the fault can not be corrected.

SES Devices:

<i>Terminal</i>	SES (C_I_) Power Supply_: <Vendor descriptor strings/Device Not Supported>!
<i>Event Type</i>	<input checked="" type="checkbox"/> Alert <input type="checkbox"/> Warning <input type="checkbox"/> Notification
<i>What Happens?</i>	Unrecognizable device type.
<i>What to Do?</i>	Press <ESC> to clear the message.

<i>Terminal</i>	SES (C_I_) Power Supply_: <Vendor descriptor strings/Device Not Installed>!
<i>Event Type</i>	<input checked="" type="checkbox"/> Alert <input type="checkbox"/> Warning <input type="checkbox"/> Notification
<i>What Happens?</i>	The installed power supply is missing.
<i>What to Do?</i>	Check loop connection and contact your system provider for help.

<i>Terminal</i>	SES (C_I_) Power Supply_: <Vendor descriptor strings/Device Unknown Status>!
<i>Event Type</i>	<input checked="" type="checkbox"/> Alert <input type="checkbox"/> Warning <input type="checkbox"/> Notification
<i>What Happens?</i>	Device reports unknown status strings.
<i>What to Do?</i>	Check loop connection and contact your system provider for help.

<i>Terminal</i>	SES (C_I_) Cooling Fan_: <Vendor descriptor strings/Device Not Supported>!
<i>Event Type</i>	<input checked="" type="checkbox"/> Alert <input type="checkbox"/> Warning <input type="checkbox"/> Notification
<i>What Happens?</i>	Unrecognizable device type
<i>What to Do?</i>	Check loop connection and contact your system provider for help.

<i>Terminal</i>	SES (C_I_) Cooling Fan_: <Vendor descriptor strings/Device Not Installed>!
<i>Event Type</i>	<input checked="" type="checkbox"/> Alert <input type="checkbox"/> Warning <input type="checkbox"/> Notification
<i>What Happens?</i>	The installed device is missing
<i>What to Do?</i>	Check loop connection and contact your system provider for help.

Do?

Terminal SES (C_I_) Cooling element_: <Vendor descriptor strings/Device Unknown Status>!

Event Type Alert Warning Notification

What Happens? Device reports unknown status strings.

What to Do? Press <ESC> to clear the message.

Terminal SES (C_I_) Temperature Sensor_: <Vendor descriptor strings/Device Not Supported>!

Event Type Alert Warning Notification

What Happens? Unrecognizable device type.

What to Do? Press <ESC> to clear the message.

Terminal SES (C_I_) Temperature Sensor_: <Vendor descriptor strings/Device Not Installed>!

Event Type Alert Warning Notification

What Happens? The installed device is missing.

What to Do? Press <ESC> to clear the message.

Terminal SES (C_I_) Temperature Sensor_: <Vendor descriptor strings/Device Unknown Status>!

Event Type Alert Warning Notification

What Happens? Device reports unknown status strings.

What to Do? Press <ESC> to clear the message.

Terminal SES (C_I_) UPS_: <Vendor descriptor strings/Device Not Supported>!

Event Type Alert Warning Notification

What Happens? Unrecognizable device type.

What to Do? Press <ESC> to clear the message.

Terminal SES (C_I_) UPS_: <Vendor descriptor strings/Device Not Installed>!

Event Type Alert Warning Notification

What Happens? The installed device is missing.

What to Do? Press <ESC> to clear the message.

Terminal SES (C_I_) UPS_: <Vendor descriptor strings/Device Unknown

	Status>!			
<i>Event Type</i>	<input checked="" type="checkbox"/> Alert	<input type="checkbox"/> Warning	<input type="checkbox"/> Notification	
<i>What Happens?</i>	Device reports unknown status strings.			
<i>What to Do?</i>	Press <ESC> to clear the message.			
<i>Terminal</i>	SES (C_I_) Voltage Sensor_: <Vendor descriptor strings/Device Not Supported>!			
<i>Event Type</i>	<input checked="" type="checkbox"/> Alert	<input type="checkbox"/> Warning	<input type="checkbox"/> Notification	
<i>What Happens?</i>	Unrecognizable device type.			
<i>What to Do?</i>	Press <ESC> to clear the message.			
<i>Terminal</i>	SES (C_I_) Voltage Sensor_: <Vendor descriptor strings/Device Not Installed>!			
<i>Event Type</i>	<input checked="" type="checkbox"/> Alert	<input type="checkbox"/> Warning	<input type="checkbox"/> Notification	
<i>What Happens?</i>	The installed device is missing.			
<i>What to Do?</i>	Press <ESC> to clear the message.			
<i>Terminal</i>	SES (C_I_) Voltage Sensor_: <Vendor descriptor strings/Device Unknown Status>!			
<i>Event Type</i>	<input checked="" type="checkbox"/> Alert	<input type="checkbox"/> Warning	<input type="checkbox"/> Notification	
<i>What Happens?</i>	Device reports unknown status strings.			
<i>What to Do?</i>	Press <ESC> to clear the message.			
<i>Terminal</i>	SES (C_I_) Current Sensor_: <Vendor descriptor strings/Device Not Supported>!			
<i>Event Type</i>	<input checked="" type="checkbox"/> Alert	<input type="checkbox"/> Warning	<input type="checkbox"/> Notification	
<i>What Happens?</i>	Unrecognizable device type.			
<i>What to Do?</i>	Press <ESC> to clear the message.			
<i>Terminal</i>	SES (C_I_) Current Sensor_: <Vendor descriptor strings/Device Not Installed>!			
<i>Event Type</i>	<input checked="" type="checkbox"/> Alert	<input type="checkbox"/> Warning	<input type="checkbox"/> Notification	
<i>What Happens?</i>	The installed device is missing.			
<i>What to Do?</i>	Press <ESC> to clear the message.			
<i>Terminal</i>	SES (C_I_) Current Sensor_: <Vendor descriptor strings/Device Unknown Status>!			

<i>Event Type</i>	<input checked="" type="checkbox"/> Alert	<input type="checkbox"/> Warning	<input type="checkbox"/> Notification
<i>What Happens?</i>	Device reports unknown status strings.		
<i>What to Do?</i>	Press <ESC> to clear the message.		

General Peripheral Devices:

<i>Terminal</i>	ALERT: UPS AC Power-Loss Detected		
<i>Event Type</i>	<input checked="" type="checkbox"/> Alert	<input type="checkbox"/> Warning	<input type="checkbox"/> Notification
<i>What Happens?</i>	Mains power is interrupted.		
<i>What to Do?</i>	Controller/subsystem can be configured to commence an auto cache flush upon the detection of mains power. See Event Triggered operation.		

<i>Terminal</i>	[3f21] Peripheral Device ALERT: Power Supply Failure Detected		
<i>Event Type</i>	<input checked="" type="checkbox"/> Alert	<input type="checkbox"/> Warning	<input type="checkbox"/> Notification
<i>What Happens?</i>	Power supply failure detected		
<i>What to Do?</i>	Press <ESC> to clear the message.		

<i>Terminal</i>	[3f22] Cooling Fan Not Installed		
<i>Event Type</i>	<input checked="" type="checkbox"/> Alert	<input type="checkbox"/> Warning	<input type="checkbox"/> Notification
<i>What Happens?</i>			
<i>What to Do?</i>	Press <ESC> to clear the message.		

<i>Terminal</i>	[3f22] Cooling Fan Failure Detected		
<i>Event Type</i>	<input checked="" type="checkbox"/> Alert	<input type="checkbox"/> Warning	<input type="checkbox"/> Notification
<i>What Happens?</i>			
<i>What to Do?</i>	Press <ESC> to clear the message.		

<i>Terminal</i>	[3f24] Elevated Temperature Alert		
<i>Event Type</i>	<input checked="" type="checkbox"/> Alert	<input type="checkbox"/> Warning	<input type="checkbox"/> Notification
<i>What Happens?</i>			
<i>What to Do?</i>	Press <ESC> to clear the message.		

Notification:

SAF-TE Devices:

<i>Terminal</i>	[3fa2] SAF-TE () NOTICE: Fan Back On-Line
<i>Event Type</i>	<input type="checkbox"/> Alert <input type="checkbox"/> Warning <input checked="" type="checkbox"/> Notification
<i>What Happens?</i>	Failed fan back to on-line state.
<i>What to Do?</i>	Press <ESC> to clear the message.
<i>Terminal</i>	[3fa3] SAF-TE Device () NOTICE: Temperature Back to Non-Critical Levels ()
<i>Event Type</i>	<input type="checkbox"/> Alert <input type="checkbox"/> Warning <input checked="" type="checkbox"/> Notification
<i>What Happens?</i>	Temperature back to non-critical level.
<i>What to Do?</i>	Press <ESC> to clear the message.
<i>Terminal</i>	[3fa1] SAF-TE Device () NOTICE: Power Supply Back On-Line ()
<i>Event Type</i>	<input type="checkbox"/> Alert <input type="checkbox"/> Warning <input checked="" type="checkbox"/> Notification
<i>What Happens?</i>	Power supply restored.
<i>What to Do?</i>	Press <ESC> to clear the message.
<i>Terminal</i>	[3fa4] SAF-TE Device () NOTICE: UPS Power Back On-Line
<i>Event Type</i>	<input type="checkbox"/> Critical <input type="checkbox"/> Warning <input checked="" type="checkbox"/> Notification
<i>What Happens?</i>	UPS power restored..
<i>What to Do?</i>	Press <ESC> to clear the message.

Controller Self-Diagnostics:

<i>Terminal</i>	[3fa3] CPU <high/low threshold> Temperature Back to Non-Critical Levels
<i>Event Type</i>	<input type="checkbox"/> Critical <input type="checkbox"/> Warning <input checked="" type="checkbox"/> Notification
<i>What Happens?</i>	CPU operating temperature back to non-critical level.
<i>What to Do?</i>	Press <ESC> to clear the message.
<i>Terminal</i>	[3fa3] Board_ <high/low> Temperature Back To Non-Critical Levels
<i>Event Type</i>	<input type="checkbox"/> Critical <input type="checkbox"/> Warning <input checked="" type="checkbox"/> Notification
<i>What Happens?</i>	Board_ temperature back to non-critical level.
<i>What to Do?</i>	Press <ESC> to clear the message.
<i>Terminal</i>	[3fa1] +3.3V <high/low> Voltage Back within Acceptable Limits
<i>Event Type</i>	<input type="checkbox"/> Critical <input type="checkbox"/> Warning <input checked="" type="checkbox"/> Notification
<i>What Happens?</i>	+3.3V voltage source back within acceptable limits.
<i>What to Do?</i>	Press <ESC> to clear the message.
<i>Terminal</i>	[3fa1] +5V <high/low> Voltage Back within Acceptable Limits
<i>Event Type</i>	<input type="checkbox"/> Critical <input type="checkbox"/> Warning <input checked="" type="checkbox"/> Notification
<i>What Happens?</i>	+5V voltage source back within acceptable limits.
<i>What to Do?</i>	Press <ESC> to clear the message.
<i>Terminal</i>	[3fa1] +12V <high/low> Voltage Back within Acceptable Limits
<i>Event Type</i>	<input type="checkbox"/> Critical <input type="checkbox"/> Warning <input checked="" type="checkbox"/> Notification
<i>What Happens?</i>	+12V voltage source back within acceptable limits.
<i>What to Do?</i>	Press <ESC> to clear the message.
<i>Terminal</i>	[3fa2] NOTICE: Controller FAN_ Back On-Line (_RPM)
<i>Event Type</i>	<input type="checkbox"/> Alert <input type="checkbox"/> Warning <input checked="" type="checkbox"/> Notification
<i>What Happens?</i>	Controller fan operating status back to normal
<i>What to Do?</i>	Press <ESC> to clear the message.

PC Device:

<i>Terminal</i>	[3fa3] NOTICE: Temperature_ Back to Non-Critical Levels
-----------------	---

<i>Event Type</i>	<input type="checkbox"/> Alert	<input type="checkbox"/> Warning	<input checked="" type="checkbox"/> Notification
<i>What Happens?</i>	Detected temperature back to non-critical levels.		
<i>What to Do?</i>	Press <ESC> to clear the message.		

<i>Terminal</i>	[3fa3] NOTICE: Temperature_ is present		
<i>Event Type</i>	<input type="checkbox"/> Alert	<input type="checkbox"/> Warning	<input checked="" type="checkbox"/> Notification
<i>What Happens?</i>	Temperature sensor_ detected.		
<i>What to Do?</i>	Press <ESC> to clear the message.		

<i>Terminal</i>	[3fa2] NOTICE: FAN_ Back On-Line		
<i>Event Type</i>	<input type="checkbox"/> Alert	<input type="checkbox"/> Warning	<input checked="" type="checkbox"/> Notification
<i>What Happens?</i>	FAN_ back online.		
<i>What to Do?</i>	Press <ESC> to clear the message.		

<i>Terminal</i>	[3fa2] NOTICE: FAN_ is present		
<i>Event Type</i>	<input type="checkbox"/> Alert	<input type="checkbox"/> Warning	<input checked="" type="checkbox"/> Notification
<i>What Happens?</i>	FAN_ detected.		
<i>What to Do?</i>	Press <ESC> to clear the message.		

<i>Terminal</i>	[3fa1] NOTICE: Power Supply_ Back On-Line		
<i>Event Type</i>	<input type="checkbox"/> Alert	<input type="checkbox"/> Warning	<input checked="" type="checkbox"/> Notification
<i>What Happens?</i>	Power supply back online.		
<i>What to Do?</i>	Press <ESC> to clear the message.		

<i>Terminal</i>	[3fa1] NOTICE: Power Supply_ is present		
<i>Event Type</i>	<input type="checkbox"/> Alert	<input type="checkbox"/> Warning	<input checked="" type="checkbox"/> Notification
<i>What Happens?</i>	Power supply_ detected.		
<i>What to Do?</i>	Press <ESC> to clear the message.		

<i>Terminal</i>	[3fa4] Peripheral Device NOTICE: UPS_ AC Power Back On-Line		
<i>Event Type</i>	<input type="checkbox"/> Alert	<input type="checkbox"/> Warning	<input checked="" type="checkbox"/> Notification
<i>What Happens?</i>	UPS_ AC Power Back On-Line.		
<i>What to Do?</i>	Press <ESC> to clear the message.		

<i>Terminal</i>	[3fa4] Peripheral Device NOTICE: UPS_ Battery Back On-Line		
-----------------	--	--	--

<i>Event Type</i>	<input type="checkbox"/> Alert	<input type="checkbox"/> Warning	<input checked="" type="checkbox"/> Notification
<i>What Happens?</i>	UPS_ battery back online.		
<i>What to Do?</i>	Press <ESC> to clear the message.		

SES Device:

Alert:

<i>Terminal</i>	[3f21] SES (C_I_) Power Supply_: Power Supply Failure Detected		
<i>Event Type</i>	<input checked="" type="checkbox"/> Alert	<input type="checkbox"/> Warning	<input type="checkbox"/> Notification
<i>What Happens?</i>	Power supply failure detected.		
<i>What to Do?</i>	Check power module status and contact your supplier for a replacement unit.		

<i>Terminal</i>	[3f22] SES (C_I_) Cooling element_: Cooling Fan Not Installed		
<i>Event Type</i>	<input checked="" type="checkbox"/> Alert	<input type="checkbox"/> Warning	<input type="checkbox"/> Notification
<i>What Happens?</i>	Cooling fan missing or not detected.		
<i>What to Do?</i>	Check proper fan installation or contact your supplier to replace a failed unit.		

<i>Terminal</i>	[3f22] SES (C_I_) Cooling element_: Cooling Fan Failure Detected		
<i>Event Type</i>	<input checked="" type="checkbox"/> Alert	<input type="checkbox"/> Warning	<input type="checkbox"/> Notification
<i>What Happens?</i>	Contact your system provider for an immediate replacement of fan modules.		
<i>What to Do?</i>	Contact your system provider for an immediate replacement of fan modules.		

<i>Terminal</i>	[3f23] SES (C_I_) Temperature Sensor_: Elevated Temperature Alert		
<i>Event Type</i>	<input checked="" type="checkbox"/> Alert	<input type="checkbox"/> Warning	<input type="checkbox"/> Notification
<i>What Happens?</i>	Detected temperature exceeding safety range.		
<i>What to Do?</i>	Check cooling fan status. Contact your system provider for an immediate replacement of fan modules.		

<i>Terminal</i>	[3f24] SES (C_I_) UPS_: UPS Power Failure Detected		
<i>Event Type</i>	<input checked="" type="checkbox"/> Alert	<input type="checkbox"/> Warning	<input type="checkbox"/> Notification
<i>What Happens?</i>	UPS power failure detected.		
<i>What to Do?</i>	Check UPS status. If power should fail and UPS is not able to sustain power, data loss might occur.		

General Peripheral Device:

<i>Terminal</i>	[3f21] Peripheral Device ALERT: Power Supply Failure Detected
<i>Event Type</i>	<input checked="" type="checkbox"/> Alert <input type="checkbox"/> Warning <input type="checkbox"/> Notification
<i>What Happens?</i>	Power Supply Failure Detected.
<i>What to Do?</i>	Check power module status and contact your supplier for a replacement unit.
<hr/>	
<i>Terminal</i>	[3f22] Cooling Fan Not Installed
<i>Event Type</i>	<input checked="" type="checkbox"/> Alert <input type="checkbox"/> Warning <input type="checkbox"/> Notification
<i>What Happens?</i>	Cooling fan missing or not detected.
<i>What to Do?</i>	Check proper fan installation or contact your supplier to replace a failed unit.
<hr/>	
<i>Terminal</i>	[3f22] Cooling Fan_ Failure Detected
<i>Event Type</i>	<input checked="" type="checkbox"/> Alert <input type="checkbox"/> Warning <input type="checkbox"/> Notification
<i>What Happens?</i>	Cooling fan failure detected.
<i>What to Do?</i>	Contact your system provider for an immediate replacement of fan modules.
<hr/>	
<i>Terminal</i>	[3f24] Elevated Temperature Alert
<i>Event Type</i>	<input checked="" type="checkbox"/> Alert <input type="checkbox"/> Warning <input type="checkbox"/> Notification
<i>What Happens?</i>	General overheating warning.
<i>What to Do?</i>	Check cooling fan status and proper installation of dummy plate. Consult your enclosure vendor's document for probable cause.
<hr/>	
<i>Terminal</i>	[3f24] UPS Power Failure Detected
<i>Event Type</i>	<input checked="" type="checkbox"/> Alert <input type="checkbox"/> Warning <input type="checkbox"/> Notification
<i>What Happens?</i>	UPS device failure detected.
<i>What to Do?</i>	Check UPS status. If power should fail and UPS is not able to sustain power, data loss might occur.

Index

2nd drive failure, A-2

A

Abort clone, 15-4
AC power loss, 11-3
Access Control, 3-8, 8-16
Access Mode Read Only or Read/Write, 8-21
Access Mode, 8-21
Active-to-Active Configuration, 12-12, 12-18
Active-to-Standby Configuration, 12-18
Adaptive Write Policy, 7-5, A-5
Add Drive Procedure, 14-4
Add from current device list, 8-19
Added Capacity, 14-2, 14-4
Adding a Channel's ID, 5-26
adding a schedule, 11-14
Adding a SCSI ID, 7-28
Adjust LCD Contrast, 5-39, 7-40
Advanced Configurations, 15-1
Advanced Features, A-3
Advanced Maintenance, B-5
advantages of RAID, 1-1
All undefined LUNs, 9-4
alternate path, 11-8
ANSI Mode, 6-1
ANSI/VT-100, B-4
ANSI+Color Mode, 6-2
Array Configuration, 2-12
Array Expansion, 14-1

array write policy, 7-9
Assign Spare Drives terminal, 7-8
Assigning a Logical Drive Name, 5-18
Assigning a Logical Drive to Secondary Controller, 12-24
Assigning Logical Drive Name terminal, 7-19
Assigning Logical Drives to Secondary Controller, 12-30
Assigning Spare Drive LCD, 5-14, 7-17
ATTEN LED, 12-26
Auto cache flush, A-3
Auto recovery from logical drive failure, A-2
Auto Shutdown, 11-3
Auto-Assign Global Spare Drive, 11-12
Autocfg, 12-17, 12-21~22
Autoconfig, 12-19, 12-21
Autoconfigure Mode, 12-29
Autoconfigure, 12-28
Auto-Detect Failure Drive Swap Check Time, 7-20
Auto-Failback, 12-12
Auto-Flush, 10-5
Automatic engagement of replacement controller, A-9
Automatic Rebuild, 1-9
Automatic Shutdown, A-10
Auto-rebuild onto spare, A-2
Auto-rebuild, A-2
Auto-scan of replacement drive, A-2
Auto-Shutdown, 10-5
AV Applications, 16-1

B

Background Download, B-1
Background firmware download, A-2
Bad block auto-reassignment, A-10
Bad Block Handling, A-3
Basic RAID Management, A-1
battery backup, 12-17
battery charge, 6-2

Battery Support, 12-18
battery, A-9
Baud rate, 3-1
BBU low, 11-2
beeper mute, 5-36, 7-37
block LBA, 5-20
block number, 5-5, 7-7
Boot Record Binary, B-2
Boot Record, B-1, B-3, B-5

C

Cabling Failure, 5-35, 7-36, 11-5
Cabling Requirements Redundant config., 12-15
Cache Dirty Percentage, 4-7
cache parameters, 5-2, 7-1~2
Cache Status, 6-1~2
Cache Synchronization on Write-Through, 12-36
Cache Synchronization, 12-18
cache, 7-2
Caching Mode Dynamic Switch, A-3
caching mode, 7-5
Caching Optimization, A-5
Caching Parameters, LCD, 5-1
Caching Parameters, terminal, 7-1
Caching Parameters, 10-3, 11-2
Caching Parameters, 5-1, 5-3~4
Change Password, 5-36
Change Password, LCD, 5-36
Change Password, terminal, 7-37
changing password, 5-36, 7-37
Channel Bus Redundant config, 12-9
Channel failure protection, 1-13
channel ID, deleting, 5-27
channel ID, setting, 5-26
Channel Mode Fibre, 8-7
channel mode viewing and redefining, 5-25, 7-27

Channel Mode, A-7
channel terminator, 5-28
channel-ID combination, 8-18
channels, viewing and editing, 7-27
Choosing Member Drives LCD, 5-6, 7-8
Choosing Member Drives, 5-6
Choosing RAID Level, 7-7
clone drive, 15-3, 15-6
Clone Failing Drive, 15-1~2, A-10
Clone & Replace, 15-6
cloning progress, 15-9
Co-existing spares, A-2
COM port, B-1
commands, pass-through, 5-22
Communication Parameters, 3-6
Communications Channel, Fibre, 8-8
Communications Channel, 12-15, 12-35
Communications Loops, 8-14, 12-4
communications path, 12-29
Communications traffic distributed over all drive loops, 8-14
Concurrent Rebuild, 1-11, A-2
Configurable parameters redundant controller, 12-2
Configuration Flowchart redundant controller, 12-20
Configuration on Disk, A-4
Connection Type, 8-11
Continuous Sync, 5-4, 7-5, A-5
Controller Behaviors, 12-17, 12-32
Controller Communications Over Fibre Loops, 8-14
Controller Date and Time, 5-41, 7-44
Controller Failover and Failback, 12-9
Controller Failover, 12-11
Controller Failure, 11-2, 12-14, 12-26, 12-32
Controller Initialization, 11-14
Controller Maintenance, 5-38, B-5
Controller Name, 5-40, 6-1, 7-40
controller naming, 7-40~41

Controller Parameter Settings Fault Management, 2-10
 Controller Parameter Settings Fibre Channel Parameters, 2-10
 Controller Parameter Settings Optimization Mode, 2-10
 Controller Parameter Settings SCSI Parameters, 2-10
 Controller Parameter Settings Spin-Up Parameters, 2-10
 Controller Parameter Settings, 2-10
 Controller Parameters, 5-40, 7-40, 12-21
 Controller Peripheral Device Configuration, 10-6
 controller reset, 5-37, 7-39
 Controller Self-Monitoring, 10-5
 Controller Settings Redundant config, 12-16
 controller temperature sensors, A-11
 Controller Unique ID, 8-13, 12-21~22
 Controller Unique Identifier, 5-40, 7-43, 8-12, 12-16, 12-28
 Controller Voltage and Temperature terminal, 4-6, 6-10
 controller voltage monitors, A-11
 Controller/Logical Drive Shutdown, A-4
 Copy and Replace Drives expansion, 14-7
 Copy and Replace Procedure, 14-7
 Creating a Logical Drive, 5-6, 7-7
 Creating a Logical Volume, 5-10, 7-11
 creating a task schedule, 11-14
 Creating LUN Masks, 8-17
 Creating Primary and Secondary ID, 12-30
 Cursor Bar, 6-1
 CurSynCik, 6-9
 CurWid, 6-9
 Custom Inquiry Serial Number, A-12
 Cylinder Head Sector Mapping, 9-7, 9-13, 10-9
 Cylinder Ranges, 9-8
 Cylinder, 9-7

D

data bus setting, 8-1
 data cached, 12-18
 data inconsistency, 11-5
 Data Integrity, 11-1
 Data Rate, 7-35
 Date & Time, 5-42, 6-1, 7-44
 Deassert Reset on Failed Ctlr, 12-27
 Dedicated Communications loops, 8-14
 Dedicated Spare Drive, A-2
 default setting restoring, 5-33
 DefSynCik, 6-8
 DefWid, 6-9
 Deleting a Channel's ID, 5-27
 Deleting a Logical Drive, 5-16, 5-18, 7-19
 Deleting a Partition of a Logical Drive, 5-17
 Deleting a Partition, 7-19
 deleting a schedule, 11-14
 Deleting a SCSI ID, 7-29
 deleting channel ID, 5-27
 deleting partition of logical drive, 5-17, 7-19
 Deleting Spare Drive, 7-25, 7-26
 deleting spare drive, global or local, 5-25, 7-26
 Detect Clone plus Replace, 15-10
 Detect Only SMART, 15-6
 Detect Only, 15-9
 Detect and Perpetual Clone, 15-9
 detection of idle drive failure, 11-11
 Detection of Drive Hot Swap Followed by Auto Rebuild, 11-10
 Detection of Drive Hot Swap, 11-10
 Device Check Time, 10-1
 Device Qualifier Support, 9-4
 Device Support for Removable Media, 9-4~5
 Device Type, 9-4
 Disabling Password, 5-37, 7-39
 Disconnecting Support, 5-32, 7-34
 disk access delay time, 9-10
 Disk Array Parameters, 11-19
 disk mirroring, 1-4

Disk Reserved Space, 3-4, 5-7, 7-9
disk spanning, 1-3
disk striping with dedicated parity disk, 1-5
disk striping with mirroring, 1-4
disk striping, 1-4
Download Boot Record and Firmware, B-5
Download FW, B-4
Download FW/BR, B-3
drive + RCC, 12-4
Drive Entry, 7-25
drive failure, 1-6
Drive Fault detection, 11-1
Drive I/O timeout, 16-2, A-4
Drive Identification, A-3
Drive IDs Fibre Channel, 8-6
Drive Information, 7-45
Drive Low-level Format, 7-46
drive members, 2-8
Drive Motor Spin-up, A-4
Drive plus RCCOM, 8-14
Drive Predictable Failure Mode, 15-7
Drive Roaming, A-4
Drive side redundant loop, A-7
Drive Space Allocation, 7-19
Drive Swap Check Time, 11-10~11
drives, viewing and editing, 7-24
Drive-side Parameters Advanced config., 9-9
dual I/O paths, 12-8
Dual Loop, 8-11
dual-loop topology, A-7
dual-path, 11-5
Dynamic cache memory allocation, A-9
Dynamic Logical Drive Assignment, 11-7
Dynamic on-lining, A-11

E

Enclosure Devices, 10-2

enclosure implementation, 10-2
Enclosure Monitoring, 10-1
Environment management, A-9
Ethernet Requirements, 3-1
Event Logs terminal, 6-11
event logs viewing and editing, 4-6~7
event message, 1-5
Event Trigger Operations, 10-5
Event Trigger Option, 10-5, 11-4
Event Triggered Operations, 10-3, 11-2
Exclude, 8-21
Execution Period, 11-15
Expand Logical Drive, 14-7, 14-9
Expand Logical Volume, 14-11
expansion in Windows 2000, 14-1, 14-12
expansion interrupted, 14-6
Expansion Re-Striping, 14-3

F

F_ports, 8-11
Failback, 12-11, A-8
Failed Drive Detection, 11-10
Failed Drive Swap Detect, 1-9
failed link, 11-5
Failover Mode Configuration, 11-7
failover process, 12-21
Failover, A-8
Fan failure, 11-3
Fault Management, 2-10
Fault Prevention, 15-1
Fault Scenarios, 11-5
Fault-Tolerance, 12-1, 12-9
Fibre Channel Connection Options, 8-11
Fibre Channel Dual Loop, 8-11
Fibre Channel Parameters, 2-12
Fibre Chip, 8-5
filter entries, 8-22

Filter Type Include or Exclude, 8-21
 Filter Type, 8-21
 filtering mask, 8-16
 Firmware Binaries, B-3, B-5
 Firmware Binary, B-1, B-4
 Firmware Functionality, A-1
 Firmware Synchronization, 12-11, A-9
 Firmware Sync-version, B-2
 firmware upgrading, B-1
 FL_ports, 8-11
 flash memory, B-1
 flashing all but selected drives, 1-8
 flashing all drives, 1-8
 flashing selected drives, 1-8
 Forcing Controller Failover for Testing, 12-34
 format low-level, 5-43, 7-46

G

Gateway, 3-7
 Gauge Range, 6-1
 global spare drive deleting, 7-26
 global spare drive, 1-6, 5-15, A-2, 7-18
 GMT Greenwich Mean Time, 7-44
 Grouping Hard Drives, 12-6

H

hard drives, 7-8
 Hardware Faults, 11-2
 Head and Sector counts, 9-7
 Head Ranges, 9-8
 head sector count, 9-7
 hex number, 7-43, 8-13
 host application, 2-2, 2-10
 host channel setting, 5-26
 Host Channel, 7-31
 Host ID, 8-17
 Host ID/WWN Mask, 8-20

Host LUN Geometry, A-4
 host port ID, 12-8
 Host-ID/WWN Name List, 7-23
 Host-side and Drive-side Parameters
 Advanced Config, 9-1
 Host-side Maximum Queued I/O count, A-4
 Host-side Re-routing, 11-5, a-3
 http server, 3-5

I

I/O sorting, A-5
 I/O timeout, 9-10
 ID Mapping Status, 12-10
 ID Range, 8-20
 ID, deleting, 7-29
 Identify Drive, 5-19
 Identifying a Drive, 5-24, 7-25
 identifying drives, 1-8, 5-24
 idle drive failure detection, 11-11
 Immediate array availability, A-2
 inactive ID, 12-10
 In-band Fibre, 8-6, B-1~2
 in-band SCSI, 9-4
 Include, 8-21
 Initial Screen, 4-1, 6-1
 Initialization Mode, 5-10, 7-9
 initialization, 6-6
 initiator ID, 8-17
 Internet Protocol, 3-6
 Interruption to RAID expansion, 14-2
 IO channel diagnostics, A-4
 IP Address assignment, 3-6
 IP address, B-3~4
 Issue LIP, 7-35
 Iteration Count, 5-20, 7-22
 JBOD Subsystems, 11-6
 JBOD, 1-3

L

- LAN port, B-1
- LBA, 2-4, 7-21
- LCD Title Display Controller Name , 5-40, 7-41
- LD Initialization Writes, 11-20
- LD Rebuild Writes, 11-20
- level (0+1), 1-4
- level 0, 1-4
- level 1, 1-4
- level 3, 1-5
- level 5, 1-5
- Limitations on array config, 2-4
- Limitations on optimization modes, 5-2
- Limitations Redundant config, 12-17
- LIP, 5-35, 7-36, A-7
- Load sharing, A-9
- local spare drive deleting, 7-26
- Local Spare, 5-14, 6-3, 7-17
- logical drive assigning a name, 7-20
- Logical Drive Assignment, 7-9, 12-24, 12-30
- logical drive deleting, 7-19
- Logical Drive explained, 1-1
- Logical drive identification, A-1
- logical drive parity check, 5-19
- Logical Drive Parity Regeneration, 11-17
- Logical Drive Preferences, 5-6, 5-8, 7-8
- Logical Drive Status, 4-2, 6-4
- logical drive viewing drive members, 5-16, 7-18
- logical drive, explained, 1-1
- logical drive: assigning a name, 5-18
- Logical Unit to Host LUN Mapping, 8-18
- Logical Volume Assignment, 5-11
- Logical Volume Status terminal, 4-3, 6-5
- logical volume, 1-1, 1-11~17, 2-6
- loop failure detection, A-7
- loop ID, 8-12

- Low-level format, A-3
- LUN Applicability, 9-4
- LUN entries, 7-16
- LUN explained, 2-7
- LUN Filtering Configuration Procedure, 8-23
- LUN Filtering, 8-16, 8-22, 8-24, A-7
- LUN map, 8-16, 8-23
- LUN mapping, 7-23, 12-1
- LUN mappings, viewing and deleting, 5-22
- LUN Mask (ID Range) Configuration, 8-20
- LUN Mask, 8-20
- LUN, explained, 9-1
- LUN-0's only, 9-4
- LUNs per host ID, 9-4

M

- MAC addresses, 7-43
- Main Menu terminal, 6-2
- manual rebuild, 1-10
- Manual Setting redundant controller, 12-21
- Mapping a Logical Volume to Host LUNs, 5-13, 7-15
- Mapping LUNs, 12-8
- Mapping Partitions, 2-9
- mapping scheme, 8-19
- Mapping System Drives Redundant config., 12-8
- Mapping to Host LUNs Redundant config LCD, 12-25
- Mapping to Host LUNs, 12-2, 12-31
- Maximum Array Capacity, A-1
- Maximum array Number, A-1
- Maximum Concurrent Host LUN Connection, 9-2, A-4
- Maximum Drive Capacity, 5-7, 7-8
- maximum drive expand capacity, 14-9
- Maximum Drive Response Time, 16-1, A-4
- maximum latency, 16-2
- Maximum number of drives, A-1
- Maximum number of logical drives, A-1

Maximum number of logical volumes, A-1
Maximum number of LUNs per Host ID, A-1
Maximum number of LUNs, A-1
Maximum number of partitions, A-1
Maximum Queued I/O Count, 9-3
maximum synchronous transfer clock, 5-31, 7-33
Maximum Tag Count (Tag Command Queuing), 5-33, 7-34, 9-11
maximum transfer width, 5-32, 7-33
Media Scan Priority, 7-22
Media Scan, 5-20, 7-21, A-3
memory, 12-17
meta-filesystem, 3-6
mirroring, 1-4
Mode-1 RAID Expansion, A-6
Mode-2 RAID Expansion, A-6
Monitoring Thresholds, 10-6
motor spin-up, 9-9~10
Multi-Level RAID, 1-11, 1-17
multiple drive failures, 1-11
Multiple IDs, 7-15
multiple LUNs, 12-8
Multiple ranges, 8-21
Multiple target IDs, 7-29, 8-5
Multi-Threaded Operation, A-5
mute beeper, 5-36, 7-37

N

named adapter, 8-18
naming controller, 7-40~41
naming logical drive, 5-18
navigation keys - terminal emulation, 3-1, 3-3
NetMask, 3-7
Network Protocol, 2-13
NEW DRV, 6-6
node name, 8-13
Normal Drive Writes, 11-20

NRAID, 1-3
Number of Tags Reserved for each Host-LUN Connection, 9-2
NVRAM, A-4

O

Off-Line Mode Initialization, 5-9
onboard hub, 11-9
On-line Expansion, A-6
online initialization, 7-10
On-Line Mode Initialization, 5-9
Operational Theory, 2-7
Optimization for Random or Sequential I/O, 7-3
optimization mode, 2-3, 2-11, 5-1, 7-1
Out-of-band Configuration Redundant config, 12-15
Out-of-Band, 3-4~5
Overwrite Inconsistent Parity, 11-17

P

parameters cache, 5-2
parameters controller, 7-40
parity blocks, 7-21
parity check logical drive, 5-19
parity check, 5-32, 7-34
parity data, 16-1
Parity Error Event, 11-18
Parity regeneration, 11-17
Parity Synchronization, A-8
partition logical drive, deleting, 5-17, 7-19
Partitioning a Logical Drive/Logical Volume, 5-12, 7-13
Partitioning of Logical Units, 12-6
partitioning a logical volume, 1-15
Partitions the number of, 2-6
pass-through SCSI commands, 5-22, 7-23
password changing, 5-36, 7-37
password disabling, 5-37, 7-39
password setting a new, 7-38
Password Validation Timeout terminal, 7-42

Password Validation Timeout, 5-40
Periodic Auto-Detect Failure Drive Swap Check Time, 11-10
Periodic Auto-Detect, 11-10~11
periodic auto-detection of failed drive swap, 11-11
Periodic Cache Flush, 7-4, A-5
periodic check time, 10-1
Periodic Drive Check Time, 7-20, 11-11~2, 15-7
Periodic Drive Check, 15-8
periodic drive swap auto check, 11-11
Peripheral Device Status, 10-2
Peripheral Device Type Parameters for Various Operating Systems, 9-5
Peripheral Device Type Settings, 9-6, 9-13, 10-9
Peripheral Device Type, 9-4, 9-6, 9-13, 10-9
peripheral device, 9-5
Perpetual Clone, Clone Failing Drive, 15-3
Perpetual Clone SMART, 15-6
physical drives, 2-1
PID, 6-8
port name, 8-12, 8-13, 8-17, 8-19, 8-23, 12-22
Power supply failure, 11-3
Predictable Failure Test, 15-8
Preparing Controllers Redundant config, 12-15
Preventive schemes, 11-1
PriAgentAll, 3-8
Primary and Secondary ID, 12-7, 12-23, 12-30
primary controller setting SCSI ID/drive channel, 7-29
Primary controllers, 12-17, 12-24, 12-28, 12-30
Primary ID, 12-9, 12-12, 12-19, 12-25
Primary/secondary ID, setting, 5-27, 7-28
priorities, 16-2
PROCOMM, B-5

Q

Quick Installation, 4-1, 6-3

R

RAID (0+1), 1-11, 1-17
RAID (3+0), 1-17
RAID (5+0), 1-17
RAID 0, 1-4
RAID 1, 1-4
RAID 3, 1-5
RAID 5, 1-5
RAID Expansion Example, 14-1, 14-12
RAID expansion with logical volume, 1-15
RAID Expansion, 14-1
RAID Level, 5-6, 6-4
RAID levels definition of, 1-2
RAID Levels, 1-2, 2-4, A-1
RAIDWatch Manager, B-2
RC connecting, 12-19, 12-23
RC Standing By, 12-23
RCC Status, 12-35
RCC, 8-8
RCCOM, 6-8, 8-14, 12-19, 12-29
Read/Write Test, 7-47, A-3
Read-ahead, A-5
rebuild concurrent in RAID (0+1), 1-11
rebuild degrade mode, 7-21
rebuild logical drive, 5-18
Rebuild Priority, 5-16, 11-19
Rebuild Settings, 5-15, 7-17, 11-1
rebuild with spare, 1-9
Rebuild, 6-6
Rebuilding a Logical Drive, 5-18, 7-20
Redefining Channel Mode, 5-25, 7-27
Data flow re-directed, 11-5
Redundant Cache Coherency Channels (RCC), 8-3
Redundant Configuration Fibre interface, 12-3
Redundant Configuration SCSI interface, 12-2

redundant controller assigning logical drives to secondary, 12-24, 12-30
 redundant controller automatic config., 12-20, 12-27
 Redundant Controller Configuration, 12-9
 redundant controller explained, 12-9
 redundant controller if one fails, 12-26
 redundant controller manual config., 12-28
 redundant controller manual configuration of, 12-21
 redundant controller starting up, 12-23, 12-29
 Redundant Ctlr Failure Detected, 12-26
 Redundant Ctlr Function, 12-21~22
 Regenerate Parity, A-9
 Regenerating Logical Drive Parity, 5-19, 7-21
 Replace after Clone, Clone Failing Drive, 15-2
 Replace After Clone, 15-2
 replacement controller, 12-12, 12-26, 12-32
 Replacing a Failed Unit, 12-11
 Requirements and Limitations on redundant controller, 12-1
 Requirements for Redundant config., 12-1, 12-15
 Re-routed Data Path, 11-8
 Reserved Space, 3-6, 7-46
 reset controller, 5-37, 7-39
 Restore NVRAM from Disks, 5-39, 7-42
 Restoring the Default Setting, 5-33
 Rolling Firmware Upgrade, 12-12, A-9, B-1
 RS-232 configuration, 3-2
 RS-232 upgrading firmware via, B-4

S

S.E.S., 5-22
 S.M.A.R.T., 15-1, 15-5~6, 15-8, A-8, A-10
 safety range threshold, 10-7
 safety range, 10-6
 SAF-TE and S.E.S. Enclosure Monitoring, 10-1
 SAF-TE, 5-22, 10-1
 SAF-TE/S.E.S. polling period, A-11
 Sample Configuration LUN Filtering, 8-22
 SATA JBOD, 5-35, 7-36, 11-6
 Saving NVRAM to Disks, 5-38, 7-41
 Scan Mode, 11-15
 Scan Priority, 11-16
 Scan SCSI drive, 7-25
 Scanning New Drive, 5-23, 7-25
 Scatter / Gather, A-5
 Scheduled Maintenance, 11-13
 Scheduled Media Scan, A-9
 SCSI channel explained, 9-1
 SCSI channel terminator, 7-30
 SCSI Channel's Status, 6-8
 SCSI commands, pass-through, 7-23
 SCSI Drive Low-level Format, 5-44
 SCSI Drive Status, 4-4
 SCSI drive status, 6-6
 SCSI Drive Utilities, 5-43, 7-45
 SCSI Drive's Status terminal, 6-6
 SCSI ID, explained, 9-1
 SCSI I/O Timeout, 9-10
 SCSI motor spin-up, 9-9
 SCSI Parameters, 2-11
 Secondary Controller RS-232, 12-35
 secondary controller setting SCSI ID/drive channel for, 7-30
 Secondary controller, 12-12, 12-17, 12-24, 12-30
 Secondary ID, 12-10, 12-13, 12-19
 Sector Ranges, 9-7
 select "Controller Peripheral Device Configuration, 10-5
 sequential I/O, 7-6
 sequential writes, 7-5
 serial port setup, 3-1, 3-5
 Serial Port, 3-1
 Set Peripheral Device Entry, 10-5, 11-4, 12-16, 12-28
 Setting a Channel's Secondary ID, 5-28
 Setting a New Password terminal, 7-38

Setting a Primary Controller's SCSI ID, 7-29
Setting a SCSI Channel's ID, 5-26
Setting a SCSI Channel's Primary ID, 5-27
Setting a SCSI Channel's Terminator, 7-30
Setting a Secondary Controller's SCSI ID, 7-30
Setting a Transfer Speed, 7-31
Setting a Transfer Width, 7-31
Shared, 11-7
Shutdown Controller, 5-38, 7-39
SID, 6-8
single drive control, 1-3
slot number, 5-31, 7-25
S.M.A.R.T. attributes, 15-5, A-8
S.M.A.R.T. implementations, 15-5
source drive, 14-8, 15-2~3, 15-10
spanning, 1-3
Spare Drive Assignments, 5-7
Spare drive, 1-6, 1-11, 1-14, 2-4, 5-5, 6-7, 15-9
Spin-Up Parameters, 2-11~12
Spin-up, 9-9
SSH, 3-7, A-12
SSI Drive Utilities, 5-43
SSL, A-10
Standby, 6-6, 7-17, 15-1#
standby ID, 12-10
standby spare, 15-2
Start Time and Date, 11-15
streaming, 16-1
Stripe Size for different RAID levels, 5-2
Stripe Size, 5-8, 7-2, 7-10, A-1, A-5
Stripe Size Preset Values, 7-3
striping with interspersed parity, 1-5
striping with mirroring, 1-4~5
striping, 1-4
Sun Solaris, 9-7
Support Removable media, 9-4

Symptoms, controller failure, 12-14
Sync. cache channel, A-7
synchronized cache, 7-5, A-8
System Drive Mapping Redundant config, 12-4
System Drive Mapping, 8-1, 12-7
system drive mapping, 8-1
System Functions, 5-36, 7-37, B-5

T

Tag Command Queuing, 9-11, A-2
Tag Command Queuing, A-2
tag count maximum, 5-33, 7-34, 9-11,
Tags Reserved, A-4
target member drive, 15-3
target/drive channel, viewing and editing, 5-31
Task Schedule, 11-17
Task Scheduler Options, 11-14
Task Scheduler, 11-13
Telix, B-5
Temperature, ambient, 10-6
Temperature exceeds threshold, 11-3
terminal emulation terminology, 6-2
terminator jumpers, 5-29
terminator SCSI channel, 5-28, 7-30
Time Zone, 7-44
Timeout default, 9-11
timeout, 16-1
Traffic Distribution, 12-12~13
transfer clock maximum synchronous, 5-31, 7-33
transfer protocol, B-4
Transfer Rate Indicator, 6-1
Transfer Rate, 6-2
transfer speed setting, 5-29, 7-31
transfer width maximum, 7-33
transfer width setting, 5-30, 7-31
transfer width, 5-32

Transparent reset, A-3
Trigger Events, A-3
Trigger Thresholds, 10-6
Tunable Parameters, 2-10

U

unfinished writes, 12-18
unique ID, 6-4
upgrading firmware, B-1
upgrading using RAIDWatch, B-2
UPS, 10-7
used drive, 6-6, 15-2
User Configurable Geometry range, A-4
User-Assigned ID, 8-9

V

validation timeout, 7-38
Verification on Writes, 11-20, A-10
View and Edit Drive-Side Parameters
View and Edit Event Logs, 4-7
View and Edit Fibre Drive, 8-9
View and Edit Host-Side Parameters Fibre, 8-10
View Channel WWN, 8-8
view clone progress, 15-3
View Connected Drives, 5-5
View Device Port Name List, 8-9
View Drive Information, 7-45, 8-10
View Peripheral Device Status, 10-5
Viewing and Deleting LUN Mappings
Viewing and Editing Host LUNs, 5-22, 7-23
Viewing and Editing Logical Drive and Drive Members , 7-18
Viewing and Editing Logical Drives LCD, 5-16
Viewing and Editing Channels, 5-25, 7-27
Viewing and Editing Drives, 5-23, 7-24
viewing and editing SCSI ID/host channel, 7-28
Viewing and Editing IDs, 7-28

Viewing and Editing SCSI Target, 5-31, 7-32
viewing and editing SCSI target/drive channel, 7-32
viewing and redefining a channel mode, 5-25
Viewing or Deleting LUN Mappings, 7-23
Viewing the Connected Drives, 7-6
Voltage and Temperature Parameters, 10-6
volume capacity, 7-13
VT-100 Mode, 6-1
VT-100 setup, 3-1, 3-5
VT-100 terminal, 3-1, 3-3

W

Workflow, 12-4
Write Policy, 5-7, 5-10, 5-21, 6-1, 7-22, A-1
Write-Back cache, 5-21, 12-36
write-back mode, 12-19
Write-Back, 5-3
Write-Back/Write-Through Cache, 7-4
write-caching algorithm, 7-5
write-through caching, 16-1
Write-Through, 5-3
WWN Name List, 8-18
WWN node name, 7-43, 12-21~22
WWN table, A-7
WWPN, 8-23

Z

ZMODEM, B-4~6